



STP14NK50Z - STP14NK50ZFP STB14NK50Z-STB14NK50Z-1-STW14NK50Z

N-channel 500V - 0.34Ω - 14A TO-220/FP/D²PAK/I²PAK/TO-247
Zener-protected SuperMESH™ Power MOSFET

General features

Type	V _{DSS}	R _{DS(on)}	I _D	P _w
STP14NK50Z	500V	<0.38Ω	14A	150W
STP14NK50ZFP	500V	<0.38Ω	14A	35W
STB14NK50Z	500V	<0.38Ω	14A	150W
STB14NK50Z-1	500V	<0.38Ω	14A	150W
STW14NK50Z	500V	<0.38Ω	14A	150W

- Extremely high dv/dt capability
- 100% avalanche tested
- Gate charge minimized
- Very low intrinsic capacitances
- Very good manufacturing repeatability

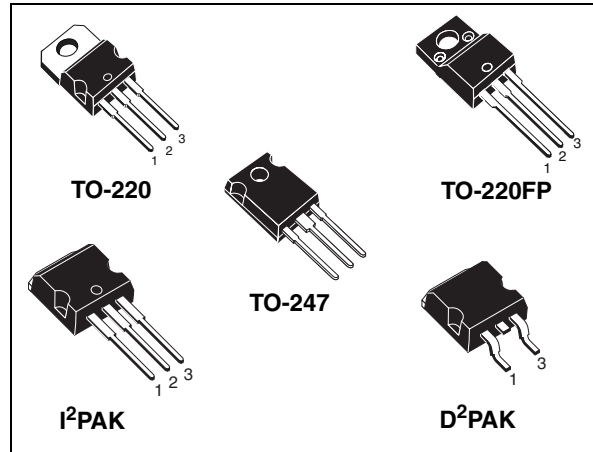

Description

The SuperMESH™ series is obtained through an extreme optimization of ST's well established strip-based PowerMESH™ layout. In addition to pushing on-resistance significantly down, special care is taken to ensure a very good dv/dt capability for the most demanding applications. Such series complements ST full range of high voltage MOSFETs including revolutionary MDmesh™ products.

Applications

- Switching application

Internal schematic diagram



Order codes

Part number	Marking	Package	Packaging
STP14NK50Z	P14NK50Z	TO-220	Tube
STP14NK50ZFP	P14NK50ZFP	TO-220FP	Tube
STB14NK50ZT4	B14NK50Z	D ² PAK	Tape & reel
STB14NK50Z-1	B14NK50Z	I ² PAK	Tube
STW14NK50Z	W14NK50Z	TO-247	Tube

Contents

1	Electrical ratings	3
2	Electrical characteristics	5
	2.1 Electrical characteristics (curves)	7
3	Test circuit	10
4	Package mechanical data	11
5	Packaging mechanical data	17
6	Revision history	18

1 Electrical ratings

Table 1. Absolute maximum ratings

Symbol	Parameter	Value			Unit
		TO-220 I ² PAK/D ² PAK	TO-220FP	TO-247	
V _{DS}	Drain-source voltage (V _{GS} = 0)	500			V
V _{DGR}	Drain-gate voltage (R _{GS} = 20KΩ)	500			V
V _{GS}	Gate-source voltage	± 30			V
I _D	Drain current (continuous) at T _C = 25°C	14	14 ⁽¹⁾	14	A
I _D	Drain current (continuous) at T _C =100°C	7.6	7.6 ⁽¹⁾	7.6	A
I _{DM} ⁽²⁾	Drain current (pulsed)	48	48 ⁽¹⁾	48	A
P _{TOT}	Total dissipation at T _C = 25°C	150	35	150	W
	Derating factor	1.20	0.28	1.20	W/°C
Vesd(G-S)	G-S ESD (HBM C=100pF, R=1.5kΩ)	4000			KV
dv/dt ⁽³⁾	Peak diode recovery voltage slope	4.5			V/ns
V _{ISO}	Insulation withstand voltage (DC)	--	2500		V
T _J T _{stg}	Operating junction temperature Storage temperature	-55 to 150			°C

- Limited only by maximum temperature allowed
- Pulse width limited by safe operating area
- I_{SD} ≤ 3A, di/dt ≤ 200A/μs, V_{DD} ≤ V_{(BR)DSS}, T_J ≤ T_{JMAX}

Table 2. Thermal data

Symbol	Parameter	Value				Unit
		TO-220 I ² PAK	D ² PAK	TO-220FP	TO-247	
R _{thj-case}	Thermal resistance junction-case Max	0.83		3.6	0.83	°C/ W
R _{thj-pcb}	Thermal resistance junction-pcb Max (1)		60			°C/ W
R _{thj-a}	Thermal resistance junction-ambient Max	62.5			50	°C/ W
T _I	Maximum lead temperature for soldering purpose	300				°C

- When mounted on minimum footprint

Table 3. Avalanche characteristics

Symbol	Parameter	Value	Unit
I_{AR}	Avalanche current, repetitive or not-repetitive (pulse width limited by Tj Max)	12	A
E_{AS}	Single pulse avalanche energy (starting Tj=25°C, Id=Iar, Vdd=50V)	400	mJ

Table 4. Gate-source zener diode

Symbol	Parameter	Test conditions	Min.	Typ.	Max.	Unit
BV_{GSO}	Gate-source breakdown voltage	Igs=±1mA (Open Drain)	30			V

1.1 Protection features og gate-to-source zener diodes

The built-in back-to-back Zener diodes have specifically been designed to enhance not only the device's ESD capability, but also to make them safely absorb possible voltage transients that may occasionally be applied from gate to source. In this respect the Zener voltage is appropriate to achieve an efficient and cost-effective intervention to protect the device's integrity. These integrated Zener diodes thus avoid the usage of external components.

2 Electrical characteristics

($T_{CASE}=25^{\circ}C$ unless otherwise specified)

Table 5. On/off states

Symbol	Parameter	Test conditions	Min.	Typ.	Max.	Unit
$V_{(BR)DSS}$	Drain-source breakdown voltage	$I_D = 1mA, V_{GS} = 0$	500			V
I_{DSS}	Zero gate voltage drain current ($V_{GS} = 0$)	$V_{DS} = \text{Max rating},$ $V_{DS} = \text{Max rating}, T_C = 125^{\circ}C$			1 50	μA μA
I_{GSS}	Gate body leakage current ($V_{DS} = 0$)	$V_{GS} = \pm 20V$			± 10	nA
$V_{GS(th)}$	Gate threshold voltage	$V_{DS} = V_{GS}, I_D = 100\mu A$	3	3.75	4.5	V
$R_{DS(on)}$	Static drain-source on resistance	$V_{GS} = 10V, I_D = 6A$		0.34	0.38	Ω

Table 6. Dynamic

Symbol	Parameter	Test conditions	Min.	Typ.	Max.	Unit
$g_{fs}^{(1)}$	Forward transconductance	$V_{DS} = 8V, I_D = 6A$		12		S
C_{iss} C_{oss} C_{rss}	Input capacitance Output capacitance Reverse transfer capacitance	$V_{DS} = 25V, f = 1 \text{ MHz}, V_{GS} = 0$		2000 238 55		pF pF pF
$C_{oss \text{ eq}}^{(2)}$	Equivalent output capacitance	$V_{GS} = 0, V_{DS} = 0V \text{ to } 400V$		150		pF
Q_g Q_{gs} Q_{gd}	Total gate charge Gate-source charge Gate-drain charge	$V_{DD} = 400V, I_D = 12A$ $V_{GS} = 10V$		69 12 31	92	nC nC nC

1. Pulsed: pulse duration=300 μs , duty cycle 1.5%

2. $C_{oss \text{ eq}}$ is defined as a constant equivalent capacitance giving the same charging time as C_{oss} when V_{DS} increases from 0 to 80% V_{DSS}

Table 7. Switching times

Symbol	Parameter	Test conditions	Min.	Typ.	Max.	Unit
$t_{d(on)}$ t_r	Turn-on delay time Rise time	$V_{DD} = 250 \text{ V}, I_D = 6A,$ $R_G = 4.7\Omega, V_{GS} = 10V$ (see Figure 19)		24 16		ns ns

Table 7. Switching times

$t_{d(off)}$	Turn-off delay time	$V_{DD}=250V, I_D=6A,$ $R_G=4.7\Omega, V_{GS}=10V$ (see Figure 19)		54		ns
t_f	Fall time			12		ns
$t_{r(Voff)}$	Off-voltage rise time	$V_{DD}=400V, I_D=12A,$ $R_G=4.7\Omega, V_{GS}=10V$ (see Figure 21)		9.5		ns
t_f	Fall time			9		ns
t_c	Cross-over time			20		ns

Table 8. Source drain diode

Symbol	Parameter	Test conditions	Min	Typ.	Max	Unit
I_{SD}	Source-drain current				12	A
$I_{SDM}^{(1)}$	Source-drain current (pulsed)				48	A
$V_{SD}^{(2)}$	Forward on voltage	$I_{SD}=12A, V_{GS}=0$			1.6	V
t_{rr}	Reverse recovery time	$I_{SD}=12A,$ $di/dt = 100A/\mu s,$ $V_{DD}=35V, T_J=150^\circ C$ (see Figure 21)		470		ns
Q_{rr}	Reverse recovery charge			3.1		μC
I_{RRM}	Reverse recovery current			13.2		A

1. Pulse width limited by safe operating area
2. Pulsed: pulse duration=300 μs , duty cycle 1.5%

2.1 Electrical characteristics (curves)

Figure 1. Safe operating area

Figure 2. Thermal impedance

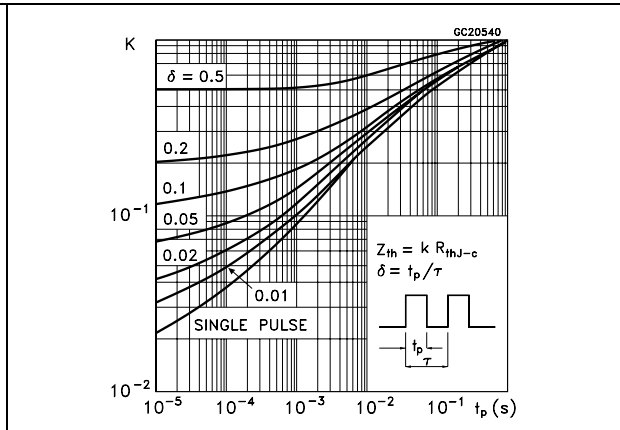
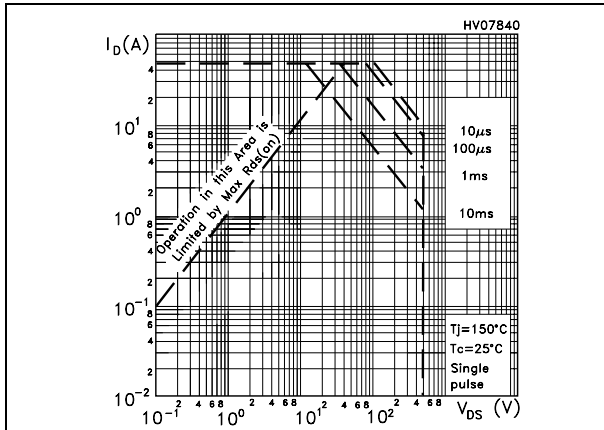

Figure 3. Safe operating area for TO-220FP

Figure 4. Thermal impedance for TO-220FP

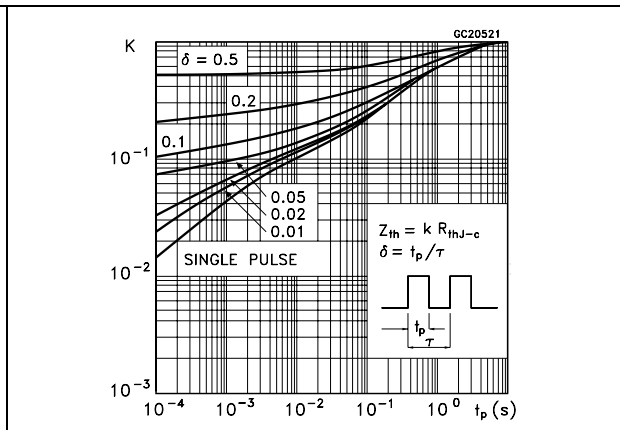
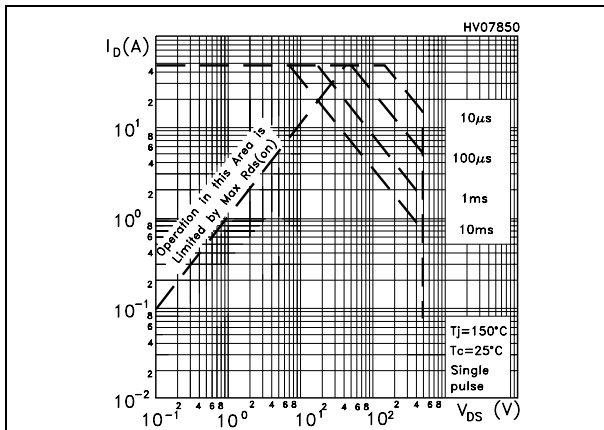

Figure 5. Safe operating area for TO-247

Figure 6. Thermal impedance for TO-247

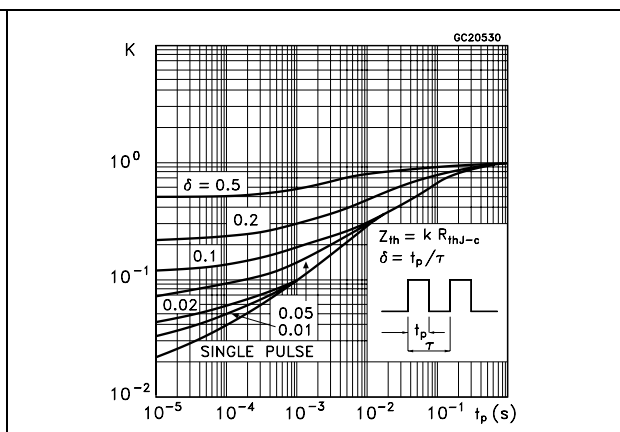
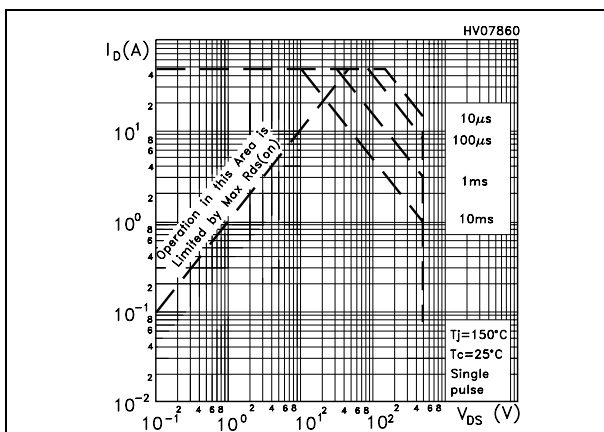

Figure 7. Output characteristics

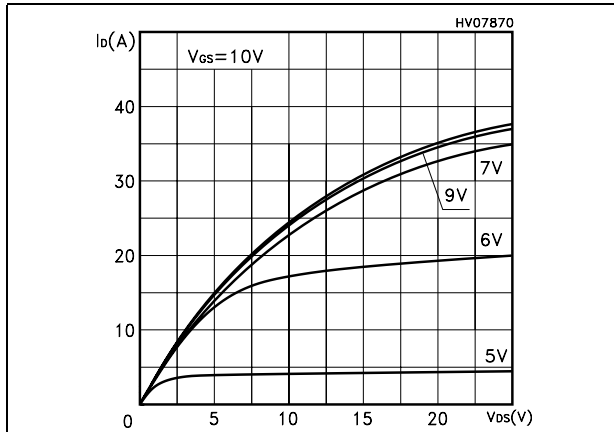

Figure 8. Transfer characteristics

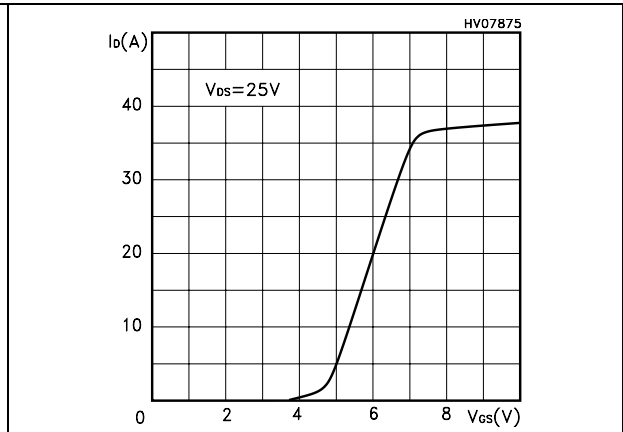

Figure 9. Transconductance

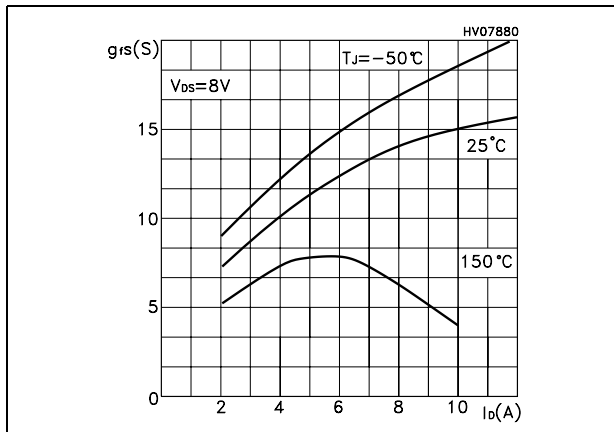

Figure 10. Static drain-source on resistance

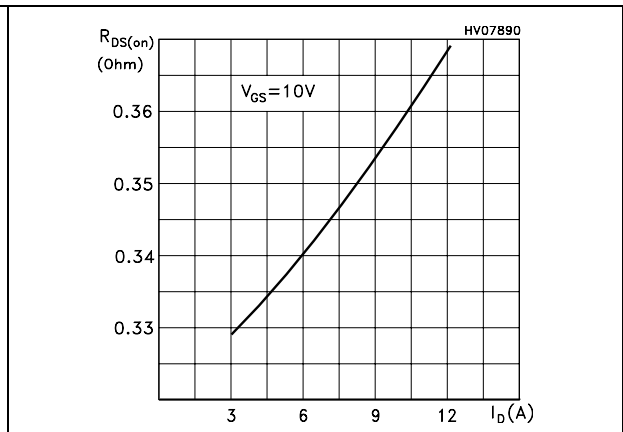

Figure 11. Gate charge vs gate-source voltage

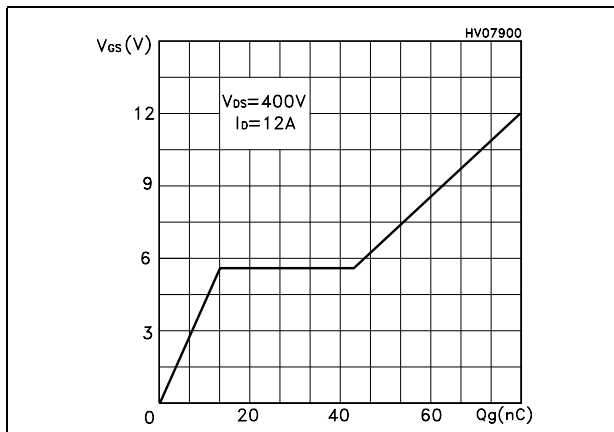

Figure 12. Capacitance variations

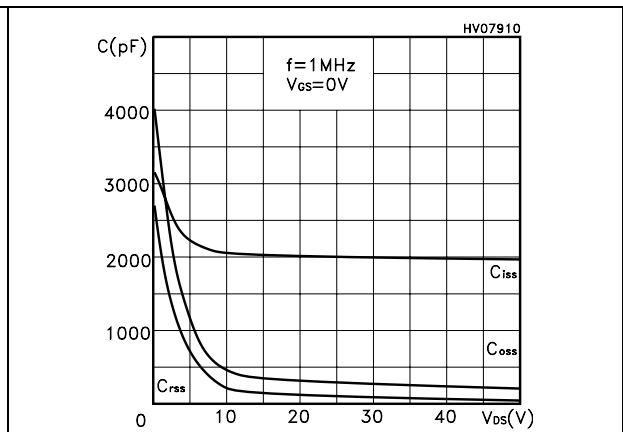

Figure 13. Normalized gate threshold voltage vs temperature

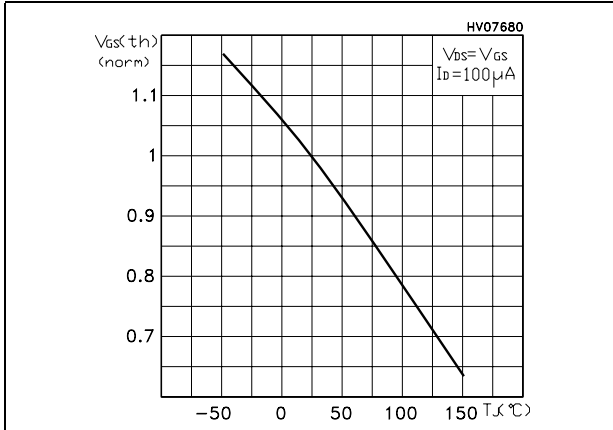

Figure 14. Normalized on resistance vs temperature

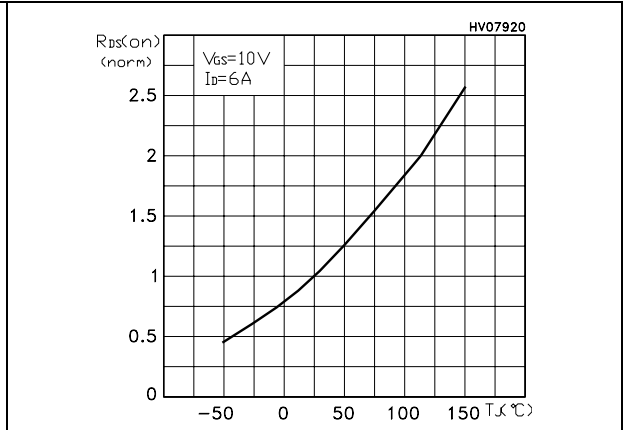

Figure 15. Source-drain diode forward characteristics

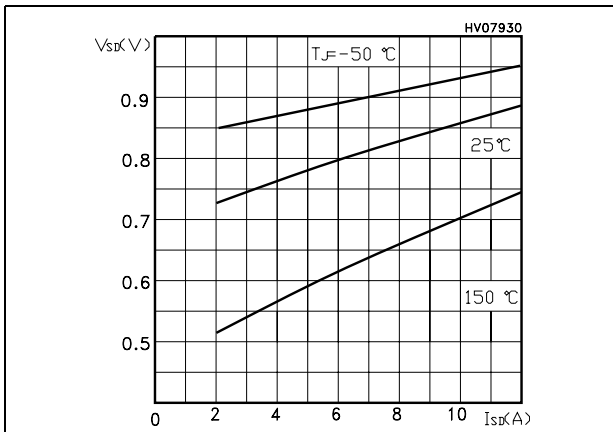

Figure 16. Normalized B_VDSS vs temperature

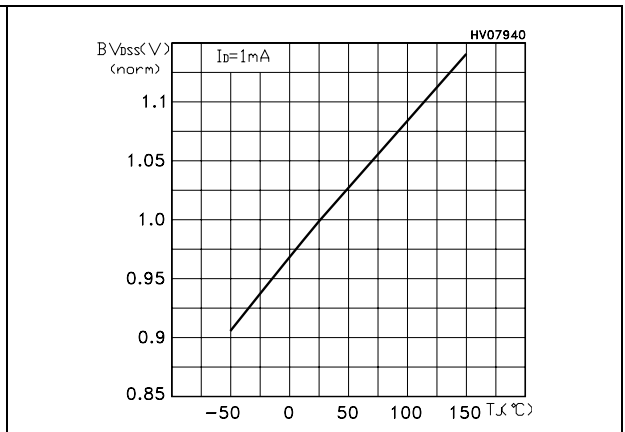

Figure 17. Normalized B_Vgso vs temperature

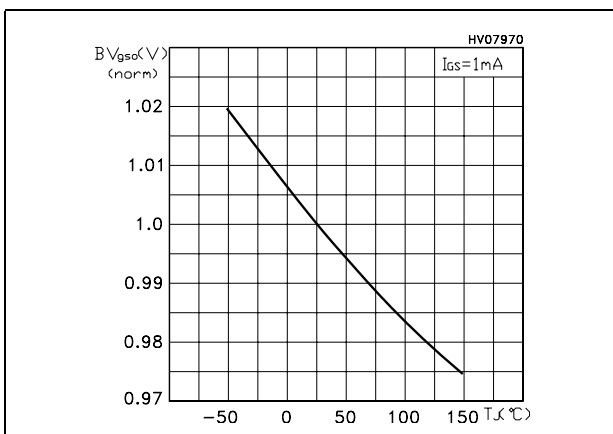
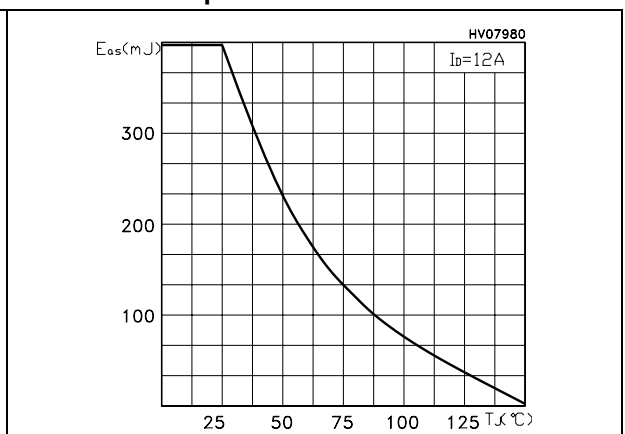

Figure 18. Maximum avalanche energy vs temperature



3 Test circuit

Figure 19. Switching times test circuit for resistive load

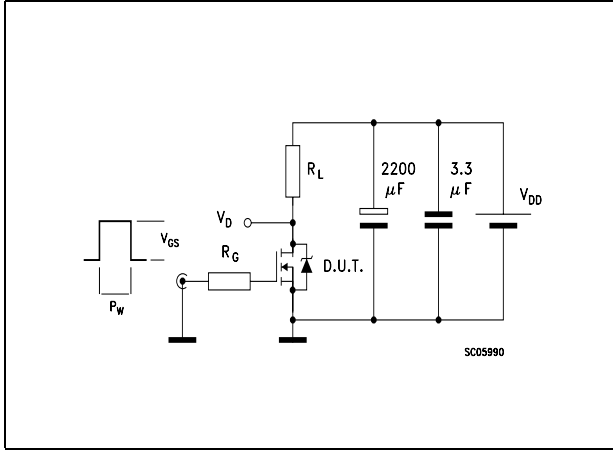

Figure 20. Gate charge test circuit



Figure 21. Test circuit for inductive load switching and diode recovery times



Figure 22. Unclamped Inductive load test circuit



Figure 23. Unclamped inductive waveform

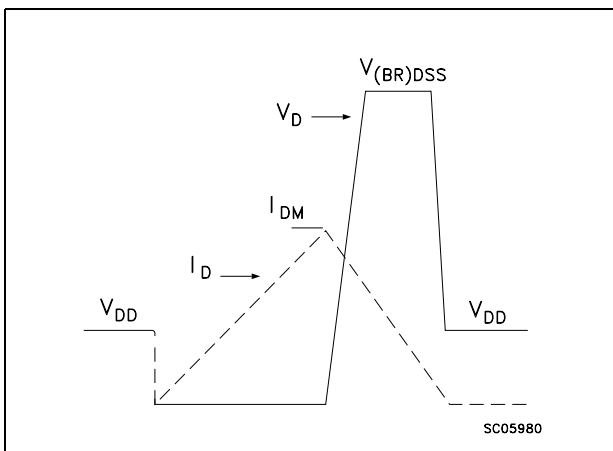
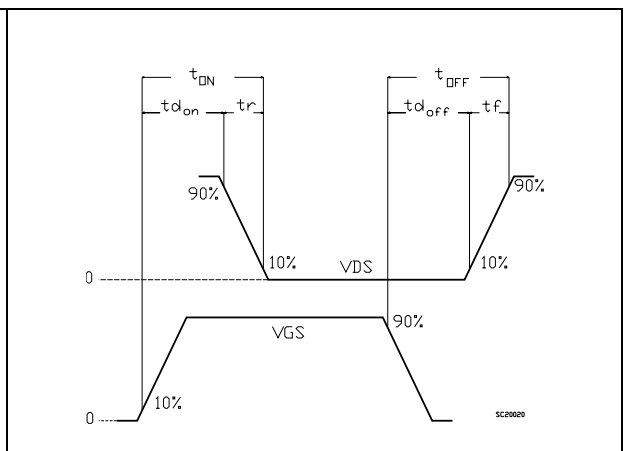

Figure 24. Switching time waveform



4 Package mechanical data

In order to meet environmental requirements, ST offers these devices in ECOPACK® packages. These packages have a Lead-free second level interconnect . The category of second level interconnect is marked on the package and on the inner box label, in compliance with JEDEC Standard JESD97. The maximum ratings related to soldering conditions are also marked on the inner box label. ECOPACK is an ST trademark. ECOPACK specifications are available at: www.st.com

TO-220 MECHANICAL DATA

DIM.	mm.			inch		
	MIN.	TYP.	MAX.	MIN.	TYP.	MAX.
A	4.40		4.60	0.173		0.181
b	0.61		0.88	0.024		0.034
b1	1.15		1.70	0.045		0.066
c	0.49		0.70	0.019		0.027
D	15.25		15.75	0.60		0.620
E	10		10.40	0.393		0.409
e	2.40		2.70	0.094		0.106
e1	4.95		5.15	0.194		0.202
F	1.23		1.32	0.048		0.052
H1	6.20		6.60	0.244		0.256
J1	2.40		2.72	0.094		0.107
L	13		14	0.511		0.551
L1	3.50		3.93	0.137		0.154
L20		16.40			0.645	
L30		28.90			1.137	
øP	3.75		3.85	0.147		0.151
Q	2.65		2.95	0.104		0.116

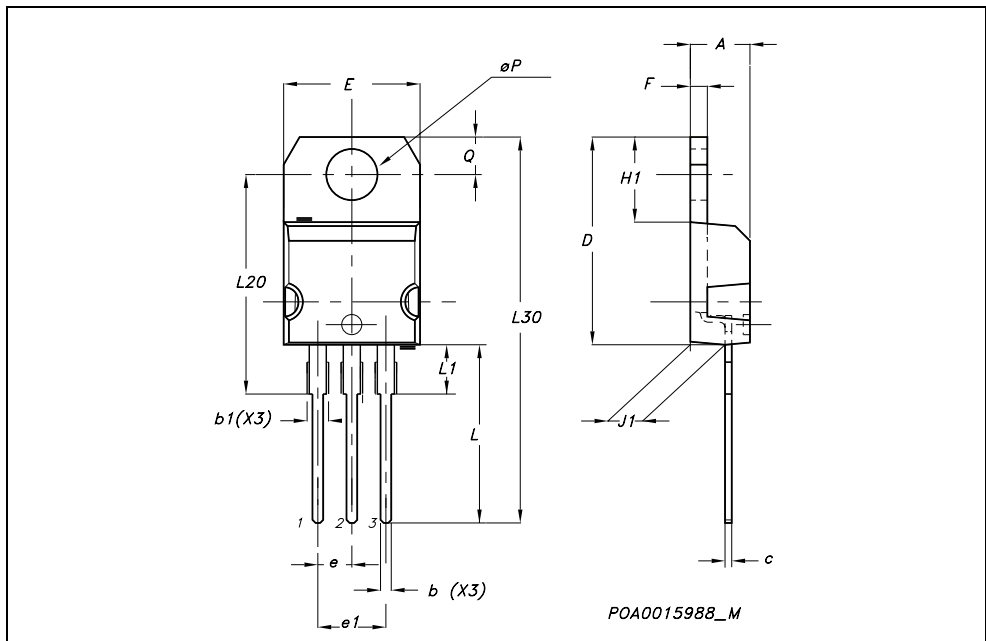

TO-220FP MECHANICAL DATA

DIM.	mm.			inch		
	MIN.	TYP	MAX.	MIN.	TYP.	MAX.
A	4.4		4.6	0.173		0.181
B	2.5		2.7	0.098		0.106
D	2.5		2.75	0.098		0.108
E	0.45		0.7	0.017		0.027
F	0.75		1	0.030		0.039
F1	1.15		1.7	0.045		0.067
F2	1.15		1.7	0.045		0.067
G	4.95		5.2	0.195		0.204
G1	2.4		2.7	0.094		0.106
H	10		10.4	0.393		0.409
L2		16			0.630	
L3	28.6		30.6	1.126		1.204
L4	9.8		10.6	.0385		0.417
L5	2.9		3.6	0.114		0.141
L6	15.9		16.4	0.626		0.645
L7	9		9.3	0.354		0.366
Ø	3		3.2	0.118		0.126

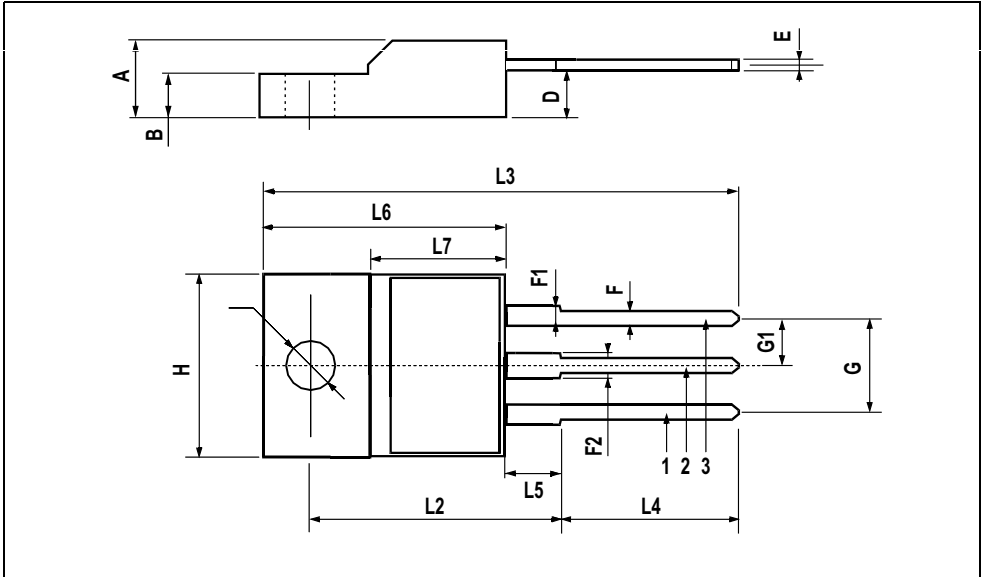

D²PAK MECHANICAL DATA

DIM.	mm.			inch		
	MIN.	TYP	MAX.	MIN.	TYP.	MAX.
A	4.4		4.6	0.173		0.181
A1	2.49		2.69	0.098		0.106
A2	0.03		0.23	0.001		0.009
B	0.7		0.93	0.027		0.036
B2	1.14		1.7	0.044		0.067
C	0.45		0.6	0.017		0.023
C2	1.23		1.36	0.048		0.053
D	8.95		9.35	0.352		0.368
D1		8			0.315	
E	10		10.4	0.393		
E1		8.5			0.334	
G	4.88		5.28	0.192		0.208
L	15		15.85	0.590		0.625
L2	1.27		1.4	0.050		0.055
L3	1.4		1.75	0.055		0.068
M	2.4		3.2	0.094		0.126
R		0.4			0.015	
V2	0°		4°			



TO-262 (I²PAK) MECHANICAL DATA

DIM.	mm.			inch		
	MIN.	TYP.	MAX.	MIN.	TYP.	MAX.
A	4.40		4.60	0.173		0.181
A1	2.40		2.72	0.094		0.107
b	0.61		0.88	0.024		0.034
b1	1.14		1.70	0.044		0.066
c	0.49		0.70	0.019		0.027
c2	1.23		1.32	0.048		0.052
D	8.95		9.35	0.352		0.368
e	2.40		2.70	0.094		0.106
e1	4.95		5.15	0.194		0.202
E	10		10.40	0.393		0.410
L	13		14	0.511		0.551
L1	3.50		3.93	0.137		0.154
L2	1.27		1.40	0.050		0.055

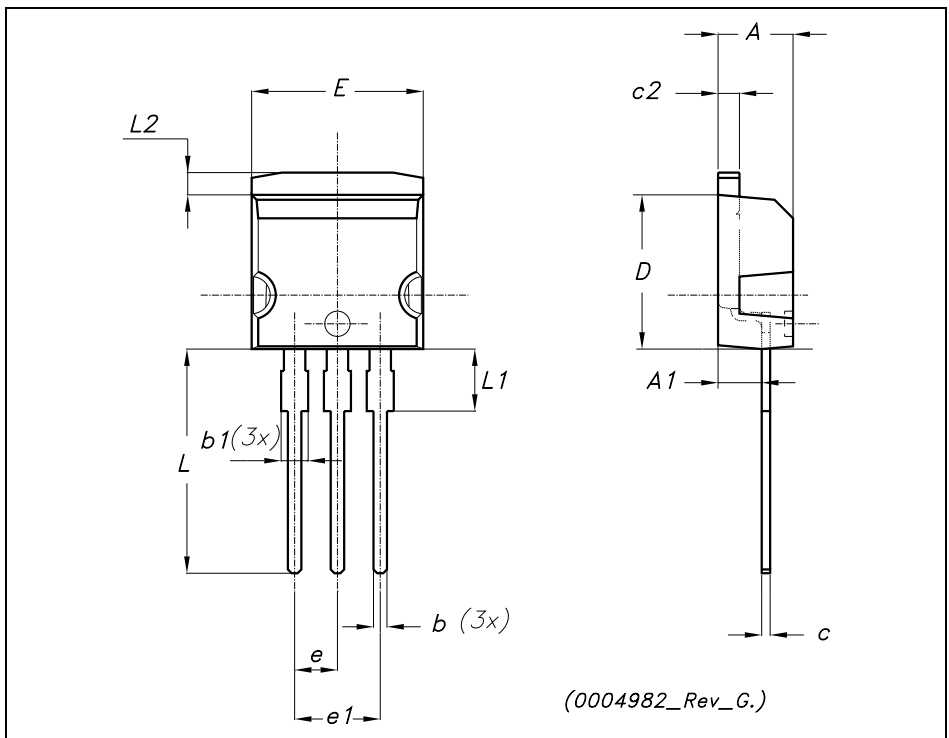

TO-247 MECHANICAL DATA

DIM.	mm.			inch		
	MIN.	TYP.	MAX.	MIN.	TYP.	MAX.
A	4.85		5.15	0.19		0.20
A1	2.20		2.60	0.086		0.102
b	1.0		1.40	0.039		0.055
b1	2.0		2.40	0.079		0.094
b2	3.0		3.40	0.118		0.134
c	0.40		0.80	0.015		0.03
D	19.85		20.15	0.781		0.793
E	15.45		15.75	0.608		0.620
e		5.45			0.214	
L	14.20		14.80	0.560		0.582
L1	3.70		4.30	0.14		0.17
L2		18.50			0.728	
øP	3.55		3.65	0.140		0.143
øR	4.50		5.50	0.177		0.216
S		5.50			0.216	

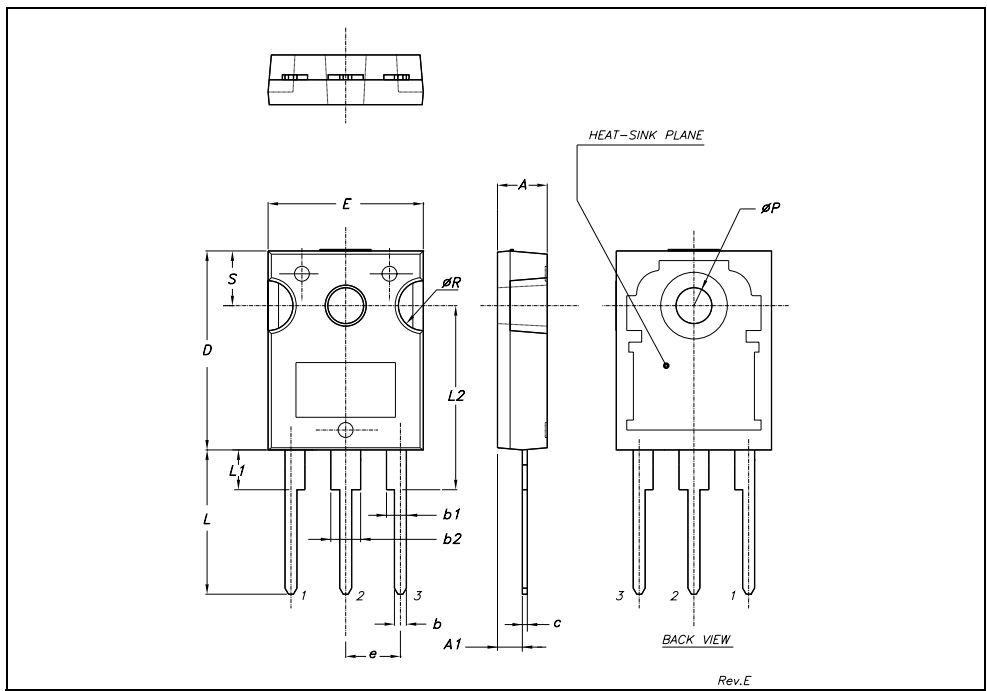

5 Packaging mechanical data

D²PAK FOOTPRINT

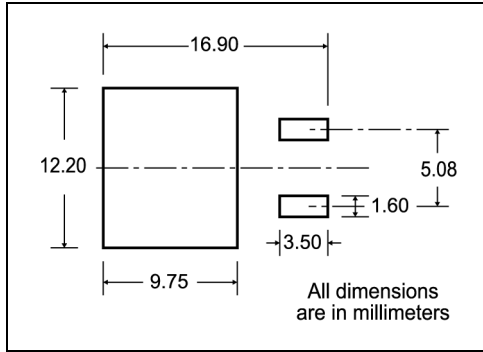

TAPE AND REEL SHIPMENT

40 mm min. Access hole at slot location

Full radius

Tape slot in core for tape start 2.5mm min. width

G measured at hub

REEL MECHANICAL DATA

DIM.	mm		inch	
	MIN.	MAX.	MIN.	MAX.
A		330		12.992
B	1.5		0.059	
C	12.8	13.2	0.504	0.520
D	20.2		0.795	
G	24.4	26.4	0.960	1.039
N	100		3.937	
T		30.4		1.197

BASE QTY	BULK QTY
1000	1000

TAPE MECHANICAL DATA

DIM.	mm		inch	
	MIN.	MAX.	MIN.	MAX.
A0	10.5	10.7	0.413	0.421
B0	15.7	15.9	0.618	0.626
D	1.5	1.6	0.059	0.063
D1	1.59	1.61	0.062	0.063
E	1.65	1.85	0.065	0.073
F	11.4	11.6	0.449	0.456
K0	4.8	5.0	0.189	0.197
P0	3.9	4.1	0.153	0.161
P1	11.9	12.1	0.468	0.476
P2	1.9	2.1	0.075	0.082
R	50		1.574	
T	0.25	0.35	0.0098	0.0137
W	23.7	24.3	0.933	0.956

10 pitches cumulative tolerance on tape +/- 0.2 mm

Center line of cavity

User Direction of Feed

FEED DIRECTION

Bending radius R min.

* on sales type

6 Revision history

Table 9. Revision history

Date	Revision	Changes
21-Jun-2004	2	Complete version with curves
26-Jul-2006	3	New template, no content change

Please Read Carefully:

Information in this document is provided solely in connection with ST products. STMicroelectronics NV and its subsidiaries ("ST") reserve the right to make changes, corrections, modifications or improvements, to this document, and the products and services described herein at any time, without notice.

All ST products are sold pursuant to ST's terms and conditions of sale.

Purchasers are solely responsible for the choice, selection and use of the ST products and services described herein, and ST assumes no liability whatsoever relating to the choice, selection or use of the ST products and services described herein.

No license, express or implied, by estoppel or otherwise, to any intellectual property rights is granted under this document. If any part of this document refers to any third party products or services it shall not be deemed a license grant by ST for the use of such third party products or services, or any intellectual property contained therein or considered as a warranty covering the use in any manner whatsoever of such third party products or services or any intellectual property contained therein.

UNLESS OTHERWISE SET FORTH IN ST'S TERMS AND CONDITIONS OF SALE ST DISCLAIMS ANY EXPRESS OR IMPLIED WARRANTY WITH RESPECT TO THE USE AND/OR SALE OF ST PRODUCTS INCLUDING WITHOUT LIMITATION IMPLIED WARRANTIES OF MERCHANTABILITY, FITNESS FOR A PARTICULAR PURPOSE (AND THEIR EQUIVALENTS UNDER THE LAWS OF ANY JURISDICTION), OR INFRINGEMENT OF ANY PATENT, COPYRIGHT OR OTHER INTELLECTUAL PROPERTY RIGHT.

UNLESS EXPRESSLY APPROVED IN WRITING BY AN AUTHORIZED ST REPRESENTATIVE, ST PRODUCTS ARE NOT RECOMMENDED, AUTHORIZED OR WARRANTED FOR USE IN MILITARY, AIR CRAFT, SPACE, LIFE SAVING, OR LIFE SUSTAINING APPLICATIONS, NOR IN PRODUCTS OR SYSTEMS WHERE FAILURE OR MALFUNCTION MAY RESULT IN PERSONAL INJURY, DEATH, OR SEVERE PROPERTY OR ENVIRONMENTAL DAMAGE. ST PRODUCTS WHICH ARE NOT SPECIFIED AS "AUTOMOTIVE GRADE" MAY ONLY BE USED IN AUTOMOTIVE APPLICATIONS AT USER'S OWN RISK.

Resale of ST products with provisions different from the statements and/or technical features set forth in this document shall immediately void any warranty granted by ST for the ST product or service described herein and shall not create or extend in any manner whatsoever, any liability of ST.

ST and the ST logo are trademarks or registered trademarks of ST in various countries.

Information in this document supersedes and replaces all information previously supplied.

The ST logo is a registered trademark of STMicroelectronics. All other names are the property of their respective owners.

© 2006 STMicroelectronics - All rights reserved

STMicroelectronics group of companies

Australia - Belgium - Brazil - Canada - China - Czech Republic - Finland - France - Germany - Hong Kong - India - Israel - Italy - Japan - Malaysia - Malta - Morocco - Singapore - Spain - Sweden - Switzerland - United Kingdom - United States of America

www.st.com



Mouser Electronics

Authorized Distributor

Click to View Pricing, Inventory, Delivery & Lifecycle Information:

[STMicroelectronics:](#)

[STP14NK50Z](#) [STP14NK50ZFP](#) [STB14NK50ZT4](#) [STW14NK50Z](#)