

AN-2192 LM3492 12VAC, 7W LED Driver for AR111 Application

1 Introduction

The LM3492 demonstration board included in this package is designed for converting nominal 12VAC from electronic transformer output to drive seven series connected LEDs at 360mA average current. The end user can directly light up a LED string through the demonstration board from an electronic transformer to test out the performance. With the demonstration board, the LED string not only runs at a constant current but also flicker free operation. The LM3492 switching frequency is set at a nominal 1MHz. This is a two layer board using the top layer for component placement and both layers for trace routing. A bill of materials describes the parts used on the demonstration board. A schematic and layouts have also been included. For detailed information regarding the LM3492 device, please refer to *LM3492/LM3492Q Two-Channel Individual Dimmable LED Driver with Boost Converter and Fast Current Regulator* ([SNVS656](#)).

2 Adaptive Peak Current Limit

Thanks to the Adaptive Peak Current Limit circuitry, the compatibility of the demonstration board with electronic transformers is greatly enhanced. This circuitry minimizes the peak current limit dynamically according to the loading and input profile. Thus, the input current is continuous throughout every AC half-cycle.

3 Key Features

- Drop-in compatible with electronic transformers
- Excellent compatibility with various electronic transformers
- Regulated LED current
- Flicker free operation

4 Applications

- AR111 Retrofit
- Industrial and Commercial Lighting
- Residential Lighting

5 Operating Conditions

- $V_{IN} = 12VAC$ from electronic transformer
- Seven series connected single-die white LEDs
- $I_{LED} = 360\text{ mA}$

6 Demonstration Board Schematic

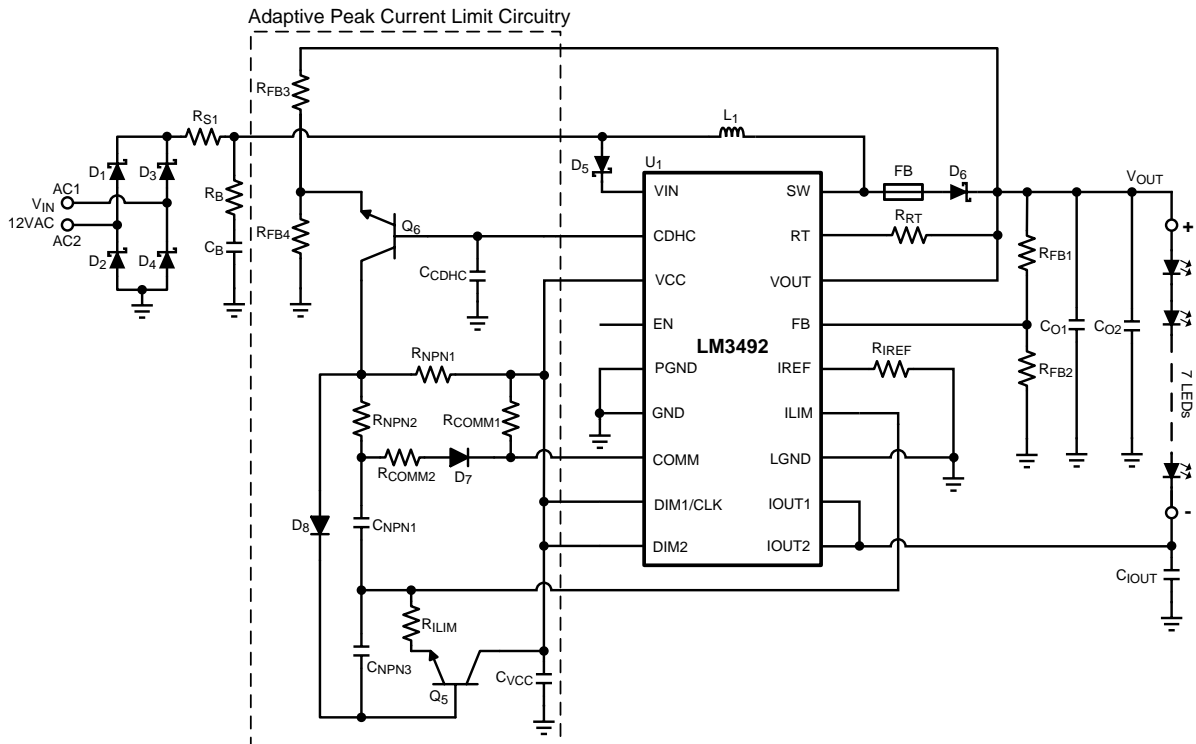
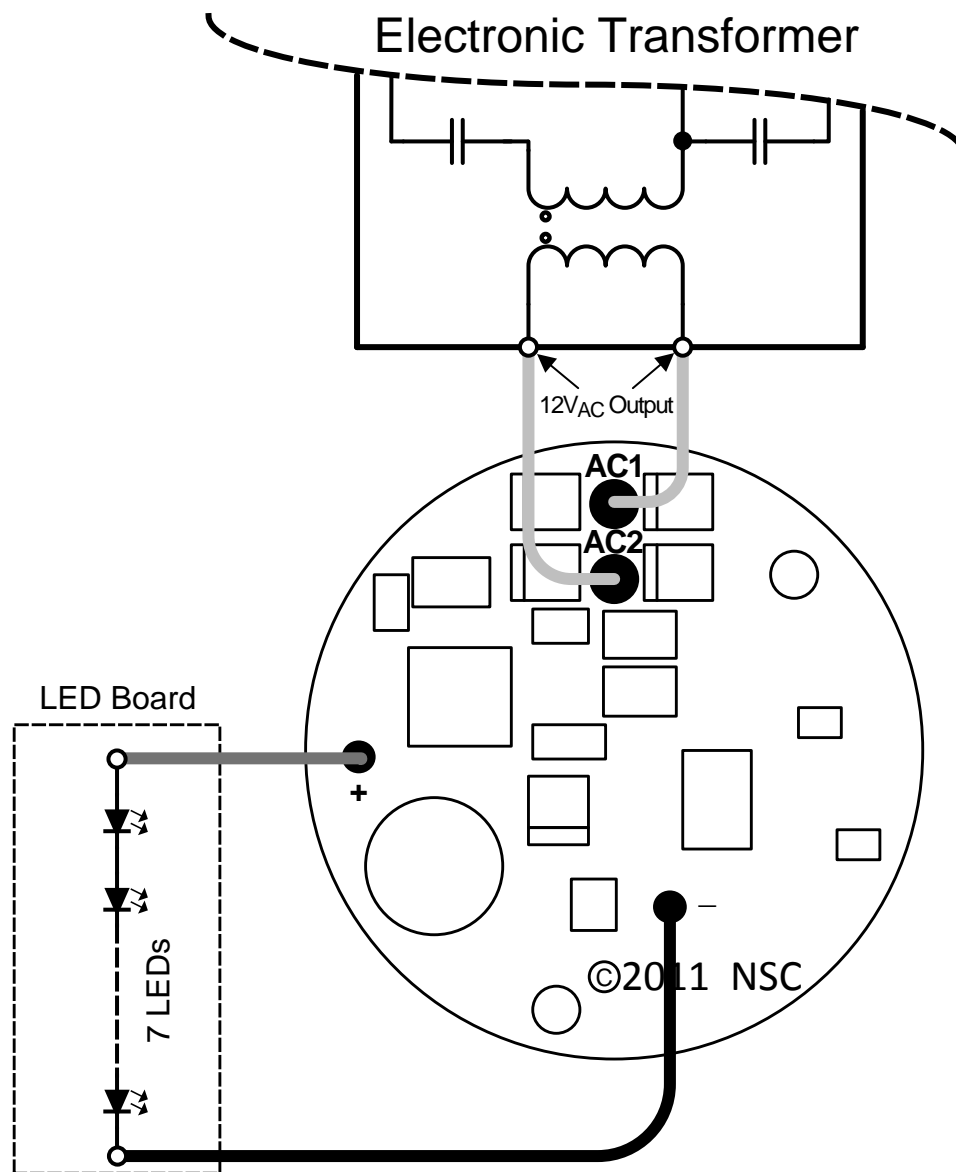

Figure 1. Demonstration Board Schematic Diagram

7 Bill of Materials

Ref Designators	Descriptions	Packages	Manufacturers	Manufacturer Part #
U1	LM3492	HTSSOP-20	TI	LM3492
L1	Power Inductor, 15uH		Sumida	CDRH8D38NP-150N
Q5, Q6	NPN, 40V, 200mA	SOT-23	Central Semi	CMPT3904
D1, D2, D3, D4, D6	Schottky Diode, 60V, 3A	SMA	Diodes	B360A-13-F
D5, D7, D8	Schottky Diode, 30V, 100mA	SOD-523	Central Semi	CMOSH-3
CB	Tantalum Cap., 2.2 μ F, 25V	1210	Vishay	293D225X0025B2TE3
CO1	Electrolytic Cap., 330 μ F, 35V		Panasonic	EEU-FM1V331L
CO2	MLCC, X7R, 2.2 μ F, 50V	1206	Murata	GCM31CR71H225KA55L
CVCC, CCDHC, CIOUT	MLCC, 4.7 μ F, 6.3V, X5R	0603	Murata	GRM188R60J475KE19D
CNPN1	MLCC, 2.2 μ F, 6.3V, X5R	0603	Murata	GRM185R60J225KE26D
CNPN3	MLCC, 1 μ F, 10V, X5R	0603	Murata	GRM188R61A105KA61D
FB	Ferrite Bead 30ohm@100 MHz	0805	Murata	BLM21PG300SN1D
RS1	Chip Resistor, 0 Ω , 0.5W	1206	Vishay	CRCW12060000Z0EA
RB	Chip Resistor, 4.12 Ω , 1%	1206	Vishay	CRCW12064R12FKEA
RIREF	Chip Resistor, 6.19 k Ω , 1%	0603	Vishay	CRCW06036K19FKEA
RILIM	Chip Resistor, 2.8 k Ω , 1%	0603	Vishay	CRCW06032K80FKEA
RNPN1	Chip Resistor, 100 k Ω , 1%	0603	Vishay	CRCW0603100KFKEA
RNPN2	Chip Resistor, 3.09 k Ω , 1%	0603	Vishay	CRCW06033K09FKEA
RRT	Chip Resistor, 976 k Ω , 1%	0603	Vishay	CRCW0603976KFKEA
RCOMM1	Chip Resistor, 52.3 k Ω , 1%	0603	Vishay	CRCW060352K3FKEA
RCOMM2	Chip Resistor, 7.87 k Ω , 1%	0603	Vishay	CRCW06037K87FKEA
RFB1, RFB3	Chip Resistor, 63.4 k Ω , 1%	0603	Vishay	CRCW060363K4FKEA
RFB2, RFB4	Chip Resistor, 5.23 k Ω , 1%	0603	Vishay	CRCW06035K23FKEA
Wire AC1, Wire AC2	Green, AWG#20, L = 10cm, 105°C			
Wire +	Red, AWG#22, L = 10cm, 105°C			
Wire -	Black, AWG#22, L = 10cm, 105°C			

8 Demonstration Board Wiring Overview



Terminal Designation	Description
AC1, AC2	12V _{AC} supply from electronic transformer
+	LED string positive (+ve) connection
-	LED string negative (-ve) connection

Figure 2. Evaluation Setup Connection Diagram

9 Typical Performance and Waveform

All curves taken at $V_{IN} = 8\sim 14VAC$, 50Hz for driving a LED string (Philips Lumileds Luxeon Rebel White LED) under $T_A = 25^\circ C$, unless otherwise specified. Details of Modification A and Modification B are shown in the Modification List table.

The waveform taken at $V_{LINE} = 220VAC$, 50Hz with configuration according to Figure 2 with OSRAM ET-PARROT electronic transformer for driving seven series connected LEDs (Philips Lumileds Luxeon Rebel White LED) with 20V forward voltage under $T_A = 25^\circ C$.

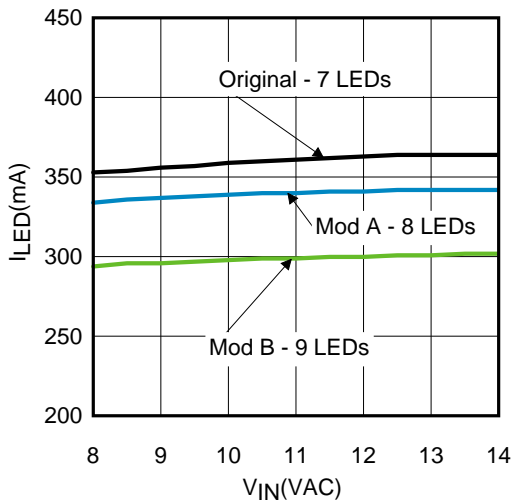

Figure 3. LED Current vs V_{IN} @ $T_A=25^\circ C$

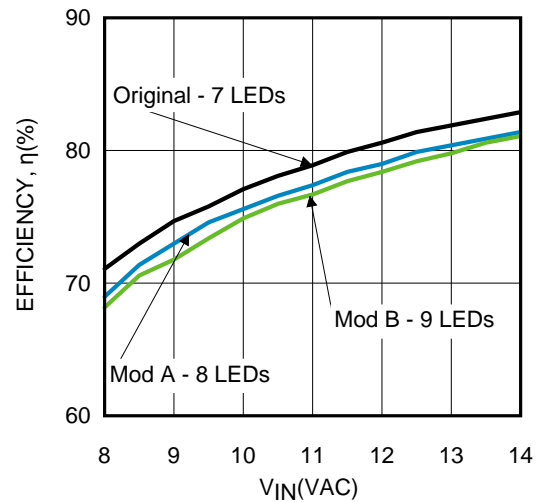

Figure 4. Efficiency vs V_{IN} @ $T_A=25^\circ C$

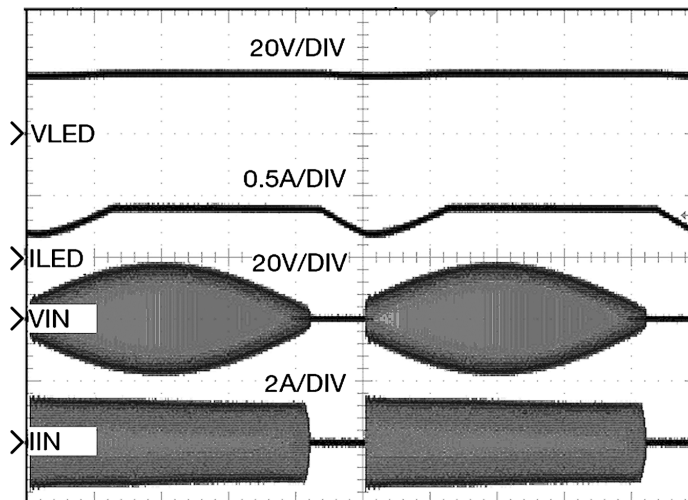

Figure 5. Steady State Operation (2ms/DIV)

Modification List

Version	# of LEDs	LED Current	RFB2, RFB4	RREF
Original	7	360mA	5.23k Ω	6.19k Ω
Mod A	8	340mA	4.53k Ω	6.65k Ω
Mod B	9	300mA	4.12k Ω	7.68k Ω

10 Compatible Electronic Transformer List

All tests were conducted at $V_{LINE} = 220VAC$, 50Hz with configuration according to [Figure 2](#) for driving seven series connected LEDs (Philips Lumileds Luxeon Rebel White LED) with 20V forward voltage under $T_A = 25^\circ C$, unless otherwise specified.

This Demonstration Board was designed to operate with various electronic transformers. The following listed electronic transformers were tested with and compatible with the demonstration board. The demonstration board is not ensured to be compatible with the listed electronic transformers owing to the manufacturing variation of electronic transformers.

- PHILIPS ET-E 50
- PHILIPS ET-E 60
- OSRAM ET-PARROT
- OSRAM ET-P60
- OSRAM ET-Z60
- OPPLÉ DB35-220
- OPPLÉ DB602-220
- NVC ET50S
- CDN CS60

11 PCB Layout

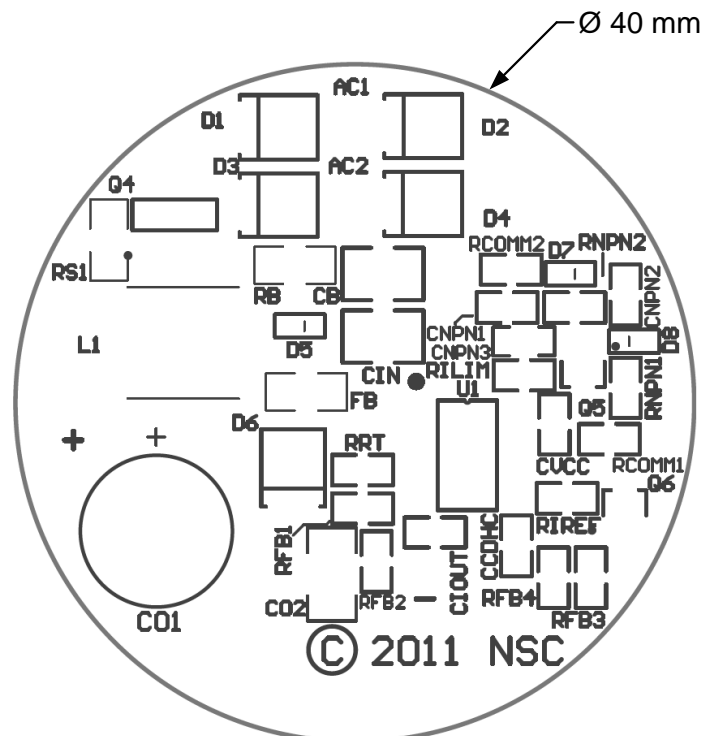

Figure 6. Top Overlay

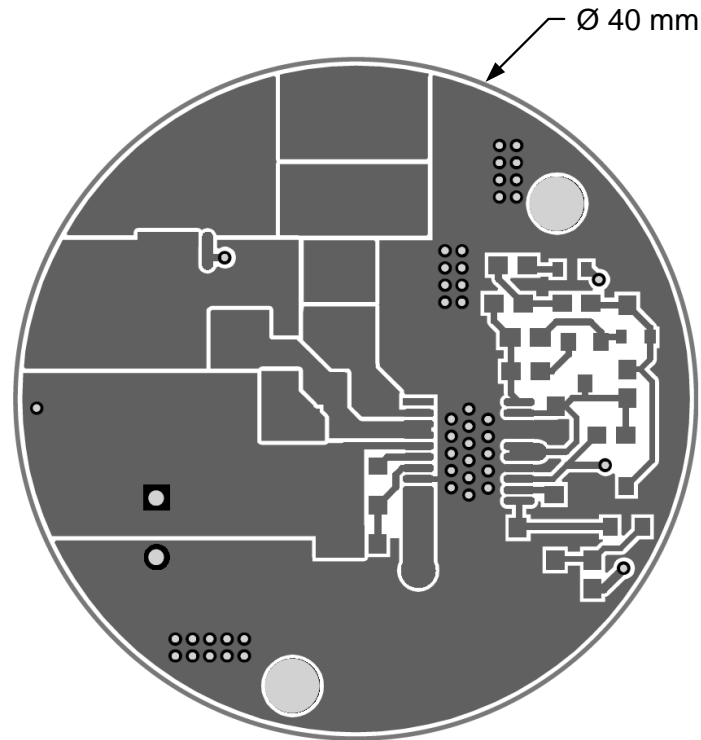

Figure 7. Top Layer



Figure 8. Bottom Overlay

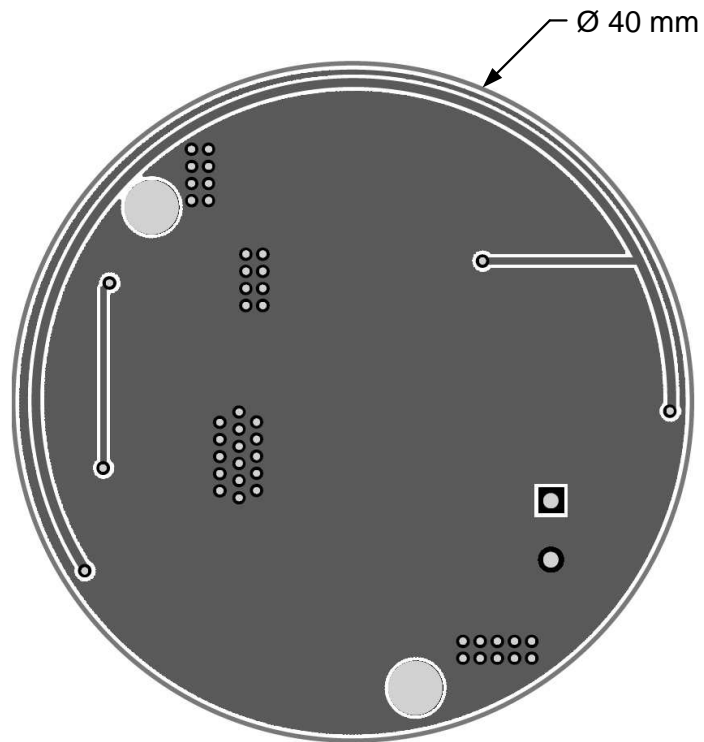

Figure 9. Bottom Layer

IMPORTANT NOTICE

Texas Instruments Incorporated and its subsidiaries (TI) reserve the right to make corrections, enhancements, improvements and other changes to its semiconductor products and services per JESD46, latest issue, and to discontinue any product or service per JESD48, latest issue. Buyers should obtain the latest relevant information before placing orders and should verify that such information is current and complete. All semiconductor products (also referred to herein as "components") are sold subject to TI's terms and conditions of sale supplied at the time of order acknowledgment.

TI warrants performance of its components to the specifications applicable at the time of sale, in accordance with the warranty in TI's terms and conditions of sale of semiconductor products. Testing and other quality control techniques are used to the extent TI deems necessary to support this warranty. Except where mandated by applicable law, testing of all parameters of each component is not necessarily performed.

TI assumes no liability for applications assistance or the design of Buyers' products. Buyers are responsible for their products and applications using TI components. To minimize the risks associated with Buyers' products and applications, Buyers should provide adequate design and operating safeguards.

TI does not warrant or represent that any license, either express or implied, is granted under any patent right, copyright, mask work right, or other intellectual property right relating to any combination, machine, or process in which TI components or services are used. Information published by TI regarding third-party products or services does not constitute a license to use such products or services or a warranty or endorsement thereof. Use of such information may require a license from a third party under the patents or other intellectual property of the third party, or a license from TI under the patents or other intellectual property of TI.

Reproduction of significant portions of TI information in TI data books or data sheets is permissible only if reproduction is without alteration and is accompanied by all associated warranties, conditions, limitations, and notices. TI is not responsible or liable for such altered documentation. Information of third parties may be subject to additional restrictions.

Resale of TI components or services with statements different from or beyond the parameters stated by TI for that component or service voids all express and any implied warranties for the associated TI component or service and is an unfair and deceptive business practice. TI is not responsible or liable for any such statements.

Buyer acknowledges and agrees that it is solely responsible for compliance with all legal, regulatory and safety-related requirements concerning its products, and any use of TI components in its applications, notwithstanding any applications-related information or support that may be provided by TI. Buyer represents and agrees that it has all the necessary expertise to create and implement safeguards which anticipate dangerous consequences of failures, monitor failures and their consequences, lessen the likelihood of failures that might cause harm and take appropriate remedial actions. Buyer will fully indemnify TI and its representatives against any damages arising out of the use of any TI components in safety-critical applications.

In some cases, TI components may be promoted specifically to facilitate safety-related applications. With such components, TI's goal is to help enable customers to design and create their own end-product solutions that meet applicable functional safety standards and requirements. Nonetheless, such components are subject to these terms.

No TI components are authorized for use in FDA Class III (or similar life-critical medical equipment) unless authorized officers of the parties have executed a special agreement specifically governing such use.

Only those TI components which TI has specifically designated as military grade or "enhanced plastic" are designed and intended for use in military/aerospace applications or environments. Buyer acknowledges and agrees that any military or aerospace use of TI components which have **not** been so designated is solely at the Buyer's risk, and that Buyer is solely responsible for compliance with all legal and regulatory requirements in connection with such use.

TI has specifically designated certain components as meeting ISO/TS16949 requirements, mainly for automotive use. In any case of use of non-designated products, TI will not be responsible for any failure to meet ISO/TS16949.

Products

Audio	www.ti.com/audio
Amplifiers	amplifier.ti.com
Data Converters	dataconverter.ti.com
DLP® Products	www.dlp.com
DSP	dsp.ti.com
Clocks and Timers	www.ti.com/clocks
Interface	interface.ti.com
Logic	logic.ti.com
Power Mgmt	power.ti.com
Microcontrollers	microcontroller.ti.com
RFID	www.ti-rfid.com
OMAP Applications Processors	www.ti.com/omap
Wireless Connectivity	www.ti.com/wirelessconnectivity

Applications

Automotive and Transportation	www.ti.com/automotive
Communications and Telecom	www.ti.com/communications
Computers and Peripherals	www.ti.com/computers
Consumer Electronics	www.ti.com/consumer-apps
Energy and Lighting	www.ti.com/energy
Industrial	www.ti.com/industrial
Medical	www.ti.com/medical
Security	www.ti.com/security
Space, Avionics and Defense	www.ti.com/space-avionics-defense
Video and Imaging	www.ti.com/video

TI E2E Community

e2e.ti.com