

Description

This dual rectifier is based on a proprietary technology that achieves the best in class V_F/I_R for a given silicon surface.

Packaged in TO-220AB, and D²PAK, this device is intended to be used in switch mode power supplies, or automotive applications

Table 1. Device summary

$I_{F(AV)}$	2 x 20 A
V_{RRM}	45 V
$V_F(\text{typ})$	0.34 V

Features

- ST advanced rectifier process
- Stable leakage current over reverse voltage
- Low forward voltage drop
- High frequency operation

1 Characteristics

Table 2. Absolute ratings (limiting values, per diode at 25° C, unless otherwise stated)

Symbol	Parameter			Value	Unit
V_{RRM}	Repetitive peak reverse voltage			45	V
$I_{F(RMS)}$	Forward rms current			40	A
$I_{F(AV)}$	Average forward current, $\delta = 0.5$	$T_c = 150^\circ\text{C}$	Per diode	20	A
		$T_c = 140^\circ\text{C}$	Per device	40	
I_{FSM}	Surge non repetitive forward current		$t_p = 10\text{ ms sinusoidal}$	275	A
T_{stg}	Storage temperature range			-65 to + 175	°C
T_j	Maximum operating junction temperature ⁽¹⁾	TO-220AB, D ² PAK		175	°C
		D ² PAK (DC forward current without reverse bias, t = 1 hour)		200	

1. $\frac{dP_{tot}}{dT_j} < \frac{1}{R_{th(j-a)}}$ condition to avoid thermal runaway for a diode on its own heatsink

Table 3. Thermal resistances

Symbol	Parameter		Value	Unit
$R_{th(j-c)}$	Junction to case	Per diode	1.6	°C/W
		Total	1.1	
$R_{th(c)}$	Coupling		0.5	°C/W

When the diodes 1 and 2 are used simultaneously:

$$\Delta T_j(\text{diode 1}) = P(\text{diode1}) \times R_{th(j-c)}(\text{Per diode}) + P(\text{diode2}) \times R_{th(c)}$$

Table 4. Static electrical characteristics (per diode)

Symbol	Parameter	Test Conditions		Min.	Typ.	Max.	Unit
$I_R^{(1)}$	Reverse leakage current	$T_j = 25^\circ\text{C}$	$V_R = V_{RRM}$			650	μA
		$T_j = 125^\circ\text{C}$			25	50	mA
$V_F^{(2)}$	Forward voltage drop	$T_j = 25^\circ\text{C}$	$I_F = 10\text{ A}$		0.38	0.415	V
		$T_j = 125^\circ\text{C}$			0.34	0.37	
		$T_j = 25^\circ\text{C}$	$I_F = 20\text{ A}$		0.46	0.50	
		$T_j = 125^\circ\text{C}$			0.46	0.50	

1. Pulse test: $t_p = 5\text{ ms}$, $\delta < 2\%$

2. Pulse test: $t_p = 380\text{ μs}$, $\delta < 2\%$

To evaluate the conduction losses use the following equation:

$$P = 0.31 \times I_{F(AV)} + 0.0095 I_{F(RMS)}^2$$

Figure 1. Average forward power dissipation versus average forward current (per diode)

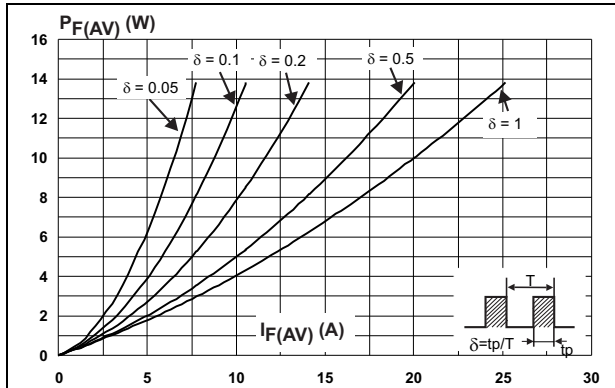

Figure 2. Average forward current versus ambient temperature ($\delta = 0.5$, per diode)

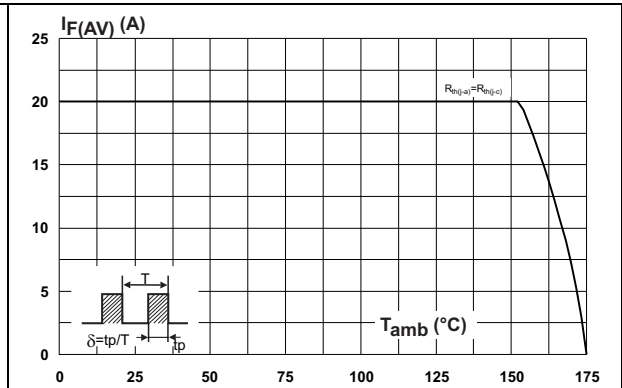

Figure 3. Relative variation of thermal impedance junction to case versus pulse duration

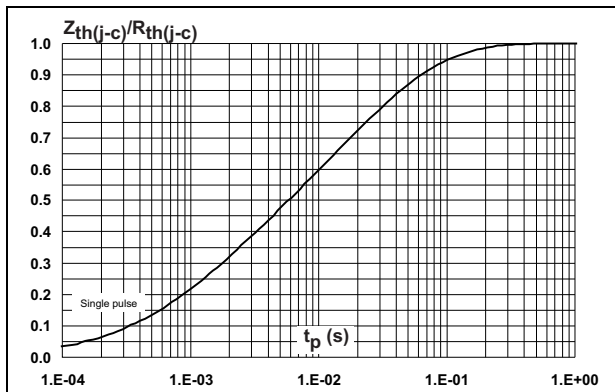

Figure 4. Reverse leakage current versus reverse voltage applied (typical values, per diode)

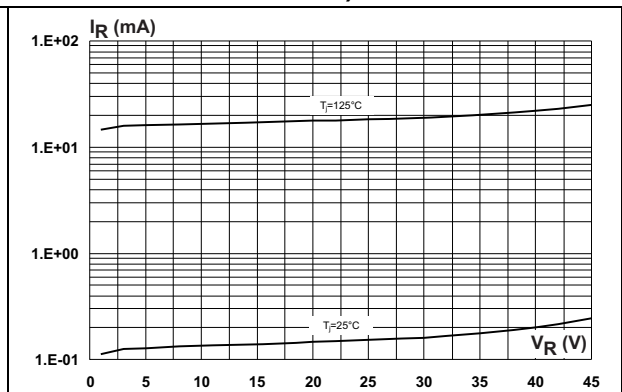

Figure 5. Junction capacitance versus reverse voltage applied (typical values, per diode)

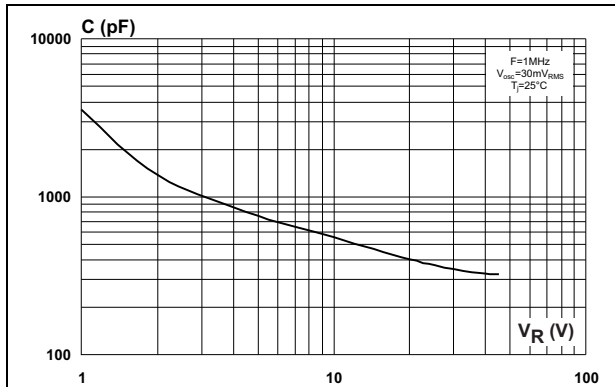

Figure 6. Forward voltage drop versus forward current (typical values, per diode)

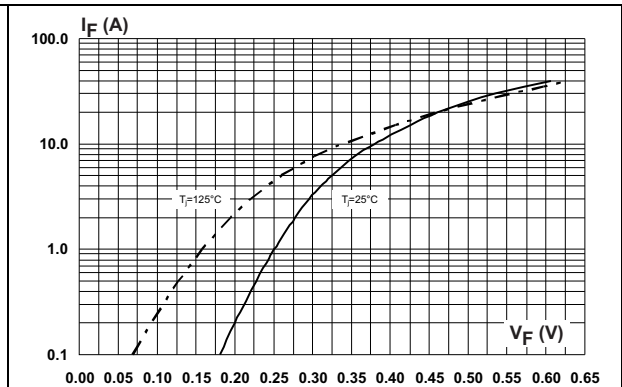
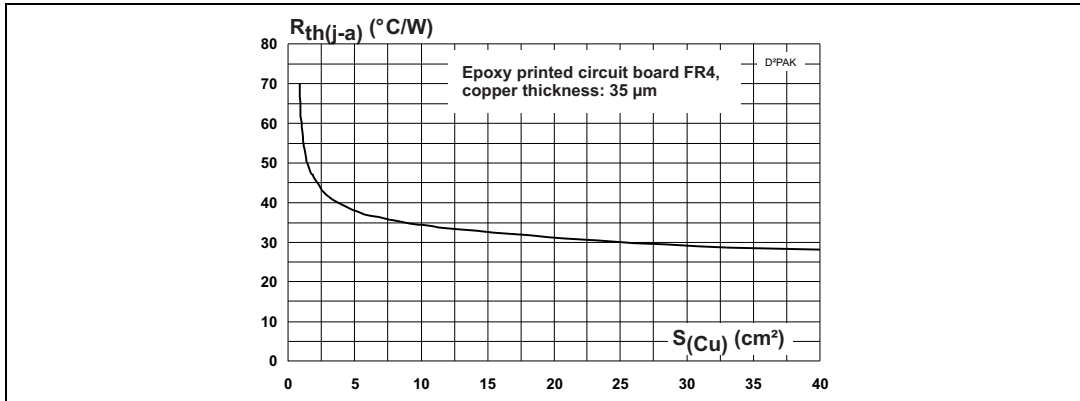

Figure 7. Thermal resistance junction to ambient versus copper surface under tab (typical values)



2 Package Information

- Epoxy meets UL94,V0
- Cooling method: by conduction (C)
- Recommended torque value: 0.4 to 0.6 N·m (TO-220AB)

In order to meet environmental requirements, ST offers these devices in different grades of ECOPACK® packages, depending on their level of environmental compliance. ECOPACK® specifications, grade definitions and product status are available at: www.st.com. ECOPACK® is an ST trademark.

Figure 8. TO-220AB dimension definitions

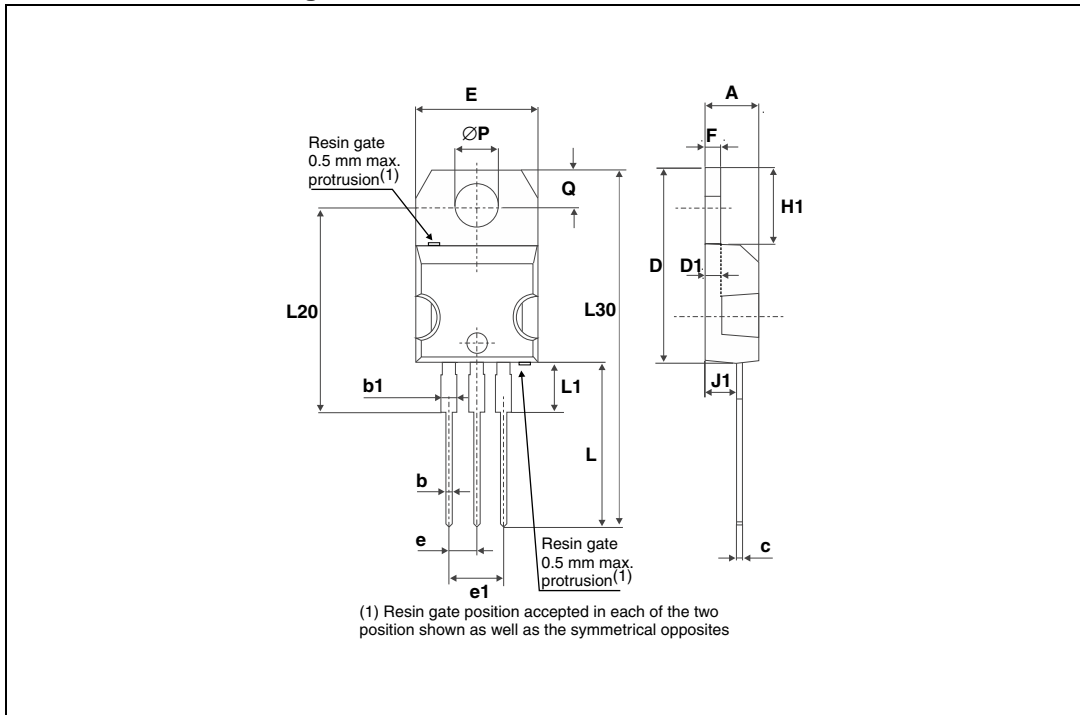

Table 5. TO-220AB dimension values

Ref.	Dimensions			
	Millimeters		Inches	
	Min.	Max.	Min.	Max.
A	4.40	4.60	0.17	0.18
b	0.61	0.88	0.024	0.035
b1	1.14	1.70	0.045	0.067
c	0.48	0.70	0.019	0.027
D	15.25	15.75	0.60	0.62
D1	1.27 typ.		0.05 typ.	
E	10	10.40	0.39	0.41
e	2.40	2.70	0.094	0.106
e1	4.95	5.15	0.19	0.20
F	1.23	1.32	0.048	0.052
H1	6.20	6.60	0.24	0.26
J1	2.40	2.72	0.094	0.107
L	13	14	0.51	0.55
L1	3.50	3.93	0.137	0.154
L20	16.40 typ.		0.64 typ.	
L30	28.90 typ.		1.13 typ.	
ØP	3.75	3.85	0.147	0.151
Q	2.65	2.95	0.104	0.116

Figure 9. D²PAK dimension definitions

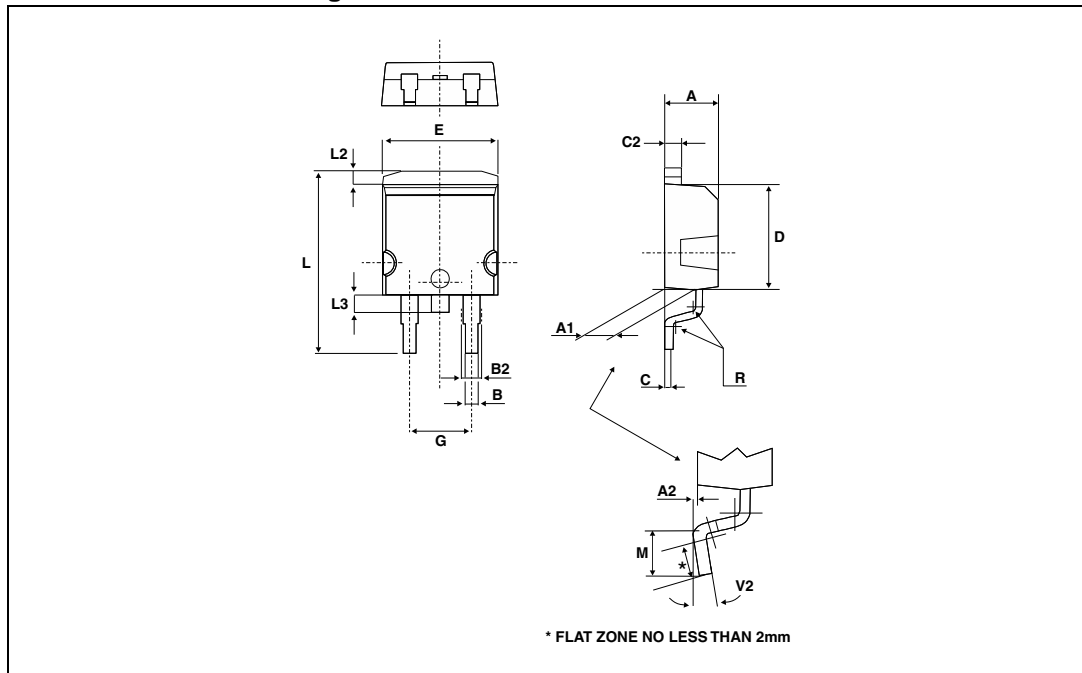
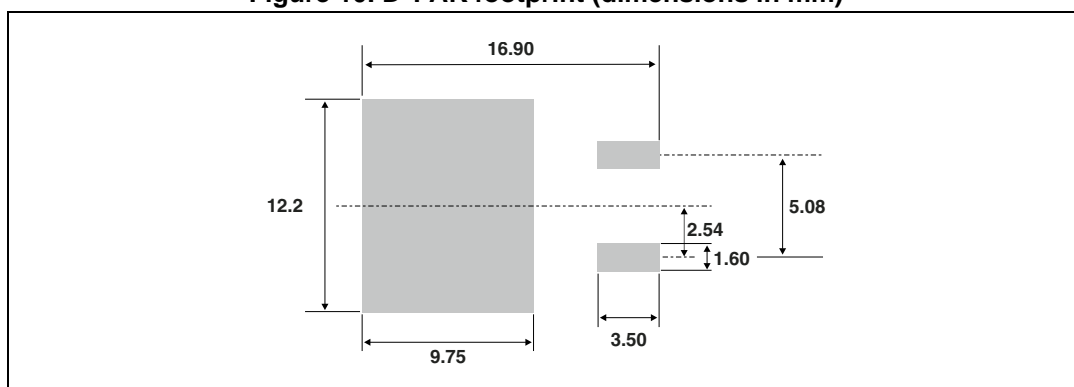

Table 6. D²PAK dimension values

Ref.	Dimensions			
	Millimeters		Inches	
	Min.	Max.	Min.	Max.
A	4.40	4.60	0.173	0.181
A1	2.49	2.69	0.098	0.106
A2	0.03	0.23	0.001	0.009
B	0.70	0.93	0.027	0.037
B2	1.14	1.70	0.045	0.067
C	0.45	0.60	0.017	0.024
C2	1.23	1.36	0.048	0.054
D	8.95	9.35	0.352	0.368
E	10.00	10.40	0.393	0.409
G	4.88	5.28	0.192	0.208
L	15.00	15.85	0.590	0.624
L2	1.27	1.40	0.050	0.055
L3	1.30	1.75	0.051	0.069
M	2.29	2.79	0.090	0.110
R	0.40 typ.		0.016 typ.	
V2	0°	8°	0°	8°

Figure 10. D²PAK footprint (dimensions in mm)



3 Ordering Information

Table 7. Ordering information

Order code	Marking	Package	Weight	Base qty	Delivery mode
FERD40M45CT	FERD40M45CT	TO-220AB	2.2 g	50	Tube
FERD40M45CG-TR	FERD40M45CG	D ² PAK	1.8 g	500	Tape and reel

4 Revision history

Table 8. Document revision history

Date	Revision	Description of Changes
13-Nov-2013	1	Initial release

Please Read Carefully:

Information in this document is provided solely in connection with ST products. STMicroelectronics NV and its subsidiaries ("ST") reserve the right to make changes, corrections, modifications or improvements, to this document, and the products and services described herein at any time, without notice.

All ST products are sold pursuant to ST's terms and conditions of sale.

Purchasers are solely responsible for the choice, selection and use of the ST products and services described herein, and ST assumes no liability whatsoever relating to the choice, selection or use of the ST products and services described herein.

No license, express or implied, by estoppel or otherwise, to any intellectual property rights is granted under this document. If any part of this document refers to any third party products or services it shall not be deemed a license grant by ST for the use of such third party products or services, or any intellectual property contained therein or considered as a warranty covering the use in any manner whatsoever of such third party products or services or any intellectual property contained therein.

UNLESS OTHERWISE SET FORTH IN ST'S TERMS AND CONDITIONS OF SALE ST DISCLAIMS ANY EXPRESS OR IMPLIED WARRANTY WITH RESPECT TO THE USE AND/OR SALE OF ST PRODUCTS INCLUDING WITHOUT LIMITATION IMPLIED WARRANTIES OF MERCHANTABILITY, FITNESS FOR A PARTICULAR PURPOSE (AND THEIR EQUIVALENTS UNDER THE LAWS OF ANY JURISDICTION), OR INFRINGEMENT OF ANY PATENT, COPYRIGHT OR OTHER INTELLECTUAL PROPERTY RIGHT.

ST PRODUCTS ARE NOT DESIGNED OR AUTHORIZED FOR USE IN: (A) SAFETY CRITICAL APPLICATIONS SUCH AS LIFE SUPPORTING, ACTIVE IMPLANTED DEVICES OR SYSTEMS WITH PRODUCT FUNCTIONAL SAFETY REQUIREMENTS; (B) AERONAUTIC APPLICATIONS; (C) AUTOMOTIVE APPLICATIONS OR ENVIRONMENTS, AND/OR (D) AEROSPACE APPLICATIONS OR ENVIRONMENTS. WHERE ST PRODUCTS ARE NOT DESIGNED FOR SUCH USE, THE PURCHASER SHALL USE PRODUCTS AT PURCHASER'S SOLE RISK, EVEN IF ST HAS BEEN INFORMED IN WRITING OF SUCH USAGE, UNLESS A PRODUCT IS EXPRESSLY DESIGNATED BY ST AS BEING INTENDED FOR "AUTOMOTIVE, AUTOMOTIVE SAFETY OR MEDICAL" INDUSTRY DOMAINS ACCORDING TO ST PRODUCT DESIGN SPECIFICATIONS. PRODUCTS FORMALLY ESCC, QML OR JAN QUALIFIED ARE DEEMED SUITABLE FOR USE IN AEROSPACE BY THE CORRESPONDING GOVERNMENTAL AGENCY.

Resale of ST products with provisions different from the statements and/or technical features set forth in this document shall immediately void any warranty granted by ST for the ST product or service described herein and shall not create or extend in any manner whatsoever, any liability of ST.

ST and the ST logo are trademarks or registered trademarks of ST in various countries.

Information in this document supersedes and replaces all information previously supplied.

The ST logo is a registered trademark of STMicroelectronics. All other names are the property of their respective owners.

© 2013 STMicroelectronics - All rights reserved

STMicroelectronics group of companies

Australia - Belgium - Brazil - Canada - China - Czech Republic - Finland - France - Germany - Hong Kong - India - Israel - Italy - Japan - Malaysia - Malta - Morocco - Philippines - Singapore - Spain - Sweden - Switzerland - United Kingdom - United States of America

www.st.com

Mouser Electronics

Authorized Distributor

Click to View Pricing, Inventory, Delivery & Lifecycle Information:

[STMicroelectronics:](#)

[FERD40M45CG-TR](#) [FERD40M45CT](#)