

CGA4C4NP02W471J060AA

TDK Item Description : CGA4C4NP02W471T***



Equivalent C2012NP02W471J for Automotive

Application & Main Feature

Automotive Grade (High Temperature Application)

Series

CGA4(2012) [EIA CC0805]

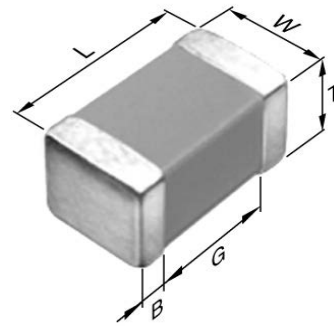

Dimensions

L	2.00mm +/-0.2mm
W	1.25mm +/-0.2mm
T	0.60 +/-0.15mm
B	0.2mm Min.
G	0.5mm Min.

Temperature Characteristic

NP0 (-55 to 150 degC 0+/-30ppm/degC)

Rated Voltage

2W (450Vdc)

Capacitance

470pF

Capacitance Tolerance

J (+/-5%)

Q Factor

1000 Min.

Insulation Resistance

10Gohm Min

AEC-Q200

Yes

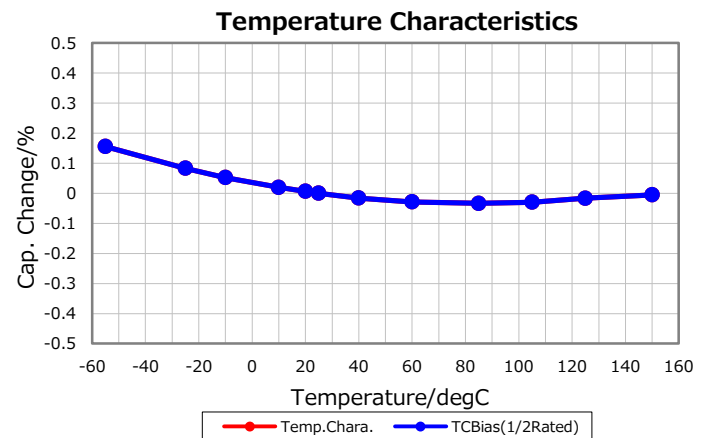
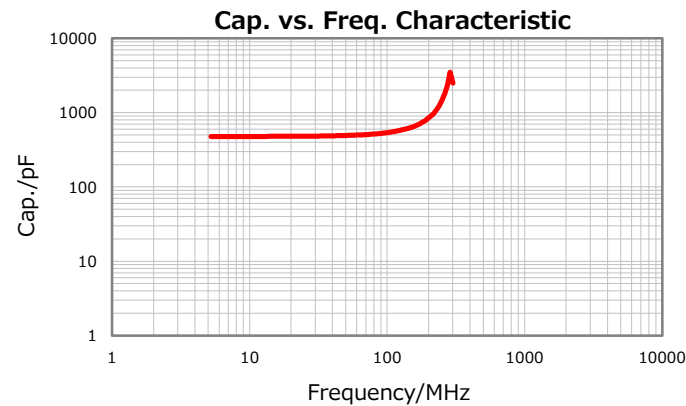
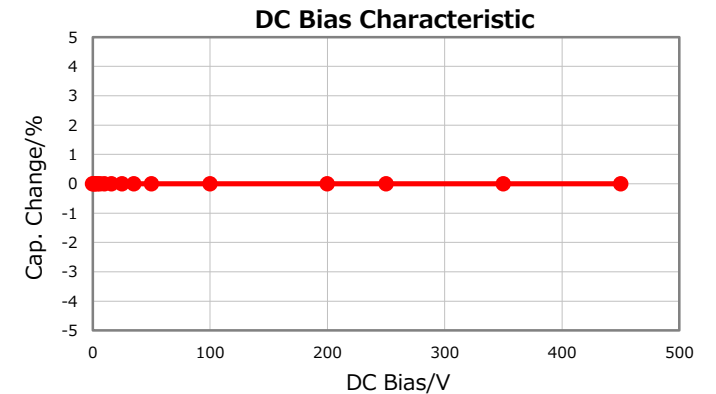
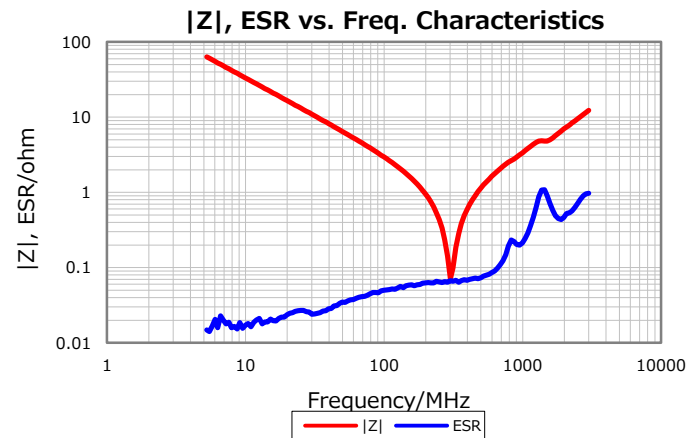

Characterization Sheet (Multilayer Ceramic Chip Capacitors)



All specifications are subject to change without notice.

April 13, 2016