



SinglFuse™ SF-0402S Series Features

- Slow blow thin film chip fuse for overcurrent protection
- 1005 (EIA 0402) miniature footprint
- Surface mount packaging for automated assembly
- UL listed (UL 248-14)
- RoHS compliant* and halogen free**

SF-0402S Series - Slow Blow Surface Mount Fuses

Electrical Characteristics

Model	Rated Current (Amps)	Fusing Time	Resistance (mΩ) Typ.***	Rated Voltage	Breaking Capacity	Typical I ² t (A ² s) ****
SF-0402S050	0.50	Open within 5 sec. at 250 % rated current	300	DC 32 V	DC 32 V 35 A	0.00370
SF-0402S080	0.80		78			0.00947
SF-0402S100	1.00		75			0.01479
SF-0402S125	1.25		44			0.02310
SF-0402S150	1.50		34.5			0.02400
SF-0402S160	1.60		29.5			0.03734
SF-0402S200	2.00		23			0.04040
SF-0402S250	2.50		18			0.06760
SF-0402S300	3.00		15			0.09860
SF-0402S315	3.15		14			0.10868
SF-0402S400	4.00		10			0.11450

*** Resistance value was measured with less than 10 % of rated current. Tolerance ±25 %.

****Typical I²t value is measured at 10x rated current.

Reliability Testing

No.	Test	Requirement	Test Condition
1	Carrying Capacity	No fusing	Rated current, 4 hours
2	Fusing Time	Within 5 seconds	250 % of its rated current
3	Interrupting Ability	No mechanical damages	After the fuse is interrupted, rated voltage applied for 30 seconds again
4	Bending Test	No mechanical damages	Distance between holding points: 90 mm, Bending: 3 mm, 1 time, 30 seconds
5	Resistance to Solder Heat	±20 %	260 °C ±5 °C, 10 seconds ±1 second
6	Solderability	95 % coverage minimum	235 °C ±5 °C, 2 ±0.5 second 245 °C ±5 °C, 2 ±0.5 second (lead free)
7	Temperature Rise	<75 °C	100 % of its rated current, measure of surface temperature
8	Resistance to Dry Heat	±20 %	105 °C ±5 °C, 1000 hours
9	Resistance to Solvent	No evident damage on protective coating and marking	23 °C ±5 °C of isopropyl alcohol, 90 seconds
10	Residual Resistance	10k ohms or more	Measure DC resistance after fusing
11	Thermal Shock	ΔR < 10 %	-20 °C / +25 °C / +125 °C / +25 °C, 10 cycles

Agency Recognition

UL File Number E198545

Environmental Characteristics

Operating Temperature.....-20 °C to +105 °C
 Storage Conditions
 Temperature+5 °C to +35 °C
 Humidity.....40 % to 75 %
 Shelf Life..... 2 years from manufacturing date
 Moisture Sensitivity Level 1
 ESD Classification (HBM)..... Class 6



WARNING Cancer and Reproductive Harm
www.P65Warnings.ca.gov

* RoHS Directive 2002/95/EC Jan. 27, 2003 including annex and RoHS Recast 2011/65/EU June 8, 2011.

** Bourns considers a product to be "halogen free" if (a) the Bromine (Br) content is 900 ppm or less; (b) the Chlorine (Cl) content is 900 ppm or less; and (c) the total Bromine (Br) and Chlorine (Cl) content is 1500 ppm or less.

"SinglFuse" is a trademark of Bourns, Inc.

Specifications are subject to change without notice.

Users should verify actual device performance in their specific applications.

The products described herein and this document are subject to specific legal disclaimers as set forth on the last page of this document, and at www.bourns.com/docs/legal/disclaimer.pdf.

SingIFuse™ SF-0402S Series Applications

- Portable memory
- LCD monitors
- Disk drives
- PDAs
- Digital cameras
- DVDs
- Cell phones
- Rechargeable battery packs
- Battery chargers
- Set top boxes
- Industrial controllers

SF-0402S Series - Slow Blow Surface Mount Fuses BOURNS®

Typical Part Marking

Represents total content. Layout may vary.



RATED CURRENT (A)

D = 0.315	N = 1.60
F = 0.50	S = 2.00
V = 0.75	T = 2.50
K = 0.80	3 = 3.00
L = 1.00	U = 3.15
M = 1.25	W = 4.00
P = 1.50	

How to Order

SF - 0402 S 050 - 2

SingIFuse™
 Product Designator
 SMD Footprint
 1005 (EIA 0402) size
 Fuse Blow Type
 S = Slow blow
 Rated Current
 050-400 (500 mA - 4.00 A)
 Packaging Type
 - 2 = Tape & Reel (10,000 pcs./reel)

Construction & Material Content

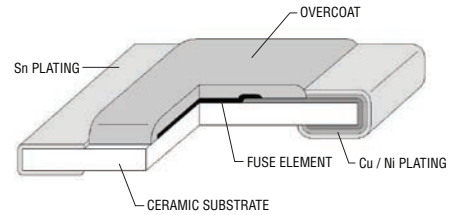

Packaging Quantity

10,000 pieces per 7-inch reel

Product Dimensions

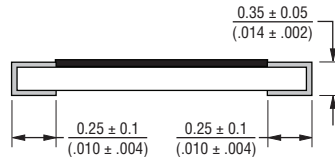
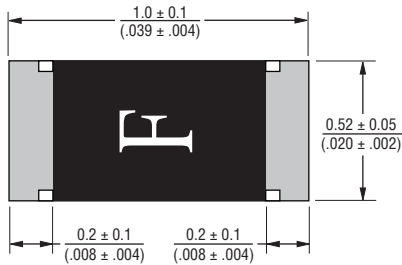

DIMENSIONS: $\frac{\text{MM}}{\text{(INCHES)}}$

Recommended Pad Layout

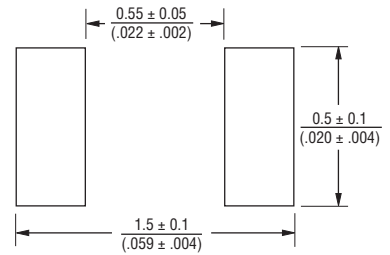

Thermal Derating Curve

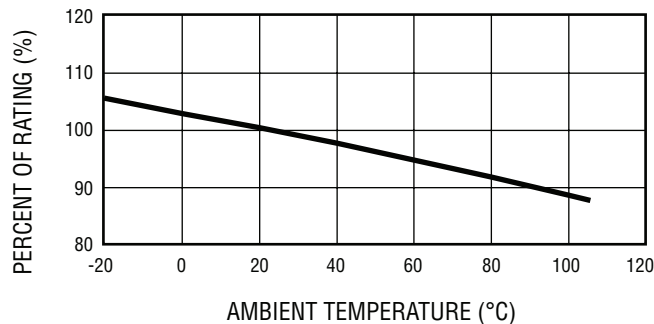

Specifications are subject to change without notice. Users should verify actual device performance in their specific applications. The products described herein and this document are subject to specific legal disclaimers as set forth on the last page of this document, and at www.bourns.com/docs/legal/disclaimer.pdf.

SF-0402S Series - Slow Blow Surface Mount Fuses

BOURNS®

Solder Reflow Recommendations

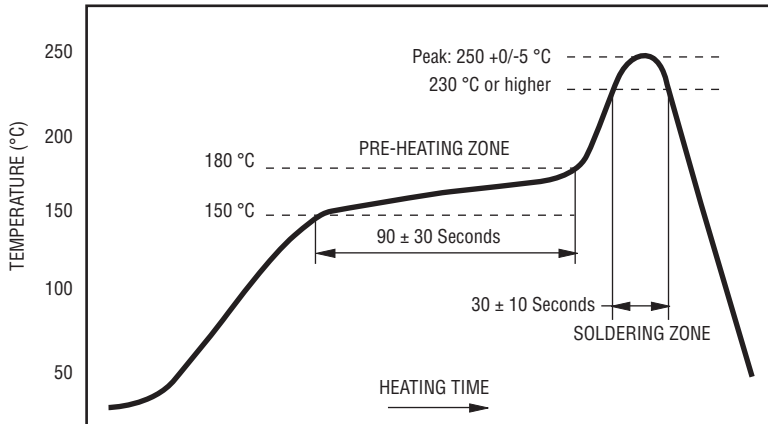

PEAK: 250 +0/-5 °C, 5 seconds
 PRE-HEATING ZONE: 150 to 180 °C, 90 ± 30 seconds
 SOLDERING ZONE: 230 °C or higher, 30 ± 10 seconds

Average Time Current Curves

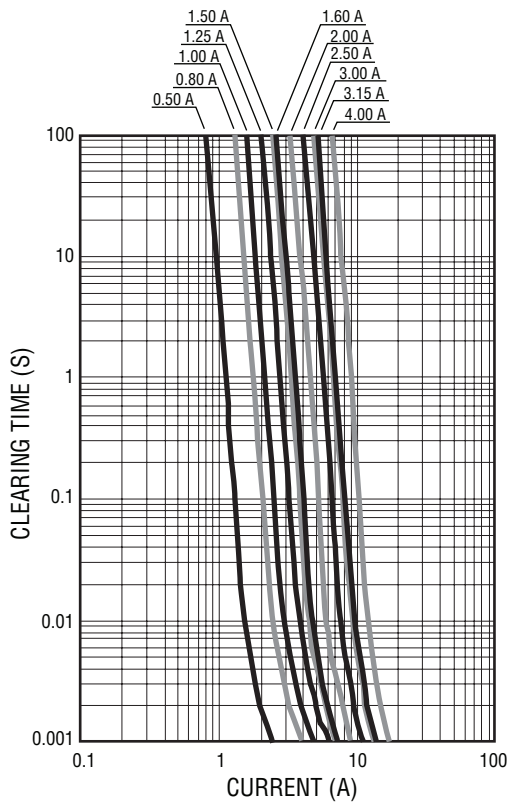

Minimum I²T V Clear Time Curves

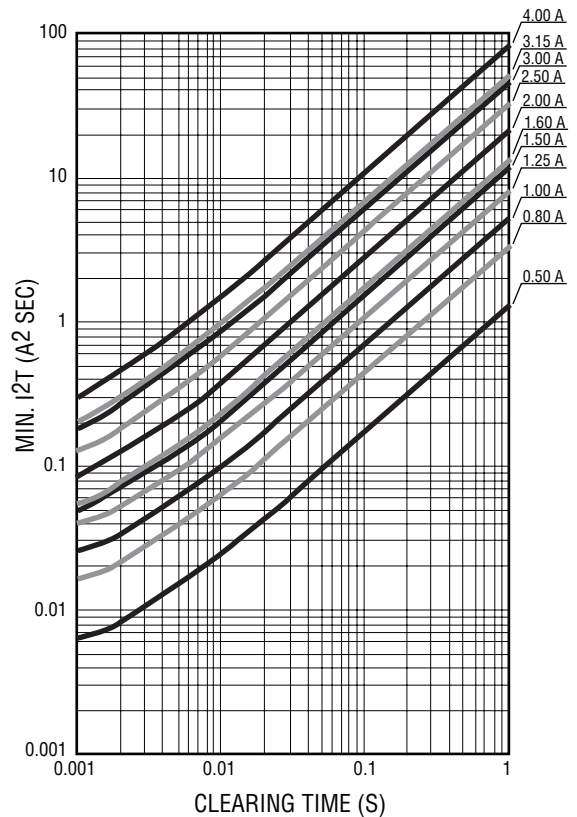

REV. I 01/19

Specifications are subject to change without notice.

Users should verify actual device performance in their specific applications.

The products described herein and this document are subject to specific legal disclaimers as set forth on the last page of this document, and at www.bourns.com/docs/legal/disclaimer.pdf.

SF-0402S Series Tape and Reel Specifications

BOURNS®

Tape Dimensions	SF-0402S Series per EIA 481-2
W	$\frac{8.0 \pm 0.2}{(.315 \pm .008)}$
P ₀	$\frac{4.0 \pm 0.1}{(.157 \pm .004)}$
P ₁	$\frac{2.0 \pm 0.1}{(.079 \pm .004)}$
P ₂	$\frac{2.0 \pm 0.05}{(.079 \pm .002)}$
A	$\frac{0.7 \pm 0.05}{(.028 \pm .002)}$
B	$\frac{1.2 \pm 0.05}{(.047 \pm .002)}$
F	$\frac{3.5 \pm 0.05}{(.138 \pm .002)}$
E	$\frac{1.75 \pm 0.1}{(.069 \pm .004)}$
D ₀	$\frac{1.5 \pm 0.1}{(.059 \pm .004)}$
T	$\frac{0.45 \pm 0.01}{(.018 \pm .004)}$
Reel Dimensions	
A	$\frac{180 \pm 0/-3.0}{(7.087 \pm 0/-118)}$
B Min.	$\frac{60.0}{(2.362)}$
C	$\frac{13.0 \pm 1.0}{(.512 \pm .039)}$
W	$\frac{9.0 \pm 1.0}{(.354 \pm .039)}$
T	$\frac{11.4 \pm 2.0}{(.449 \pm .079)}$

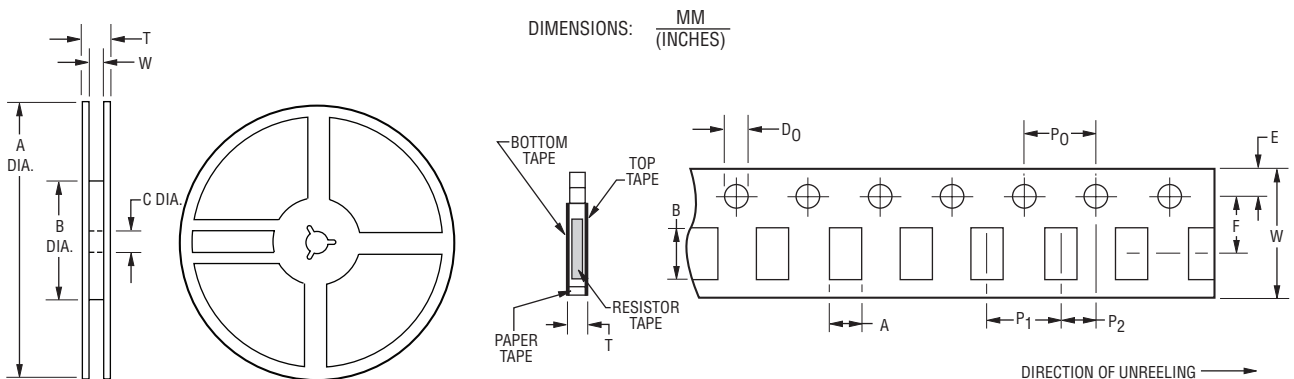

Specifications are subject to change without notice.
 Users should verify actual device performance in their specific applications.
 The products described herein and this document are subject to specific legal disclaimers as set forth on the last page of this document, and at www.bourns.com/docs/legal/disclaimer.pdf.

Legal Disclaimer Notice

BOURNS®

This legal disclaimer applies to purchasers and users of Bourns® products manufactured by or on behalf of Bourns, Inc. and its affiliates (collectively, "Bourns").

Unless otherwise expressly indicated in writing, Bourns® products and data sheets relating thereto are subject to change without notice. Users should check for and obtain the latest relevant information and verify that such information is current and complete before placing orders for Bourns® products.

The characteristics and parameters of a Bourns® product set forth in its data sheet are based on laboratory conditions, and statements regarding the suitability of products for certain types of applications are based on Bourns' knowledge of typical requirements in generic applications. The characteristics and parameters of a Bourns® product in a user application may vary from the data sheet characteristics and parameters due to (i) the combination of the Bourns® product with other components in the user's application, or (ii) the environment of the user application itself. The characteristics and parameters of a Bourns® product also can and do vary in different applications and actual performance may vary over time. Users should always verify the actual performance of the Bourns® product in their specific devices and applications, and make their own independent judgments regarding the amount of additional test margin to design into their device or application to compensate for differences between laboratory and real world conditions.

Unless Bourns has explicitly designated an individual Bourns® product as meeting the requirements of a particular industry standard (e.g., ISO/TS 16949) or a particular qualification (e.g., UL listed or recognized), Bourns is not responsible for any failure of an individual Bourns® product to meet the requirements of such industry standard or particular qualification. Users of Bourns® products are responsible for ensuring compliance with safety-related requirements and standards applicable to their devices or applications.

Bourns® products are not recommended, authorized or intended for use in nuclear, lifesaving, life-critical or life-sustaining applications, nor in any other applications where failure or malfunction may result in personal injury, death, or severe property or environmental damage. Unless expressly and specifically approved in writing by two authorized Bourns representatives on a case-by-case basis, use of any Bourns® products in such unauthorized applications might not be safe and thus is at the user's sole risk. Life-critical applications include devices identified by the U.S. Food and Drug Administration as Class III devices and generally equivalent classifications outside of the United States.

Bourns expressly identifies those Bourns® standard products that are suitable for use in automotive applications on such products' data sheets in the section entitled "Applications." Unless expressly and specifically approved in writing by two authorized Bourns representatives on a case-by-case basis, use of any other Bourns® standard products in an automotive application might not be safe and thus is not recommended, authorized or intended and is at the user's sole risk. If Bourns expressly identifies a sub-category of automotive application in the data sheet for its standard products (such as infotainment or lighting), such identification means that Bourns has reviewed its standard product and has determined that if such Bourns® standard product is considered for potential use in automotive applications, it should only be used in such sub-category of automotive applications. Any reference to Bourns® standard product in the data sheet as compliant with the AEC-Q standard or "automotive grade" does not by itself mean that Bourns has approved such product for use in an automotive application.

Bourns® standard products are not tested to comply with United States Federal Aviation Administration standards generally or any other generally equivalent governmental organization standard applicable to products designed or manufactured for use in aircraft or space applications. Bourns expressly identifies Bourns® standard products that are suitable for use in aircraft or space applications on such products' data sheets in the section entitled "Applications." Unless expressly and specifically approved in writing by two authorized Bourns representatives on a case-by-case basis, use of any other Bourns® standard product in an aircraft or space application might not be safe and thus is not recommended, authorized or intended and is at the user's sole risk.

The use and level of testing applicable to Bourns® custom products shall be negotiated on a case-by-case basis by Bourns and the user for which such Bourns® custom products are specially designed. Absent a written agreement between Bourns and the user regarding the use and level of such testing, the above provisions applicable to Bourns® standard products shall also apply to such Bourns® custom products.

Users shall not sell, transfer, export or re-export any Bourns® products or technology for use in activities which involve the design, development, production, use or stockpiling of nuclear, chemical or biological weapons or missiles, nor shall they use Bourns® products or technology in any facility which engages in activities relating to such devices. The foregoing restrictions apply to all uses and applications that violate national or international prohibitions, including embargos or international regulations. Further, Bourns® products and Bourns technology and technical data may not under any circumstance be exported or re-exported to countries subject to international sanctions or embargoes. Bourns® products may not, without prior authorization from Bourns and/or the U.S. Government, be resold, transferred, or re-exported to any party not eligible to receive U.S. commodities, software, and technical data.

To the maximum extent permitted by applicable law, Bourns disclaims (i) any and all liability for special, punitive, consequential, incidental or indirect damages or lost revenues or lost profits, and (ii) any and all implied warranties, including implied warranties of fitness for particular purpose, non-infringement and merchantability.

For your convenience, copies of this Legal Disclaimer Notice with German, Spanish, Japanese, Traditional Chinese and Simplified Chinese bilingual versions are available at:

Web Page: <http://www.bourns.com/legal/disclaimers-terms-and-policies>

PDF: <http://www.bourns.com/docs/Legal/disclaimer.pdf>

C1753 05/17/18R