

# SMD SHIELDED POWER INDUCTOR



18.5 x 15.2 x 7.6 mm

ASPI-1306S



**RoHS**  
Compliant

## FEATURES:

- Low radiation shielded architecture
- Large pads for good PCB mounting
- Low DCR, suitable for large currents
- High Energy storage

## APPLICATIONS:

- Portable communication equipment
- OA equipment
- LCD, DVD, modem, set-top box
- DC/DC converter

## ELECTRICAL SPECIFICATIONS:

Abracon P/N:	ASPI-1306S
Operating Temperature:	-40°C to +125°C (including self-generated heat)
Storage Temperature:	-40°C to +125°C

PART NUMBER	INDUCTANCE ( $\mu\text{H}$ ) $\pm 20\%$	DCR( $\Omega$ ) max	Isat (A) max	Irms (A) max	Q	SRF (MHz) Ref.
ASPI-1306S-100M	10	0.040	8.00	3.90	30.0	8.0
ASPI-1306S-150M	15	0.048	7.00	3.40	20.0	7.0
ASPI-1306S-220M	22	0.059	6.00	3.10	18.0	6.0
ASPI-1306S-330M	33	0.075	5.00	2.80	14.0	5.0
ASPI-1306S-470M	47	0.097	4.00	2.40	10.0	4.0
ASPI-1306S-680M	68	0.138	3.00	2.00	9.0	3.0
ASPI-1306S-101M	100	0.207	2.40	1.70	7.0	2.4
ASPI-1306S-151M	150	0.293	2.10	1.30	6.0	2.1
ASPI-1306S-221M	220	0.470	1.90	1.10	5.0	1.9
ASPI-1306S-331M	330	0.780	1.10	0.86	4.0	1.1
ASPI-1306S-471M	470	1.08	0.90	0.73	3.0	1.1
ASPI-1306S-681M	680	1.40	0.96	0.64	2.5	0.96
ASPI-1306S-102M	1000	2.01	0.80	0.53	2.0	0.80

### Test Conditions

**Inductance:** 200kHz, 0.1V (10  $\mu\text{H}$  – 15  $\mu\text{H}$ )

Inductance: 100kHz, 0.1V (22  $\mu\text{H}$  – 1000  $\mu\text{H}$ )

**Isat:**  $\Delta L/L$  (initial)  $\geq -10\%$

**Irms:**  $\Delta T \leq 40^\circ\text{C}$

## OPTIONS AND PART IDENTIFICATION

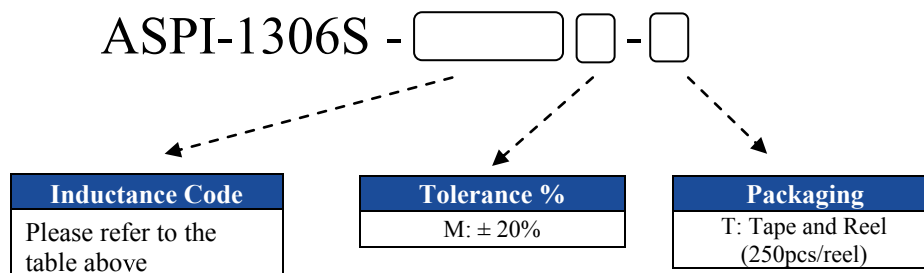

# SMD SHIELDED POWER INDUCTOR



18.5 x 15.2 x 7.6 mm

ASPI-1306S



RoHS  
Compliant

## MECHANICAL DIMENSIONS

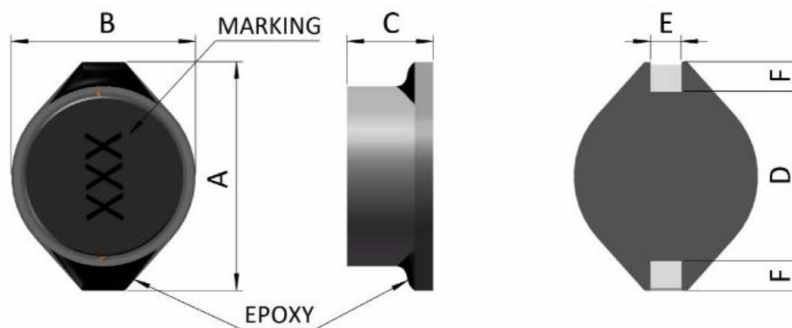

Part	A (max)	B (max)	C (max)	D	E	F
ASPI-1306S	18.54 ±0.15	15.24 ±0.15	7.62 ±0.15	12.7 ±0.15	2.54 ±0.15	2.54 ±0.15

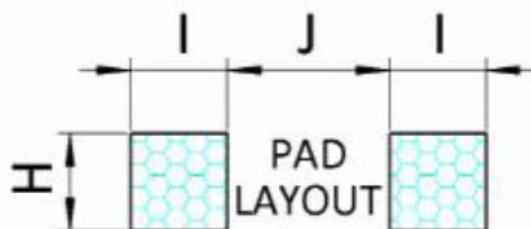

Part	H	I	J
ASPI-1306S	2.79 ±0.15	2.92 ±0.15	12.45 ±0.15

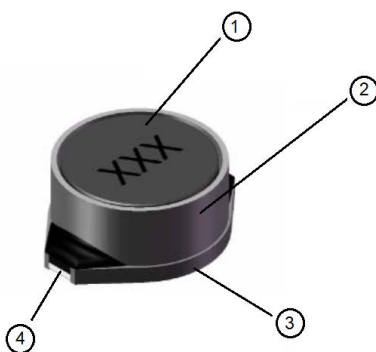

### Materials

No	Part Name	Material
1	Core	Fe <sub>2</sub> O <sub>3</sub>
		Mn <sub>3</sub> O <sub>4</sub>
		ZnO
		TMH 219 epoxy insulating powder (Black)
2	Wire	Copper Polyurethane Resin
3	Base	Aromatic polyester resin Class fiber
4	SN	CU
		Sn
		Ni

Dimension: mm

# SMD SHIELDED POWER INDUCTOR



18.5 x 15.2 x 7.6 mm

ASPI-1306S



RoHS  
Compliant

## ELECTRICAL SPECIFICATION CHART

**Packing**  
T: 250pcs / reel

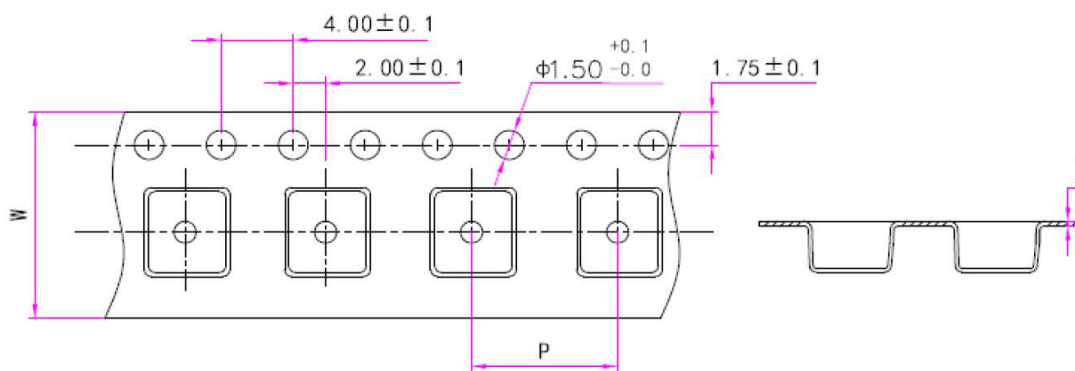
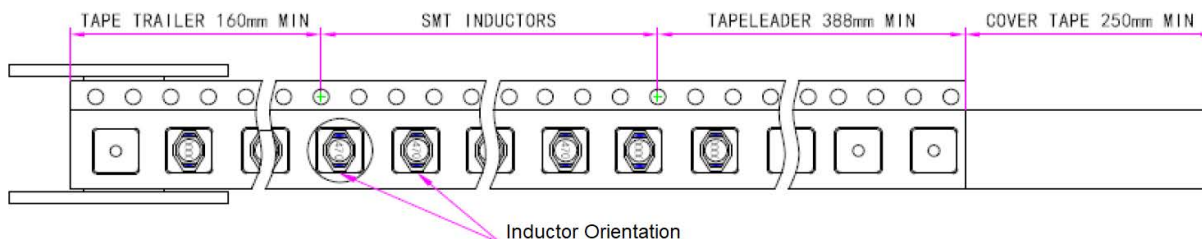

W	P	T
32 ± 0.3	20 ± 0.1	0.35 ± 0.05

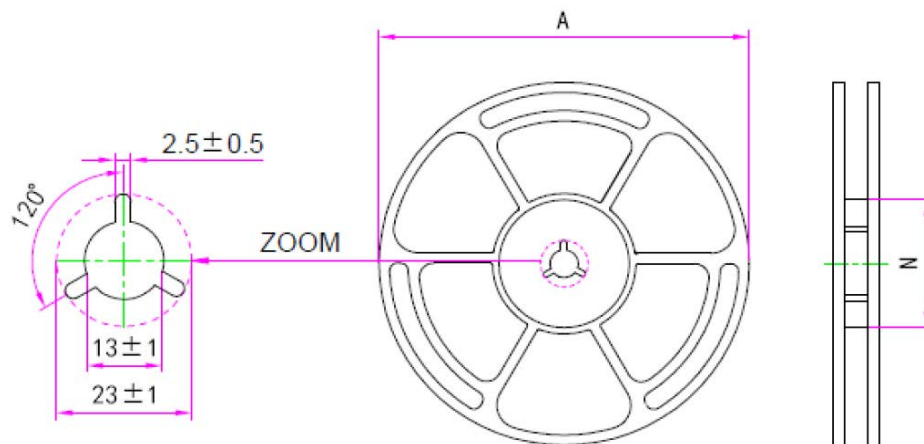

A	N
330	100

Dimension: mm

# SMD SHIELDED POWER INDUCTOR



18.5 x 15.2 x 7.6 mm

ASPI-1306S



## REFLOW PROFILE:

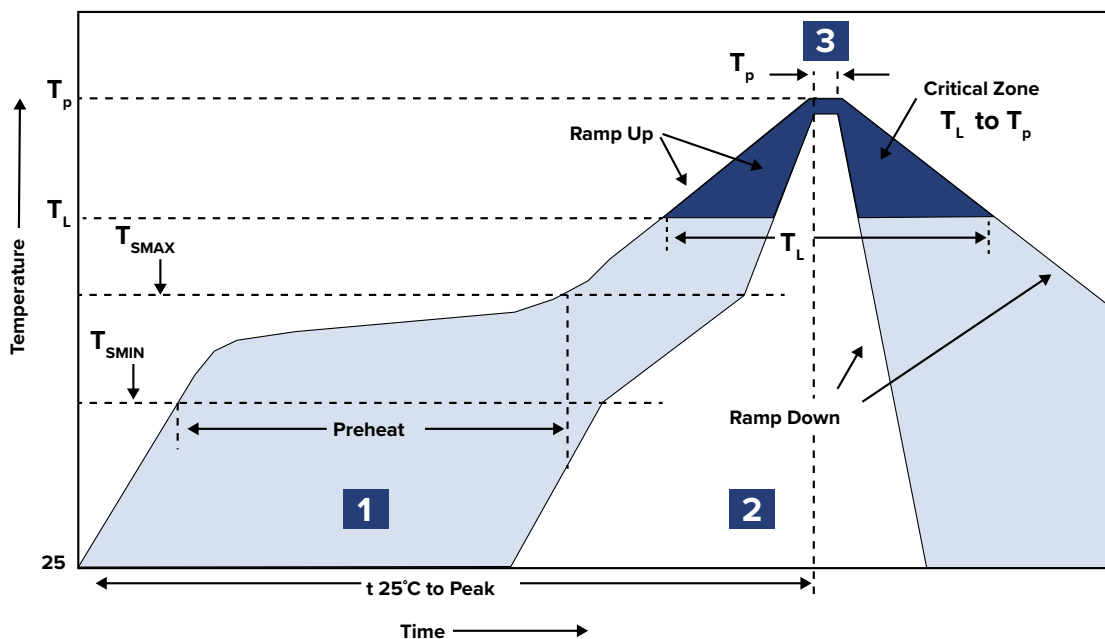

Zone	Description	Temperature	Time
1	Preheat / Soak	$T_{SMAX}$ 150°C ~ 180°C	60 ~ 120 sec.
2	Reflow	$T_L$ 230°C	40 sec.
3	Peak heat	$T_P$ 250°C ±5°C	10 sec. MAX

**ATTENTION:** Abracon LLC's products are COTS – Commercial-Off-The-Shelf products; suitable for Commercial, Industrial and, where designated, Automotive Applications. Abracon's products are not specifically designed for Military, Aviation, Aerospace, Life-dependent Medical applications or any application requiring high reliability where component failure could result in loss of life and/or property. For applications requiring high reliability and/or presenting an extreme operating environment, written consent and authorization from Abracon LLC is required. Please contact Abracon LLC for more information.