

This drawing is copyright. Information contained thereon is supplied in confidence and must not be used for any other purpose than which it was supplied, or be reproduced without written permission of the owners.

Diese Zeichnung ist unser geistiges Eigentum und darf ohne unsere ausdrückliche Einwilligung weder kopiert, vervielfältigt, noch Dritten oder Konkurrenzfirmen zugänglich gemacht werden.

type : 11 BNC-75-2-1

	date	sign
drawn	22.07.99	4726/Bom
checked	23.7.99	495
approved	23.7.99	495

cable shortening dimension

scale 2 : 1

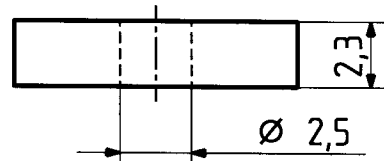
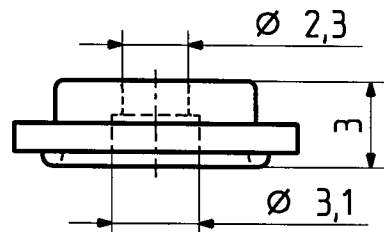
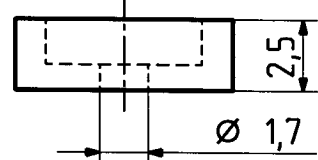
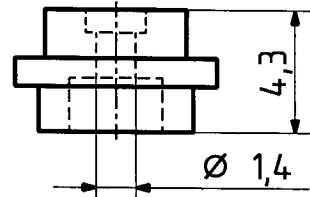
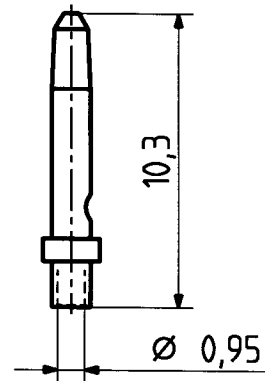
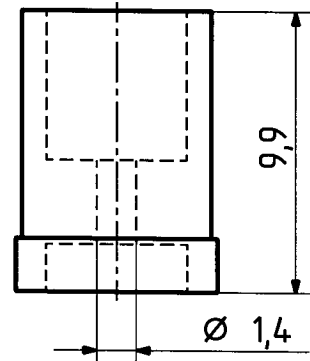
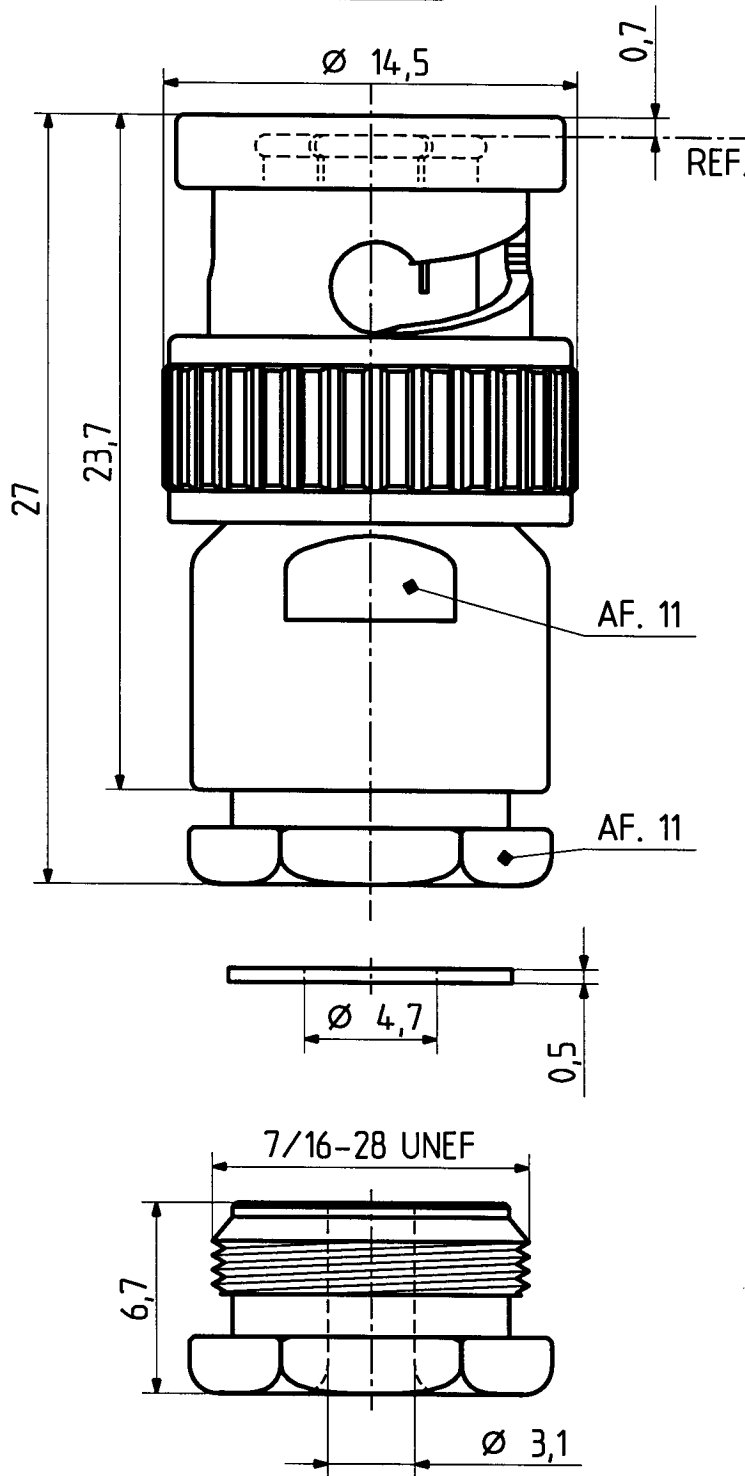
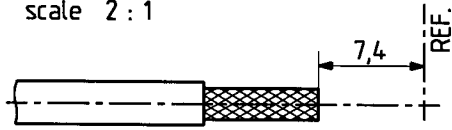

H+S 701 448.05

scale

4 : 1

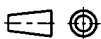

HUBER + SUHNER RFX

dimensions in mm

drawing number

4.13.32208

index

a

OZ drawing :