

TMOV®25S Varistor Series

Radial Lead Varistors

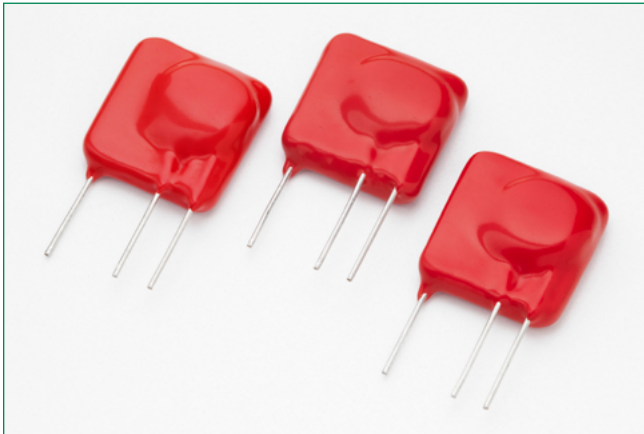

Description

Metal Oxide Varistors (MOVs) are rated for specific AC line operating voltages, and exceeding these limits through the application of a sustained abnormal over-voltage condition could result in overheating and damage to the MOV.

The Littelfuse TMOV®25S Varistor Series was designed to address this condition in a single integrated package.

The TMOV®25S Varistor Series incorporates a patented integrated thermally responsive element within the body of the device which will open-circuit the varistor in case of overheating due to the abnormal over-voltage events.

The TMOV®25S Varistor Series meets the surge suppressor component recognition requirements of UL1449 3rd edition for both cord connected and permanently connected SPD end products.

Additional Information



Resources



Accessories



Samples

Agency Approvals

Agency	Agency Approval	Agency File Number
	UL1449	E320116
	IEC 61051-1, IEC 61051-2, IEC 60950-1 (Annex Q)	J 50472797

Features & Benefits

- RoHS Compliant and Lead-free
- Wave solderable
- Standard Operating Voltage Range Compatible with Common AC Line Voltages (115VAC to 750VAC)
- High peak surge current
- rating up to 20kA at single 8/20µS impulse
- Standard lead form and spacing option
- -55°C to +85°C operating temperature range

Applications

- SPD Products
- AC Panel Protection Modules
- AC/DC power supplies
- UPS (Uninterruptible Power Supply)

TMOV[®]25S Varistor Series

Radial Lead Varistors

Absolute Maximum Ratings

- For ratings of individual members of a series, see Device Ratings and Specifications chart.

Reading	TMOV [®] 25S Varistor Series	Units
Continuous		
AC Voltage Range ($V_{M(AC)(RMS)}$)	115 to 750	V
Transient		
Peak Pulse Current (I_{TM})	-	-
For 8x20 μ s Current Wave, single pulse	20,000	A
Single-Pulse Energy Capability	-	-
For 2ms Current Wave	170 to 670	J
Operating Ambient Temperature Range (T_A)	-55 to +85	°C
Storage Temperature Range (T_{STG})	-55 to +125	°C
Temperature Coefficient (αV) of Clamping Voltage (V_C) at Specified Test Current	<0.01	%/°C
Hi-Pot Encapsulation (COATING Isolation Voltage Capability)	2,500	V
Thermal Protection Isolation Voltage Capability (when operated)*	600*	V
COATING Insulation Resistance	1,000	M Ω

Note: * - See notes under Device Ratings & Specifications section for more information

CAUTION: Stresses above those listed in "Absolute Maximum Ratings" may cause permanent damage to the device. This is a stress only rating and operation of the device at these or any other conditions above those indicated in the operational sections of this specification is not implied.

Device Ratings & Specifications

2 Leaded Device - Without Indicator Lead		3 Leaded Device - With Indicator Lead Option		Model Size Disc Diameter (mm)	Maximum Rating (85°C)				Specifications (25 °C)			
					Continuous		Transient		Varistor Voltage @ 1mA Test Current		Clamping Voltage @ 100A Current 8/20 μ s	Typical Capacitance (f=1MHz)
Part Number	Branding	Part Number	Branding		AC Volts	DC Volts	Energy 2ms	Peak Current 8/20 μ s				
					$V_{M(AC)(RMS)}$	$V_{M(DC)}$	W_{TM}	I_{TM} 1xPulse				
					(V)	(V)	(J)	(A)	(V)	(V)	(V)	(pF)
TMOV25SP115E	P25T115E	TMOV25SP115M	P25T115M	25	115	150	170	20000	162	198	295	3200
TMOV25SP130E	P25T130E	TMOV25SP130M	P25T130M		130	170	190		184.5	225.5	335	2800
TMOV25SP140E	P25T140E	TMOV25SP140M	P25T140M		140	180	210		198	242	355	2500
TMOV25SP150E	P25T150E	TMOV25SP150M	P25T150M		150	200	220		216	264	390	2300
TMOV25SP175E	P25T175E	TMOV25SP175M	P25T175M		175	225	250		243	297	450	1900
TMOV25SP200E	P25T200E	TMOV25SP200M	P25T200M		200	265	270		283	345	530	1700
TMOV25SP230E	P25T230E	TMOV25SP230M	P25T230M		230	300	300		324	396	585	1500
TMOV25SP250E	P25T250E	TMOV25SP250M	P25T250M		250	320	330		351	429	640	1400
TMOV25SP275E	P25T275E	TMOV25SP275M	P25T275M		275	350	350		387	473	700	1250
TMOV25SP300E	P25T300E	TMOV25SP300M	P25T300M		300	385	370		423	517	765	1150
TMOV25SP320E	P25T320E	TMOV25SP320M	P25T320M		320	420	390		459	561	825	1080
TMOV25SP385E	P25T385E	TMOV25SP385M	P25T385M		385	505	430		558	682	1010	900
TMOV25SP420E	P25T420E	TMOV25SP420M	P25T420M		420	560	460		612	748	1100	820
TMOV25SP440E	P25T440E	TMOV25SP440M	P25T440M		440	585	470		643.5	786.5	1160	790
TMOV25SP460E	P25T460E	TMOV25SP460M	P25T460M		460	615	490		675	825	1220	750
TMOV25SP510E	P25T510E	TMOV25SP510M	P25T510M		510	670	520		738	902	1335	680
TMOV25SP550E	P25T550E	TMOV25SP550M	P25T550M		550	745	550		819	1001	1475	630
TMOV25SP625E	P25T625E	TMOV25SP625M	P25T625M		625	825	600		900	1100	1625	550
TMOV25SP750E	P25T750E	TMOV25SP750M	P25T750M		750	970	670		1080	1320	1950	460

Notes: Average power dissipation of transients should not exceed 1.5 watts.

TMOV[®] 25S Varistor Series

Radial Lead Varistors

Thermal Characteristics

Typical time to open circuit under UL 1449 Abnormal Overvoltage Limited Current Test:

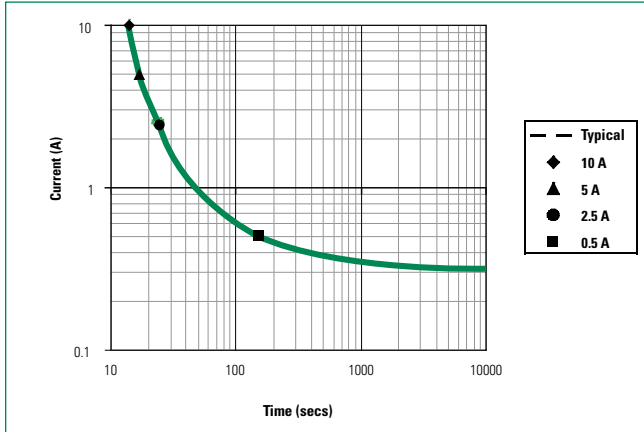

Peak Current & Energy Derating Curve

For applications exceeding 85°C ambient temperature, the peak surge current and energy ratings must be reduced as shown.

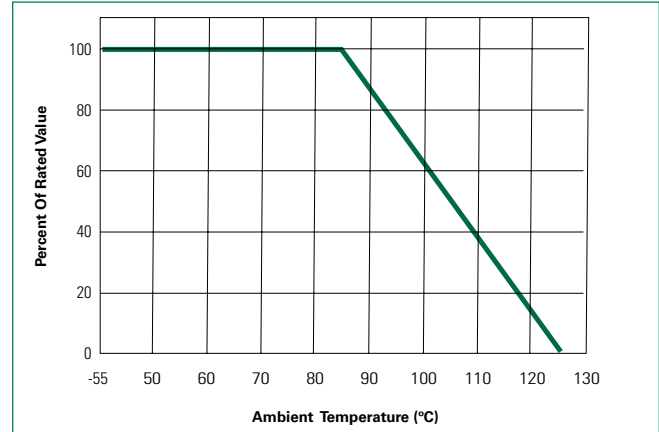

Transient V-I Characteristic Curves

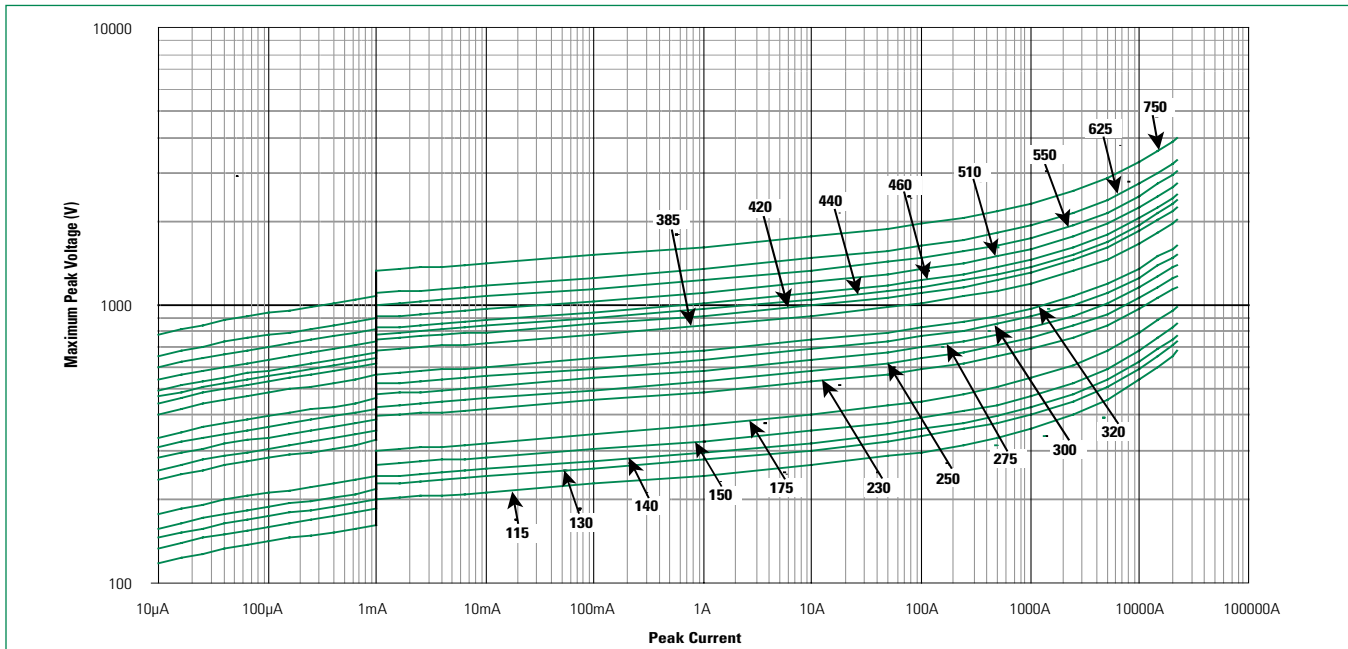

TMOV[®]25S Varistor Series

Radial Lead Varistors

Pulse Rating Curve

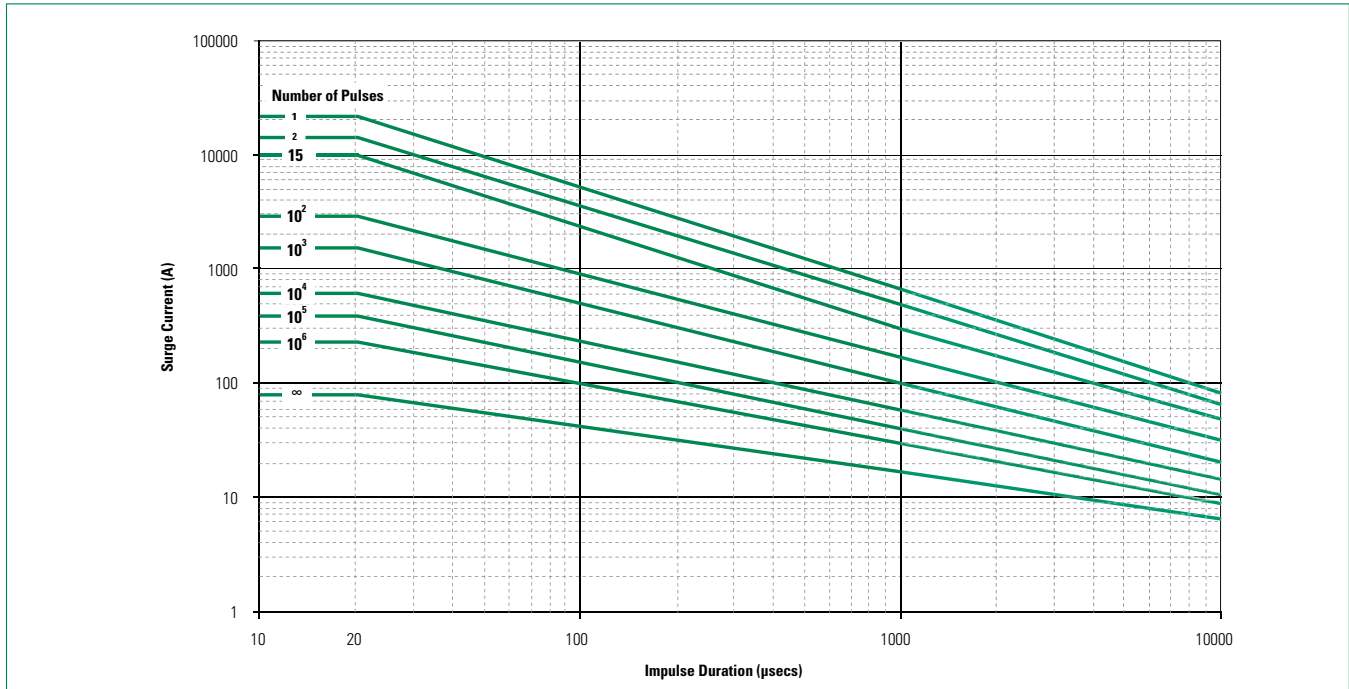

Wave Solder Profile

Because the TMOV[®]25S Varistor Series contains a thermally responsive device, care must be taken when soldering the device into place. Two soldering methods are possible. Firstly, hand soldering: We recommend the use of pliers to heat-sink the leads of the device. Secondly, wave-soldering: This is a strenuous process requiring pre-heat stages to reduce the stresses on devices.

It is critically important that all preheat stage and the solder bath temperatures are rigidly controlled. The recommended solder for the TMOV[®] Varistor Series is a 62/36/2 (Sn/Pb/Ag), 60/40 (Sn/Pb) or 63/37 (Sn/Pb). Littelfuse also recommends an RMA solder flux. SAC solders (SnAgCu) are recommended for Lead-free applications.

Soldering Profile

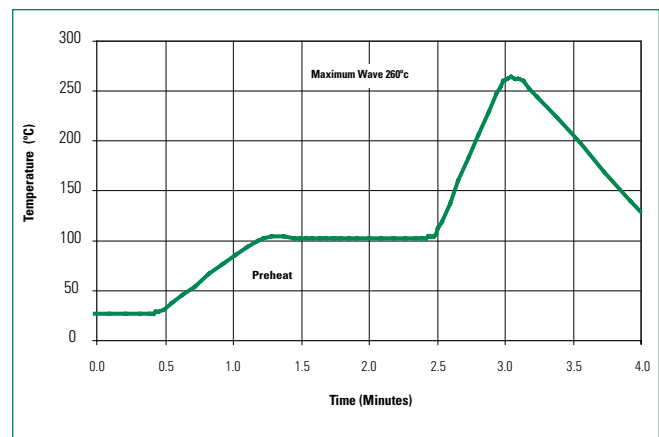

Physical Specifications

Lead Material	Copper Clad Steel Wire
Soldering Characteristics	Solderability per MIL-STD-202, Method 208
Insulating Material	Cured, flame retardant epoxy polymer meets UL94V-0 requirements
Device Labeling	Marked with LF, voltage, UL logos, and date code

Environmental Specifications

Operating/Storage Temperature	-55°C to +85°C
Humidity Aging	+85°C, 85%R.H., 1000 hours -/+10% typical voltage change
Thermal Shock	+85°C to -40°C 5 times -/+10% typical voltage change
Solvent Resistance	MIL-STD-202, Method 215
Moisture Sensitivity	Level 1, J-STD-020

TMOV[®] 25S Varistor Series

Radial Lead Varistors

Application Example

The application example left shows how the indicator lead on the TMOV[®] Varistor can be used to indicate that thermal element has been opened. This signifies that the circuit is no longer protected from transients by the MOV.

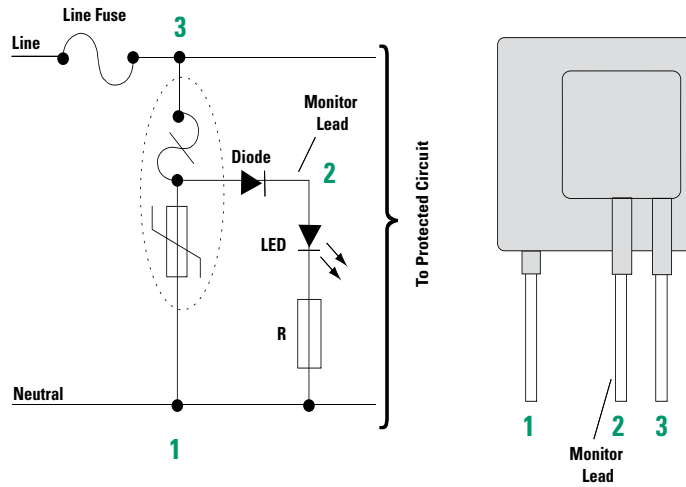

Dimensions

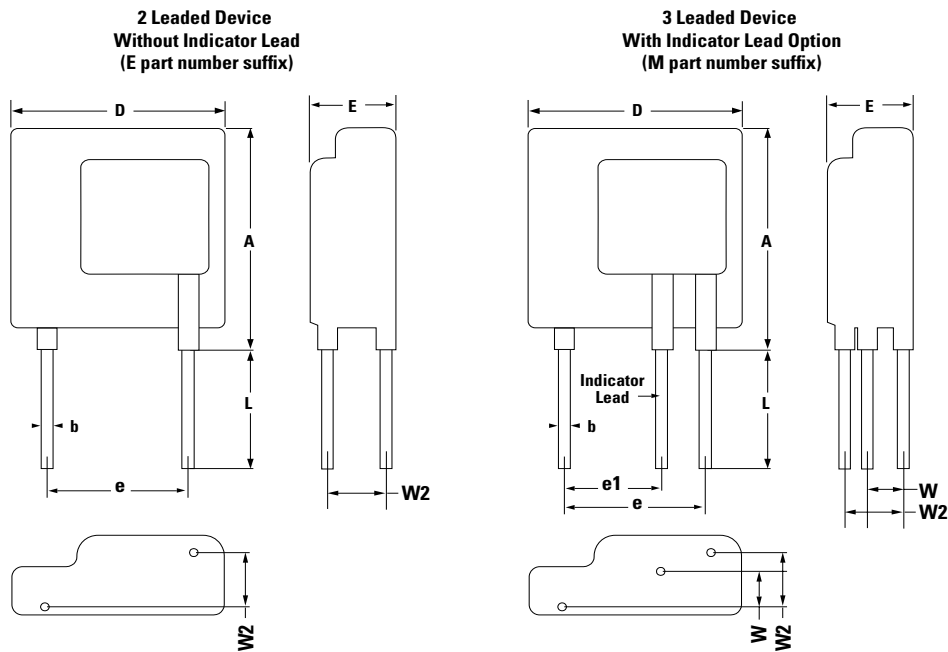

TMOV[®]25S Varistor Series

Radial Lead Varistors

Product Dimensions (mm)

Part Number	Part Number	W _{MIN}	W _{MAX}	W2	E _{MAX}	A _{MAX}	b _{MIN}	b _{MAX}	D _{MAX}	e	e1	L
TMOV25SP115E	TMOV25SP115M	1.5	2.7	3.6+/-1	11.7	32.5	0.95	1.05	26.5	19.2 +/-1	12.7 +/-1	12.7 Min.
TMOV25SP130E	TMOV25SP130M	1.6	2.9	3.7+/-1	11.9							
TMOV25SP140E	TMOV25SP140M	1.7	3.0	3.8+/-1	12.0							
TMOV25SP150E	TMOV25SP150M	1.8	3.1	3.9+/-1	12.1							
TMOV25SP175E	TMOV25SP175M	1.9	3.3	4.1+/-1	12.3							
TMOV25SP200E	TMOV25SP200M	1.9	3.3	4.1+/-1	12.3							
TMOV25SP230E	TMOV25SP230M	2.0	3.4	4.2+/-1	12.4							
TMOV25SP250E	TMOV25SP250M	2.1	3.5	4.3+/-1	12.5							
TMOV25SP275E	TMOV25SP275M	2.3	3.7	4.5+/-1	12.7							
TMOV25SP300E	TMOV25SP300M	2.4	3.9	4.6+/-1	12.9							
TMOV25SP320E	TMOV25SP320M	2.6	4.1	4.8+/-1	13.1							
TMOV25SP385E	TMOV25SP385M	3.0	4.7	5.3+/-1	13.7							
TMOV25SP420E	TMOV25SP420M	3.3	5.0	5.6+/-1	14.0							
TMOV25SP440E	TMOV25SP440M	3.4	5.2	5.8+/-1	14.2							
TMOV25SP460E	TMOV25SP460M	3.6	5.4	6+/-1	14.4							
TMOV25SP510E	TMOV25SP510M	3.9	5.7	6.3+/-1	14.7							
TMOV25SP550E	TMOV25SP550M	4.2	6.2	6.7+/-1	15.2							
TMOV25SP625E	TMOV25SP625M	4.6	6.6	7.1+/-1	15.6							
TMOV25SP750E	TMOV25SP750M	5.4	7.7	8.0+/-1	16.7							

Part Numbering System

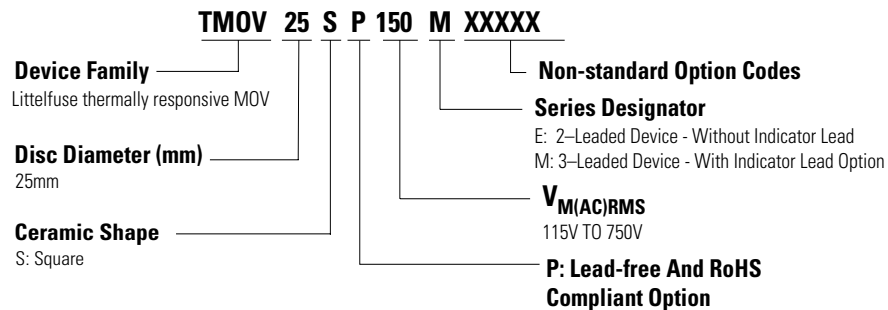

Disclaimer Notice - Information furnished is believed to be accurate and reliable. However, users should independently evaluate the suitability of and test each product selected for their own applications. Littelfuse products are not designed for, and may not be used in, all applications. Read complete Disclaimer Notice at www.littelfuse.com/disclaimer-electronics.

Mouser Electronics

Authorized Distributor

Click to View Pricing, Inventory, Delivery & Lifecycle Information:

Littelfuse:

[TMOV25SP115M](#) [TMOV25SP130M](#) [TMOV25SP140M](#) [TMOV25SP150M](#) [TMOV25SP175M](#) [TMOV25SP230M](#)
[TMOV25SP250M](#) [TMOV25SP275M](#) [TMOV25SP300M](#) [TMOV25SP320M](#) [TMOV25SP385M](#) [TMOV25SP420M](#)
[TMOV25SP440M](#) [TMOV25SP460M](#) [TMOV25SP510M](#) [TMOV25SP550M](#) [TMOV25SP625M](#) [TMOV25SP750M](#)
[TMOV25SP200M](#) [TMOV25SP550E](#) [TMOV25SP320E](#) [TMOV25SP150E](#) [TMOV25SP440E](#) [TMOV25SP175E](#)
[TMOV25SP300E](#) [TMOV25SP200E](#) [TMOV25SP230E](#) [TMOV25SP250E](#) [TMOV25SP140E](#) [TMOV25SP115E](#)
[TMOV25SP385E](#) [TMOV25SP460E](#) [TMOV25SP750E](#) [TMOV25SP420E](#) [TMOV25SP510E](#) [TMOV25SP625E](#)
[TMOV25SP130E](#) [TMOV25SP275E](#) [TMOV25SP0E](#) [TMOV25SP385EX3661](#) [TMOV25SP320EX3661](#)
[TMOV25SP550EX3661](#) [TMOV25SP750EX3661](#) [TMOV25SP130EX3661](#) [TMOV25SP275EX3661](#)