

Features

- Low Profile Package for Surface Mounting(Flat Handling Surface for Accurate Placement)
- Zener Voltage 5.1V to 200V
- Available on Tape and Reel(See E1A Std RS-481)
- Halogen Free. "Green" Device (Note 1)
- Moisture Sensitivity Level 1
- Epoxy Meets UL 94 V-0 Flammability Rating
- Lead Free Finish/RoHS Compliant (Note 2) ("P" Suffix Designates Compliant. See Ordering Information)

Maximum Ratings

- Operating Junction Temperature Range: -55°C to +150°C
- Storage Temperature Range: -55°C to +150°C
- Thermal Resistance: 15°C/W Junction to Lead
- Thermal Resistance: 90°C/W Junction to Ambient(Note3)

| Parameter | Symbol | Rating | Conditions |
|--------------------------------|------------|--------|-------------|
| Steady State Power Dissipation | $P_{(AV)}$ | 5.0W | Note 4 |
| Maximum Forward Voltage | V_F | 1.2V | $I_F=1.0mA$ |

Note:

- 1.Halogen free "Green"products are defined as those which contain <900ppm bromine, <900ppm chlorine (<1500ppm total Br + Cl) and <1000ppm antimony compounds.
- 2.High Temperature Solder Exemption Applied, See EU Directive Annex 7a.
- 3.Ambient Temperature at 15°C = T_A at Mounting Plane. Derate Linearly Above 15°C to Zero Power at 150°C
- 4.Lead Temperature at 75°C = T_L at Mounting Plane. Derate Linearly Above 75°C to Zero Power at 150°C

Device Marking:

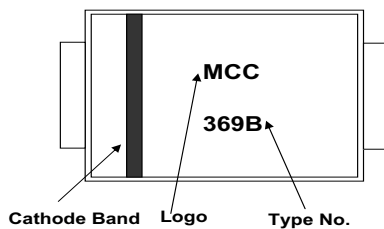

For Example: 339B for SMBJ5339B
369B for SMBJ5369B

5.0 Watt Surface Mount Silicon Zener Diodes 5.1V to 200V

SMB (DO-214AA) (LEAD FRAME)

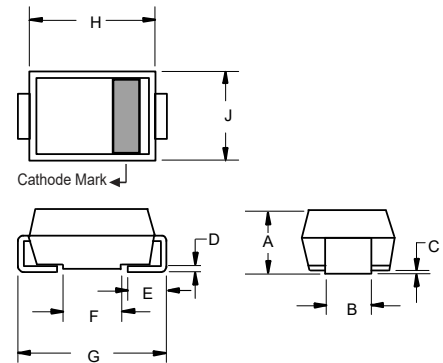

| DIM | INCHES | | MM | | NOTE |
|-----|--------|-------|------|------|------|
| | MIN | MAX | MIN | MAX | |
| A | 0.079 | 0.103 | 2.00 | 2.62 | |
| B | 0.075 | 0.087 | 1.91 | 2.21 | |
| C | 0.002 | 0.008 | 0.05 | 0.20 | |
| D | 0.006 | 0.012 | 0.15 | 0.31 | |
| E | 0.030 | 0.060 | 0.76 | 1.52 | |
| F | 0.065 | 0.091 | 1.65 | 2.32 | |
| G | 0.200 | 0.220 | 5.08 | 5.59 | |
| H | 0.160 | 0.191 | 4.06 | 4.85 | |
| J | 0.130 | 0.155 | 3.30 | 3.94 | |

SUGGESTED SOLDER PAD LAYOUT

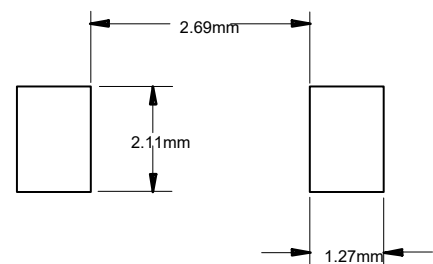

Electrical Characteristics @ 25°C Unless Otherwise Specified

| MCC Part Number | Regulator Voltage | Test Current | Maximum Dynamic Impedance | Maximum Reverse Current | Test Voltage | Maximum Regulator Current | Maximum Dynamic Knee Impedance | Maximum Surge Current | Maximum Voltage Regulation |
|-----------------|-------------------|--------------|---------------------------|-------------------------|--------------|---------------------------|--------------------------------|-----------------------|----------------------------|
| | V_Z | I_Z | Z_{ZT} | I_R | V_R | I_{ZM} | $Z_{Zk} @ 1.0mA$ | I_{ZSM} | |
| | V | mA | Ω | μA | V | mA | Ω | A | V |
| SMBJ5338B | 5.1 | 240 | 1.5 | 1 | 1 | 930 | 400 | 14.4 | 0.39 |
| SMBJ5339B | 5.6 | 220 | 1 | 1 | 2 | 865 | 400 | 13.4 | 0.25 |
| SMBJ5340B | 6 | 200 | 1 | 1 | 3 | 790 | 300 | 12.7 | 0.19 |
| SMBJ5341B | 6.2 | 200 | 1 | 1 | 3 | 765 | 200 | 12.4 | 0.1 |
| SMBJ5342B | 6.8 | 175 | 1 | 10 | 5.2 | 700 | 200 | 11.5 | 0.15 |
| SMBJ5343B | 7.5 | 175 | 1.5 | 10 | 5.7 | 630 | 200 | 10.7 | 0.15 |
| SMBJ5344B | 8.2 | 150 | 1.5 | 10 | 6.2 | 580 | 200 | 10 | 0.2 |
| SMBJ5345B | 8.7 | 150 | 2 | 10 | 6.6 | 545 | 200 | 9.5 | 0.2 |
| SMBJ5346B | 9.1 | 150 | 2 | 7.5 | 6.9 | 520 | 150 | 9.2 | 0.22 |
| SMBJ5347B | 10 | 125 | 2 | 5 | 7.6 | 475 | 125 | 8.6 | 0.22 |
| SMBJ5348B | 11 | 125 | 2.5 | 5 | 8.4 | 430 | 125 | 8 | 0.25 |
| SMBJ5349B | 12 | 100 | 2.5 | 2 | 9.1 | 395 | 125 | 7.5 | 0.25 |
| SMBJ5350B | 13 | 100 | 2.5 | 1 | 9.9 | 365 | 100 | 7 | 0.25 |
| SMBJ5351B | 14 | 100 | 2.5 | 1 | 10.6 | 340 | 75 | 6.7 | 0.25 |
| SMBJ5352B | 15 | 75 | 2.5 | 1 | 11.5 | 315 | 75 | 6.3 | 0.25 |
| SMBJ5353B | 16 | 75 | 2.5 | 1 | 12.2 | 295 | 75 | 6 | 0.3 |
| SMBJ5354B | 17 | 70 | 2.5 | 0.5 | 12.9 | 280 | 75 | 5.8 | 0.35 |
| SMBJ5355B | 18 | 65 | 2.5 | 0.5 | 13.7 | 264 | 75 | 5.5 | 0.4 |
| SMBJ5356B | 19 | 65 | 3 | 0.5 | 14.4 | 250 | 75 | 5.3 | 0.4 |
| SMBJ5357B | 20 | 65 | 3 | 0.5 | 15.2 | 237 | 75 | 5.1 | 0.4 |
| SMBJ5358B | 22 | 50 | 3.5 | 0.5 | 16.7 | 216 | 75 | 4.7 | 0.45 |
| SMBJ5359B | 24 | 50 | 3.5 | 0.5 | 18.2 | 198 | 100 | 4.4 | 0.55 |
| SMBJ5360B | 25 | 50 | 4 | 0.5 | 19 | 190 | 110 | 4.3 | 0.55 |
| SMBJ5361B | 27 | 50 | 5 | 0.5 | 20.6 | 176 | 120 | 4.1 | 0.6 |
| SMBJ5362B | 28 | 50 | 6 | 0.5 | 21.2 | 170 | 130 | 3.9 | 0.6 |
| SMBJ5363B | 30 | 40 | 8 | 0.5 | 22.8 | 158 | 140 | 3.7 | 0.6 |
| SMBJ5364B | 33 | 40 | 10 | 0.5 | 25.1 | 144 | 150 | 3.5 | 0.6 |
| SMBJ5365B | 36 | 30 | 11 | 0.5 | 27.4 | 132 | 160 | 3.3 | 0.65 |
| SMBJ5366B | 39 | 30 | 14 | 0.5 | 29.7 | 122 | 170 | 3.1 | 0.65 |
| SMBJ5367B | 43 | 30 | 20 | 0.5 | 32.7 | 110 | 190 | 2.8 | 0.7 |
| SMBJ5368B | 47 | 25 | 25 | 0.5 | 35.8 | 100 | 210 | 2.7 | 0.8 |
| SMBJ5369B | 51 | 25 | 27 | 0.5 | 38.8 | 93 | 230 | 2.5 | 0.9 |
| SMBJ5370B | 56 | 20 | 35 | 0.5 | 42.6 | 86 | 280 | 2.3 | 1 |
| SMBJ5371B | 60 | 20 | 40 | 0.5 | 45.5 | 79 | 350 | 2.2 | 1.2 |
| SMBJ5372B | 62 | 20 | 42 | 0.5 | 47.1 | 76 | 400 | 2.1 | 1.35 |
| SMBJ5373B | 68 | 20 | 44 | 0.5 | 51.7 | 70 | 500 | 2 | 1.5 |
| SMBJ5374B | 75 | 20 | 45 | 0.5 | 56 | 63 | 620 | 1.9 | 1.6 |
| SMBJ5375B | 82 | 15 | 65 | 0.5 | 62.2 | 58 | 720 | 1.8 | 1.8 |
| SMBJ5376B | 87 | 15 | 75 | 0.5 | 66 | 54.5 | 760 | 1.7 | 2 |
| SMBJ5377B | 91 | 15 | 75 | 0.5 | 69.2 | 52.5 | 760 | 1.6 | 2.2 |
| SMBJ5378B | 100 | 12 | 90 | 0.5 | 76 | 47.5 | 800 | 1.5 | 2.3 |
| SMBJ5379B | 110 | 12 | 125 | 0.5 | 83.6 | 43 | 1000 | 1.4 | 2.5 |
| SMBJ5380B | 120 | 10 | 170 | 0.5 | 91.2 | 39.5 | 1150 | 1.3 | 2.5 |
| SMBJ5381B | 130 | 10 | 190 | 0.5 | 98.8 | 36.6 | 1250 | 1.2 | 2.5 |
| SMBJ5382B | 140 | 8.0 | 230 | 0.5 | 106 | 34 | 1500 | 1.2 | 2.5 |
| SMBJ5383B | 150 | 8.0 | 330 | 0.5 | 114 | 31.6 | 1500 | 1.1 | 3 |
| SMBJ5384B | 160 | 8.0 | 350 | 0.5 | 122 | 29.4 | 1650 | 1.1 | 3 |
| SMBJ5385B | 170 | 8.0 | 380 | 0.5 | 129 | 28 | 1750 | 1.0 | 3 |
| SMBJ5386B | 180 | 5.0 | 430 | 0.5 | 137 | 26.4 | 1750 | 1.0 | 4 |
| SMBJ5387B | 190 | 5.0 | 450 | 0.5 | 144 | 25 | 1850 | 0.9 | 5 |
| SMBJ5388B | 200 | 5.0 | 480 | 0.5 | 152 | 23.6 | 1850 | 0.9 | 5 |

Remarks:

1. Devices Listed Have a $\pm 5\%$ Tolerance on Nominal V_Z . Suffix C Denotes a +2%
2. Nominal Zener Voltage (V_Z) is Tested With a 40 +/-10 Milliseconds Pulse Current at 25°C to Avoid Self-heat Affection.
3. The Zener Impedance (Z_{ZT} or Z_{ZK}) is Derived from The 60Hz AC Voltage, Which Results When an AC Current Having a rms value Equal to 10% of the DC Zener Current (I_{ZT} or I_{ZK}) Respectively.
4. The Maximum Reverse(Leakage) Current is Specified for Devices With $\pm 20\%$ and $\pm 10\%$ Voltage Tolerances on Nominal V_Z in Another Column.
5. The Maximum Zener Current(I_{ZM}) Shown is for $\pm 5\%$ Tolerance Devices. I_{ZM} for $\pm 10\%$ and $\pm 20\%$ Devices Can be Calculated Using the Formula:

$$I_{ZM} = \frac{P}{V_{ZM}}$$

Where " V_{ZM} " is V_Z at The High End of The Voltage Tolerance Specified and "P" is The Rated Power of The Device.

6. The Surge Current (I_{ZM}) is Specified As The Maximum Peak of a Nonrecurring Sine Wave of 8.3 Milliseconds Duration.
7. Voltage Regulation (ΔV_Z) is The Difference Between The Voltage Measured at 10% and 50% (I_{ZM}).

Curve Characteristics

Fig. 1 - Power Derating Curve

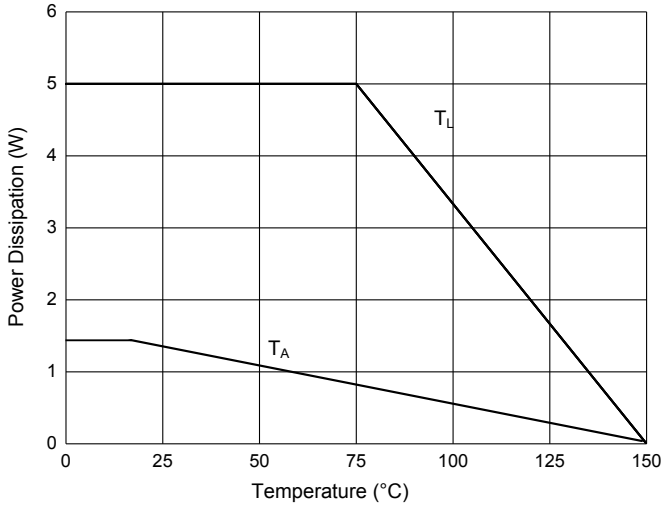

Fig. 2 - Typical Zener Breakdown Characteristics



Fig. H - Typical Zener Breakdown Characteristics

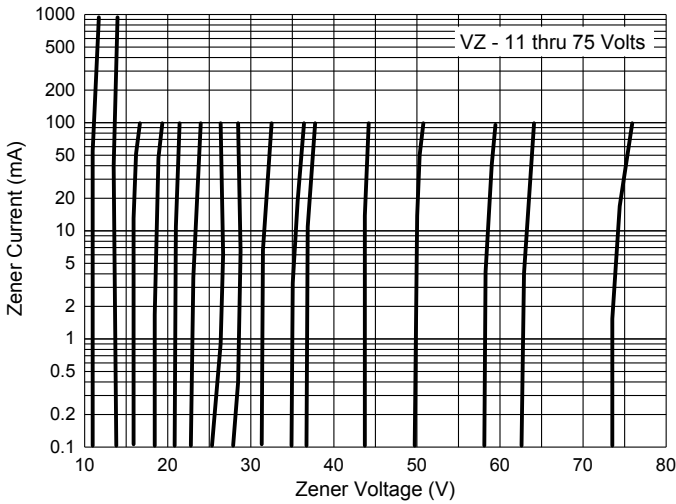

Fig. 4 - Typical Zener Breakdown Characteristics



Fig. 5 - Maximum Surge Current VS Nominal Vz

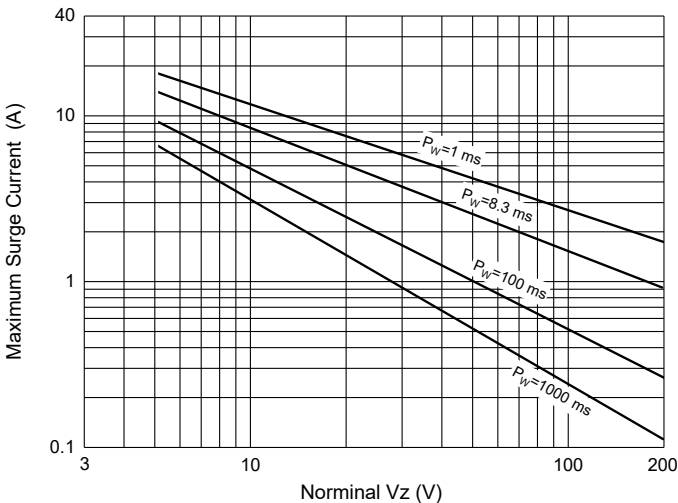
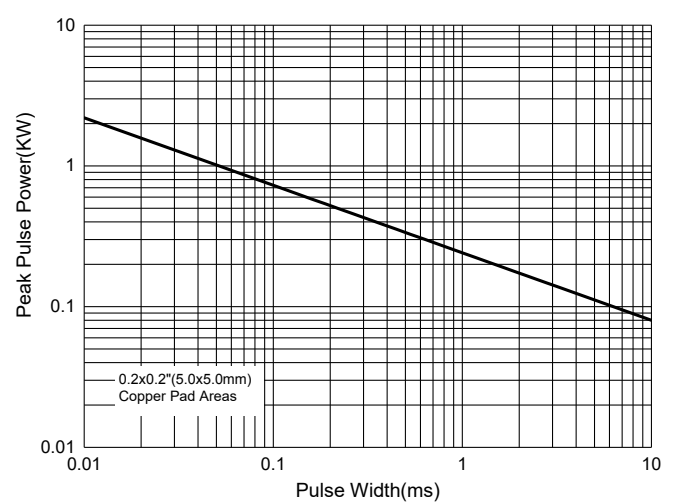

Fig. 6 - Non-Repetitive Peak Pulse Power



Ordering Information

| Device | Packing |
|----------------|----------------------|
| Part Number-TP | Tape&Reel:3Kpcs/Reel |

IMPORTANT NOTICE

Micro Commercial Components Corp. reserves the right to make changes without further notice to any product herein to make corrections, modifications, enhancements, improvements, or other changes. **Micro Commercial Components Corp.** does not assume any liability arising out of the application or use of any product described herein; neither does it convey any license under its patent rights, nor the rights of others. The user of products in such applications shall assume all risks of such use and will agree to hold **Micro Commercial Components Corp.** and all the companies whose products are represented on our website, harmless against all damages. **Micro Commercial Components Corp.** products are sold subject to the general terms and conditions of commercial sale, as published at <https://www.mccsemi.com/Home/TermsAndConditions>.

LIFE SUPPORT

MCC's products are not authorized for use as critical components in life support devices or systems without the express written approval of Micro Commercial Components Corporation.

CUSTOMER AWARENESS

Counterfeiting of semiconductor parts is a growing problem in the industry. Micro Commercial Components (MCC) is taking strong measures to protect ourselves and our customers from the proliferation of counterfeit parts. MCC strongly encourages customers to purchase MCC parts either directly from MCC or from Authorized MCC Distributors who are listed by country on our web page cited below. Products customers buy either from MCC directly or from Authorized MCC Distributors are genuine parts, have full traceability, meet MCC's quality standards for handling and storage. **MCC will not provide any warranty coverage or other assistance for parts bought from Unauthorized Sources.** MCC is committed to combat this global problem and encourage our customers to do their part in stopping this practice by buying direct or from authorized distributors.