

- Subminiature 20 L x 9.90 W x 9.90 H mm
(0.79 L x 0.39 W x 0.39 H in)
- Low power consumption (200 mW)
- Sealed construction permits automatic soldering and cleaning of the PC board
- High-capacity and latching types available
- Meets FCC Part 68 requirements
- Unique moving magnet armature (Moving Loop System) reduces relay size, magnetic interference, and contact bounce time



Ordering Information

To Order: Select the part number and add the desired coil voltage rating (e.g., G6B-1114-US-DC6).

■ NON-LATCHING

Type	Contact form	Construction	Part number
Standard	SPST-NO	Sealed	G6B-1114P-US
	SPST-NO + SPST-NC		G6B-2114P-US
	DPST-NO		G6B-2214P-US
	DPST-NC		G6B-2014P-US
High-capacity LED indicator & diode surge suppression	SPST-NO	Sealed	G6B-1174P-US
		Semi-sealed	G6B-1177P-ND-US

■ LATCHING

Type	Contact form	Part number
Single coil latching	SPST-NO	G6BU-1114P-US
Dual coil latching		G6BK-1114P-US

■ ACCESSORIES

Back connecting sockets

Relay	Part number
G6B-1114P-US	P6B-04P
G6B-1174P-US	
G6B-1177P-US	
G6BU-1114P-US	
G6B-2114P-US	P6B-26P
G6B-2214P-US	
G6B-2014P-US	
G6BK-1114P-US	P6B-06P

Specifications

■ CONTACT DATA

Non-latching standard and high-capacity types

Load	Standard		High-capacity	
	Resistive load (p.f. = 1)	Inductive load (p.f. = 0.4) (L/R = 7 ms)	Resistive load (p.f. = 1)	Inductive load (p.f. = 0.4) (L/R = 7 ms)
Rated load	5 A at 250 VAC 5 A at 30 VDC	2 A at 250 VAC 2 A at 30 VDC	8 A at 250 VAC 8 A at 30 VDC	2 A at 250 VAC 2 A at 30 VDC
Contact material	AgCdO			
Carry current	5 A		8 A	
Max. operating voltage	380 VAC, 125 VDC			
Max. operating current	5 A		8 A	
Max. switching capacity	1,250 VA, 150 W	500 VA, 60 W	2,000 VA, 240 W	500 VA, 60 W
Min. permissible load	10 mA, 5 VDC		10 mA, 5 VDC	

Latching

Load	Resistive load (p.f. = 1)	Inductive load (p.f. = 0.4) (L/R = 7 ms)
Rated load	5A at 250 VAC 5 A at 30 VDC	2 A at 250 VAC 2 A at 30 VDC
Contact material	AgCdO	
Carry current	5 A	
Max. operating voltage	380 VAC, 125 VDC	
Max. operating current	5 A	
Max. switching capacity	1,250 VA, 150 W	500 VA, 60 W
Min. permissible load	10 mA, 5 VDC	

■ COIL DATA

Non-latching, SPST-NO

Rated voltage (VDC)	Rated current (mA)	Coil resistance (Ω)	Pick-up voltage	Dropout voltage	Max. voltage	Power consumption (mW)
			% of rated voltage			
3	67	45	70% max.	10% min.	130% max.	Approx. 200
5	40	125				
6	33.30	180				
12	16.70	720				
24	8.30	2,880				

Non-latching, LED indicator type

Rated voltage (VDC)	Rated current (mA)	Coil resistance (Ω)	Pick-up voltage	Dropout voltage	Max. voltage	Power consumption (mW)
			% of rated voltage			
5	43	116	70% max.	10% min.	130% max.	215
12	19.70	610				236
24	11.30	2,120				271

Note: The rated current and coil resistance are measured at a coil temperature of 23°C (73°F) with a tolerance of $\pm 10\%$.

■ COIL DATA

Non-latching, 2-pole type (SPST-NO + SPST-NC, DPST-NO, DPST-NC)

Rated voltage (VDC)	Rated current (mA)	Coil resistance (Ω)	Pick-up voltage	Dropout voltage	Max. voltage	Power consumption (mW)
			% of rated voltage			
3	100	30	80% max.	10% min.	110% max.	Approx. 300
5	60	83.30				
6	50	120				
12	25	480				
24	12.50	1,920				
48	6.25	7,680				

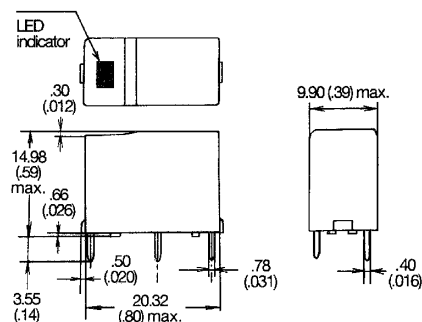

**Terminal arrangement/
Internal connections**
(Bottom view)

Latching, single-winding type

Rated voltage (VDC)	At set			Set pick-up voltage	Reset pick-up voltage	Maximum voltage	Power consumption (mW)
	Rated current (mA)	Coil resistance (Ω)	Coil inductance (ref. value) (H)				
3	67	45	0.18	70% max.	70% max.	160% max. at 23°C (73°F) 130% max. at 70°C (158°F)	Approx. 200
5	40	125	0.26				
6	33.30	180	0.28				
12	16.70	720	1.10				
24	8.30	2,880	4.10				

Latching, dual coil type - set/reset coil

Rated voltage (VDC)	Rated current (mA)	Coil resistance (Ω)	Coil inductance (ref. value) (H)		Set pick-up voltage	Reset pick-up voltage	Maximum voltage	Power consumption (mW)
			Armature OFF	Armature ON				
3	93.20	32.20	0.11	0.11	70% max.	70% max.	130% max. at 23°C (73°F)	Approx. 280
5	56	89.20	0.15	0.15				
6	46.80	128.50	0.18	0.18				
12	23.30	515	0.52	0.52				
24	11.70	2,060	1.20	1.20				

Note: The rated current and coil resistance are measured at a coil temperature of 23°C (73°F) with a tolerance of $\pm 10\%$.

CHARACTERISTICS

		Non-latching	Latching
Contact resistance		30 mΩ max	
Operate (set) time		10 ms max. (mean value: approx. 3 ms)	
Release (reset) time		10 ms max. (mean value: approx. 3 ms) (15 ms: LED indicator and diode surge suppression type)	
Bounce time	Operate (set)	3 ms (5 ms: 2-pole type)	5 ms max. (mean value approx. 3 ms)
	Release (reset)	1 ms	5 ms max. (mean value approx. 1 ms)
Operating frequency	Mechanical	18,000 operations/hour	
	Electrical	1,800 operations/hour (under rated load)	
Insulation resistance		1,000 MΩ min. (at 500 VDC)	
Dielectric strength		3,000 VAC, 50/60 Hz for 1 minute between coil and contacts, non-latching types	
		1,000 VAC, 50/60 Hz for 1 minute between contacts of same pole, non-latching types	
		2,000 VAC, 50/60 Hz for 1 minute between contact sets, non-latching types	
		250 VAC, 50/60 Hz for 1 minute between set and reset coils, latching types	
Vibration	Mechanical durability	10 to 55 Hz; 1.50 mm (0.06 in) double amplitude	
	Malfunction durability	10 to 55 Hz; 1.50 mm (0.06 in) double amplitude	
Shock	Mechanical durability	Approx. 100 G	
	Malfunction durability	Approx. 10 G	Approx. 30 G
Ambient temperature		-25 to 70°C (-13° to 158°F)	
Humidity		45 to 85% RH	
Service life	Mechanical	50 million operations min. (at operating frequency of 18,000 operations/hour)	
	Electrical	See "Characteristic Data"	
Weight	Standard type	Approx. 3.5 g (0.12 oz)	Approx. 3.7 g (0.13 oz)
	High-capacity type	4.6 g (0.16 oz.)	
	LED indicator and diode surge suppression type	5.4 g (0.19 oz)	
	2-pole type	4.5 g (0.16 oz)	

Note: Data shown are of initial value.

CHARACTERISTIC DATA

Standard, non-latching types

Maximum switching capacity

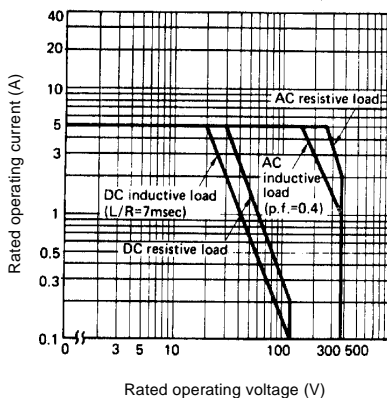

Electrical service life

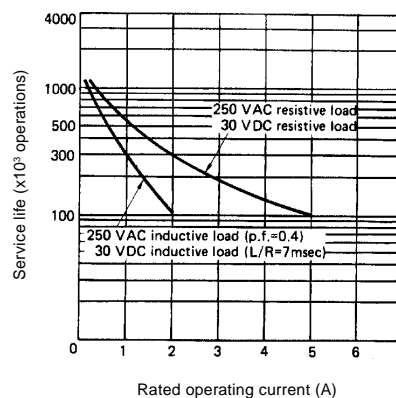

Ambient temperature vs. maximum voltage (reference only)

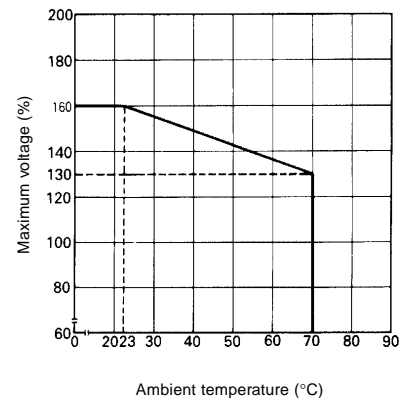

High-capacity, non-latching types

Maximum switching capacity

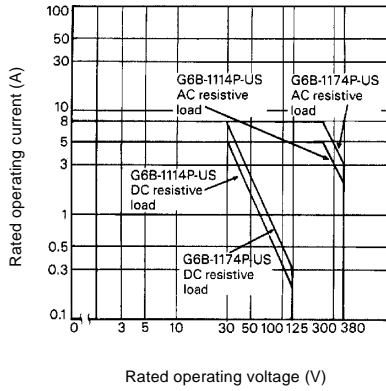

Electrical service life

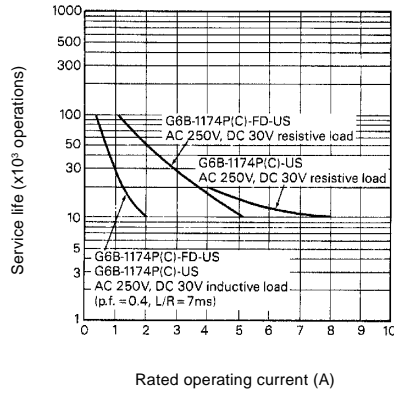

Latching types

Maximum switching capacity

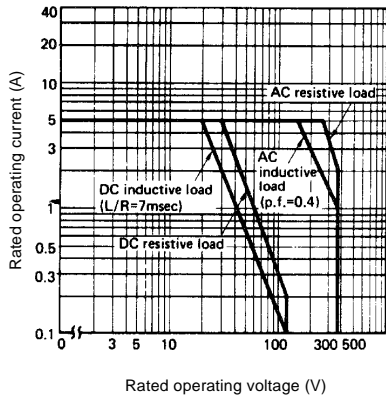

Electrical service life

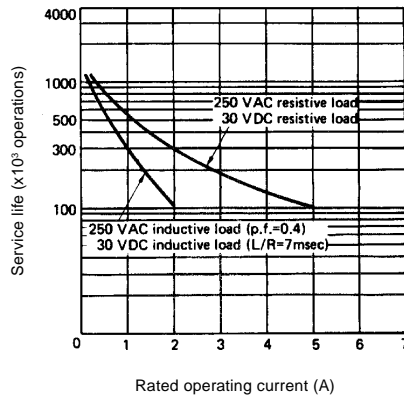

Ambient temperature vs. maximum voltage (reference only)

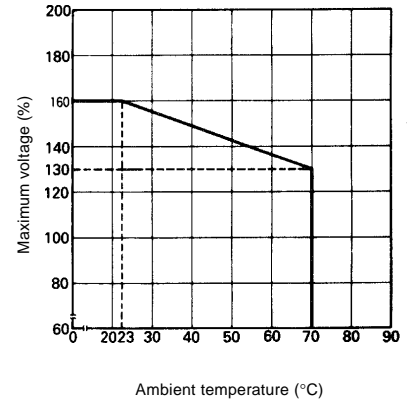

Dimensions

Unit: mm (inch)

■ NON-LATCHING RELAYS

1-pole type

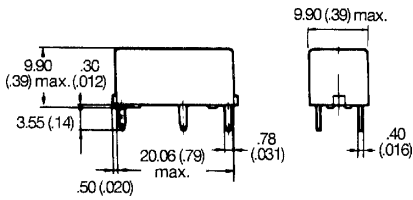

**Terminal arrangement/
Internal connections
(Bottom view)**

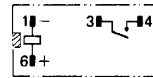

**Mounting holes
(Bottom view)**

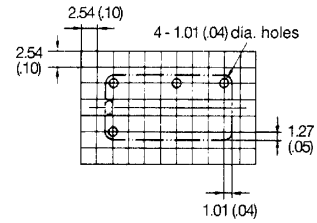

High-capacity type

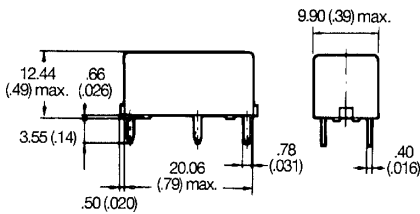

**Terminal arrangement/
Internal connections
(Bottom view)**

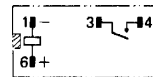

**Mounting holes
(Bottom view)**

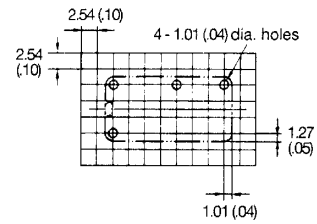

2-pole type

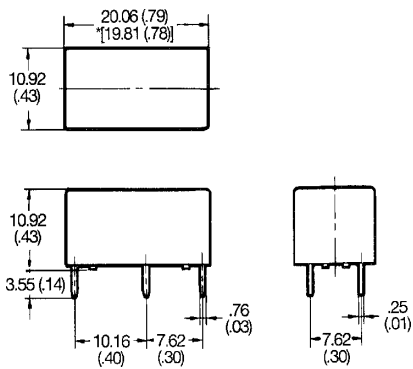

**Terminal arrangement/
Internal connections
(Bottom view)**

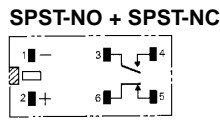
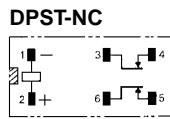
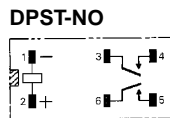

**Mounting holes
(Bottom view)**

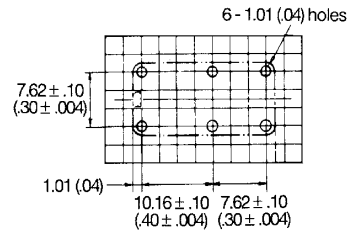

* Average value.

Note: and indicate mounting orientation marks.

■ LATCHING RELAYS

G6BU-1114P-US

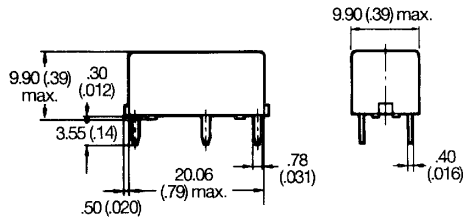

Terminal arrangement/
Internal connections

(Bottom view)

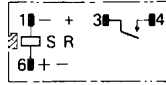

Mounting holes
(Bottom view)

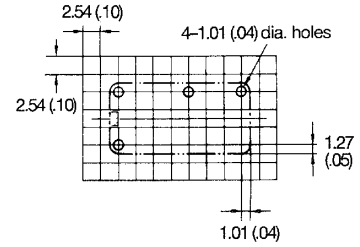

G6BK-1114P-US

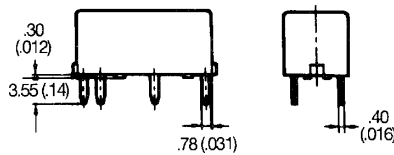

Terminal arrangement/
Internal connections

(Bottom view)

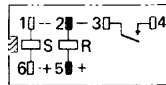

Mounting holes
(Bottom view)

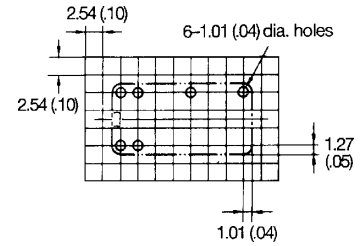

Note: Pay attention to the polarity of the coil.

■ ACCESSORIES

P6B-04P connecting socket

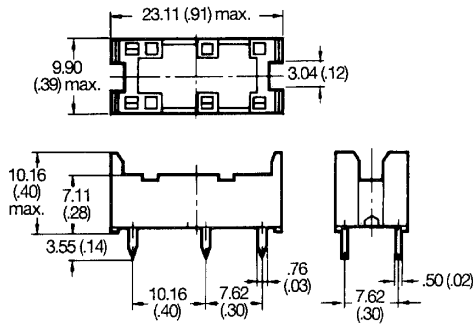

Mounting height of relay
width connecting socket

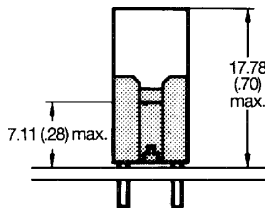

Mounting holes
(Bottom view)

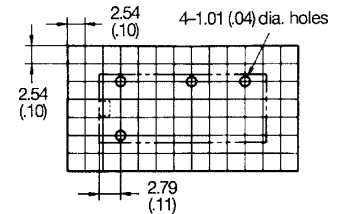

P6B-06P connecting socket

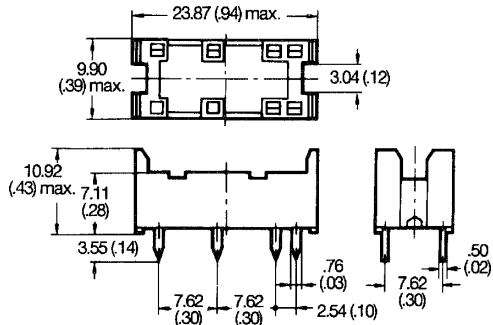

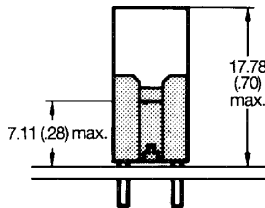

Mounting height of relay
width connecting socket

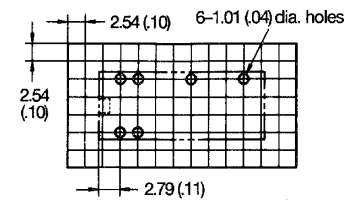

Mounting holes
(Bottom view)



Note:  and  indicate mounting orientation marks.

Unit: mm (inch)

■ ACCESSORIES (continued)

P6B-26P connecting socket

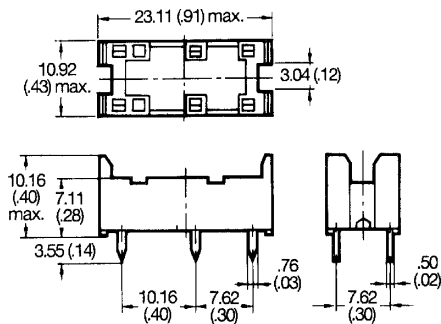

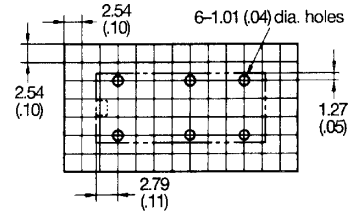

Mounting holes (Bottom view)

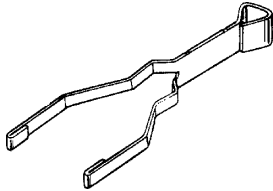

P6B-Y1 relay extractor



- Note: 1.  and  indicate mounting orientation marks.
2. Relay hold-down clip, P6B-C2, is available.

■ APPROVALS

UL (File No. E41643)/ CSA (File No. LR31928)

Type	Contact form	Coil ratings	Contact ratings
G6B-1114P-US	SPST-NO	3 to 24 VDC	5 A, 250 VAC (General purpose) 5 A, 30 VDC (Resistive) 1/6 HP, 250 VAC 1/8 HP, 250 VAC TV-2 360 WT, 120 VAC Tungsten
G6B-2014P-US G6B-2214P-US G6B-2114P-US	DPST-NC DPST-NO SPST-NC + SPST-NO	3 to 24 VDC	5 A, 250 VAC (General purpose) 5 A, 30 VDC (Resistive) 1/6 HP, 250 VAC 1/8 HP, 250 VAC 360 WT, 120 VAC Tungsten
G6B-1174P-US G6B-1177P-US G6B-1177P-ND-US	SPST-NO	3 to 24 VDC	8 A, 250 VAC (General purpose) 8 A, 30 VDC (Resistive) 1/6 HP, 250 VAC 1/8 HP, 250 VAC 360 WT, 120 VAC Tungsten
G6BU-1114P-US G6BK-1114P-US	SPST-NO	3 to 24 VDC	5 A, 250 VAC (General purpose) 5 A, 30 VDC (Resistive) 1/6 HP, 250 VAC (Motor load) 1/8 HP, 250 VAC (Motor load) 360 WT, 120 VAC Tungsten

- Note: 1. The rated values approved by each of the safety standards (e.g., UL and CSA) may be different from the performance characteristics individually defined in this catalog.
2. In the interest of product improvement, specifications are subject to change.

INDELECT

One East Commerce Drive
Schaumburg, IL 60173

800-55-OM

Cat . No. GC RLY6

INDIANA

885 Milner Avenue
Scarborough, Ontario M1B 5V8

416-286-6465

Specifications subject to change without notice.