

SPECIFICATIONS
 Current Rating: 1A AC,DC
 Voltage Rating: 125V AC,DC
 Temperature Range: -25°C ~ +85°C
 Contact Resistance: 20mΩ Max.
 Insulation Resistance: 100MΩ Min.
 Withstanding Voltage: 500V AC/minute
 Pin Material: Phosphor Bronze/Tin-plated
 Solder Tabs: Phosphor Bronze/Tin-plated
 Material: Nylon 6T,UL94V-0
 Color: Natural(Beige)

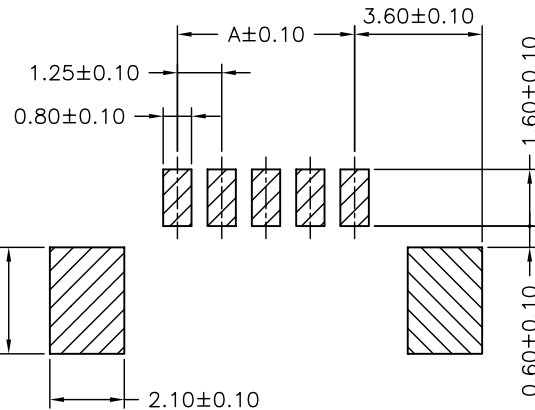

P.C.B LAYOUT

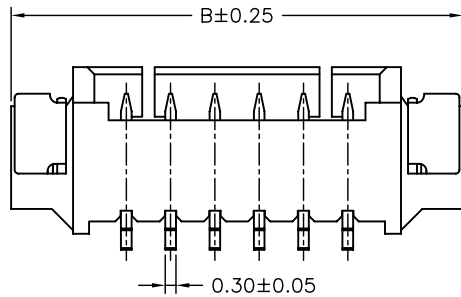
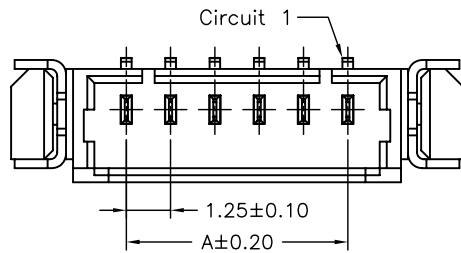
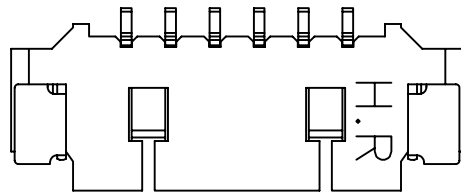
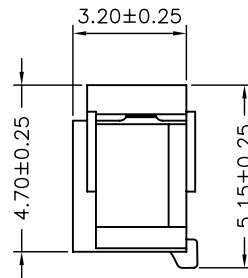

Ordering Information & Dimensions

PART NO.	Dimensions	
	A	B
A1250WR-S-02P	1.25	7.75
A1250WR-S-03P	2.50	9.00
A1250WR-S-04P	3.75	10.25
A1250WR-S-05P	5.00	11.50
A1250WR-S-06P	6.25	12.75
A1250WR-S-07P	7.50	14.00
A1250WR-S-08P	8.75	15.25
A1250WR-S-09P	10.00	16.50
A1250WR-S-10P	11.25	17.75
A1250WR-S-11P	12.50	19.00
A1250WR-S-12P	13.75	20.25
A1250WR-S-13P	15.00	21.50
A1250WR-S-14P	16.25	22.75
A1250WR-S-15P	17.50	24.00
A1250WR-S-16P	18.75	25.25
A1250WR-S-17P	20.00	26.50
A1250WR-S-18P	21.25	27.75

UNIT	SCALE	SHEET	TITLE:	
mm		1 of 3		
DRAWN BY	APPROVED BY		1.25mm PITCH 90° WAFER-SMT TYPE	
董正一	董正一			
2001.02.01	2001.02.01			
GENERAL TOLERANCE				
	X.X±0.25	ANGLE±		
B0	NEW RELEASE	2006.06.23	X.XX±0.15	
REV.	DESCRIPTION	DATE	X.XXX±0.05	
			DRAW NO. : A1250WR-S-XP	
			REV. B0	

02~08 Contacts

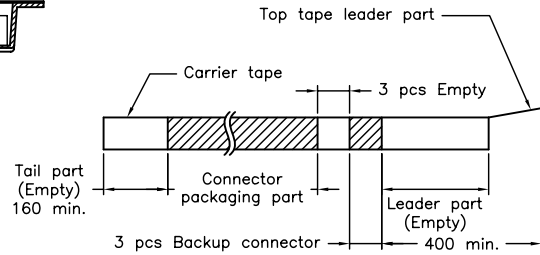
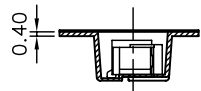
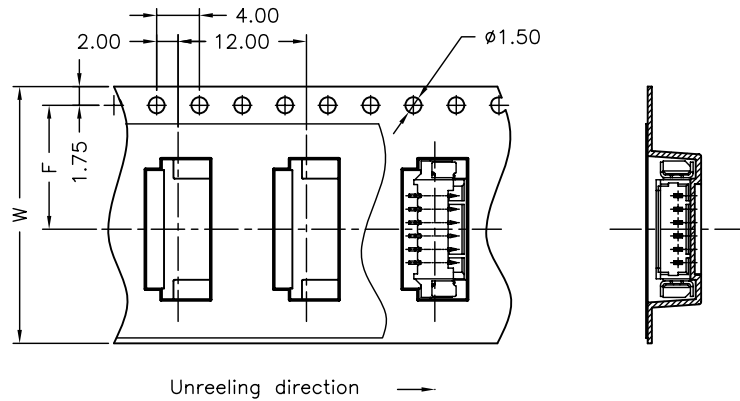

09~18 Contacts

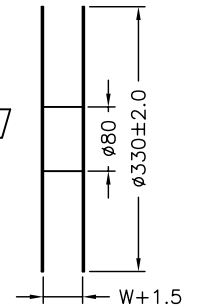
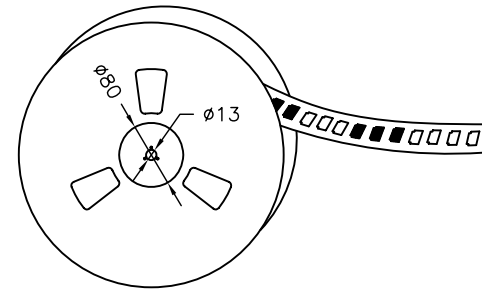
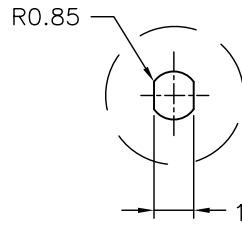
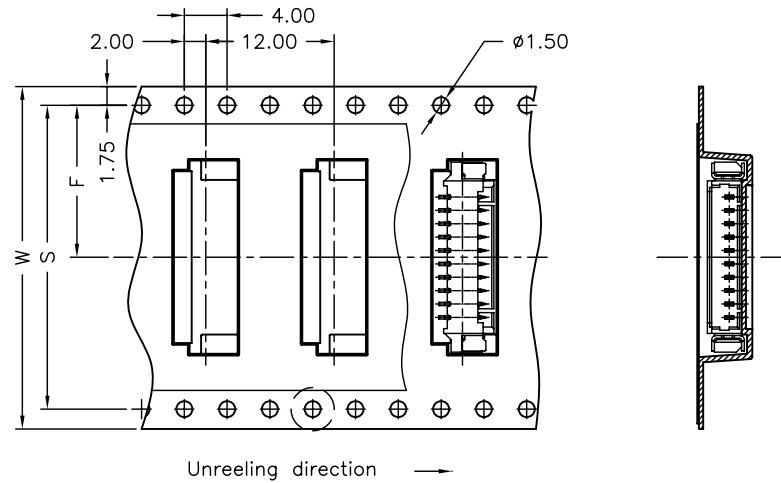

Number of Contacts	W±0.3	F±0.1	S±0.1	Q'ty/Reel
02P	16	7.50	/	1,000
03P	16	7.50		1,000
04P	24	11.50		1,000
05P	24	11.50		1,000
06P	24	11.50		1,000
07P	24	11.50		1,000
08P	24	11.50		1,000
09P	32	14.20		28.40
10P	32	14.20	28.40	1,000
11P	32	14.20	28.40	1,000
12P	32	14.20	28.40	1,000
13P	32	14.20	28.40	1,000
14P	44	20.20	40.40	1,000
15P	44	20.20	40.40	1,000
16P	44	20.20	40.40	1,000
17P	44	20.20	40.40	1,000
18P	44	20.20	40.40	1,000

UNIT		SCALE	SHEET		TITLE:
mm			2 of 3		1.25mm PITCH 90° WAFER-SMT TYPE TAPING SPEC.
DRAWN BY		APPROVED BY		DRAW NO. :	
蕭惠風		謝瑞清			
2004.02.12		2004.02.12			
GENERAL TOLERANCE					
X. X±0.25		ANGLE±			
X. XX±0.15		DATE			
X. XXX±0.05		DATE			
B0	NEW RELEASE	2006.06.23			
REV.	DESCRIPTION	DATE			