

BNC / BNC 75 HDTV / BNC-TRX series

R141 / R142 / R266

Pages

Introduction 10-4 to 10-5
 Interfaces 10-6 to 10-7
 Characteristics 10-8 to 10-11
 Finder guide 10-12 to 10-13

BNC 75 HDTV

Plugs 10-14
 Jacks 10-14
 Receptacles 10-15
 Adapters 10-15

BNC 50Ω

Plugs 10-16 to 10-17
 Jacks 10-17 to 10-19
 Receptacles 10-20 to 10-22
 Adapters 10-23 to 10-24
 Accessories 10-24
 Additional connectors 10-31

BNC 75Ω

Plugs 10-25 to 10-26
 Jacks 10-26 to 10-28
 Receptacles 10-28 to 10-29
 Adapters 10-30
 Additional connectors 10-31

BNC-TRX

Characteristics 10-32
 Plug 10-32
 Jack 10-32
 Receptacle 10-32

Panel drilling 10-33 to 10-34

INTRODUCTION



| | |
|-----|---|
| 50Ω | DC - 4 GHz DC - 1.5 GHz (commercial) DC - 1.0 GHz (Eco) DC - 10 GHz (TRIAxIAL) |
| 75Ω | DC - 1.5 GHz DC - 6 GHz (HDTV) DC - 1.0 GHz (Eco) |

GENERAL

- Worldwide standardised coaxial connectors
- Bayonet coupling
- Proven strength and reliability
- Good RF performance

APPLICABLE STANDARDS

- MIL-C-39012 / MIL STD 348-A/301
- IEC 169-8
- CECC 22120
- NF-C-93564 KBN series
- UTE-C-93564

APPLICATIONS

- Civil and military radio-telecommunication equipment
- Test and measurement
- Videocommunication
- Broadcast
- Industrial network
- General electronics

The BNC connector is the most popular coaxial connector series in the world, featuring a two-pin bayonet coupling system for quick and reliable engagement and disengagement.

• Wide range:

RADIALL's BNC connectors are available with two characteristic impedances: 50Ω and 75Ω. They are completely intermateable. RADIALL also offers low-cost- BNC range, and a triaxial BNC TRX series.

• Convenient three piece design:

Straight and right angle crimp type cable connectors feature a three piece design: single piece body + center contact + outer ferrule.



- **Fast and reliable cable attachment**

Cable connectors can be either fully crimped or soldered/crimped, offering full flexibility for fast, reliable, high-volume production with standard manual or pneumatic tooling.

- The center contact can be either crimped or soldered,
- The outer contact is attached to the cable by crimping a ferrule.

NEW: BNC 75 HDTV CONNECTOR SERIES WITH PERFORMANCE UP TO 6 GHz

Radiall's affordable "True" BNC 75 ohm HDTV Coaxial Connector Series can handle data rates up to 3 Gbps or higher, while supporting the broadcast industry's SMPTE 292M and 424M standards. Radiall is the only company that outperforms the rest with connectors that feature gold plated center and outer contacts. These provide outstanding electrical performance with a frequency range of up to 6 GHz, optimized at 3 GHz!

Features and Benefits

- Intermateable with standard 50 or 75 ohm BNC products
- Best material selection (brass, PTFE, BeCu, Gold) for outstanding performance and durability
- Better mechanical performance and durability with 1000 mating cycles guaranteed
- Field installable on most coaxial cables using hand-crimping tools
- Colored cable boots available for easy coding of video signals
- Custom made cable assemblies available

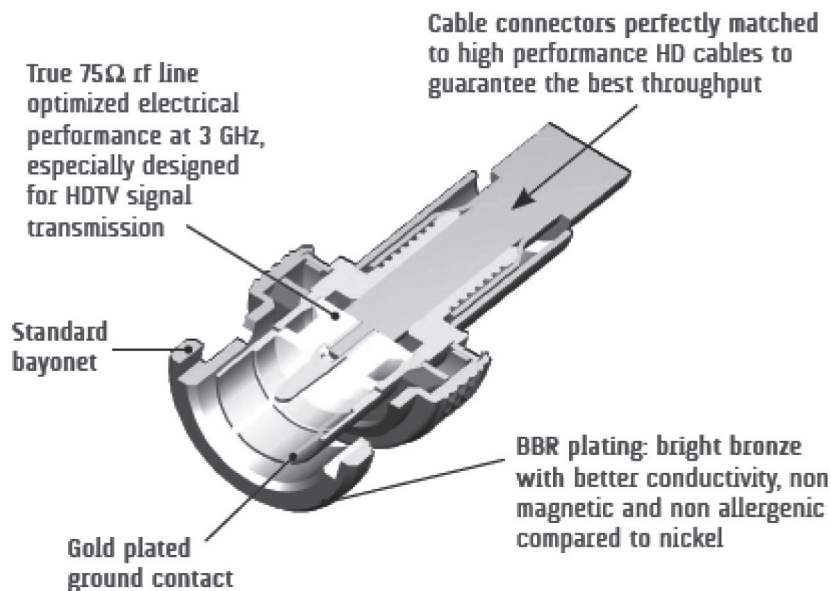

INTERFACE BNC 75 HDTV

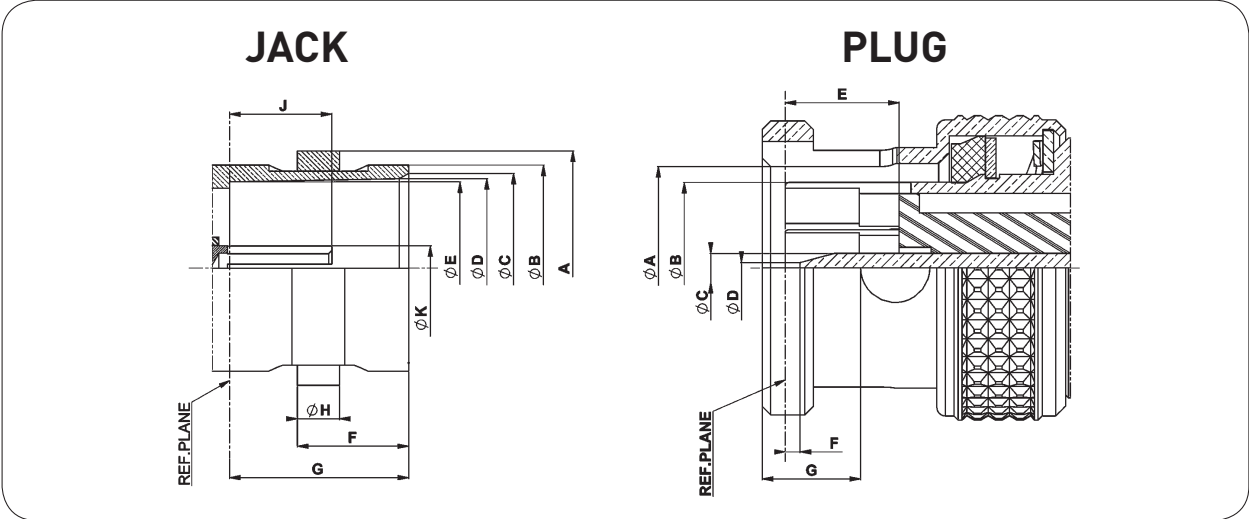

| Letter | mm | | inch | |
|--------|-------|-------|------|------|
| | min. | max. | min. | max. |
| A | 10.97 | 11.07 | .432 | .436 |
| B | 9.60 | 9.67 | .378 | .381 |
| C | 8.80 | 9.00 | .346 | .354 |
| D | 8.32 | 8.46 | .328 | .333 |
| E | 8.10 | 8.15 | .319 | .321 |
| F | 5.18 | 5.28 | .204 | .208 |
| G | 8.30 | 8.50 | .327 | .335 |
| H | 1.90 | 2.06 | .075 | .081 |
| J | 4.72 | 5.22 | .186 | .206 |
| K | 2.10 | 2.14 | .083 | .084 |

| Letter | mm | | inch | |
|--------|------|------|------|------|
| | min. | max. | min. | max. |
| A | 9.80 | 9.90 | .386 | .390 |
| B | 8.30 | 8.40 | .327 | .331 |
| C | 1.32 | 1.37 | .052 | .054 |
| D | 0.35 | 0.65 | .014 | .026 |
| E | 5.30 | 5.50 | .209 | .217 |
| F | 0.10 | 0.90 | .004 | .035 |
| G | 4.57 | 4.67 | .180 | .184 |

INTERFACE BNC 50Ω

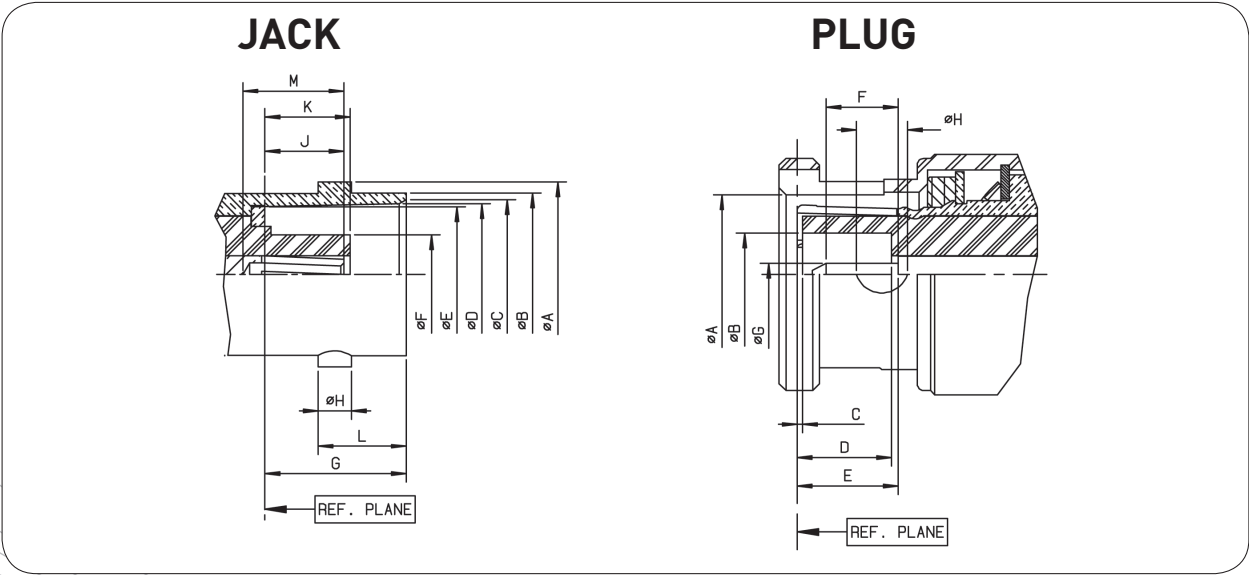

INTERFACE BNC 50Ω

| Letter | mm | | inch | |
|--------|-------|-------|------|------|
| | min. | max. | min. | max. |
| A DIA | 10.97 | 11.07 | .432 | .436 |
| B DIA | 9.60 | 9.70 | .378 | .382 |
| C DIA | 8.79 | 9.04 | .346 | .356 |
| D DIA | 8.31 | 8.46 | .327 | .333 |
| E DIA | 8.10 | 8.15 | .319 | .321 |
| F DIA | - | 4.72 | - | .186 |
| G | 8.31 | 8.51 | .327 | .335 |
| H | 1.91 | 2.06 | .075 | .081 |
| J | 4.72 | 5.23 | .186 | .206 |
| K | 4.78 | 5.28 | .188 | .208 |
| L | 5.18 | 5.28 | .204 | .208 |
| M | 4.95 | - | .195 | - |

| Letter | mm | | inch | |
|--------|------|------|------|------|
| | min. | max. | min. | max. |
| A DIA | 9.78 | 9.91 | .385 | .390 |
| B DIA | 4.83 | - | .190 | - |
| C | 0.15 | - | .006 | - |
| D | 5.28 | 5.79 | .208 | .228 |
| E | 5.33 | 5.84 | .210 | .230 |
| F | 1.98 | - | .078 | - |
| G DIA | 1.32 | 1.37 | .052 | .054 |
| H DIA | 2.31 | 2.46 | .091 | .097 |

BNC 50Ω/BNC 75Ω

INTERFACE BNC 75Ω

JACK

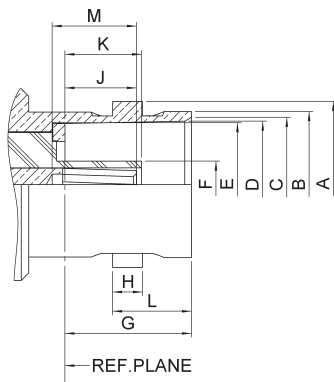

PLUG

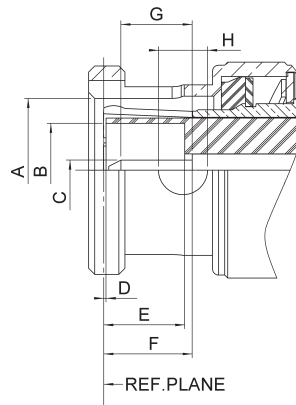

| Letter | mm | | inch | |
|--------|-------|-------|------|------|
| | min. | max. | min. | max. |
| A DIA | 10.97 | 11.07 | .432 | .436 |
| B DIA | 9.60 | 9.67 | .378 | .381 |
| C DIA | 8.80 | 9.00 | .347 | .354 |
| D DIA | 8.32 | 8.46 | .328 | .333 |
| E DIA | 8.10 | 8.15 | .319 | .321 |
| F DIA | 4.62 | 4.72 | .182 | .186 |
| G | 8.30 | 8.50 | .326 | .334 |
| H | 1.90 | 2.06 | .074 | .081 |
| J | 4.72 | 5.22 | .186 | .205 |
| K | 4.98 | 5.23 | .196 | .206 |
| L | 5.18 | 5.28 | .204 | .208 |
| M | 5.30 | 5.90 | .209 | .232 |

| Letter | mm | | inch | |
|--------|------|------|------|------|
| | min. | max. | min. | max. |
| A DIA | 9.80 | 9.90 | .386 | .389 |
| B DIA | 6.10 | 6.30 | .240 | .248 |
| C DIA | 1.32 | 1.37 | .052 | .054 |
| D | 0.05 | - | .002 | - |
| E | 5.42 | 5.78 | .213 | .227 |
| F | 5.35 | 5.87 | .211 | .231 |
| G | 3.00 | 3.40 | .118 | .134 |
| H DIA | 3.15 | 3.35 | .124 | .132 |

CHARACTERISTICS

ELECTRICAL CHARACTERISTICS

| | | | |
|---------------------------------|---------------------------------|-------------|-----------|
| Frequency range | DC - 6 GHz (optimized at 3 GHz) | | |
| Impedance | 75Ω | | |
| V.S.W.R. (max) | DC - 1.5 GHz | 1.5 - 3 GHz | 3 - 6 GHz |
| Interface (plug + jack) | 1.02 | 1.05 | 1.08 |
| Mated pair | 1.05 | 1.12 | 1.25 |
| In series adapters | 1.04 | 1.07 | 1.12 |
| Working voltage | 500 Vrms | | |
| Dielectric withstanding voltage | 1500 Vrms | | |
| RF Leakage @ 1 GHz | 75 dB | | |
| RF Leakage @ 3 GHz | 60 dB | | |
| RF Leakage @ 6 GHz | 50 dB | | |

MECHANICAL CHARACTERISTICS

| | |
|---------------------------------------|--|
| Mating | Intermateable with 50Ω and 75Ω standard BNC connectors |
| Long life duration (mating endurance) | 1000 cycles |
| Engagement force | 13.6 N |
| Mating torque (bayonet) | 28.6 N.cm |
| Coupling nut retention force | Axial force: 450 N Bending stress: 1000 N.cm |
| Center contact insertion force | 10 N max |
| Vibration | MIL STD 202 Meth.204 cond B |

ENVIRONMENTAL CHARACTERISTICS

| | |
|----------------------|--|
| Temperature range | -65°C + 165°C |
| Moisture resistance | MIL STD 202, Meth. 106 CECC 22000 paragraph 4.6.6 |
| Corrosion resistance | MIL STD 202, Meth. 101 cond B (48 hours salt spray) |

MATERIALS and PLATING

| Components | Materials | Platings |
|----------------|---------------------------|-----------------|
| Body | Brass | NPGR/BBR/Nickel |
| Center contact | Brass or Beryllium copper | NPGR |
| Outer contact | Brass | NPGR |
| Insulator | PTFE | |
| Gasket | Silicone Rubber | |

| Test/characteristics | Standard reference | Values/remarks |
|----------------------|--------------------|----------------|
|----------------------|--------------------|----------------|

ELECTRICAL CHARACTERISTICS

| Impedance | | 50Ω | | |
|--|------------------------------|----------------------------|------------------|-------|
| Frequency range | | DC - 4 GHz | | |
| Typical V.S.W.R. straight models cable groupe: 2/50, 2.6/50, 5/50, 10 + 11/50, .141" right angle models: 2/50, 2.6/50, 5/50 | | 1 GHz | 2.5 GHz | 4 GHz |
| | | 1.12 | 1.18 1.30 max | 1.22 |
| Insertion loss | straight connector | 0.05 | 0.07 | 0.13 |
| | right-angle connector | 0.08 | 0.16 | 0.20 |
| RF leakage | | -55 dB min from 2 to 3 GHz | | |
| Insulation resistance | | 5000 MΩ min | | |
| Contact resistance | center contact | 1.5 mΩ | | |
| | outer contact | 0.2 mΩ | | |
| Working voltage in VRMS | at sea level (at 21 000m) | 500 | | |
| | | 125 | | |
| Dielectric withstanding voltage in VRMS | at sea level (at 21 000m) | 1500 | | |
| | | 375 | | |
| RF testing voltage in VRMS | sea level (5 MHz) | 1000 | | |

MECHANICAL CHARACTERISTICS

| | | |
|--------------------------------|---|-------------|
| Durability | | 500 matings |
| Force to engage and disengage | axial torque | 13.6 N max |
| | | 28.6 Ncm |
| Coupling nut retention force | | 445 N |
| Cable retention force | cable 2/50, 2.6/50 cable 5/50, 10 + 11/50 cable .141" | 227 N |
| | | 27.2 N |
| Center contact retention force | | 27.2 N |

ENVIRONMENTAL CHARACTERISTICS

| | | |
|----------------------------|--------------------------------------|--|
| Temperature range | flexible cables semi-rigid cables | -65°C + 165°C -65°C + 105°C |
| Thermo cycling test | | MIL STD 202, method 107, condition B |
| Thermal shock | | MIL STD 202, method 107, condition B |
| High temperature endurance | | MIL STD 202, method 108 |
| Corrosion salt spray | | MIL STD 202, method 101, condition B |
| Vibration | | MIL STD 202, method 204, condition B |
| Shock | | MIL STD 202, method 213, condition G |
| Moisture resistance | | MIL STD 202, method 106 |
| Hermetic test | | MIL STD 202, method 112, condition C vacuum 10 ⁻⁶ Hgmm (Torr) leakage rate < 10 ⁻⁶ atm/cm ³ /s |
| Barometric pressure | | Pressure test: 3.5 bars; duration: 2 mn; temperature: 15°C to 25°C |

MATERIALS AND PLATING

| | Materials | Platings |
|----------------|---|--------------|
| Bodies | Brass | Nickel / BBR |
| Center contact | Brass | Gold |
| | Bronze or heat treated beryllium following QQ-C-530 | |
| Nut | Brass | |
| Insulator | PTFE | |
| Gasket | Silicon Rubber | |

All dimensions are given in mm.

CHARACTERISTICS

| Test/characteristics | Standard reference | Values/remarks |
|----------------------|--------------------|----------------|
|----------------------|--------------------|----------------|

ELECTRICAL CHARACTERISTICS

| | | |
|--|-----|--|
| Impedance | | 75Ω |
| Frequency range | | DC - 1.5 GHz |
| V.S.W.R. max straight models cable group: 2.6/75, 5/75, 6/75, 8/75, 10 + 11/75 right angle models: 2.6/75, 6/75 | | 1.30 1.35 |
| Insertion loss straight connector right-angle connector | MIL | 0.2 dB max at 1 GHz 0.3 dB max at 1 GHz |
| RF leakage | | -55 dB min from 2 to 3 GHz |
| Insulation resistance | | 5000 MΩ min |
| Contact resistance center contact outer contact | | 1.5 mΩ 0.2 mΩ |
| Working voltage in VRMS at sea level (at 21 000m) | | 500 125 |
| Dielectric withstanding voltage in VRMS at sea level (at 21 000m) | | 1500 |
| | | 375 |
| RF testing voltage in VRMS sea level (5 MHz) | | 1000 |

MECHANICAL CHARACTERISTICS

| | | |
|---|-----|------------------------|
| Durability | MIL | 500 matings |
| Force to engage and disengage axial torque | | 13.6 N max 28.6 Ncm |
| Coupling nut retention force | | 445 N |
| Cable retention force cable 2.6/75, 5/75 6/75, 8/75, 10 + 11/75 | | 340 N |
| Center contact retention force | | 27 N |

ENVIRONMENTAL CHARACTERISTICS

| | | |
|--------------------------------------|-----|--|
| Temperature range flexible cables | MIL | -65°C + 165°C |
| Thermo cycling test | | MIL STD 202, method 107, condition B |
| High temperature endurance | | MIL STD 202, method 108 |
| Corrosion salt spray | | MIL STD 202, method 101, condition B |
| Vibration | | MIL STD 202, method 204, condition B |
| Shock | | MIL STD 202, method 213, condition G |
| Moisture resistance | | MIL STD 202, method 106 |
| Hermetic test | | MIL STD 202, method 112, condition C vacuum 10 ⁻⁶ Hgmm (Torr) leakage rate < 10 ⁻⁶ atm/cm ² /s |
| Barometric pressure | | Pressure test: 3.5 bars; duration: 2 mn; temperature: 15°C to 25°C |

MATERIALS AND PLATING

| | Materials | Platings |
|----------------------------------|--|----------|
| Bodies | Brass | Nickel |
| Center contact male female | Brass Bronze or heat treated beryllium following QQ-C-530 | Gold |
| Nut | Brass | |
| Insulator | PTFE | |
| Gasket | Silicone Rubber | |

Standard packaging = 100 pieces.

COMMERCIAL VERSION R141 XXX 161 and R142 XXX 161

ELECTRICAL CHARACTERISTICS

| | R141 XXX 161 | R142 XXX 161 |
|----------------------------|---------------|--------------|
| Impedance | 50Ω | 75Ω |
| Operating frequency | DC to 1.5 GHz | |
| Typical V.S.W.R. (1.5 GHz) | | |
| straight models | ∅ 2.6 | 1.21 |
| | ∅ 5 | 1.14 |
| | ∅ 6 | 1.05 |
| right angle models | ∅ 5 & ∅ 6 | 1.17 |
| Testing voltage (VRMS) | 1500 | |
| Operating voltage (VRMS) | 500 | |
| Insulation resistance (MΩ) | 5000 | |
| Contact resistance (mΩ) | 10 | |

MECHANICAL CHARACTERISTICS

| | |
|------------|-------------|
| Durability | 100 matings |
|------------|-------------|

ENVIRONMENTAL CHARACTERISTICS

| | |
|-------------------|--------------|
| Temperature range | -40°C + 85°C |
|-------------------|--------------|

MATERIALS AND PLATING

| | Materials | Platings |
|---------------------------------|---------------|----------|
| Male and female bodies | Brass | Nickel |
| Coupling nut | Die cast zinc | |
| Outer contact | Brass | |
| Insulators | Polypropylene | |
| Male and female center contacts | Brass | Gold |

ECO VERSION R141A XXX XXX and R142A XXX XXX

ELECTRICAL CHARACTERISTICS

| | R141A XXX XXX | R142A XXX XXX |
|------------------------------------|-------------------|---------------|
| Impedance | 50Ω | 75Ω |
| Frequency range | DC - 1 GHz | |
| Typical V.S.W.R. (straight models) | 1.3 at 1 GHz | |
| Temperature range | -40°C / +85°C | |
| Durability | 100 mating cycles | |

MATERIALS AND PLATING

| | Materials | Platings |
|------------------------|---------------------|-------------------------------------|
| Connector body | Brass/Die cast zinc | Nickel |
| Insulators | PTFE/Polypropylene | |
| Female center contacts | Phosphor bronze | Gold 0.1μm typical (Center contact) |

PACKAGING/MOQ

| | |
|---------------|--|
| Packaging/MOQ | 100 pieces bulk/MOQ 1000 pieces Unit packaging/MOQ 100 pieces |
|---------------|--|

Standard packaging = 100 pieces.

All dimensions are given in mm.

FINDER GUIDE

CABLE CONNECTORS

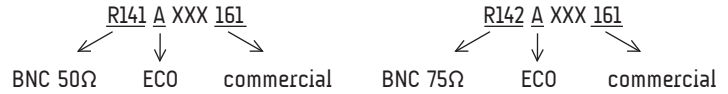

| Model | Straight plug | | Right-angle plug | | Straight jack | | Square flange straight jack | | Bulkhead straight jack | |
|-------------------|---|--|--|--------------|------------------------------|--------------|-----------------------------|--|---|--|
| | Crimp and full crimp | Clamp | Crimp and full crimp | Clamp | Crimp and full crimp | Clamp | Crimp and full crimp | Clamp | Crimp and full crimp | Clamp |
| 2/50/S (RG178) | R141 070 520 | R141 003 000 | | | | | | R141 253 000 | R141 301 000 | R141 323 000 |
| 2.6/50/S (RG316) | R141 075 000 R141 075 161 R141A 075 161 | R141 004 000 | R141 181 161 | R141 154 000 | R141 217 000 | | | R141 254 000 R141 277 000 R141 278 000 | R141 306 000 R141 306 503 R141 331 500 R141A 306 000 R141 331 500 | R141 304 000 R141 324 000 R141 324 200 |
| 2.6/50/D (RD316) | | R141 004 000 | | R141 154 000 | | | | R141 254 000 R141 277 000 R141 278 000 | | |
| 2.6/75/S (RG179) | R142 076 000 R142 076 161 R142A 076 161 | R142 004 000 | | R142 154 000 | R142 217 000 | | | R142 202 000 | R142 306 500 R142 306 503 R142 331 011 R142A 306 500 | |
| 3.6/75/D (BT3002) | R142A 081 130 | | | | | | | | R142A 325 106 | |
| 5/50/S (RG58) | R141 072 000 R141 082 000 R141 082 161 R141A 082 161 | R141 007 161 R141 008 000 R141 009 000 R141 010 000 | R141 182 000 R141 182 161 R141 182 177 | R141 156 000 | R141 237 000 R141 237 161 | R141 207 000 | R141 292 000 | R141 256 000 R141 258 000 | R141 308 000 R141 332 161 R141 332 500 R141A 332 161 | R141 327 000 |
| 5/50/D (RG142) | R141 083 000 R141 097 000 R141A 083 000 | R141 008 000 R141 009 000 R141 010 000 | R141 183 000 | R141 156 000 | R141 220 000 | R141 207 000 | R141 297 000 | R141 258 000 | | R141 327 000 |
| 5/75/D | R142 083 000 | | | | | | | | | |
| 6/75/S (RG59) | R142 085 000 R142 085 161 R142 085 165 R142A 085 161 | R142 016 000 R142 016 161 | R142 184 000 R142 184 161 | R142 157 000 | R142 242 000 R142 242 161 | | | R142 268 000 | R142 334 161 R142A 334 161 | R142 329 000 |
| 8.07/50 | R141 097 190 | | | | | | R141 296 190 | | | |
| 8/75/S | | R142 017 000 | | | | | | | | |
| 10 + 11/50 | | R142 018 000 | | | | | | | | |
| 10 + 11/75 | R141 095 000 | R142 018 000 | | | | | | | | |
| 141" (RG402) | | R141 052 000 | | | | | | | | R141 338 007 |

CAPS

| Model | Free | Cord | Chain | Short-circuit chain |
|--------|--------------|--------------|--------------|---------------------|
| Male | R141 802 000 | R141 805 000 | R141 812 000 | R141 862 000 |
| Female | | | R141 842 000 | |

RECEPTACLES

| Model | Straight female flange | | Right-angle female flange | Straight female bulkhead | | Straight male flange | Straight male bulkhead | Press mount receptacles | PCB receptacles | | | |
|--------------------------------|------------------------|--|---------------------------|------------------------------|---|----------------------|------------------------|------------------------------|--|------------------------------|---------------|--|
| | Cable | Square | 2 hole | Square | Front mount | Right angle | Square | Front mount | Straight | Straight | Right angle | Bulkhead right angle |
| Solder contact with Solder pot | | R141 403 000 R141 404 000 R141 406 000 R141 407 000 R141 410 000 R142 412 000 | R141 453 000 | R141 653 000 R141 654 000 | R141 554 000 R141 554 161 R141 557 000 R141 559 000 R141 563 161 R141 572 000 R141 574 000 R141 574 161 R141 603 000 R141 605 000 R141 625 000 R142 562 000 R141A 605 000 | R141 680 000 | R141 440 000 | R141 580 000 R142 580 000 | | | | |
| Solder cylindrical contact | | | | | | | | R141 500 200 | | | | |
| Solder pins (standard space) | | | | | | | | | R141 426 000 R141 426 161 R142 426 020 R142 426 261 | R141 665 000 R141 665 200 | R141A 676 121 | |
| Solder pins (reduced space) | | | | | | | | | R141 508 200 R142 500 230 | | | |
| Press fit pins | | | | | | | | | | | | R141 684 130 R142 676 430 R142 684 130 |

IN-SERIES ADAPTERS

| Model | Straight | Straight bulkhead | Straight flange | Right-angle | Tree | Cross |
|-----------|------------------------------|--|--|------------------------------|--|--------------|
| M-M | R141 703 000 R142 703 000 | | | | | |
| F-F | R141 704 000 R142 704 000 | R141 720 000 R141 723 000 R141 723 161 R142 730 000 R141 753 000 R142 720 000 R142 723 000 R141A 720 000 R142A 720 000 | R141 710 000 R141 717 000 R142 710 000 | | | |
| M-F | | | | R141 770 000 R142 770 000 | | |
| F-F / M | | | | | R141 780 000 R141 789 000 R142 780 000 R142 789 000 | |
| F-F / F | | | | | R141 782 000 R142 782 000 | |
| M-F-F / F | | | | | | R141 799 000 |

PLUGS AND JACKS

STRAIGHT PLUGS CRIMP TYPE FOR FLEXIBLE CABLES

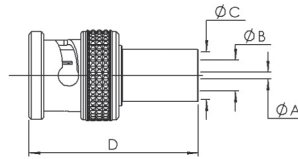

| Cable group | Cable group dia. | Part number | Dimensions mm (inch) | | | | Packaging | Note |
|---|------------------|---------------------|----------------------|------------|--------------|--------------|-----------|--------------------------------|
| | | | A | B | C | D | | |
| Belden 1855A, Draka 0.6/2.8 AF, CAE HD 0628 | 0.6/2.8 | R142 077 702 | 0.85 (.03) | 2.85 (.11) | 5.42 (.21) | 27.68 (1.09) | 100 | |
| Argosy Image 360 | 0.6/2.95 | R142 077 712 | | 3.00 (.12) | | | | |
| Belden 1505A, Draka 0.8/3.7 AF, CAE HD 08370, Argosy Image 720 | 0.8/3.7 | R142 077 722 | 3.75 (.15) | 6.60 (.26) | 26.68 (1.05) | | | |
| | | R142 085 702 | 0.90 | 3.95 | 6.60 | 28.68 | | Hexagonal crimp tool 1.73/6.48 |
| Belden 1694A, Draka 1.0/4.8 AF, CAE HD 10460, Argosy Image 1000 | 1.0/4.8 | R142 077 732 | 1.05 (.04) | 4.85 (.19) | 7.50 (.30) | 26.68 (1.05) | | |
| Belden 7731, Draka 1.6/7.3 AF, CAE HD16720, Argosy Image 2000 | 1.6/7.3 | R142 077 747 | 1.70 | 7.45 | 11.05 | 32 | | |

RIGHT ANGLE PLUG CRIMP TYPE FOR FLEXIBLE CABLE

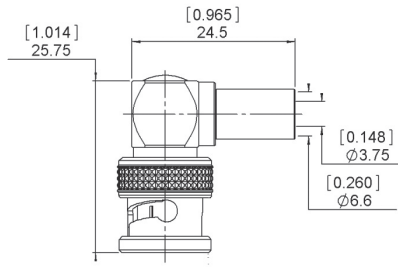

| Cable group | Cable group dia. | Part number | Packaging |
|--|------------------|---------------------|-----------|
| Belden 1505A, Draka 0.8/3.7 AF, CAE HD 08370, Argosy Image 720 | 0.8/3.7 | R142 187 720 | 100 |

STRAIGHT BULKHEAD JACK CRIMP TYPE FOR FLEXIBLE CABLE

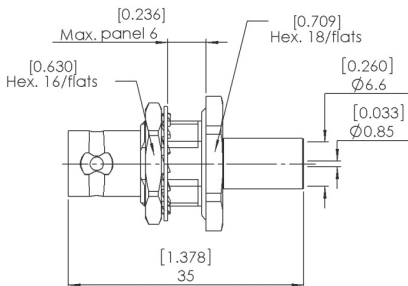

| Cable group | Cable group dia. | Part number | Panel drilling | Packaging |
|--|------------------|---------------------|----------------|-----------|
| Belden 1505A, Draka 0.8/3.7 AF, CAE HD 08370, Argosy Image 720 | 0.8/3.7 | R142 334 700 | P20 | 100 |

PCB FEMALE RECEPTACLES

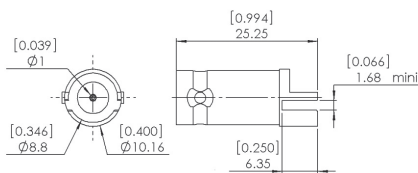
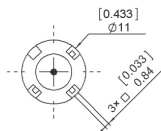
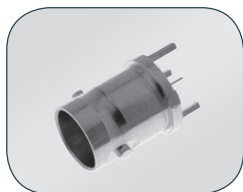

Fig. 2

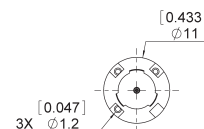

Fig. 4

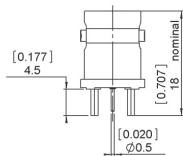

Fig. 1

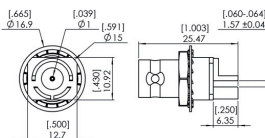
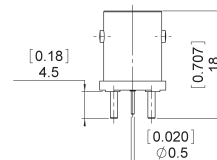
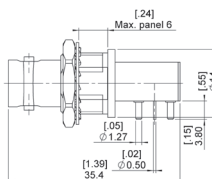
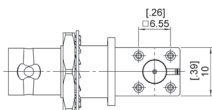
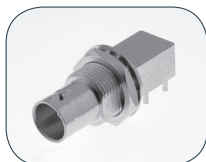

Fig. 3



| Part number | Fig. | Captive center contact | Panel drilling | Packaging | Note |
|--------------|------|------------------------|----------------|-----------|-------------------------|
| R142 500 730 | 1 | yes | P28 | 100 | Straight PCB |
| R142 568 703 | 2 | | | 100 | Edge mount PCB |
| R142 567 703 | 3 | | | | Bulkhead Edge mount PCB |
| R142 500 740 | 4 | | P27 | 60 | Straight PCB, Zamak |

RIGHT ANGLE PCB FEMALE RECEPTACLES



| Part number | Captive center contact | Note |
|--------------|------------------------|----------|
| R142 676 700 | yes | Bulkhead |

IN SERIES ADAPTERS

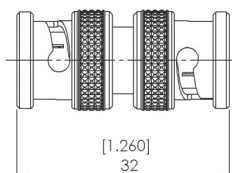

Fig. 1

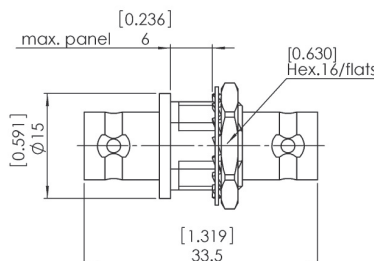

Fig. 2

| Part number | Fig. | Captive center contact | Panel drilling | Note | Packaging |
|--------------|------|------------------------|----------------|---------------|-----------|
| R142 703 703 | 1 | yes | P20 | Male-male | 100 |
| R142 720 700 | 2 | | | Female-female | |

BETWEEN SERIES ADAPTERS

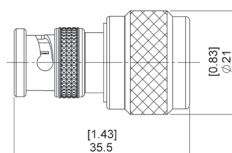

Fig. 1

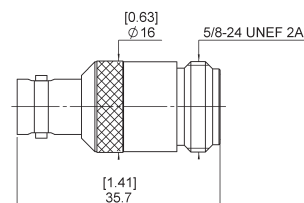

Fig. 2

| Part number | Fig. | Captive center contact | Note |
|--------------|------|------------------------|--------------------------|
| R192 417 010 | 1 | yes | BNC HD male - N male |
| R192 418 010 | 2 | | BNC HD female - N female |

To download data sheets and assembly instructions, visit www.radiall.com & enter the part number in the Search box. Bold part numbers represent products typically in stock & available for immediate shipment. See page 8 and 9 for packaging information.

STRAIGHT PLUGS

STRAIGHT PLUGS CLAMP TYPE

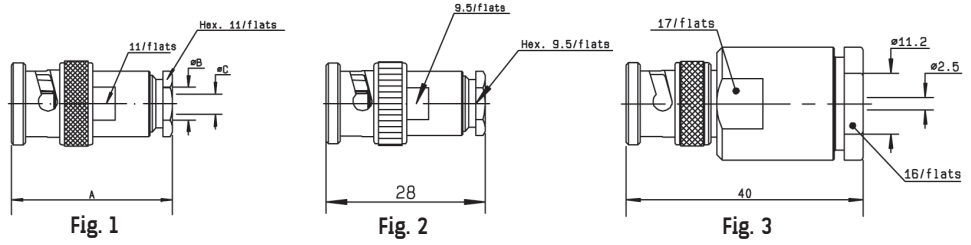

| Cable group | Cable group dia. | Part number | Fig. | Dimensions (mm) | | | Captive center contact | Note |
|------------------------------|------------------|---------------------|------|-----------------|------|------|------------------------|--------------------|
| | | | | A | B | C | | |
| RG178/RG196 | 2/50/S + D | R141 003 000 | 1 | 27 | 2.2 | 0.6 | yes | |
| RG174/RG316/RD316 | 2.6/50/S + D | R141 004 000 | | | 3.1 | | | |
| RG58/RG141 | 5/50/S | R141 007 161 | 2 | | | | no | Commercial version |
| RG58/RG141/RG142/RG223/RG400 | 5/50/S + D | R141 008 000 | 1 | 28 | 5.6 | 1.2 | no | |
| | | R141 009 000 | 1 | 28 | 5.6 | 1.2 | no | |
| | | R141 010 000 | | | | 1.05 | yes | |
| RG213/RG393/RG214/RG216 | 10 + 11/50/S + D | R141 018 000 | 3 | | | | | |
| RG402 | .141" | R141 052 000 | 1 | 29 | 3.65 | 1.2 | no | Semi-rigid cable |

STRAIGHT PLUGS FULL CRIMP TYPE FOR FLEXIBLE CABLES

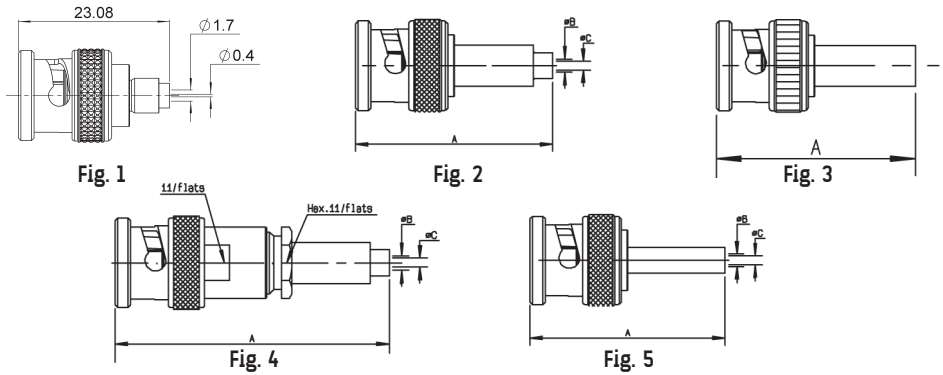

| Cable group | Cable group dia. | Part number | Fig. | Dimensions (mm) | | | Captive center contact | Note |
|-------------------|------------------|----------------------|------|-----------------|-----|------|------------------------|---|
| | | | | A | B | C | | |
| RG178/RG196 | 2/50/S | R141 070 520 | 1 | 23 | 1.7 | 0.4 | yes | Reverse crimp |
| RG174/RG316 | 2.6/50/S | R141 075 000 | 2 | 31 | 1.8 | 0.6 | yes | Commercial version |
| | | R141 075 161 | 3 | 30.3 | | | | |
| | | R141A 075 161 | 3 | 26 | 1.7 | 0.6 | yes | Not full crimp/ Single piece body ECO version |
| | 3.55/50/S | R141 095 020 | 4 | 43 | 2.6 | 1.05 | yes | |
| RG58/RG14 | 5/50/S | R141 072 000 | 4 | 39 | 3.1 | | yes | Single piece body |
| | | R141 082 000 | 5 | | | | | |
| | | R141 082 161 | 3 | 28 | | | yes | Single piece body Commercial version |
| | | R141A 082 161 | 3 | 30 | 3.1 | 1 | yes | ECO version |
| RG142/RG223/RG400 | 5/50/D | R141 083 000 | 5 | 28 | 3 | 1.05 | yes | Single piece body |
| | | R141A 083 000 | 2 | 30 | 3.1 | 1.2 | no | ECO version |
| | | R141 097 000 | 4 | 43 | 3 | 1.05 | yes | |
| | 8.07/50 | R141 097 190 | 4 | 50 | 6.3 | 2.5 | yes | |

For other types of cables (75Ω, 93Ω or BT cables), please see "additional connectors" on page 10-32. To download data sheets and assembly instructions, visit www.radiall.com & enter the part number in the Search box. **Bold** part numbers represent products typically in stock & available for immediate shipment. See page 8 and 9 for packaging information.

RIGHT ANGLE PLUGS AND STRAIGHT JACKS

BNC 50Ω

RIGHT ANGLE PLUGS CLAMP TYPE FOR FLEXIBLE CABLES

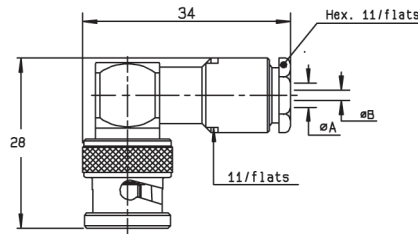

Fig. 1

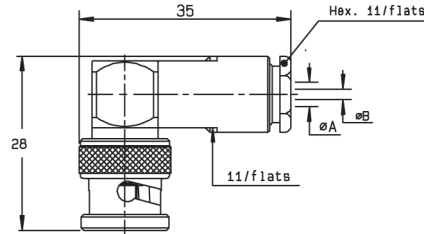

Fig. 2

| Cable group | Cable group dia. | Part number | Fig. | Dimensions (mm) | | Captive center contact | Note |
|------------------------------|------------------|---------------------|------|-----------------|------|------------------------|----------------|
| | | | | A | B | | |
| RG174/RG316/RD316 | 2.6/50/S + D | R141 154 000 | 1 | 3.1 | 0.6 | yes | 100 pieces |
| RG58/RG141/RG142/RG223/RG400 | 5/50/S + D | R141 156 000 | 2 | 5.6 | 1.05 | | Unit packaging |

RIGHT ANGLE PLUGS FULL CRIMP TYPE FOR FLEXIBLE CABLES

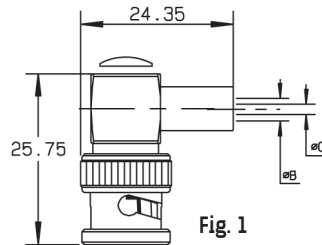

Fig. 1

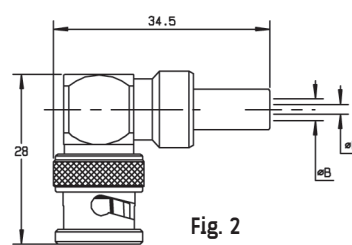

Fig. 2

| Cable group | Cable group dia. | Part number | Fig. | Dimensions (mm) | | Captive center contact | Note |
|-------------------|------------------|---------------------|------|-----------------|------|------------------------|--------------------|
| | | | | B | C | | |
| RG174/RG316 | 2.6/50/S | R141 181 161 | 1 | 3.25 | 1.7 | yes | Commercial version |
| RG58/RG141 | 5/50/S | R141 182 000 | 2 | 5.5 | 1.05 | | Single piece body |
| | | R141 182 161 | 1 | 5.5 | 3.15 | | Commercial version |
| | | R141 182 177 | 2 | 5.55 | 3.2 | | Non magnetic |
| RG142/RG223/RG400 | 5/50/D | R141 183 000 | 2 | 5.8 | 1.05 | | Single piece body |

STRAIGHT JACKS FOR FLEXIBLE CABLES

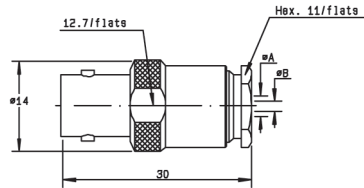

Fig. 1

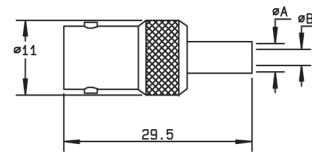

Fig. 2

| Cable group | Cable group dia. | Part number | Fig. | Dimensions (mm) | | Captive center contact | Note |
|------------------------------|------------------|---------------------|------|-----------------|------|------------------------|-------------------------------------|
| | | | | A | B | | |
| RG58/RG141/RG142/RG223/RG400 | 5/50/S + D | R141 207 000 | 1 | 5.6 | 1.05 | no | Clamp type |
| RG174/RG316 | 2.6/50/S | R141 217 000 | 2 | | 0.57 | yes | Full crimp type |
| RG58/RG141 | 5/50/S | R141 237 000 | 2 | 5.5 | 1.05 | yes | Single piece body, full crimp type |
| | | R141 237 161 | 2 | | | | Commercial version, full crimp type |
| RG142/RG223/RG400 | 5/50/D | R141 220 000 | 2 | | | | |

For other types of cables (75Ω, 93Ω or BT cables), please see "additional connectors" on page 10-32.
 To download data sheets and assembly instructions, visit www.radiall.com & enter the part number in the Search box.
Bold part numbers represent products typically in stock & available for immediate shipment.
 See page 8 and 9 for packaging information.

SQUARE FLANGE JACKS

STRAIGHT SQUARE FLANGE JACKS CLAMP TYPE FOR FLEXIBLE CABLES

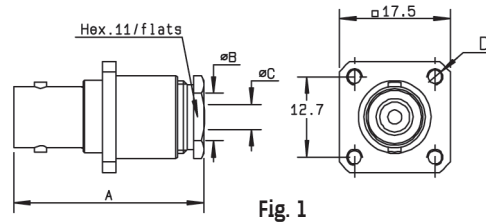
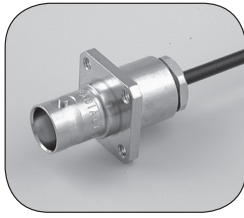

Fig. 1

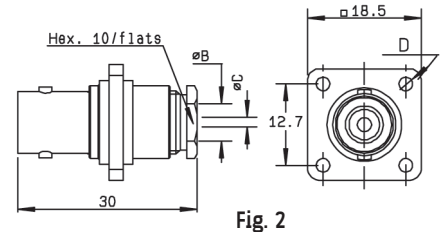

Fig. 2

| Cable group | Cable group dia. | Part number | Fig. | Dimensions (mm) | | | | Captive center contact | Panel drilling | Note |
|------------------------------|------------------|--------------|------|-----------------|-----|------|-------------|------------------------|----------------|------------------|
| | | | | A | B | C | D | | | |
| RG178/RG196 | 2/50/S + D | R141 253 000 | 1 | 29.5 | 2.2 | 0.6 | 3-56-UNF-2B | yes | P01 | |
| RG174/RG316/RD316 | 2.6/50/S + D | R141 254 000 | | | 3.1 | | | | | |
| | | R141 278 000 | | | 2 | | | | | 3 |
| RG58/RG141 | 5/50/S | R141 256 000 | 2 | | 5.6 | 1.05 | 2.6 | no | P02 | Insulated flange |
| RG58/RG141/RG142/RG223/RG400 | 5/50/S + D | R141 258 000 | 1 | 30 | 5.6 | 1.05 | 3-56-UNF-2B | | P02 | Unit packaging |

STRAIGHT SQUARE FLANGE JACKS FULL CRIMP TYPE FOR FLEXIBLE CABLES

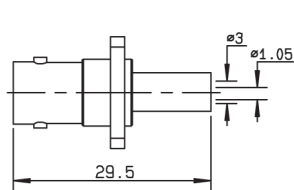

Fig. 1

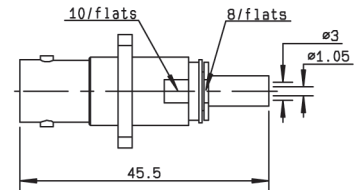

Fig. 2

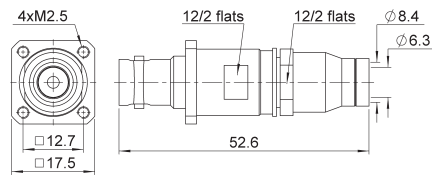

Fig. 3

| Cable group | Cable group dia. | Part number | Fig. | Dimensions D (mm) | Captive center contact | Panel drilling | Note |
|-------------------|------------------|--------------|------|-------------------|------------------------|----------------|-------------------|
| RG58/RG141 | 5/50/S | R141 292 000 | 1 | 3 x 56 UNEF 2B | yes | P23 | Single piece body |
| RG142/RG223/RG400 | 5/50/D | R141 297 000 | 2 | M2.5 x 0.45 | | | |
| | 8.07/50 | R141 296 190 | 3 | M2.5 x 0.45 | | | P13 |

For other types of cables (75Ω, 93Ω or BT cables), please see "additional connectors" on page 10-32.

To download data sheets and assembly instructions, visit www.radiall.com & enter the part number in the Search box.

Bold part numbers represent products typically in stock & available for immediate shipment.

See page 8 and 9 for packaging information.

STRAIGHT BULKHEAD JACKS CLAMP TYPE

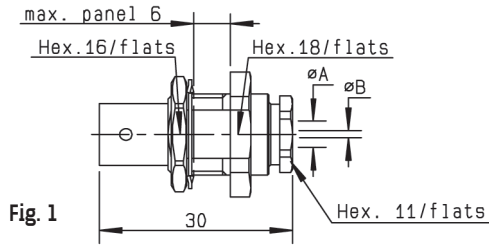

Fig. 1

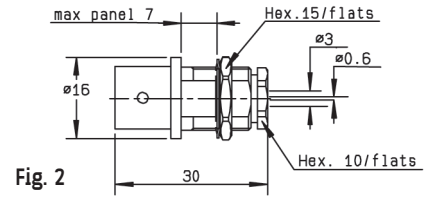

Fig. 2

| Cable group | Cable group dia. | Part number | Fig. | Dimensions (mm) | | Captive center contact | Panel drilling | Note |
|------------------------------|------------------|---------------------|------|-----------------|------|------------------------|----------------|----------------------------|
| | | | | A | B | | | |
| RG178/RG196 | 2/50/S | R141 323 000 | 1 | 2.2 | 0.6 | yes | P14 | Panel sealed |
| RG174/RG316 | 2.6/50/S | R141 304 000 | 2 | | | | | Totally sealed |
| | | R141 324 000 | 1 | 3.1 | 0.6 | Panel sealed | | |
| RG174/RG316/RD316 | 2.6/50/S + D | R141 324 200 | 1 | 3.1 | 0.6 | yes | | Panel sealed |
| RG58/RG141/RG142/RG223/RG400 | 5/50/S + D | R141 327 000 | 1 | 5.6 | 1.05 | no | | |
| RG401 | .141" | R141 338 007 | 1 | 3.68 | 1.27 | yes | | Panel sealed, non magnetic |

STRAIGHT BULKHEAD JACKS CRIMP TYPE FOR FLEXIBLE CABLES

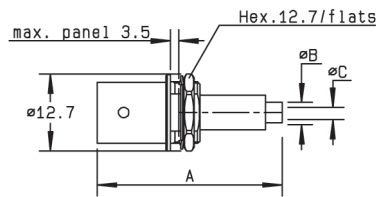

Fig. 1

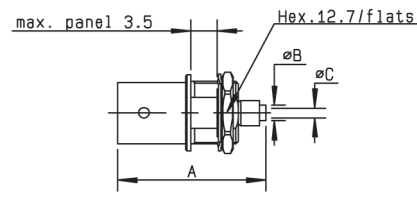

Fig. 2

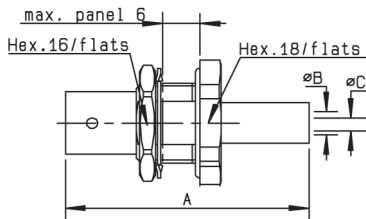

Fig. 3

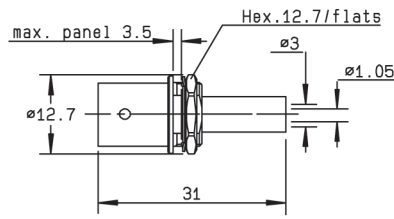

Fig. 4

| Cable group | Cable group dia. | Part number | Fig. | Dimensions (mm) | | | Captive center contact | Panel drilling | Note |
|-------------|------------------|---------------------|------|-----------------|------|------|------------------------|----------------|---|
| | | | | A | B | C | | | |
| RG174/RG316 | 2.6/50/S | R141 306 000 | 1 | 34 | 1.7 | | yes | P18 | |
| | | R141 306 503 | 2 | 26 | 2.95 | 0.6 | | | Reverse crimping/commercial version |
| | | R141 331 500 | 3 | 38.5 | 1.7 | | P14 or P20 | Panel sealed | |
| | | R141A 306 000 | 1 | 31 | 1.7 | 0.6 | no | P18 | ECO version |
| | | R141A 331 500 | 3 | 34 | 1.6 | 0.7 | no | P14 | Panel sealed ECO version |
| RG58/RG141 | 5/50/S | R141A 332 161 | 3 | 34 | 3.1 | 1.2 | no | | Panel sealed ECO version |
| | | R141 308 000 | 4 | | | | | P18 | Single piece body |
| | | R141 332 161 | | | | | yes | P14 or P20 | Panel sealed/commercial version |
| | | R141 332 500 | 3 | 35.5 | 3.1 | 1.05 | | | Panel sealed Reverse crimping/single piece body |

For other types of cables (75Ω, 93Ω or BT cables), please see "additional connectors" on page 10-32.

To download data sheets and assembly instructions, visit www.radiall.com & enter the part number in the Search box.

Bold part numbers represent products typically in stock & available for immediate shipment.

See page 8 and 9 for packaging information.

FLANGE RECEPTACLES

FLANGE RECEPTACLES

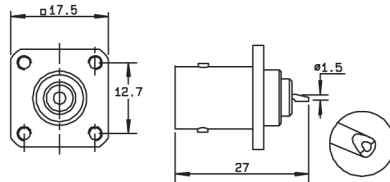

Fig. 1

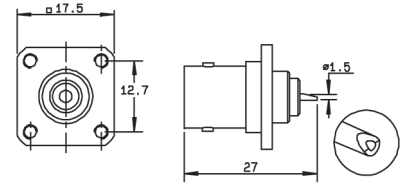

Fig. 2

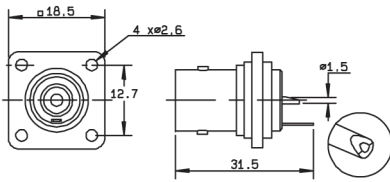

Fig. 3

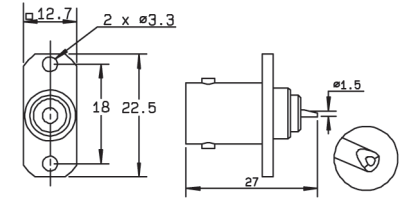

Fig. 4

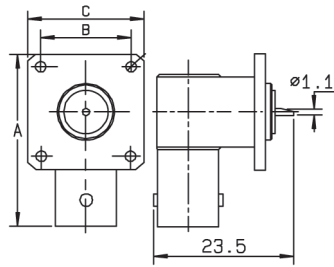

Fig. 5

| Part number | Fig. | Dimensions (mm) | | | Captive center contact | Panel drilling | Flange holes | Note |
|---------------------|------|-----------------|------|------|------------------------|----------------|--------------|-----------------------------|
| | | A | B | C | | | | |
| R141 403 000 | 1 | | | | yes | P08 | 4 x M2.5 | |
| R141 404 000 | 2 | | | | | P07 | 4 x M2.5 | |
| R141 406 000 | 1 | | | | | P08 | 4 x M2.6 | |
| R141 407 000 | 2 | | | | | P07 | | |
| R141 410 000 | 3 | | | | | P02 | | Insulated flange/solder tag |
| R141 453 000 | 4 | | | | | P24 | | 2 hole flange |
| R141 653 000 | 5 | 27.6 | 13.5 | 19 | | P05 | 4 x M3.3 | Right angle receptacle |
| R141 654 000 | | 26.9 | 12.7 | 17.5 | | P06 | 4 x M2.6 | Right angle receptacle |

STRAIGHT BULKHEAD RECEPTACLES WITH SOLDER POT

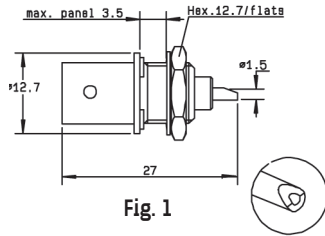

Fig. 1

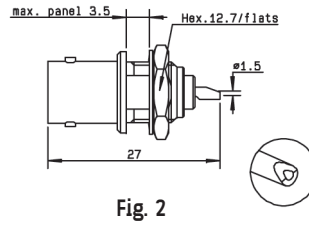

Fig. 2

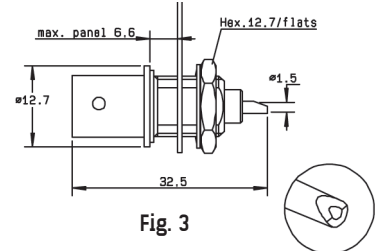

Fig. 3

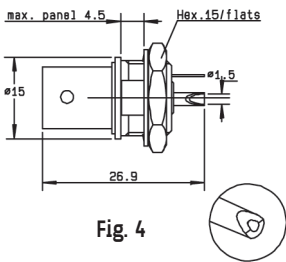

Fig. 4

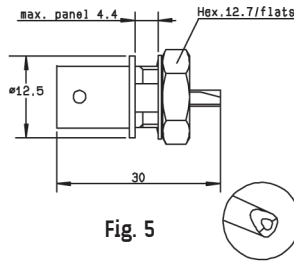

Fig. 5

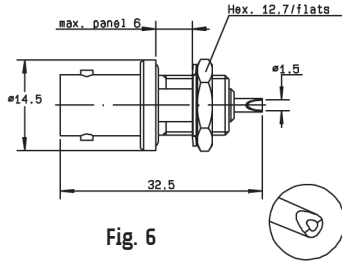

Fig. 6

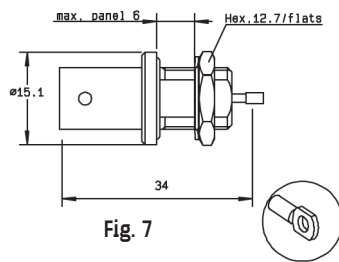
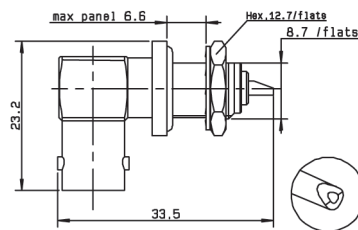

Fig. 7

| Part number | Fig. | A (Length) | Captive center contact | Panel drilling | Note | |
|---------------|------|------------|------------------------|----------------|---|-----------------------------------|
| R141 554 000 | 1 | | yes | P16 | | |
| R141 557 000 | 2 | | | P18 | Solder tag | |
| R141 559 000 | 3 | | | | Silver plated center contact/ commercial version | |
| R141 563 161 | 2 | | | | P14 | Insulated receptacle + solder tag |
| R141 572 000 | 4 | | | P18 | | Commercial version/insulated |
| R141 574 000 | 5 | | | | P19 | Fully sealed/Q200-5 insulator |
| R141 574 161 | | | | Fully sealed | | |
| R141 603 000 | 6 | | | P29 | Not sealed/ECO version | |
| R141 605 000 | | | | | | |
| R141A 605 000 | 3 | 28 | | | | |
| R141 625 000 | 7 | | | | P18 | Hermetically sealed |

RIGHT ANGLE BULKHEAD RECEPTACLE WITH SOLDER POT



| Part number | Captive center contact | Panel drilling |
|--------------|------------------------|----------------|
| R141 680 000 | yes | P18 |

To download data sheets and assembly instructions, visit www.radiall.com & enter the part number in the Search box. **Bold** part numbers represent products typically in stock & available for immediate shipment. See page 8 and 9 for packaging information.

RECEPTACLES

RECEPTACLES

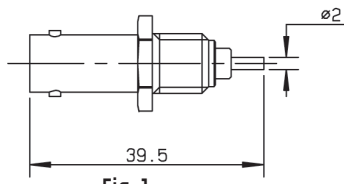
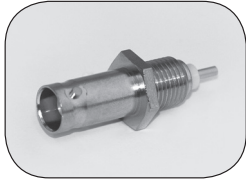

Fig. 1

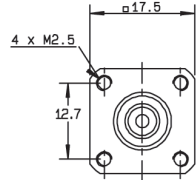

Fig. 2

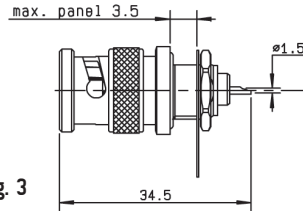
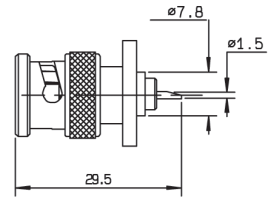

Fig. 3

| Part number | Fig. | Captive center contact | Panel drilling | Note |
|--------------|------|------------------------|----------------|---|
| R141 561 161 | 1 | yes | P22 | Screw on receptacle |
| R141 440 000 | 2 | | P03 | Male square flange |
| R141 580 000 | 3 | | P18 | Male bulkhead / Panel sealed / Solder tag |

STRAIGHT PCB FEMALE RECEPTACLES

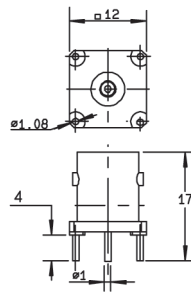
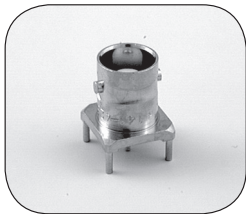

Fig. 1

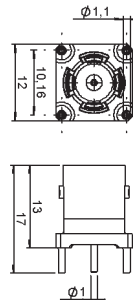

Fig. 2

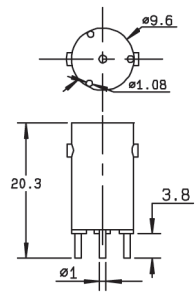

Fig. 3

| Part number | Fig. | Captive center contact | Panel drilling | Note |
|--------------|------|------------------------|----------------|------------------------------------|
| R141 426 000 | 1 | yes | P09 | Die cast body / commercial version |
| R141 426 161 | 2 | | | |
| R141 508 200 | 3 | | P21 | |

RIGHT ANGLE PCB FEMALE RECEPTACLES

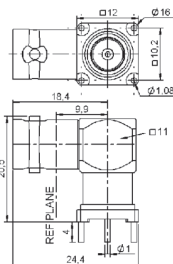

Fig. 1

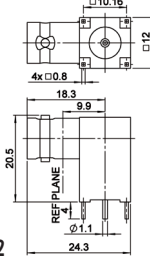

Fig. 2

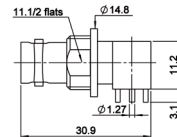

Fig. 3

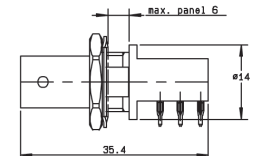

Fig. 4

| Part number | Fig. | Captive center contact | Panel drilling | Finish | Note |
|---------------|------|------------------------|----------------|--------|---|
| R141 665 000 | 1 | yes | P25 | Nickel | Rear mount / ECO version Packaging 10 / press-fit pins |
| R141 665 200 | 2 | | P09 | | |
| R141A 676 121 | 3 | | P26 and P30 | | |
| R141 684 130 | 4 | | P11 and P20 | | |

IN SERIES ADAPTERS

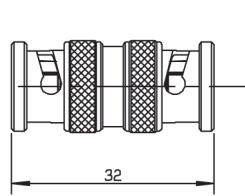

Fig. 1

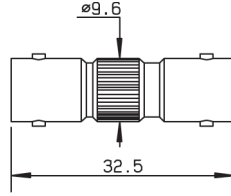

Fig. 2

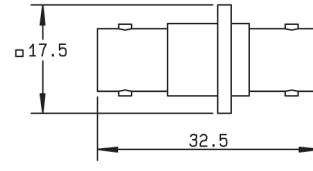

Fig. 3

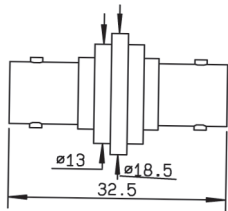

Fig. 4

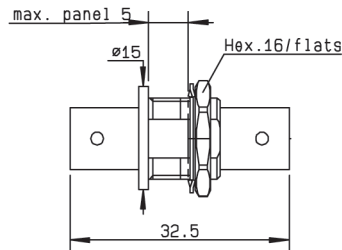

Fig. 5

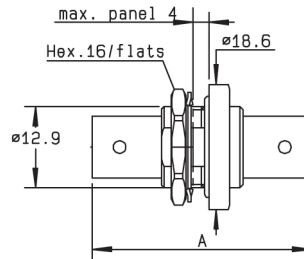

Fig. 6

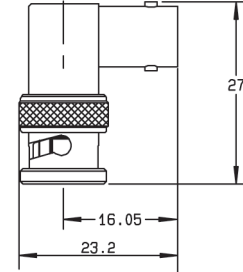

Fig. 7

| Part number | Fig. | Captive center contact | Dimension A (mm) | Flange holes | Panel drilling | Note | | |
|---------------|------|------------------------|------------------|--------------|----------------|-----------------|--|---|
| R141 703 000 | 1 | yes | | | | Male - male | | |
| R141 704 000 | 2 | | | | | Female - female | | |
| R141 710 000 | 3 | | | | 4 x M2.5 | P13 | Female - female square flange | |
| R141 717 000 | 4 | | | | 4 x 2.6 | P02 | Female - female square insulated flange | |
| R141 720 000 | 5 | | | | | P17 | Female - female bulkhead | |
| R141A 720 000 | | | | | | | Female - female bulkhead/ECO version | |
| R141 723 000 | | | | | | | P17 or P20 | Female - female insulated bulkhead |
| R141 723 161 | | | | | | | | Female - female insulated bulkhead/commercial version |
| R141 730 000 | 6 | | | 35.7 | | | Female - female panel sealed bulkhead | |
| R141 753 000 | | | | 35.3 | | P17 | Female - female hermetically sealed bulkhead | |
| R141 770 000 | 7 | | | | | | Male - female right angle | |

To download data sheets and assembly instructions, visit www.radiall.com & enter the part number in the Search box. **Bold** part numbers represent products typically in stock & available for immediate shipment. See page 8 and 9 for packaging information.

ADAPTERS AND CAPS

CROSS AND TEE IN SERIES ADAPTERS

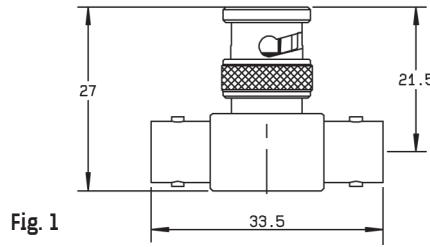

Fig. 1

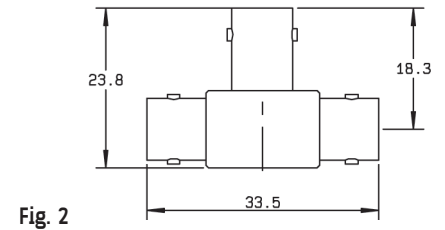

Fig. 2

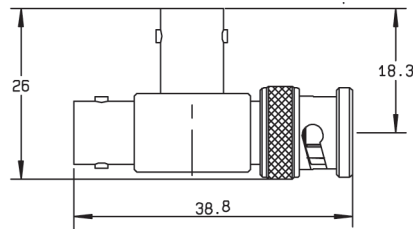

Fig. 3

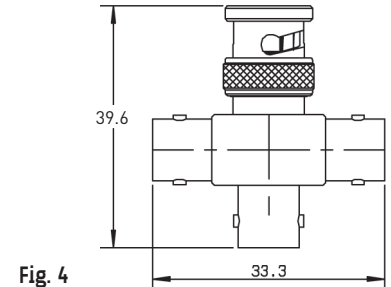

Fig. 4

| Part number | Fig. | Captive center contact | Note |
|--------------|------|------------------------|--|
| R141 780 000 | 1 | yes | Male/female-female tee |
| R141 782 000 | 2 | | Female/female-female tee |
| R141 789 000 | 3 | | Female/female-male tee |
| R141 799 000 | 4 | | Male/female-female-female cross/unit packaging |

MALE AND FEMALE CAPS

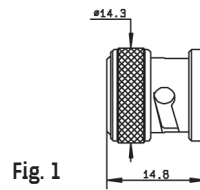

Fig. 1

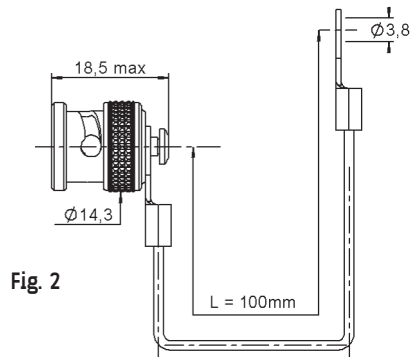

Fig. 2

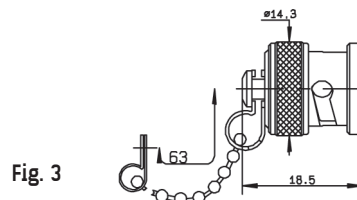

Fig. 3

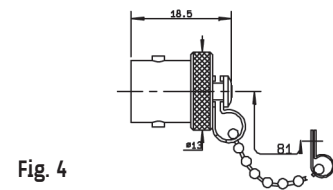

Fig. 4

| Part number | Fig. | Note |
|--------------|------|-------------------------------|
| R141 802 000 | 1 | Male |
| R141 805 000 | 2 | Male with cord |
| R141 812 000 | 3 | Male with chain |
| R141 842 000 | 4 | Female with chain |
| R141 862 000 | 3 | Male short circuit/with chain |

STRAIGHT PLUGS CLAMP TYPE FOR FLEXIBLE CABLES

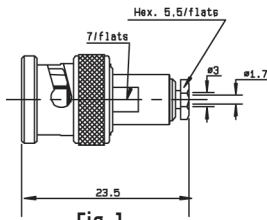
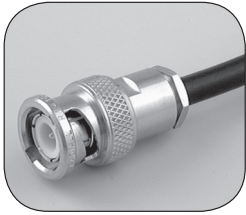

Fig. 1

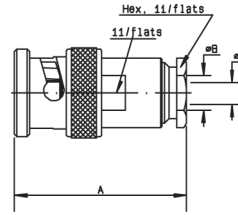

Fig. 2

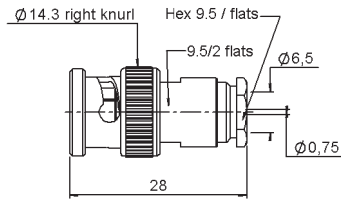

Fig. 3

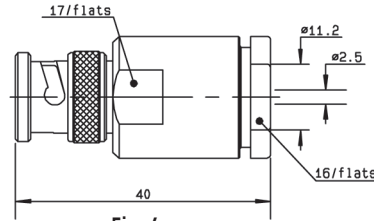

Fig. 4

| Cable group | Cable group dia. | Part number | Fig. | Dimensions (mm) | | | Captive center contact | Note |
|-----------------------|------------------|---------------------|------|-----------------|-----|------|------------------------|--------------------|
| | | | | A | B | C | | |
| RG179 | 2.6/75/S | R142 004 000 | 1 | | | | | |
| RG59/RG62 | 6/75/S | R142 016 000 | 2 | 28 | 6.6 | 0.75 | yes | Unit packaging |
| | | R142 016 161 | 3 | | | | | Commercial version |
| RG6A/U | 8/75/S + D | R142 017 000 | 2 | 45.5 | 9.1 | 1.5 | yes | Unit packaging |
| RG216/RG11/RG12/RG144 | 10 + 11/75/S + D | R142 018 000 | 4 | | | | | |

STRAIGHT PLUGS FULL CRIMP TYPE FOR FLEXIBLE CABLES

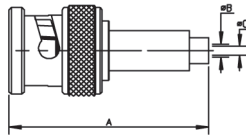

Fig. 1

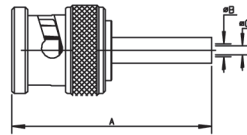

Fig. 2

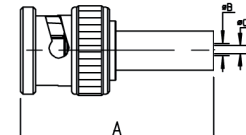

Fig. 3

| Cable group | Cable group dia. | Part number | Fig. | Dimensions (mm) | | | Captive center contact | Note |
|-----------------|------------------|---------------------|------|-----------------|-------|------|--------------------------------------|--------------------------------------|
| | | | | A | B | C | | |
| RG179 | 2.6/75/S | R142 076 000 | 1 | | | | yes | |
| | | R142 076 161 | 3 | 31 | 1.8 | 0.4 | | Commercial version |
| | | R142A 076 161 | 3 | 25.3 | 1.65 | 0.4 | no | Single piece body/ECO version |
| BT3002 | 3.6/75/D | R142 081 120 | 2 | 29 | 2.1 | 0.34 | | Single piece body |
| | | R142A 081 130 | 2 | 29 | 2.1 | 0.34 | | Single piece body/ECO version |
| BT2002 | 3.8/93/S | R142 078 161 | 3 | 30 | 3.85 | 0.6 | yes | Commercial version |
| RG59/RG62 | 5/75/D | R142 083 000 | 2 | 27.3 | 5.5 | 0.75 | | Single piece body |
| | | R142 085 000 | | 28 | 6.6 | | | Single piece body |
| | 7/75/S | R142 085 161 | 3 | 28 | 3.9 | | no | Single piece body/Commercial version |
| | | R142A 085 161 | 3 | 29 | 4 | 0.8 | | Single piece body/ECO version |
| 7.5/75/D | R142 086 161 | 3 | 30.8 | 5.15 | 1.35 | yes | Single piece body/Commercial version | |
| RG11/RG12/RG144 | 10/75/S | R142 090 000 | 2 | 28 | 5.25 | 0.85 | | Single piece body |
| | | R142 095 000 | 2 | 28 | 11.05 | 1.35 | yes | Single piece body |

For others types of cables (75Ω, 93Ω or BT cables), please see "additional connectors" on page 10-32.

To download data sheets and assembly instructions, visit www.radiall.com & enter the part number in the Search box.

Bold part numbers represent products typically in stock & available for immediate shipment.

See page 8 and 9 for packaging information.

RIGHT ANGLE PLUGS AND JACKS

RIGHT ANGLE PLUGS CLAMP TYPE FOR FLEXIBLE CABLES

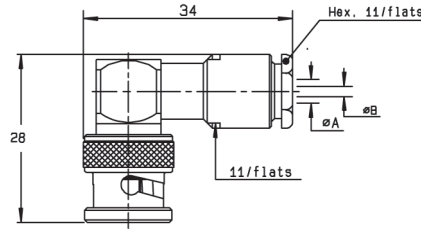

Fig. 1

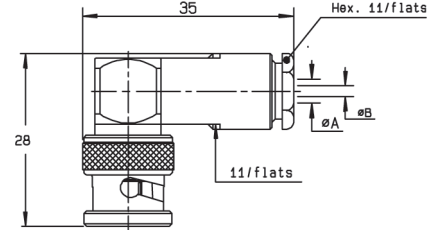

Fig. 2

| Cable group | Cable group dia. | Part number | Fig. | Dimensions (mm) | | Captive center contact |
|-------------|------------------|--------------|------|-----------------|------|------------------------|
| | | | | A | B | |
| RG179 | 2.6/75/S | R142 154 000 | 1 | 3.1 | 0.6 | yes |
| RG59/RG62 | 6/75/S | R142 157 000 | 2 | 6.6 | 0.75 | |

RIGHT ANGLE PLUGS FULL CRIMP TYPE FOR FLEXIBLE CABLES

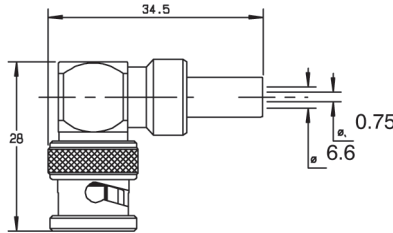

Fig. 1

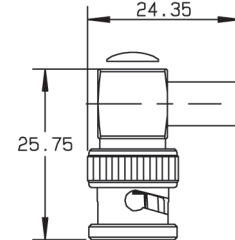
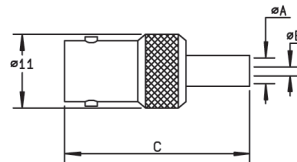

Fig. 2

| Cable group | Cable group dia. | Part number | Fig. | Captive center contact | Note |
|-------------|------------------|--------------|------|------------------------|--------------------|
| RG59/RG62 | 6/75/S | R142 184 000 | 1 | yes | |
| | | R142 184 161 | 2 | | Commercial version |

STRAIGHT JACKS FULL CRIMP TYPE FOR FLEXIBLE CABLES



| Cable group | Cable group dia. | Part number | Dimensions (mm) | | | Captive center contact | Note |
|-------------|------------------|--------------|-----------------|------|------|------------------------|--------------------------------------|
| | | | A | B | C | | |
| RG179 | 2.6/75/S | R142 217 000 | 1.75 | 0.4 | 32.5 | yes | |
| RG59/RG62 | 6/75/S | R142 242 000 | 6.6 | 0.75 | 29.5 | | Single piece body |
| | | R142 242 161 | | | 29 | | Single piece body/commercial version |

For others types of cables (75Ω, 93Ω or BT cables), please see "additional connectors" on page 10-32.
 To download data sheets and assembly instructions, visit www.radiall.com & enter the part number in the Search box.
Bold part numbers represent products typically in stock & available for immediate shipment.
 See page 8 and 9 for packaging information.

STRAIGHT SQUARE FLANGE JACKS CLAMP TYPE FOR FLEXIBLE CABLES

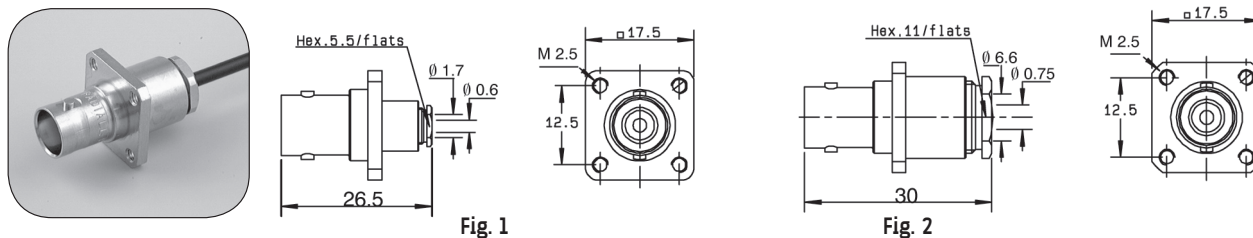

| Cable group | Cable group dia. | Part number | Fig. | Captive center contact | Panel drilling | Note |
|-------------|------------------|--------------|------|------------------------|----------------|----------------|
| RG179 | 2.6/75/S | R142 202 000 | 1 | yes | P01 | Unit packaging |
| RG59/RG62 | 6/75/S | R142 268 000 | 2 | | | |

STRAIGHT SQUARE FLANGE JACK FULL CRIMP TYPE FOR FLEXIBLE CABLES

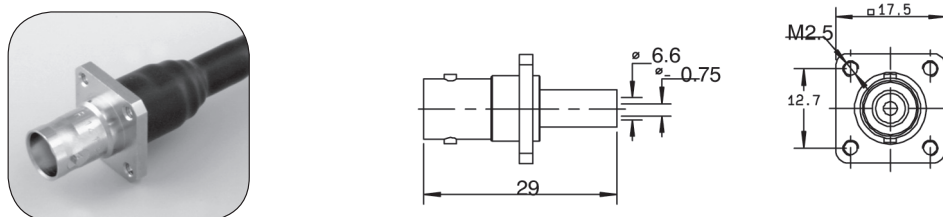

| Cable group | Cable group dia. | Part number | Captive center contact | Panel drilling | Note |
|-------------|------------------|--------------|------------------------|----------------|----------------------------------|
| RG59/RG62 | 6/75/S | R142 295 000 | yes | P01 | Single piece body/unit packaging |

STRAIGHT BULKHEAD JACK CLAMP TYPE FOR FLEXIBLE CABLES

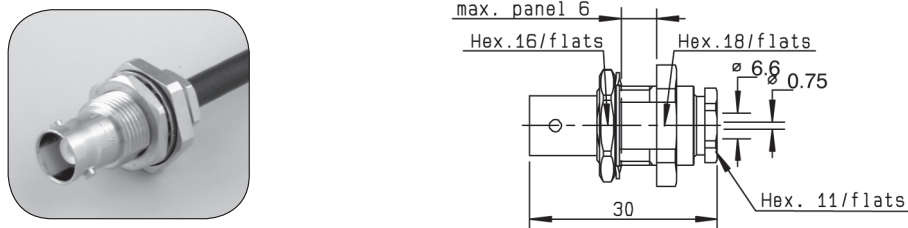

| Cable group | Cable group dia. | Part number | Captive center contact | Panel drilling | Note |
|-------------|------------------|--------------|------------------------|----------------|--------------|
| RG59/RG62 | 6/75/S | R142 329 000 | yes | P14 | Panel sealed |

For others types of cables (75Ω, 93Ω or BT cables), please see "additional connectors" on page 10-32.

To download data sheets and assembly instructions, visit www.radiall.com & enter the part number in the Search box.

Bold part numbers represent products typically in stock & available for immediate shipment.

See page 8 and 9 for packaging information.

BULKHEAD JACKS AND RECEPTACLES

STRAIGHT BULKHEAD JACKS CRIMP TYPE FOR FLEXIBLE CABLES

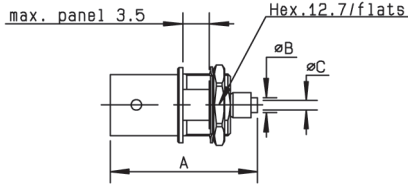

Fig. 1

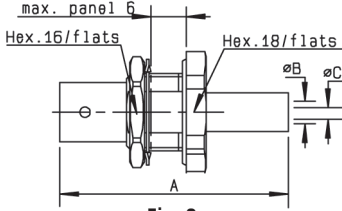

Fig. 2

| Cable group | Cable group dia. | Part number | Fig. | Dimensions (mm) | | | Captive center contact | Panel drilling | Note |
|-------------|------------------|---------------------|------|-----------------|------|------|------------------------|----------------|-------------------------------------|
| | | | | A | B | C | | | |
| RG179 | 2.6/75/S | R142 306 500 | 1 | 26 | 2.95 | 0.4 | yes | P18 | Reverse crimping/Commercial version |
| | | R142A 306 500 | | | | | no | | Reverse crimping/ECO version |
| | | R142 306 503 | | | | | yes | | Reverse crimping |
| | | R142 331 011 | 2 | 38 | 1.75 | 0.4 | | P14 or P20 | Panel sealed/Silver plated |
| BT3002 | 3.6/75/D | R142A 325 106 | 2 | 36 | 2.1 | 0.5 | no | P14 or P20 | Panel sealed/ECO version |
| RG59/RG62 | 6/75/S | R142 334 161 | 2 | 35 | 6.6 | 0.75 | yes | P14 or P20 | Panel sealed/Commercial version |
| RG59/RG62 | 6/75/S | R142A 334 161 | 2 | 35 | 3.8 | 0.7 | | P14 or P20 | Panel sealed/ECO version |

RECEPTACLES WITH SOLDER POT

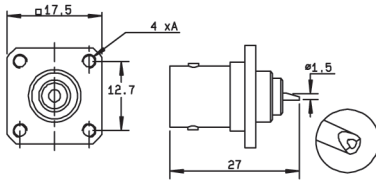
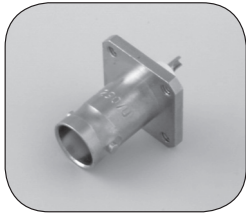

Fig. 1

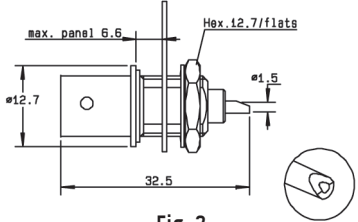

Fig. 2

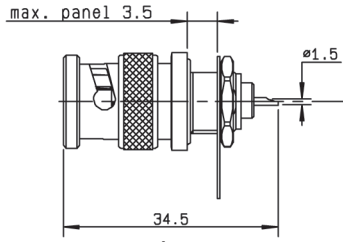

Fig. 3

| Part number | Fig. | Captive center contact | Panel drilling | Flange holes A | Note |
|--------------|------|------------------------|----------------|----------------|--|
| R142 412 000 | 1 | yes | P07 | 4 x M2.5 | Square flange + unit packaging |
| R142 562 000 | 2 | | P18 | | Bulkhead female receptacle unit packaging |
| R142 580 000 | 3 | | P18 | | Bulkhead male receptacle panel sealed + unit packaging |

For others types of cables (75Ω, 93Ω or BT cables), please see "additional connectors" on page 10-32.
 To download data sheets and assembly instructions, visit www.radiall.com & enter the part number in the Search box.
Bold part numbers represent products typically in stock & available for immediate shipment.
 See page 8 and 9 for packaging information.

STRAIGHT PCB FEMALE RECEPTACLES

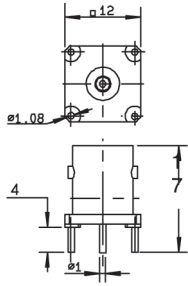
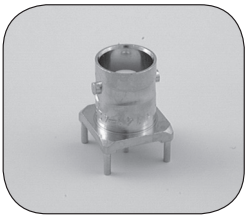

Fig. 1

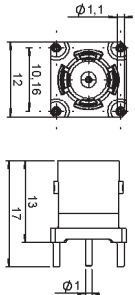
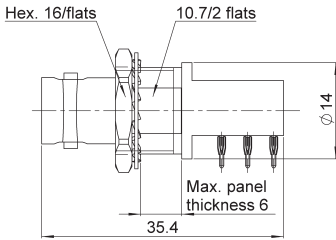

Fig. 2

| Part number | Fig. | Captive center contact | Panel drilling | Note |
|--------------|------|------------------------|----------------|--------------------|
| R142 426 020 | 1 | yes | P09 | |
| R142 426 261 | 2 | | | Commercial version |

RIGHT ANGLE PCB FEMALE RECEPTACLE



| Part number | Captive center contact | Panel drilling | Note |
|--------------|------------------------|----------------|----------------|
| R142 684 130 | yes | P11 and P20 | Press-fit pins |

To download data sheets and assembly instructions, visit www.radiall.com & enter the part number in the Search box. **Bold** part numbers represent products typically in stock & available for immediate shipment. See page 8 and 9 for packaging information.

ADAPTERS

IN SERIES ADAPTERS

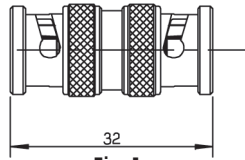

Fig. 1

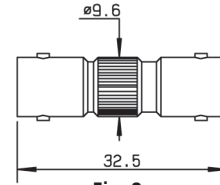

Fig. 2

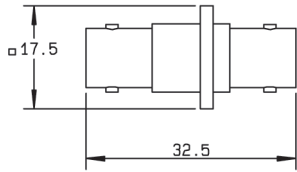

Fig. 3

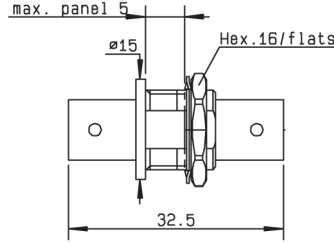

Fig. 4

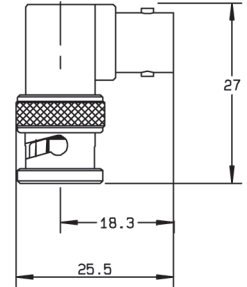

Fig. 5

| Part number | Fig. | Captive center contact | Panel drilling | Note |
|---------------------|------|------------------------|----------------|--|
| R142 703 000 | 1 | yes | | Male - male |
| R142 704 000 | 2 | | | Female - female |
| R142 710 000 | 3 | | P01 | Female - female square flange |
| R142 720 000 | 4 | | P14 | Female - female bulkhead |
| R142A 720 000 | 4 | | P14 | Female - female bulkhead - Eco version |
| R142 723 000 | 4 | | P14 or P20 | Female - female insulated bulkhead |
| R142 770 000 | 5 | | | Male - female right angle |

TEE IN SERIES ADAPTERS

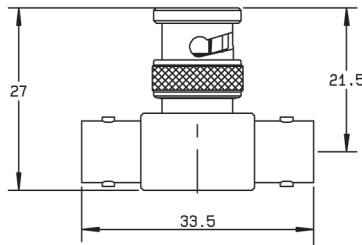

Fig. 1

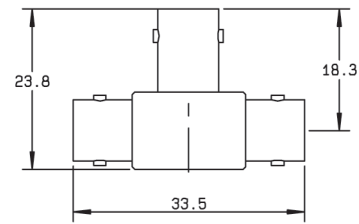

Fig. 2

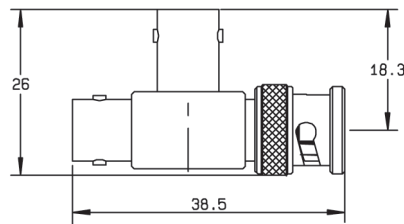

Fig. 3

| Part number | Fig. | Captive center contact | Note |
|---------------------|------|------------------------|--------------------------|
| R142 780 000 | 1 | yes | Male/female-female tee |
| R142 782 000 | 2 | | Female/female-female tee |
| R142 789 000 | 3 | | Female/female-male tee |

To download data sheets and assembly instructions, visit www.radiall.com & enter the part number in the Search box. **Bold** part numbers represent products typically in stock & available for immediate shipment. See page 8 and 9 for packaging information.

For more information regarding these connectors, please consult us.

CONNECTORS WITH FLAT GASKET

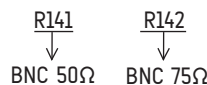

| P/N | Description | Captive center contact |
|--------------|--|------------------------|
| R141 007 000 | Straight plug clamp type for 5/50/S+D cable | no |
| R141 011 000 | Straight plug clamp type for 6/75/S cable | |
| R141 015 000 | Straight plug clamp type for 6/75/S cable | |
| R141 154 000 | Right angle plug clamp type for 2.6/50/S+D cable | yes |
| R141 256 000 | Straight square flange jack clamp type for 5/50/S+D cable | no |
| R141 257 000 | Straight square flange jack clamp type for 5/50/S cable | |
| R141 261 000 | Straight square flange jack clamp type for 6/75/S cable | |
| R142 017 000 | Straight plug clamp type for 8/75/S+D cable (unit packaging) | yes |

50Ω CONNECTORS FOR 75Ω or 93Ω CABLE

75Ω Cable

| P/N | Description | Captive center contact |
|--------------|---|------------------------|
| R141 004 000 | Straight plug clamp type for 2.6/75/S cable | yes |
| R141 011 000 | Straight plug clamp type for 6/75/S cable | no |
| R141 012 000 | Straight plug clamp type for 6/75/S cable | |
| R141 013 000 | Straight plug clamp type for 6/75/S cable | no |
| R141 015 000 | Straight plug clamp type for 6/75/S cable | no |
| R141 154 000 | Right angle plug clamp type for 2.6/75/D cable | yes |
| R141 261 000 | Straight square flange jack clamp type for 6/75/S cable | no |
| R141 277 000 | Straight insulated square flange jack clamp type for 2.6/75/S cable | yes |
| R141 278 000 | Straight square flange jack clamp type for 2.6/75/S cable | |
| R141 329 000 | Straight bulkhead jack clamp type for 6/75/S cable | |

93Ω Cable

| P/N | Description | Captive center contact |
|--------------|---|------------------------|
| R141 013 000 | Straight plug clamp type for 6/93/S cable | no |
| R141 077 000 | Straight plug crimp type for 3.8/93/S cable | yes |

75Ω CONNECTORS FOR 93Ω CABLE

| P/N | Description | Packaging |
|--------------|---|------------|
| R142 016 000 | Straight plug clamp type for 6/93/S cable | unit |
| R142 078 161 | Straight plug crimp type for 3.8/93 cable | 100 pieces |

CONNECTORS FOR BT OR SPECIAL CABLES

| P/N | Description | Packaging |
|--------------|--|------------|
| R141 003 420 | Straight plug clamp type for 2.2/50D cable | unit |
| R141 005 000 | Straight plug clamp type dia 3.5/50, PPD cable | 100 pieces |
| R141 015 000 | Straight plug clamp type dia 6/75/S, 75PD cable | |
| R142 081 100 | Straight plug crimp type for 3.6/75/D, P46431 cable | |
| R142 081 120 | Straight plug crimp type for BT3002, TZ0 75024 cable | unit |
| R142 081 320 | Straight plug crimp type for BT2001 cable | 100 pieces |
| R142 091 161 | Straight plug crimp type for ST212 cable | |

CHARACTERISTICS

| Test/characteristics | Values/remarks | |
|---|---|---|
| Frequency range | DC - 10 GHz | |
| Impedance | 50Ω | |
| Working voltage | 500 Vrms | |
| Dielectric withstanding voltage Between center conductor and inner screen Between inner screen and outer screen | Unmated connector 1500 Vrms 1000 Vrms | Mated connector 3000 Vrms 1000 Vrms |
| Temperature range | -55°C / +125°C | |

PLUG, JACK AND RECEPTACLE

STRAIGHT PLUG CLAMP TYPE

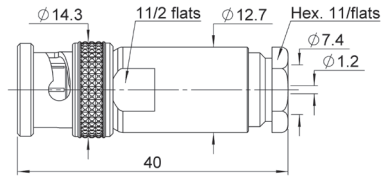

| Cable group dia. | Part number |
|------------------|--------------|
| 7.3/50/D | R266 010 000 |

STRAIGHT JACK CLAMP TYPE

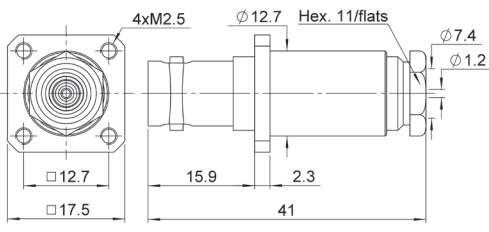

| Cable group dia. | Part number | Panel Drilling |
|------------------|--------------|----------------|
| 7.3/50/D | R266 260 000 | P13 |

RECEPTACLE

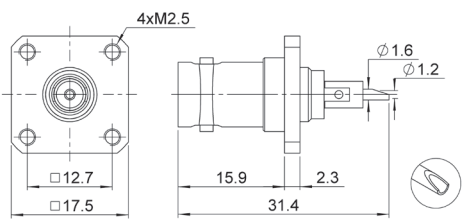

| Part number | Panel Drilling |
|--------------|----------------|
| R266 403 000 | P13 |

To download data sheets and assembly instructions, visit www.radiall.com & enter the part number in the Search box. **Bold** part numbers represent products typically in stock & available for immediate shipment. See page 8 and 9 for packaging information.

P01

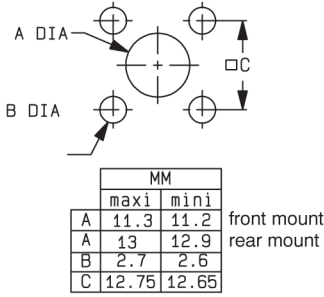

P02

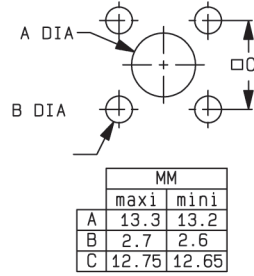

P03

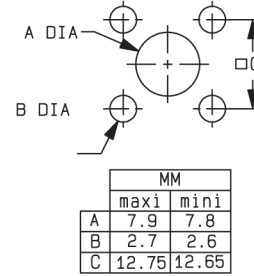

P04

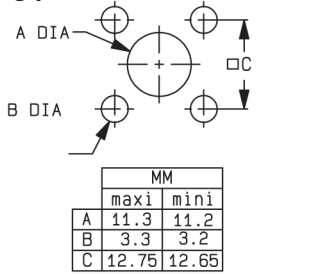

P05

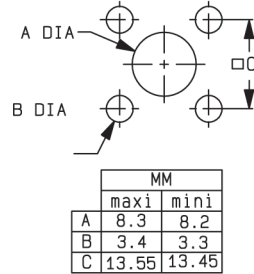

P06

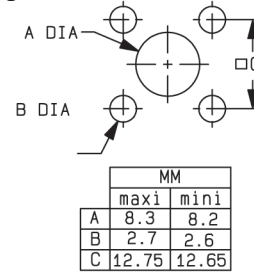

P07

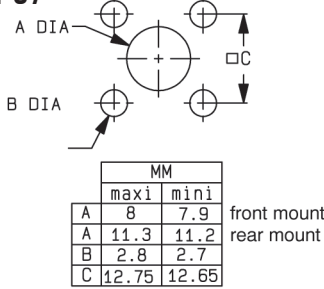

P08

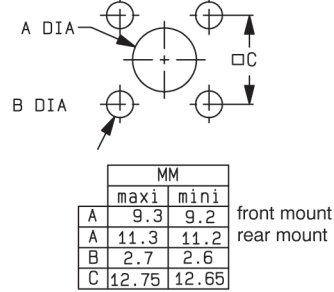

P09

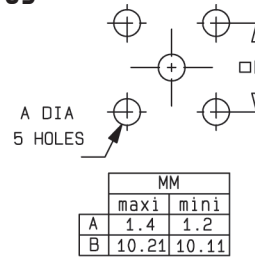

P10

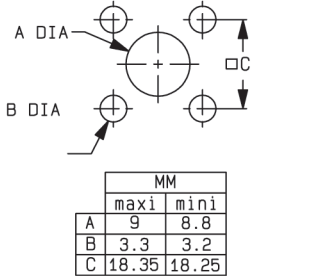

P11

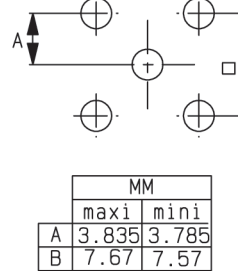

P12

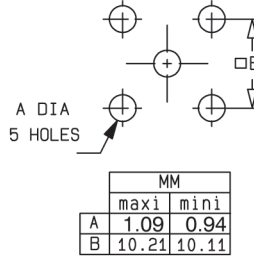

P13

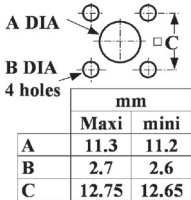

P14

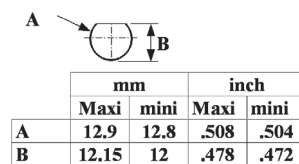

P15

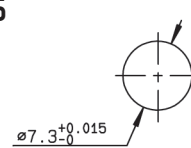

PANEL DRILLING

P16

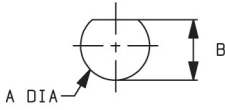

| MM | | |
|----|-------|-------|
| | maxi | mini |
| A | 11.25 | 11.15 |
| B | 10.43 | 10.35 |

P17

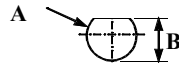

| mm | | |
|----|-------|-------|
| | Maxi | mini |
| A | 12.9 | 12.8 |
| B | 12.04 | 11.94 |

P18

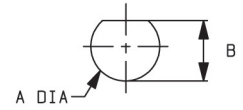

| MM | | |
|----|------|------|
| | maxi | mini |
| A | 9.7 | 9.6 |
| B | 8.9 | 8.8 |

P19

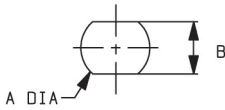

| MM | | |
|----|------|------|
| | maxi | mini |
| A | 9.75 | 9.65 |
| B | 8.65 | 8.55 |

P20

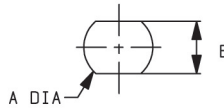

| MM | | |
|----|------|------|
| | maxi | mini |
| A | 12.8 | 12.7 |
| B | 10.9 | 10.8 |

P21

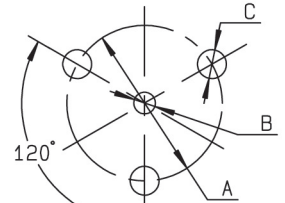

| MM | | |
|----|------|------|
| | maxi | mini |
| A | 8.65 | 8.55 |
| B | 1.3 | 1.1 |
| C | 1.7 | 1.5 |

P22

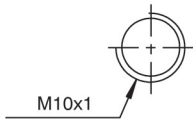

P23

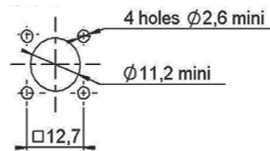

P24



| mm | | |
|--------------|------|------|
| | Maxi | mini |
| A (F. Mount) | 9 | 8.9 |
| A (R. Mount) | 11.3 | 11.2 |
| B | 3.4 | 3.3 |
| C | 18.1 | 18 |

P25

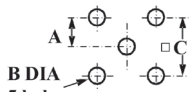

| mm | | |
|----|-------|-------|
| | Maxi | mini |
| A | 5.105 | 5.055 |
| B | 1.4 | 1.2 |
| C | 10.21 | 10.11 |

P26



| mm | | |
|----|------|------|
| | Maxi | mini |
| A | 1.4 | 1.3 |
| B | 2.1 | 2 |
| C | 6.6 | 6.5 |

P27



| mm | | |
|----|------|------|
| | Maxi | mini |
| A | 1.15 | 1.05 |
| B | 2.26 | 2.16 |
| C | 6.96 | 6.76 |

P28



| mm | | |
|----|------|------|
| | Maxi | mini |
| A | 0.65 | 0.55 |
| B | 1.3 | 1.2 |
| C | 6.3 | 6.2 |

P29

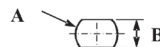

| mm | | |
|----|------|------|
| | Maxi | mini |
| A | 10.2 | 10.0 |
| B | 9.3 | 9.2 |

P30



| mm | | |
|----|------|------|
| | Maxi | mini |
| A | 11.3 | 11.2 |
| B | 12.9 | 12.8 |

P31

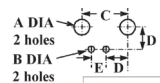

| mm | | |
|----|-------|-------|
| | Maxi | mini |
| A | 2.05 | 1.95 |
| B | 1.0 | 0.8 |
| C | 10.21 | 10.11 |
| D | 5.13 | 5.03 |
| E | 2.59 | 2.49 |



AEROSPACE



AUTOMOTIVE



DEFENSE



INDUSTRIAL



INSTRUMENTATION



MEDICAL



SPACE



TELECOM

EUROPE

France - RADIALL S.A.

101, Rue Ph. Hoffmann
93116 ROSNY sous BOIS (Paris)
Tel.: +33 1 49 35 35 35 - Fax: +33 1 48 54 63 63
E-Mail: info@radiall.com

Finland - RADIALL SF

P.O. Box 202 - 90101 OULU
Tel.: +358 407 522 412
E-Mail: infofi@radiall.com

Germany - RADIALL GmbH

Carl-Zeiss Str. 10 Postfach 200143
D63307 - RÖDERMARK (Frankfurt)
Tel.: +49 60 74 91 07 0 - Fax: +49 60 74 91 07 70
E-Mail: infode@radiall.com

Italy - RADIALL Elettronica S.R.L.

Via Concordia, 5 - 20090 ASSAGO MILANO
Tel.: +39 02 48 85 121 - Fax: +39 02 48 84 30 18
E-Mail: infoit@radiall.com
Regional office: Roma

Netherlands - RADIALL B.V.

Hogebrinkerweg 15b - 3871 KM HOEVELAKEN
Tel.: +31 33 253 40 09 - Fax: +31 33 253 45 12
E-Mail: infofl@radiall.com

Sweden - RADIALL A.B.

Sjöängsvägen 2 - SE-192 72 SOLLENTUNA (Stockholm)
Tel.: +46 844 434 10 - Fax: +46 875 449 16
E-Mail: infose@radiall.com

U.K. - RADIALL Ltd.

Ground Floor, 6 The Grand Union Office Park,
Packet Boat Lane
UXBRIDGE Middlesex UB8 2GH (London)
Tel.: +44 1895 425 000 - Fax: +44 1895 425 010
E-Mail: infouk@radiall.com

NORTH AMERICA

USA - RADIALL USA, Inc.

6825 West Galveston Street
CHANDLER, Arizona 85226
Tel.: +1 480 682 9400 - Fax: +1 480 682 9403
E-Mail: infousa@radiall.com

ASIA

China - SHANGHAI RADIALL Electronic Co., Ltd.

N° 390 Yong He Road 200072 - SHANGHAI
Tel.: +86 21 66 52 37 88 - Fax: +86 21 66 52 11 77
E-Mail: infosh@radiall.com

Japan - NIHON RADIALL

Shibuya-ku Ebisu 1-5-2, Kougetsu Bldg 405
TOKYO 150-0013
Tel.: +81 3 3440 6241 - Fax: +81 3 3440 6242
E-Mail: infojp@radiall.com

Hong Kong - RADIALL Electronics Ltd.

Flat D, 6/F, Ford Glory Plaza,
37-39 Wing Hong Street
Cheung Sha Wan
KOWLOON HONG KONG
Tel: +852-2959-3833 - Fax: +852-2959-2636
E-Mail: infohk@radiall.com

India - RADIALL India Pvt. Ltd.

25 D, II Phase, Peenya Industrial Area
BANGALORE 560058
Tel.: +91 80 83 95 271 - Fax: +91 80 83 97 228
E-Mail: infoin@radiall.com

ALSO REPRESENTED IN

| | | |
|----------------|-------------|--------------|
| Australia | Hungary | Poland |
| Austria | Indonesia | Russia |
| Belgium | Israel | Singapore |
| Brazil | Korea | Spain |
| Czech Republic | Latvia | Switzerland |
| Denmark | Lithuania | Taiwan |
| Estonia | Malaysia | Thailand |
| Greece | Norway | Vietnam |
| | Philippines | South Africa |

For the above countries, please contact the local agent or RADIALL at info@radiall.com



Mouser Electronics

Authorized Distributor

Click to View Pricing, Inventory, Delivery & Lifecycle Information:

Radial:

[R141004000W](#) [R141306000W](#) [R141075000W](#) [R141572000W](#) [R141559000W](#) [R141426000W](#) [R142076000W](#)
[R141082000W](#) [R141703000W](#) [R141554000W](#) [R142016000W](#) [R141154000W](#) [R141182000W](#) [R141704000W](#)
[R141327000W](#) [R142704000W](#) [R141557000W](#) [R141207000W](#) [R141323000W](#) [R161332000W](#) [R141237000W](#)
[R142095000W](#) [R142018000W](#) [R141605000W](#) [R141083000W](#) [R141770000W](#) [R141237000](#) [R142704000](#)
[R141753000](#) [R141704000](#) [R141770000](#) [R141789000](#) [R141723000](#) [R141717000](#) [R141723000W](#) [R141789000W](#)
[R141717000W](#) [R141782000](#) [R141782000W](#) [R141003000](#) [R141723161](#) [R141003000W](#) [R141799000](#)
[R141730000W](#)