

FEATURES

- Heavy-duty die cast zinc handle
- Designed for repetitive fixing or clamping
- Ideal for use in small spaces
- Blackened steel inserts
- M5 to M12 thread sizes

RS PRO Steel Clamping Lever, M6 x 8mm

RS Stock No.: 478-529



RS Professionally Approved Products bring to you professional quality parts across all product categories. Our product range has been tested by engineers and provides a comparable quality to the leading brands without paying a premium price.

Product Description

These die cast zinc clamping leavers with a steel metric male thread from our own RS PRO brand are designed primarily to tighten or loosen screws eliminating the need for any special tools or wrenches. Clamp levers are ideal for use in hard to reach or confined spaces. Clamp levers are available in a range of thread sizes and stem lengths to suit a wide variety of applications.

General Specifications

Lever Type	Clamping Lever
Thread Gender	Female
Thread Size	M6
Handle Material	Die Cast Zinc
Insert Material	Steel
Colour	Black
Applications	Clamping levers are utilised in applications where screws are repeatedly tightened or loosened. They are useful when machinery must be swapped over, maintained or height adjustment is required regularly; Height Adjustment - Clamping levers can be used to adjust the height of tripods or metal framework and stands; Machinery Maintenance - Clamping levers are used to release fixings while performing critical machine maintenance. The time saving device allows for quick release and retightening of screws saving valuable machine down time

Mechanical Specifications

Thread/Insert Length	8mm
Length	42mm

Approvals

Compliance/Certifications	RoHS Certificate Of Compliance
---------------------------	--------------------------------

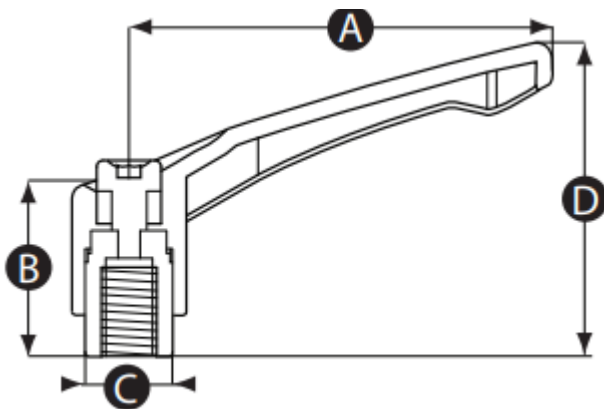

Part No.	A	B	C	D	Thread size	Insert material	Handle Colour
478191	42	25	10	37	M4	Steel	Black
478450	42	25	10	37	M5	Steel	Black
478529	42	25	10	37	M6	Steel	Black
478107	42	25	10	37	M6	Stainless Steel	Black
478539	65	31	14	49	M6	Steel	Black
478406	65	31	14	49	M6	Stainless Steel	Black
478494	65	31	14	49	M8	Steel	Black
478131	65	31	14	49	M8	Stainless Steel	Black
478456	78	36	16	57	M8	Steel	Black
478185	78	36	16	57	M8	Stainless Steel	Black
478535	78	36	16	57	M10	Steel	Black
478181	78	36	16	57	M10	Stainless Steel	Black
478602	92	43	19	65	M10	Steel	Black
478179	92	43	19	65	M10	Stainless Steel	Black
478579	92	43	19	65	M12	Steel	Black
478175	92	43	19	65	M12	Stainless Steel	Black