



Photocoupler

Product Data Sheet

MOC3063-A SERIES

Spec No.: DS70-2010-0011

Effective Date: 05/09/2014

Revision: A

LITE-ON DCC

RELEASE

BNS-OD-FC001/A4

Photocouplers MOC3063-A SERIES

1. DESCRIPTION

1.1 Features

- 5 Pin DIP zero-cross opto isolators triac driver output
- High input-output isolation voltage
Viso = 5,000Vrms
- High repetitive peak off-state voltage
V_{DRM}: Min. 600 V.
- High critical rate of rise of off-state voltage
dv/dt: Min.600V / μs
- Dual-in-line package :
MOC3063-A
- Wide lead spacing package :
MOC3063M-A
- Surface mounting package :
MOC3063S-A
- Tape and reel packaging :
MOC3063S-TA-A, MOC3063S-TA1-A
- Safety approval
 - * UL approved (No. E113898)
 - * TUV approved (No. R9653630)
 - * CSA approved (No. CA91533-1)
 - * FIMKO approved (No. 193422-01)
 - * VDE approved (No. 40015248)
 - * CQC approved (No.CQC11001061921-2)
- RoHS Compliance
All materials be used in device are followed EU RoHS directive (No.2002/95/EC).
- ESD pass HBM 8000V/MM2000V
- MSL class1

1.2 Applications

- Motor Controls.
- Solid state relays
- For triggering high power thyristor and triac
- Household use equipment

Photocouplers MOC3063-A SERIES

2. PACKAGE DIMENSIONS

2.1 MOC3063-A :

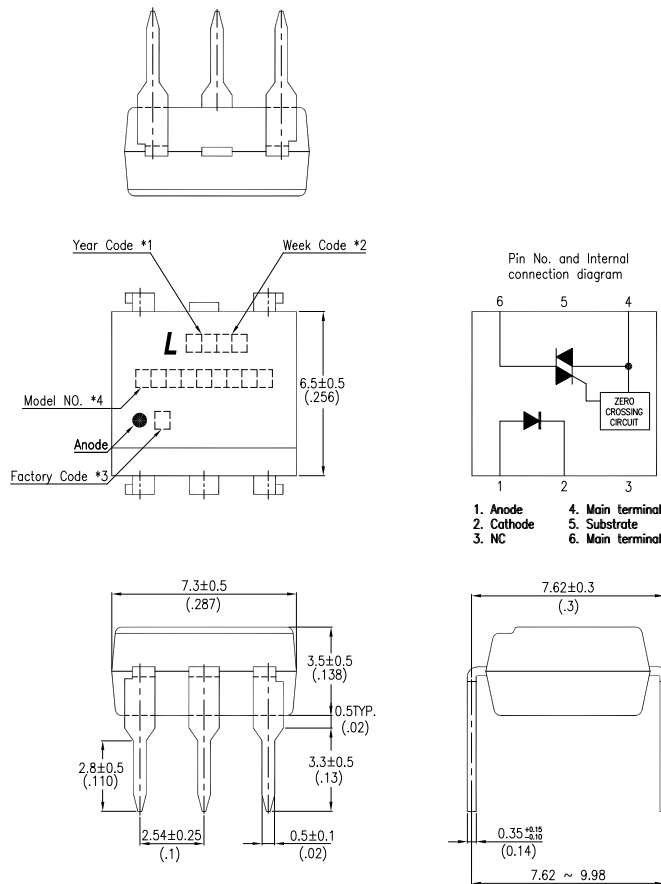

Notes :

1. Year date code.
2. 2-digit work week.
3. Factory identification mark shall be marked (Y: Thailand, W: China-CZ, X: China-TJ).
4. Model No.: MOC3063-A

Photocouplers MOC3063-A SERIES

2.2 MOC3063M-A :

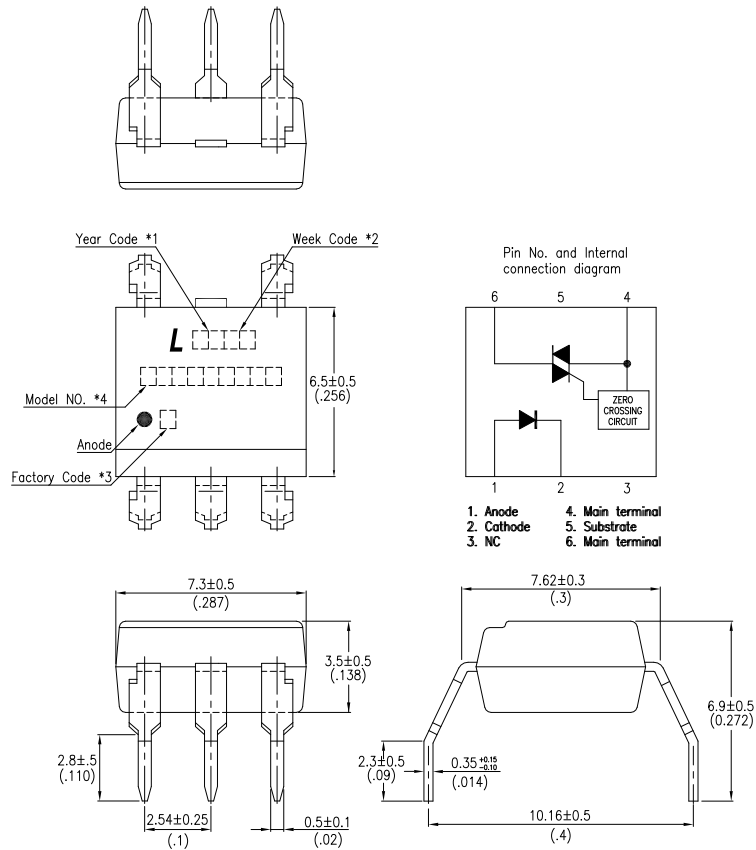

Notes :

1. Year date code.
2. 2-digit work week.
3. Factory identification mark shall be marked (Y: Thailand, W: China-CZ, X: China-TJ).
4. Model No.: MOC3063-A

Photocouplers MOC3063-A SERIES

2.3 MOC3063S-A :

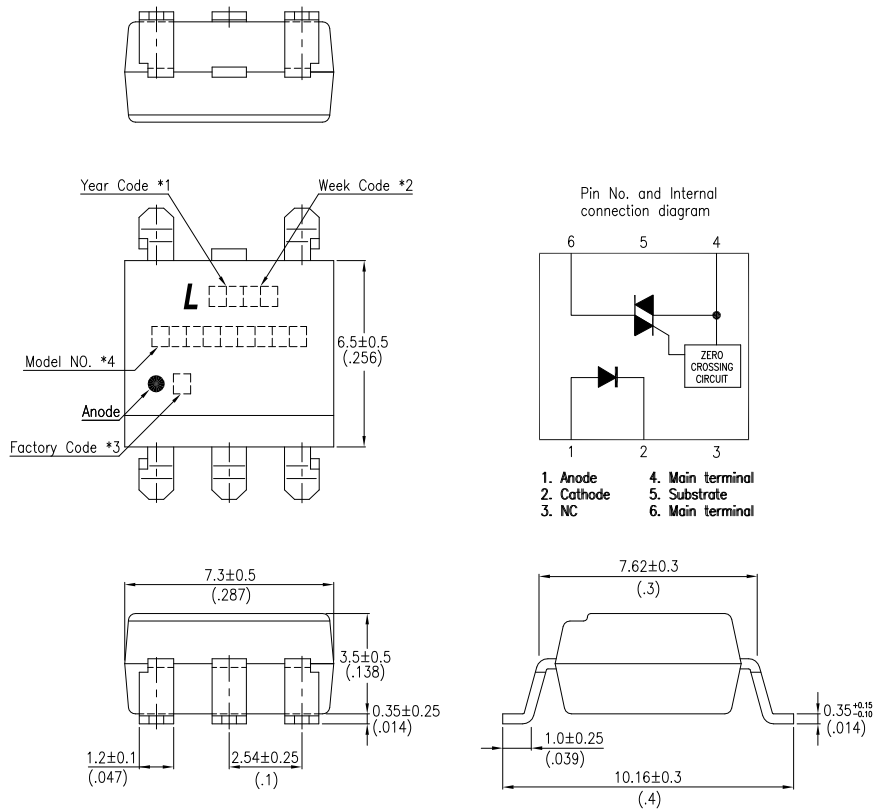

Notes :

1. Year date code.
2. 2-digit work week.
3. Factory identification mark shall be marked (Y: Thailand, W: China-CZ, X: China-TJ).
4. Model No.: MOC3063-A

Photocouplers MOC3063-A SERIES

3. TAPING DIMENSIONS

3.1 MOC3063S-TA-A :

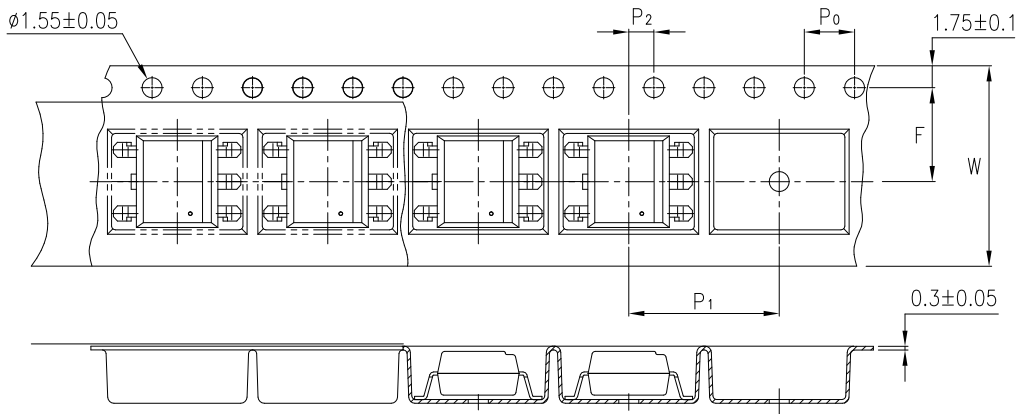

3.2 MOC3063S-TA1-A :

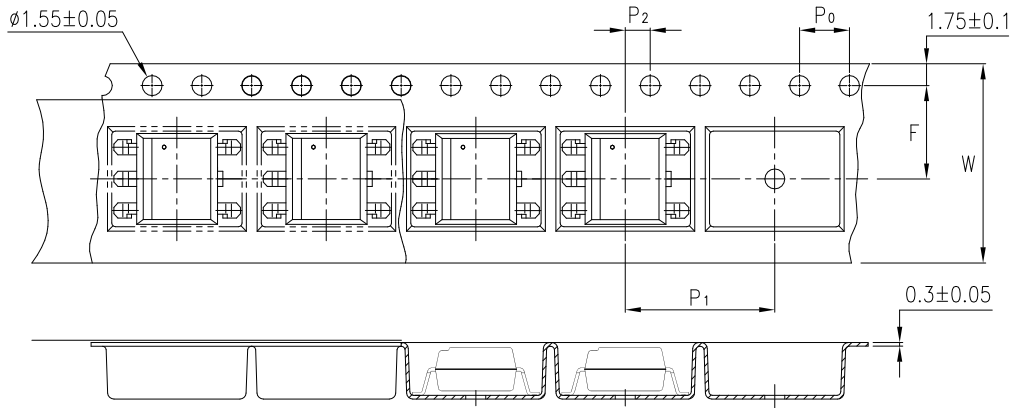

Description	Symbol	Dimension in mm (inch)
Tape wide	W	16±0.3 (0.63)
Pitch of sprocket holes	P ₀	4±0.1 (0.15)
Distance of compartment	F	7.5±0.1 (0.295)
	P ₂	2±0.1 (0.079)
Distance of compartment to compartment	P ₁	12±0.1 (0.472)

Photocouplers MOC3063-A SERIES

4. RATING AND CHARACTERISTICS

4.1 Absolute Maximum Ratings at Ta=25°C

	Parameter	Symbol	Rating	Unit
Input	Forward Current	I_F	50	mA
	Reverse Voltage	V_R	6	V
	Power Dissipation	P_D	120	mW
Output	Off-State Output Terminal Voltage	V_{DRM}	600	V
	Peak Repetitive Surge Current (PW=100μs, 120pps)	I_{TSM}	1	A
	Collector Power Dissipation	P_C	150	mW
Total Power Dissipation		P_{tot}	250	mW
*1 Isolation Voltage		V_{iso}	5,000	V_{rms}
Ambient Operating Temperature Range		T_A	-40 ~ +100	°C
Storage Temperature Range		T_{stg}	-55 ~ +150	°C
*2 Soldering Temperature		T_L	260	°C

*1. AC For 1 Minute, R.H. = 40 ~ 60%

Isolation voltage shall be measured using the following method.

- (1) Short between anode and cathode on the primary side and between collector and emitter on the secondary side.
- (2) The isolation voltage tester with zero-cross circuit shall be used.
- (3) The waveform of applied voltage shall be a sine wave.

*2. For 10 Seconds

Photocouplers MOC3063-A SERIES

4.2 ELECTRICAL OPTICAL CHARACTERISTICS at Ta=25°C

PARAMETER		SYMBOL	MIN.	TYP.	MAX.	UNIT	CONDITIONS
INPUT	Forward Voltage	V _F	—	1.2	1.4	V	I _F =20mA
	Reverse Current	I _R	—	0.05	10	μA	V _R =6V
OUTPUT	*1 Peak Blocking Current, Either Direction	I _{DRM1}	—	—	500	nA	V _{DRM} = 600V
	Peak On-State Voltage, Either Direction	V _{TM}	—	—	3.0	V	I _{TM} =100 mA Peak
	*2 Critical rate of Rise of Off-State Voltage	dv/dt	600	1500	—	V/μs	
COUPLED	*3 Led Trigger Current, Current Required to Latch Output, Either Direction	I _{FT}	—	—	5	mA	Main Terminal Voltage = 3V
	Holding Current, Either Direction	I _H	—	400	—	μA	
	Turn-On Time	T _{ON}	—	8	20	μs	V _P =9V, I _F =20mA R _L = 100Ω
ZERO CROSSING	Inhibit Voltage	V _{INH}	—	5	20	Volts	I _F =Rated I _{FT} , MT1-MT2 Voltage above which device will not trigger.
	Leakage in Inhibited State	I _{DRM2}	—	—	500	μA	I _F = Rated I _{FT} , Rated V _{DRM} , Off State

*1 Test voltage must be applied within dv/dt rating.

*2 This is static dv/dt. Commutating dv/dt is a function of the load-driving thyristor(s) only.

*3 All devices are guaranteed to trigger at an I_F value less than or equal to max I_{FT}. Therefore, recommended operating I_F lies between max I_{FT} 5 mA for MOC3063-A and absolute max I_F (50mA)

Photocouplers MOC3063-A SERIES

5. CHARACTERISTICS CURVES

Fig.1 Forward Current vs. Ambient Temperature

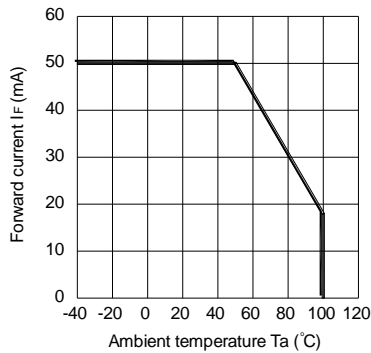

Fig.2 On-state Current vs. Ambient Temperature

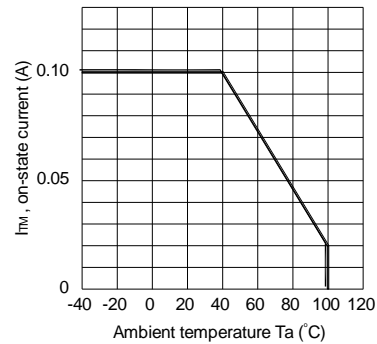

Fig.3 Minimum Trigger Current vs. Ambient Temperature

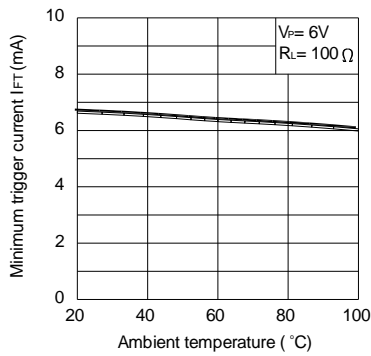

Fig.4 Forward Current vs. Forward Voltage

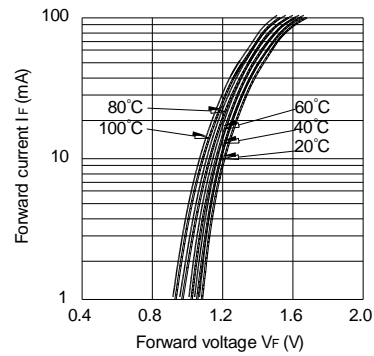

Fig.5 On-state Voltage vs. Ambient Temperature

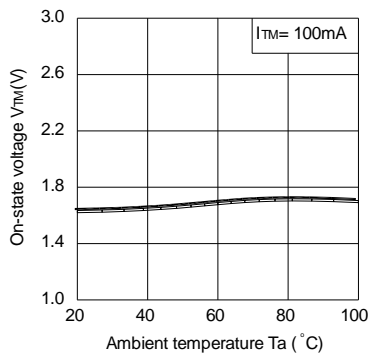
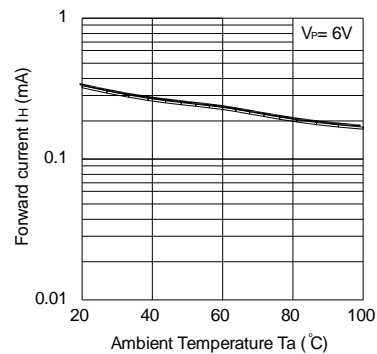

Fig.6 Holding Current vs. Ambient Temperature



Photocouplers MOC3063-A SERIES

Fig. 7 Repetitive Peak Off-state Current vs. Temperature

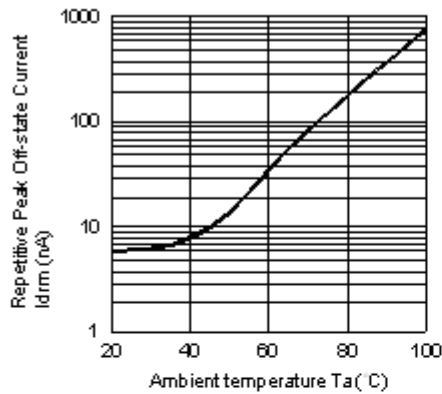
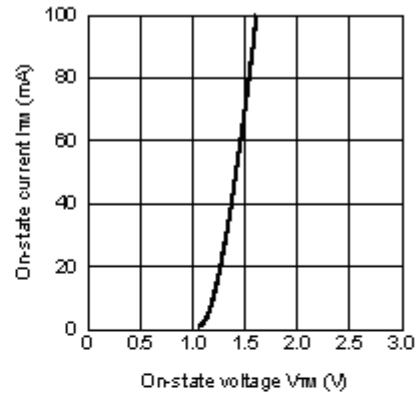
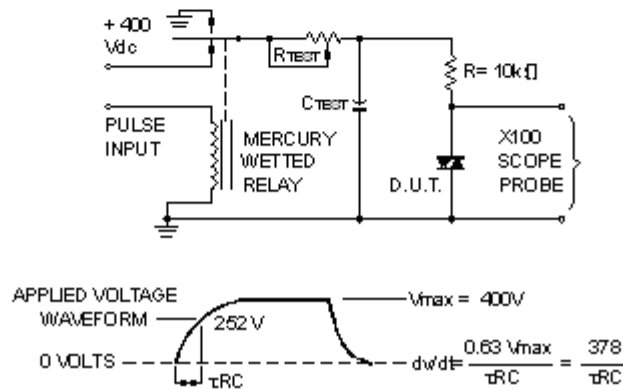

Fig. 8 On-state Current vs. On-state Voltage



Static dv/dt Test Circuit



Photocouplers MOC3063-A SERIES

6. TEMPERATURE PROFILE OF SOLDERING

6.1 IR Reflow soldering (JEDEC-STD-020C compliant)

One time soldering reflow is recommended within the condition of temperature and time profile shown below. Do not solder more than three times.

Profile item	Conditions
Preheat	
- Temperature Min (T_{Smin})	150°C
- Temperature Max (T_{Smax})	200°C
- Time (min to max) (ts)	90±30 sec
Soldering zone	
- Temperature (T_L)	217°C
- Time (t_L)	60 sec
Peak Temperature (T_P)	260°C
Ramp-up rate	3°C / sec max.
Ramp-down rate	3~6°C / sec

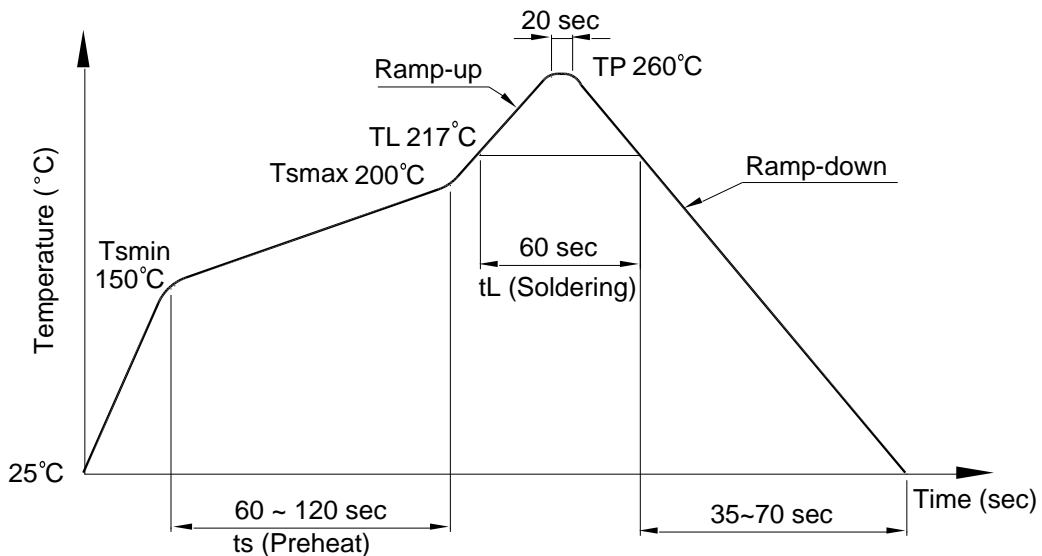

Photocouplers MOC3063-A SERIES

6.2 Wave soldering (JEDEC22A111 compliant)

One time soldering is recommended within the condition of temperature.

Temperature: $260 \pm 0 / -5^{\circ}\text{C}$

Time: 10 sec.

Preheat temperature: 25 to 140°C

Preheat time: 30 to 80 sec.

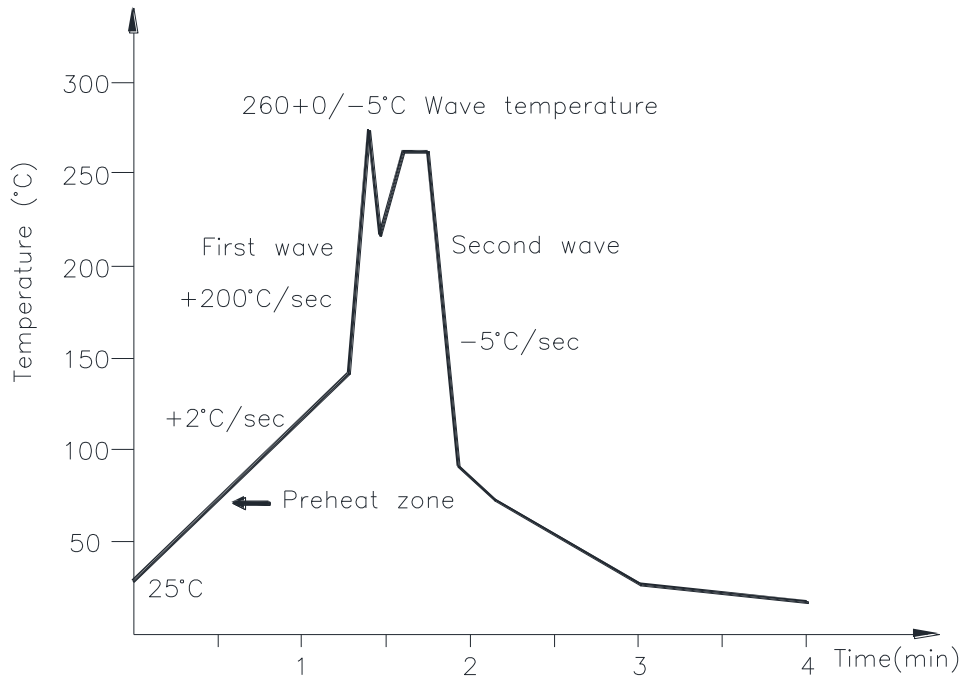

6.3 Hand soldering by soldering iron

Allow single lead soldering in every single process. One time soldering is recommended.

Temperature: $380 \pm 0 / -5^{\circ}\text{C}$

Time: 3 sec max.

Photocouplers MOC3063-A SERIES

7. RRECOMMENDED FOOT PRINT PATTERNS (MOUNT PAD)

Unit: mm

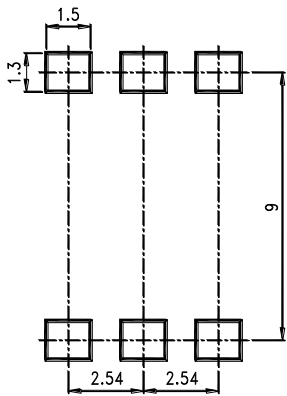

8. NAMING RULE

MOC3063(1)(2)-(A)

DEVICE PART NUMBER

(1)= FORM TYPE (S, M or none)

(2)= TAPING TYPE (TA, TA1 or none)

A = Cut Pin 5

9. Notes:

- LiteOn is continually improving the quality, reliability, function or design and LiteOn reserves the right to make changes without further notices.
- The products shown in this publication are designed for the general use in electronic applications such as office automation equipment, communications devices, audio/visual equipment, electrical application and instrumentation.
- For equipment/devices where high reliability or safety is required, such as space applications, nuclear power control equipment, medical equipment, etc, please contact our sales representatives.
- When requiring a device for any "specific" application, please contact our sales in advice.
- If there are any questions about the contents of this publication, please contact us at your convenience.
- The contents described herein are subject to change without prior notice.
- Immerge unit's body in solder paste is not recommended.