

LDE, Unencapsulated Stacked Chip, Size 1206 – 6054, 50 – 1,000 VDC (Automotive Grade)

Overview

Polyethylene naphthalate (PEN) film capacitor for surface mounting, which meets the demanding Automotive Electronics Council's AEC-Q200 qualification requirements.

Applications

Typical applications include filtering, timing, bypassing, and coupling. LDE is a general purpose series designed for the highest reliability and high temperature service. Not suitable for across-the-line application (see suppressor capacitors).

Benefits

- Rated voltage: 50 – 1,000 VDC
- Rated voltage: 40 – 250 VAC
- Capacitance range: 0.001 – 4.7 μ F
- EIA Size: 1206 – 6054
- Capacitance tolerance: \pm 10%, \pm 20%, \pm 5% on request
- Climatic category: 55/125/56
- RoHS Compliant and lead-free terminations
- Operating temperature range of -55°C to $+125^{\circ}\text{C}$
- Automotive (AEC-Q200) grades available

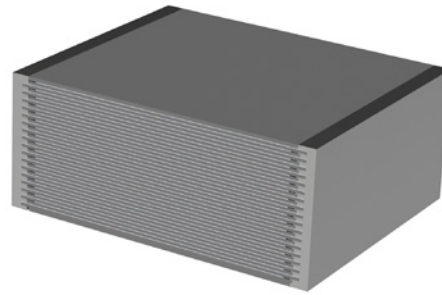

Part Number System

| LDE | C | C | 2560 | M | A | 5 | N | 00 |
|----------------|---|---------------------|--|---|------------|-------------------------------|----------------------------|---------------|
| Series | Rated Voltage (VDC) | Size Code | Capacitance Code (pF) | Capacitance Tolerance | Dielectric | Version | Packaging | Internal Use |
| Metallized PEN | C = 50 D = 63 E = 100 I = 250 M = 400 P = 630 Q = 1,000 | See Dimension Table | Digits two – four indicate the first three digits of the capacitance value. First digit indicates the number of zeros to be added. | K = \pm 10% M = \pm 20% J = \pm 5% on request | A = PEN | 5 = Standard 0 = Miniature | See Ordering Options Table | 00 (Standard) |

Dimensions – Millimeters

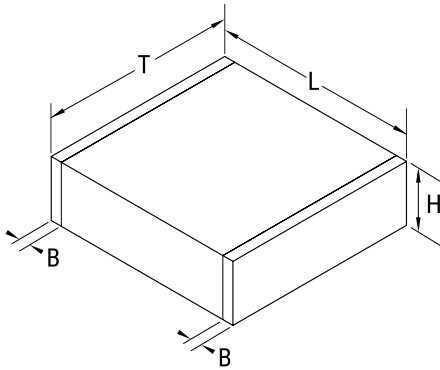

| Size Code | Chip Size (EIA) | T | | H (Maximum) | L | | B | |
|-----------|-----------------|---------|-----------|-----------------------|---------|-----------|---------|-----------|
| | | Nominal | Tolerance | | Nominal | Tolerance | Nominal | Tolerance |
| A | 1206 | 1.7 | ±0.2 | See Part Number Table | 3.3 | +0.3/-0.1 | 0.5 | +0.5/-0.3 |
| B | 1210 | 2.5 | ±0.3 | | 3.3 | +0.3/-0.1 | 0.5 | +0.5/-0.3 |
| C | 1812 | 3.3 | ±0.3 | | 4.7 | +0.3/-0.2 | 0.5 | +0.5/-0.3 |
| D | 2220 | 5.0 | ±0.4 | | 6.0 | ±0.3 | 0.5 | +0.5/-0.3 |
| E | 2824 | 6.1 | ±0.4 | | 7.3 | ±0.4 | 0.5 | +0.5/-0.3 |
| F | 4030 | 7.9 | ±0.5 | | 10.5 | ±0.4 | 0.5 | +0.5/-0.3 |
| G | 5040 | 10.4 | ±0.5 | | 13.0 | ±0.4 | 0.5 | +0.5/-0.3 |
| H | 6054 | 13.7 | ±0.5 | | 15.5 | +0.4/-0.9 | 0.5 | +0.5/-0.3 |

Landing Areas and Solder Paste Suggestions

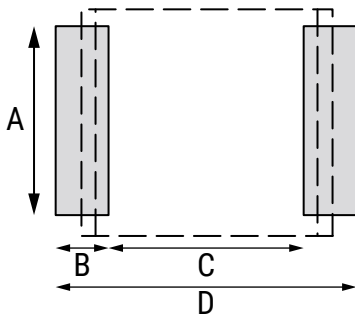

| Size | Dimensions in mm | | | | Size | Dimensions in mm | | | |
|------|------------------|-----|-----|-----|------|------------------|-----|------|------|
| | A | B | C | D | | A | B | C | D |
| 1206 | 1.5 | 1.1 | 2.3 | 4.5 | 2824 | 5.7 | 2.3 | 5.3 | 9.9 |
| 1210 | 2.3 | 1.1 | 2.3 | 4.5 | 4030 | 7.4 | 2.6 | 8.2 | 13.4 |
| 1812 | 3.0 | 1.7 | 3.1 | 6.5 | 5040 | 9.6 | 2.6 | 10.7 | 15.9 |
| 2220 | 4.6 | 2.1 | 3.9 | 8.1 | 6054 | 12.6 | 2.6 | 13.2 | 18.4 |

These landing area dimensions have the aim of taking full advantage of the new RoHS 6 terminations design.

We suggest to use a Sn/Ag/Cu solder paste (suggested thickness: 0.10 – 0.15 mm).

If a NOT Lead Free solder paste is used, a minimum peak temperature of 210°C on the component's body is suggested.

Ordering Options Table

| Packaging Type | Packaging Code |
|-----------------------------------|----------------|
| Standard Packaging Options | |
| Tape and Reel (Standard Reel) | N |

Performance Characteristics

| | | | | | | | |
|--------------------------------------|--|-------------|-------------|-------------|--------------|--------------|-------------|
| Rated Voltage (VDC) | 50 | 63 | 100 | 250 | 400 | 630 | 1,000 |
| Rated Voltage (VAC) | 40 | 40 | 63 | 120 | 160 | 200 | 250 |
| Capacitance Range (µF) | 0.001 – 4.7 | 0.001 – 4.7 | 0.001 – 4.7 | 0.001 – 1.5 | 0.015 – 0.47 | 0.001 – 0.27 | 0.001 – 0.1 |
| Chip Size (EIA) | 1206 – 6054 | | | | | | |
| Capacitance Values | E12 series | | | | | | |
| Capacitance Tolerance | ±10%, ±20%, ±5% on request | | | | | | |
| Category Temperature Range | –55°C to +125°C | | | | | | |
| Rated Temperature | +105°C | | | | | | |
| Voltage Derating | V_c (category voltage) = V_R (rated voltage) up to 105°C. V_c is decreased with 1.25%/°C from +105°C to +125°C | | | | | | |
| Climatic Category | 55/125/56 | | | | | | |
| Capacitance Drift | Maximum 3% (sizes ≤ 22.20) after a 2 year storage period at a temperature of +10°C to +40°C and a relative humidity of 40% to 60% Maximum 2% (sizes > 22.20) after a 2 year storage period at a temperature of +10°C to +40°C and a relative humidity of 40% to 60% | | | | | | |
| Reliability (Reference IEC 61709) | Failure rate ≤ 1 FIT, T = +40°C, V = 0.5 x V_R 1 FIT = 10 ⁻⁹ failures / (components * hours) Failure criteria: open or short circuit, cap. change > 10%, DF 2 times the catalog limits, IR < 0.005 x initial limit | | | | | | |
| Insulation Resistance | Measured at +25°C ±5°C | | | | | | |
| | Minimum Value Between Terminals | | | | | | |
| | C ≤ 0.33 µF | | | 1,000 MΩ | | | |
| | C > 0.33 µF | | | 400 MΩ · µF | | | |
| Dissipation Factor | Charging time: 1 minute Charging voltage: 10 VDC for $V_R < 100$ VDC 100 VDC for $V_R ≥ 100$ VDC | | | | | | |
| | Maximum Values at 25°C ±5°C | | | | | | |
| Surge Voltage Test | 1 kHz | | | 0.8% | | | |
| | 1.4 x V_R (2 seconds; T = 25 ± 5°C) for $V_R ≤ 630 V_{DC}$ 1.5 x V_R (2 seconds; T = 25 ± 5°C) for $V_R = 1,000 V_{DC}$ | | | | | | |
| Maximum dv/dt | 100 V/us for $V_R ≤ 630$ VDC | | | | | | |
| | 300 V/us for $V_R = 1,000$ VDC | | | | | | |

Maximum Voltage (V_{rms}) Versus Frequency (Sinusoidal Waveform/ $Th \leq 85^\circ C$)

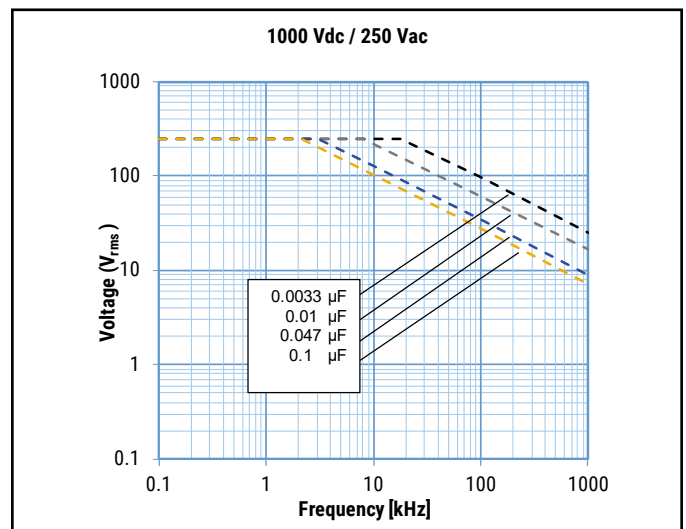
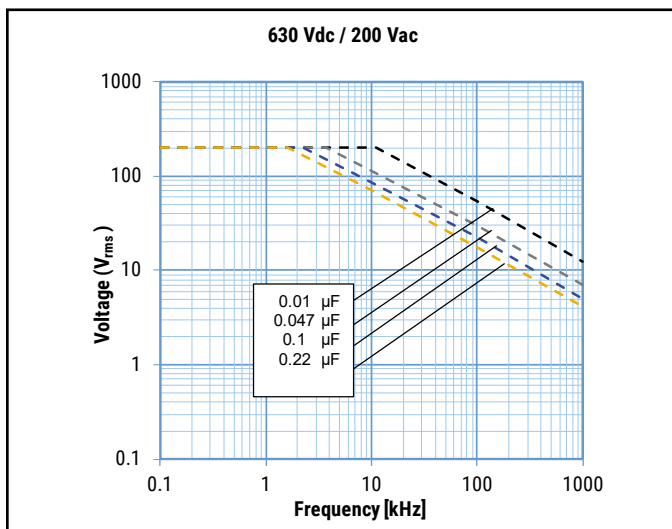
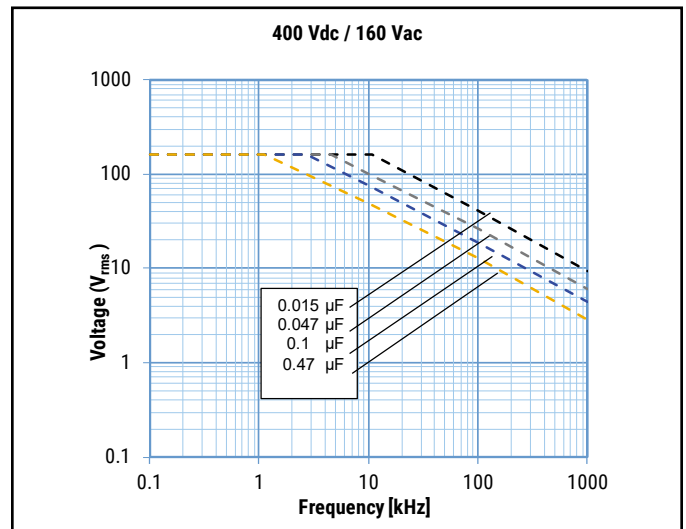
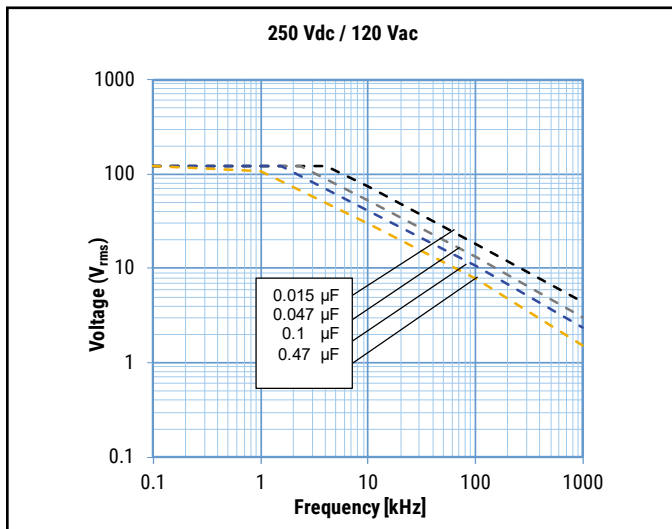
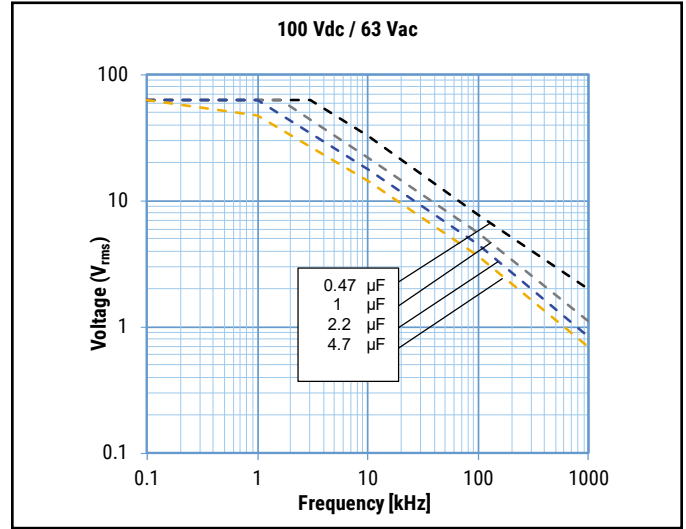
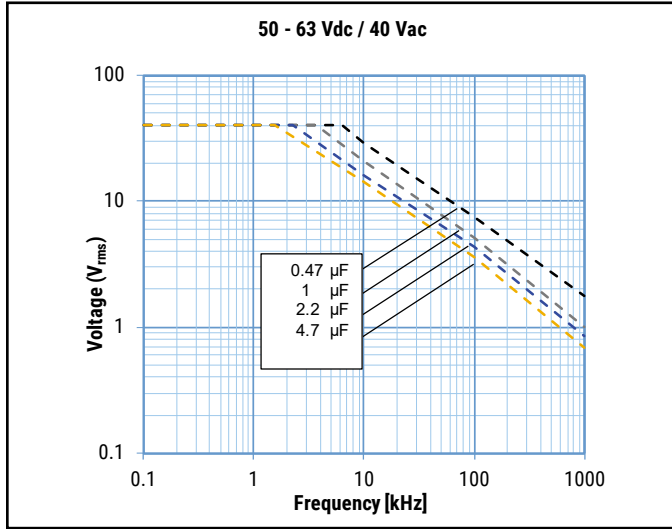

Maximum Current (I_{rms}) Versus Frequency (Sinusoidal Waveform/ $Th \leq 85^\circ C$)

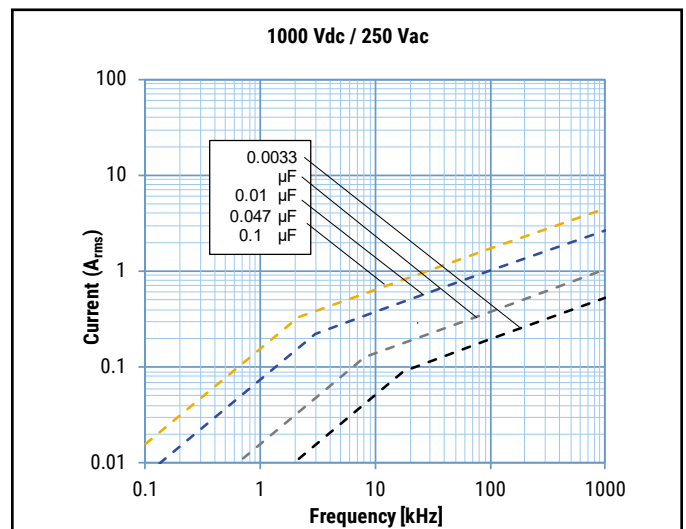
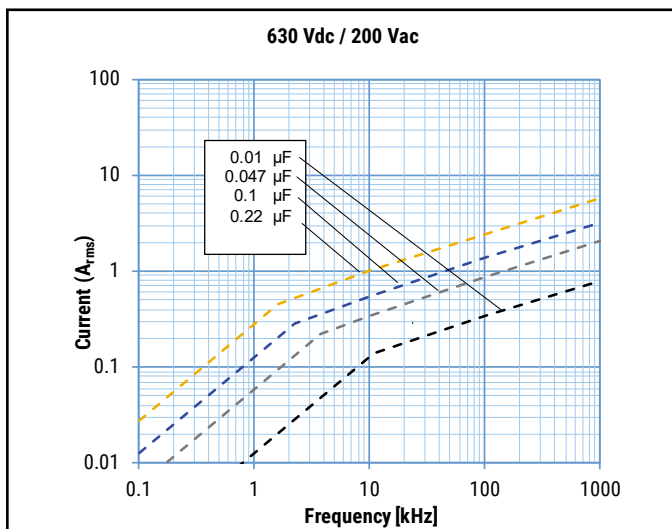
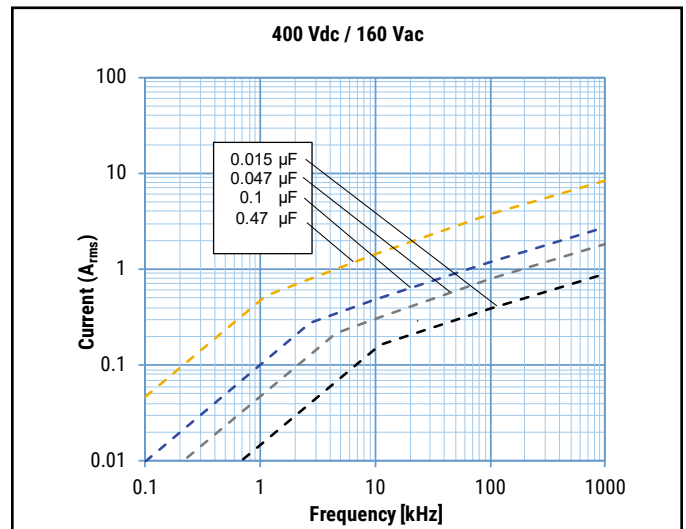
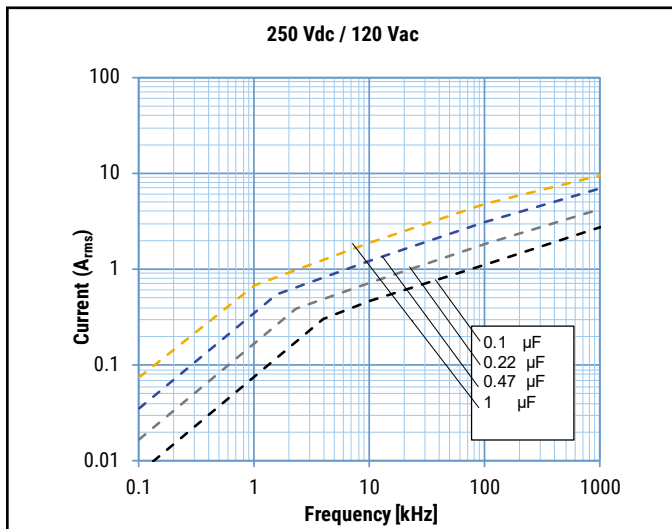
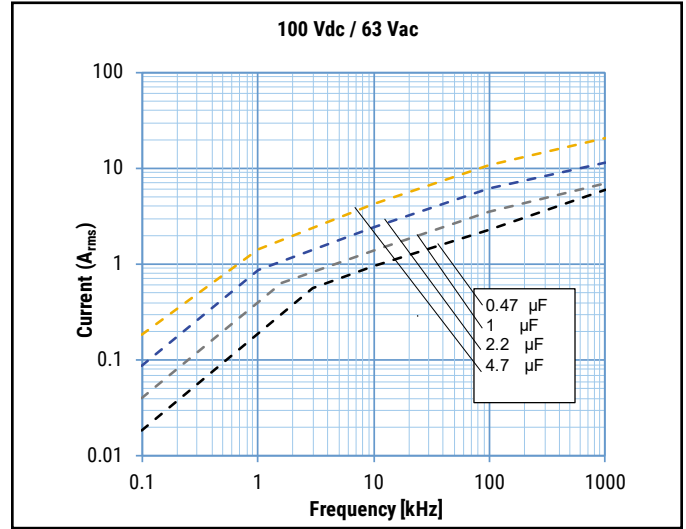
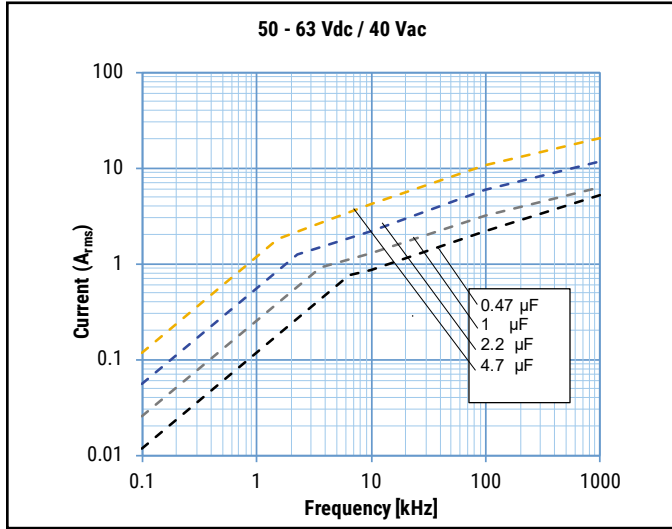

PEN Dielectric Typical Temperature Graphs

PEN Dielectric Typical Frequency Graphs

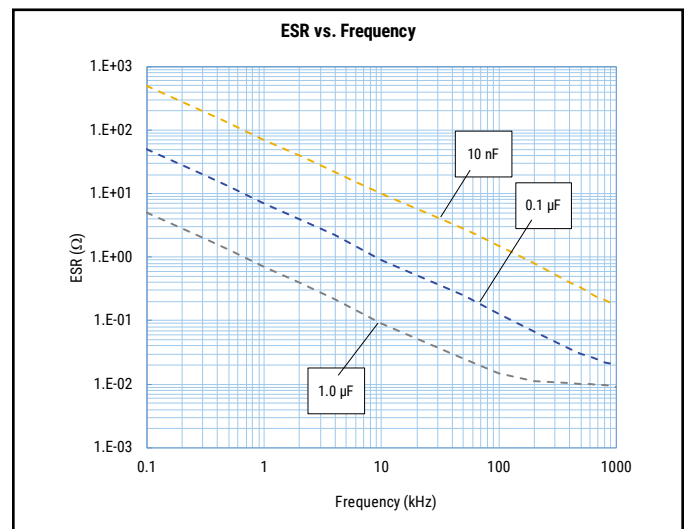
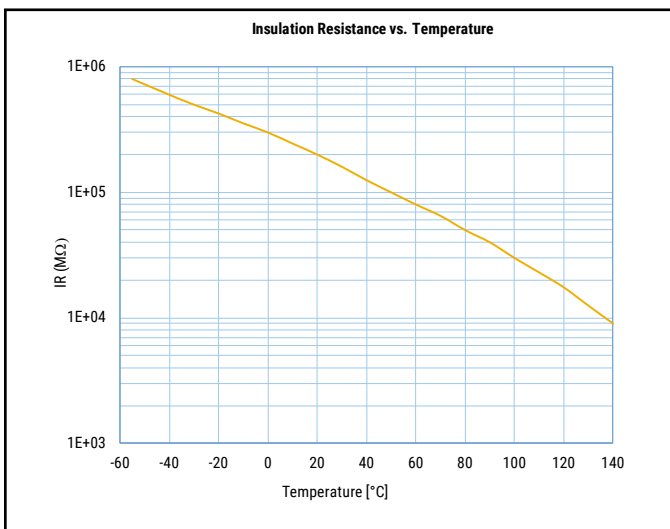
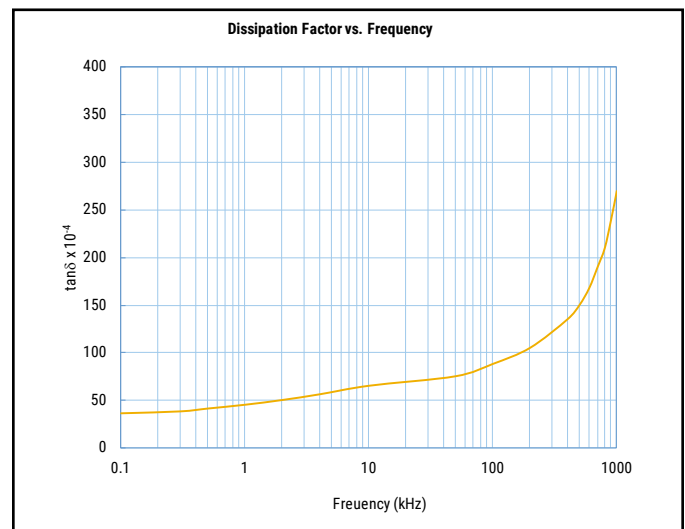
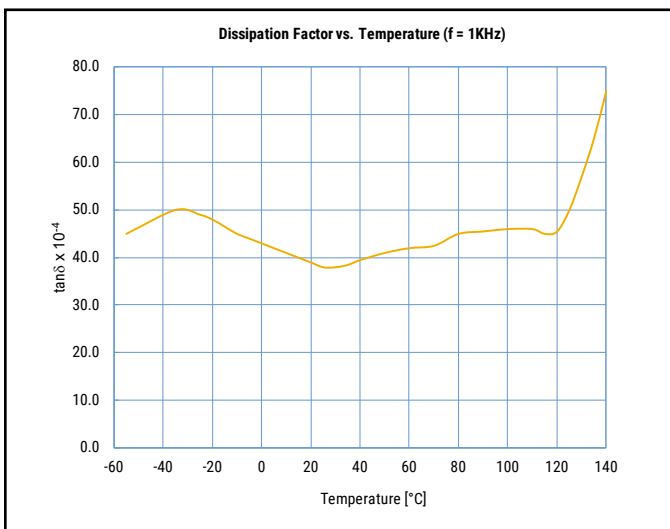
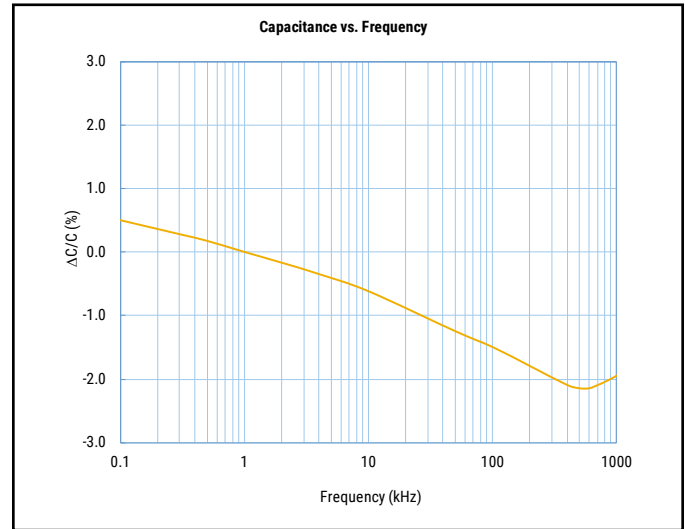
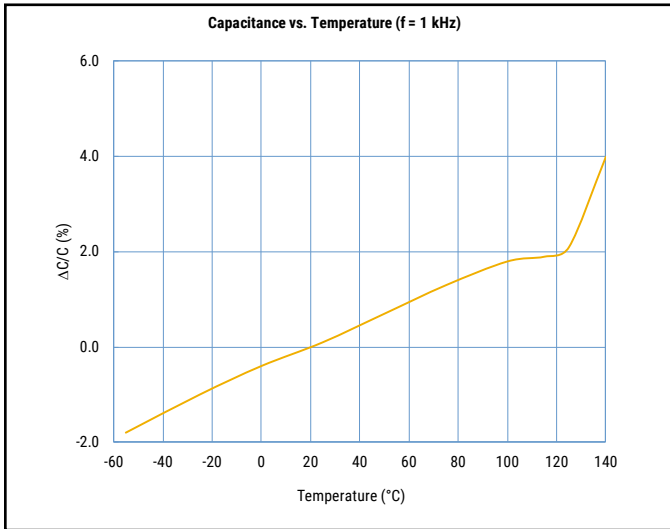

PEN and PPS Impedance vs. Frequency

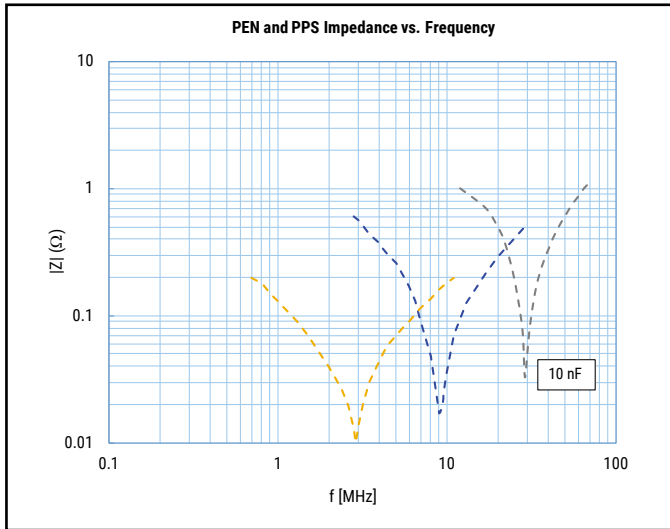

Qualification

Automotive grade products meet or exceed the requirements outlined by the Automotive Electronics Council. Details regarding test methods and conditions that are referenced in the document AEC-Q200, Stress Test Qualification for Passive Components. For additional information regarding the Automotive Electronics Council and AEC-Q200, please visit their website at www.aecouncil.com.

Environmental Compliance

All KEMET surface mount capacitors are RoHS Compliant.



Environmental Test Data

| Damp Heat, Steady State | |
|------------------------------------|--------------------------------------|
| Test Conditions | |
| Temperature | +40°C ±2°C |
| Relative Humidity (RH) | 93% ±2% |
| Test Duration | 56 days |
| Performance | |
| Capacitance Change Δ C/C | ≤ 7% |
| DF Change (Δtgδ) | ≤ 50 x 10 ⁻⁴ at 1 kHz |
| Insulation Resistance | ≥ 50% of limit value |
| Endurance | |
| Test Conditions | |
| Temperature | 125°C ±2°C |
| Test Duration | 2,000 hours |
| Voltage Applied | 1.25 x V _C |
| Performance | |
| Capacitance Change Δ C/C | ≤ 5% |
| DF Change (Δtgδ) | ≤ 50 x 10 ⁻⁴ at 1 kHz |
| Insulation Resistance | ≥ 50% of limit value |
| Rapid Change of Temperature | |
| Test Conditions | |
| Temperature | 1 hour at -55°C, 1 hour at +125°C |
| Number of Cycles | 1,000 |
| Performance | |
| Capacitance Change Δ C/C | ≤ 5% |
| DF Change (Δtgδ) | ≤ 50 x 10 ⁻⁴ at 1 kHz |
| Insulation Resistance | ≥ limit value |
| No Mechanical Damage | |

| Reflow | |
|---|----------------------------------|
| Test Conditions | See Solder Process |
| Performance | |
| Capacitance Change Δ C/C | ≤ 3% |
| DF Change (Δtgδ) | ≤ 50 x 10 ⁻⁴ at 1 kHz |
| Insulation Resistance | ≥ limit value |
| No Mechanical Damage | |
| Bending | |
| Test Conditions | |
| Deflection | 1 – 6 mm |
| Performance | |
| Capacitance Change Δ C/C | ≤ 1% |
| No visible damage on the terminations (peeling) neither on the body (cracking) | |

Table 1 – Ratings & Part Number Reference

| VDC | VAC | Capacitance Value (µF) | Size Code | Chip Size | Dimensions in mm | | | dV/dt (V/µs) | New KEMET Part Number | Legacy Part Number |
|-----|-----|------------------------|-----------|-----------|------------------|---------|--------|--------------|-----------------------|--------------------|
| | | | | | W | H (max) | L | | | |
| 50 | 40 | 0.001 | A | 1206 | 1.7 | 1.1 | 3.3 | 100 | DECA1100(1)A0N00 | LDECA1100(1)A0N00 |
| 50 | 40 | 0.0012 | A | 1206 | 1.7 | 1.1 | 3.3 | 100 | DECA1120(1)A0N00 | LDECA1120(1)A0N00 |
| 50 | 40 | 0.0015 | C | 1812 | 3.3 | 1.7 | 4.7 | 100 | DECC1150(1)A5N00 | LDECC1150(1)A5N00 |
| 50 | 40 | 0.0015 | A | 1206 | 1.7 | 1.1 | 3.3 | 100 | DECA1150(1)A0N00 | LDECA1150(1)A0N00 |
| 50 | 40 | 0.0018 | C | 1812 | 3.3 | 1.7 | 4.7 | 100 | DECC1180(1)A5N00 | LDECC1180(1)A5N00 |
| 50 | 40 | 0.0018 | A | 1206 | 1.7 | 1.1 | 3.3 | 100 | DECA1180(1)A0N00 | LDECA1180(1)A0N00 |
| 50 | 40 | 0.0022 | C | 1812 | 3.3 | 1.7 | 4.7 | 100 | DECC1220(1)A5N00 | LDECC1220(1)A5N00 |
| 50 | 40 | 0.0022 | A | 1206 | 1.7 | 1.1 | 3.3 | 100 | DECA1220(1)A0N00 | LDECA1220(1)A0N00 |
| 50 | 40 | 0.0027 | C | 1812 | 3.3 | 1.8 | 4.7 | 100 | DECC1270(1)A5N00 | LDECC1270(1)A5N00 |
| 50 | 40 | 0.0027 | A | 1206 | 1.7 | 1.1 | 3.3 | 100 | DECA1270(1)A0N00 | LDECA1270(1)A0N00 |
| 50 | 40 | 0.0033 | C | 1812 | 3.3 | 1.7 | 4.7 | 100 | DECC1330(1)A5N00 | LDECC1330(1)A5N00 |
| 50 | 40 | 0.0033 | A | 1206 | 1.7 | 1.2 | 3.3 | 100 | DECA1330(1)A0N00 | LDECA1330(1)A0N00 |
| 50 | 40 | 0.0039 | C | 1812 | 3.3 | 1.7 | 4.7 | 100 | DECC1390(1)A5N00 | LDECC1390(1)A5N00 |
| 50 | 40 | 0.0039 | A | 1206 | 1.7 | 1.1 | 3.3 | 100 | DECA1390(1)A0N00 | LDECA1390(1)A0N00 |
| 50 | 40 | 0.0047 | C | 1812 | 3.3 | 1.8 | 4.7 | 100 | DECC1470(1)A5N00 | LDECC1470(1)A5N00 |
| 50 | 40 | 0.0047 | A | 1206 | 1.7 | 1.1 | 3.3 | 100 | DECA1470(1)A0N00 | LDECA1470(1)A0N00 |
| 50 | 40 | 0.0056 | C | 1812 | 3.3 | 1.7 | 4.7 | 100 | DECC1560(1)A5N00 | LDECC1560(1)A5N00 |
| 50 | 40 | 0.0056 | A | 1206 | 1.7 | 1.1 | 3.3 | 100 | DECA1560(1)A0N00 | LDECA1560(1)A0N00 |
| 50 | 40 | 0.0068 | C | 1812 | 3.3 | 1.7 | 4.7 | 100 | DECC1680(1)A5N00 | LDECC1680(1)A5N00 |
| 50 | 40 | 0.0068 | A | 1206 | 1.7 | 1.1 | 3.3 | 100 | DECA1680(1)A0N00 | LDECA1680(1)A0N00 |
| 50 | 40 | 0.0082 | C | 1812 | 3.3 | 1.8 | 4.7 | 100 | DECC1820(1)A5N00 | LDECC1820(1)A5N00 |
| 50 | 40 | 0.0082 | A | 1206 | 1.7 | 1.1 | 3.3 | 100 | DECA1820(1)A0N00 | LDECA1820(1)A0N00 |
| 50 | 40 | 0.01 | C | 1812 | 3.3 | 1.7 | 4.7 | 100 | DECC2100(1)A5N00 | LDECC2100(1)A5N00 |
| 50 | 40 | 0.01 | A | 1206 | 1.7 | 1.1 | 3.3 | 100 | DECA2100(1)A0N00 | LDECA2100(1)A0N00 |
| 50 | 40 | 0.012 | C | 1812 | 3.3 | 1.7 | 4.7 | 100 | DECC2120(1)A5N00 | LDECC2120(1)A5N00 |
| 50 | 40 | 0.012 | A | 1206 | 1.7 | 1.1 | 3.3 | 100 | DECA2120(1)A0N00 | LDECA2120(1)A0N00 |
| 50 | 40 | 0.015 | C | 1812 | 3.3 | 1.7 | 4.7 | 100 | DECC2150(1)A5N00 | LDECC2150(1)A5N00 |
| 50 | 40 | 0.015 | A | 1206 | 1.7 | 1.2 | 3.3 | 100 | DECA2150(1)A0N00 | LDECA2150(1)A0N00 |
| 50 | 40 | 0.018 | C | 1812 | 3.3 | 1.8 | 4.7 | 100 | DECC2180(1)A5N00 | LDECC2180(1)A5N00 |
| 50 | 40 | 0.018 | A | 1206 | 1.7 | 1.1 | 3.3 | 100 | DECA2180(1)A0N00 | LDECA2180(1)A0N00 |
| 50 | 40 | 0.022 | C | 1812 | 3.3 | 1.7 | 4.7 | 100 | DECC2220(1)A5N00 | LDECC2220(1)A5N00 |
| 50 | 40 | 0.022 | A | 1206 | 1.7 | 1.1 | 3.3 | 100 | DECA2220(1)A0N00 | LDECA2220(1)A0N00 |
| 50 | 40 | 0.027 | C | 1812 | 3.3 | 1.7 | 4.7 | 100 | DECC2270(1)A5N00 | LDECC2270(1)A5N00 |
| 50 | 40 | 0.027 | A | 1206 | 1.7 | 1.1 | 3.3 | 100 | DECA2270(1)A0N00 | LDECA2270(1)A0N00 |
| 50 | 40 | 0.033 | C | 1812 | 3.3 | 1.8 | 4.7 | 100 | DECC2330(1)A5N00 | LDECC2330(1)A5N00 |
| 50 | 40 | 0.033 | B | 1210 | 2.5 | 2.0 | 3.3 | 100 | DECB2330(1)A0N00 | LDECB2330(1)A0N00 |
| 50 | 40 | 0.033 | A | 1206 | 1.7 | 1.2 | 3.3 | 100 | DECA2330(2)A0N00 | LDECA2330(2)A0N00 |
| 50 | 40 | 0.039 | C | 1812 | 3.3 | 1.7 | 4.7 | 100 | DECC2390(1)A5N00 | LDECC2390(1)A5N00 |
| 50 | 40 | 0.039 | B | 1210 | 2.5 | 2.1 | 3.3 | 100 | DECB2390(1)A0N00 | LDECB2390(1)A0N00 |
| 50 | 40 | 0.047 | C | 1812 | 3.3 | 1.7 | 4.7 | 100 | DECC2470(1)A5N00 | LDECC2470(1)A5N00 |
| 50 | 40 | 0.047 | B | 1210 | 2.5 | 2.1 | 3.3 | 100 | DECB2470(1)A0N00 | LDECB2470(1)A0N00 |
| 50 | 40 | 0.056 | C | 1812 | 3.3 | 1.7 | 4.7 | 100 | DECC2560(1)A5N00 | LDECC2560(1)A5N00 |
| 50 | 40 | 0.056 | B | 1210 | 2.5 | 1.7 | 3.3 | 100 | DECB2560(1)A0N00 | LDECB2560(1)A0N00 |
| 50 | 40 | 0.068 | C | 1812 | 3.3 | 1.8 | 4.7 | 100 | DECC2680(1)A5N00 | LDECC2680(1)A5N00 |
| 50 | 40 | 0.068 | B | 1210 | 2.5 | 2.0 | 3.3 | 100 | DECB2680(1)A0N00 | LDECB2680(1)A0N00 |
| 50 | 40 | 0.082 | C | 1812 | 3.3 | 2.1 | 4.7 | 100 | DECC2820(1)A5N00 | LDECC2820(1)A5N00 |
| 50 | 40 | 0.082 | B | 1210 | 2.5 | 2.1 | 3.3 | 100 | DECB2820(1)A0N00 | LDECB2820(1)A0N00 |
| 50 | 40 | 0.1 | C | 1812 | 3.3 | 2.4 | 4.7 | 100 | DECC3100(1)A5N00 | LDECC3100(1)A5N00 |
| 50 | 40 | 0.1 | B | 1210 | 2.5 | 2.1 | 3.3 | 100 | DECB3100(1)A0N00 | LDECB3100(1)A0N00 |
| 50 | 40 | 0.12 | C | 1812 | 3.3 | 1.7 | 4.7 | 100 | DECC3120(1)A5N00 | LDECC3120(1)A5N00 |
| 50 | 40 | 0.15 | C | 1812 | 3.3 | 1.9 | 4.7 | 100 | DECC3150(1)A5N00 | LDECC3150(1)A5N00 |
| 50 | 40 | 0.18 | C | 1812 | 3.3 | 2.2 | 4.7 | 100 | DECC3180(1)A5N00 | LDECC3180(1)A5N00 |
| 50 | 40 | 0.22 | C | 1812 | 3.3 | 2.4 | 4.7 | 100 | DECC3220(1)A5N00 | LDECC3220(1)A5N00 |
| 50 | 40 | 0.27 | D | 2220 | 5.0 | 1.9 | 6.0 | 100 | DECD3270(1)A5N00 | LDECD3270(1)A5N00 |
| 50 | 40 | 0.33 | D | 2220 | 5.0 | 1.9 | 6.0 | 100 | DECD3330(1)A5N00 | LDECD3330(1)A5N00 |
| 50 | 40 | 0.39 | D | 2220 | 5.0 | 2.1 | 6.0 | 100 | DECD3390(1)A5N00 | LDECD3390(1)A5N00 |
| 50 | 40 | 0.47 | D | 2220 | 5.0 | 2.4 | 6.0 | 100 | DECD3470(1)A5N00 | LDECD3470(1)A5N00 |
| 50 | 40 | 0.56 | D | 2220 | 5.0 | 2.8 | 6.0 | 100 | DECD3560(1)A5N00 | LDECD3560(1)A5N00 |
| 50 | 40 | 0.68 | D | 2220 | 5.0 | 3.3 | 6.0 | 100 | DECD3680(1)A5N00 | LDECD3680(1)A5N00 |
| VDC | VAC | Capacitance Value (µF) | Size Code | Chip Size | W (mm) | H (mm) | L (mm) | dV/dt (V/µs) | New KEMET Part Number | Legacy Part Number |

(1) K = ±10%, M = ±20%, J = ±5% on request.

(2) Only K and M tolerances available.

Table 1 – Ratings & Part Number Reference cont.

| VDC | VAC | Capacitance Value (µF) | Size Code | Chip Size | Dimensions in mm | | | dV/dt (V/µs) | New KEMET Part Number | Legacy Part Number |
|-----|-----|------------------------|-----------|-----------|------------------|---------|--------|--------------|-----------------------|--------------------|
| | | | | | W | H (max) | L | | | |
| 50 | 40 | 0.82 | E | 2824 | 6.1 | 2.9 | 7.3 | 100 | DECE3820(1)A5N00 | LDECE3820(1)A5N00 |
| 50 | 40 | 0.82 | D | 2220 | 5.0 | 3.7 | 6.0 | 100 | DECD3820(1)A0N00 | LDECD3820(1)A0N00 |
| 50 | 40 | 1.0 | E | 2824 | 6.1 | 3.1 | 7.3 | 100 | DECE4100(1)A5N00 | LDECE4100(1)A5N00 |
| 50 | 40 | 1.0 | D | 2220 | 5.0 | 4.4 | 6.0 | 100 | DECD4100(1)A0N00 | LDECD4100(1)A0N00 |
| 50 | 40 | 1.2 | E | 2824 | 6.1 | 3.6 | 7.3 | 100 | DECE4120(1)A5N00 | LDECE4120(1)A5N00 |
| 50 | 40 | 1.5 | G | 5040 | 10.4 | 3.1 | 13.0 | 100 | DECG4150(1)A5N00 | LDECG4150(1)A5N00 |
| 50 | 40 | 1.5 | E | 2824 | 6.1 | 4.3 | 7.3 | 100 | DECE4150(1)A0N00 | LDECE4150(1)A0N00 |
| 50 | 40 | 1.8 | G | 5040 | 10.4 | 3.4 | 13.0 | 100 | DECG4180(1)A5N00 | LDECG4180(1)A5N00 |
| 50 | 40 | 1.8 | E | 2824 | 6.1 | 5.1 | 7.3 | 100 | DECE4180(1)A0N00 | LDECE4180(1)A0N00 |
| 50 | 40 | 2.2 | G | 5040 | 10.4 | 4.1 | 13.0 | 100 | DECG4220(1)A5N00 | LDECG4220(1)A5N00 |
| 50 | 40 | 2.2 | F | 4030 | 7.9 | 3.3 | 10.5 | 100 | DECF4220(1)A0N00 | LDECF4220(1)A0N00 |
| 50 | 40 | 2.7 | G | 5040 | 10.4 | 4.9 | 13.0 | 100 | DECG4270(1)A5N00 | LDECG4270(1)A5N00 |
| 50 | 40 | 2.7 | F | 4030 | 7.9 | 4.0 | 10.5 | 100 | DECF4270(1)A0N00 | LDECF4270(1)A0N00 |
| 50 | 40 | 3.3 | H | 6054 | 13.7 | 3.9 | 15.5 | 100 | DECH4330(1)A5N00 | LDECH4330(1)A5N00 |
| 50 | 40 | 3.3 | F | 4030 | 7.9 | 4.7 | 10.5 | 100 | DECF4330(1)A0N00 | LDECF4330(1)A0N00 |
| 50 | 40 | 3.9 | H | 6054 | 13.7 | 4.5 | 15.5 | 100 | DECH4390(1)A5N00 | LDECH4390(1)A5N00 |
| 50 | 40 | 3.9 | F | 4030 | 7.9 | 5.5 | 10.5 | 100 | DECF4390(1)A0N00 | LDECF4390(1)A0N00 |
| 50 | 40 | 4.7 | H | 6054 | 13.7 | 5.3 | 15.5 | 100 | DECH4470(1)A5N00 | LDECH4470(1)A5N00 |
| 50 | 40 | 4.7 | G | 5040 | 10.4 | 4.1 | 13.0 | 100 | DECG4470(1)A0N00 | LDECG4470(1)A0N00 |
| 63 | 40 | 0.001 | A | 1206 | 1.7 | 1.1 | 3.3 | 100 | DEDA1100(1)A0N00 | LDEDA1100(1)A0N00 |
| 63 | 40 | 0.0012 | A | 1206 | 1.7 | 1.1 | 3.3 | 100 | DEDA1120(1)A0N00 | LDEDA1120(1)A0N00 |
| 63 | 40 | 0.0015 | C | 1812 | 3.3 | 1.7 | 4.7 | 100 | DEDC1150(1)A5N00 | LDEDC1150(1)A5N00 |
| 63 | 40 | 0.0015 | A | 1206 | 1.7 | 1.1 | 3.3 | 100 | DEDA1150(1)A0N00 | LDEDA1150(1)A0N00 |
| 63 | 40 | 0.0018 | C | 1812 | 3.3 | 1.7 | 4.7 | 100 | DEDC1180(1)A5N00 | LDEDC1180(1)A5N00 |
| 63 | 40 | 0.0018 | A | 1206 | 1.7 | 1.1 | 3.3 | 100 | DEDA1180(1)A0N00 | LDEDA1180(1)A0N00 |
| 63 | 40 | 0.0022 | C | 1812 | 3.3 | 1.7 | 4.7 | 100 | DEDC1220(1)A5N00 | LDEDC1220(1)A5N00 |
| 63 | 40 | 0.0022 | A | 1206 | 1.7 | 1.1 | 3.3 | 100 | DEDA1220(1)A0N00 | LDEDA1220(1)A0N00 |
| 63 | 40 | 0.0027 | C | 1812 | 3.3 | 1.8 | 4.7 | 100 | DEDC1270(1)A5N00 | LDEDC1270(1)A5N00 |
| 63 | 40 | 0.0027 | A | 1206 | 1.7 | 1.1 | 3.3 | 100 | DEDA1270(1)A0N00 | LDEDA1270(1)A0N00 |
| 63 | 40 | 0.0033 | C | 1812 | 3.3 | 1.7 | 4.7 | 100 | DEDC1330(1)A5N00 | LDEDC1330(1)A5N00 |
| 63 | 40 | 0.0033 | A | 1206 | 1.7 | 1.2 | 3.3 | 100 | DEDA1330(1)A0N00 | LDEDA1330(1)A0N00 |
| 63 | 40 | 0.0039 | C | 1812 | 3.3 | 1.7 | 4.7 | 100 | DEDC1390(1)A5N00 | LDEDC1390(1)A5N00 |
| 63 | 40 | 0.0039 | A | 1206 | 1.7 | 1.1 | 3.3 | 100 | DEDA1390(1)A0N00 | LDEDA1390(1)A0N00 |
| 63 | 40 | 0.0047 | C | 1812 | 3.3 | 1.8 | 4.7 | 100 | DEDC1470(1)A5N00 | LDEDC1470(1)A5N00 |
| 63 | 40 | 0.0047 | A | 1206 | 1.7 | 1.1 | 3.3 | 100 | DEDA1470(1)A0N00 | LDEDA1470(1)A0N00 |
| 63 | 40 | 0.0056 | C | 1812 | 3.3 | 1.7 | 4.7 | 100 | DEDC1560(1)A5N00 | LDEDC1560(1)A5N00 |
| 63 | 40 | 0.0056 | A | 1206 | 1.7 | 1.1 | 3.3 | 100 | DEDA1560(1)A0N00 | LDEDA1560(1)A0N00 |
| 63 | 40 | 0.0068 | C | 1812 | 3.3 | 1.7 | 4.7 | 100 | DEDC1680(1)A5N00 | LDEDC1680(1)A5N00 |
| 63 | 40 | 0.0068 | A | 1206 | 1.7 | 1.1 | 3.3 | 100 | DEDA1680(1)A0N00 | LDEDA1680(1)A0N00 |
| 63 | 40 | 0.0082 | C | 1812 | 3.3 | 1.8 | 4.7 | 100 | DEDC1820(1)A5N00 | LDEDC1820(1)A5N00 |
| 63 | 40 | 0.0082 | A | 1206 | 1.7 | 1.1 | 3.3 | 100 | DEDA1820(1)A0N00 | LDEDA1820(1)A0N00 |
| 63 | 40 | 0.01 | C | 1812 | 3.3 | 1.7 | 4.7 | 100 | DEDC2100(1)A5N00 | LDEDC2100(1)A5N00 |
| 63 | 40 | 0.01 | A | 1206 | 1.7 | 1.1 | 3.3 | 100 | DEDA2100(1)A0N00 | LDEDA2100(1)A0N00 |
| 63 | 40 | 0.012 | C | 1812 | 3.3 | 1.7 | 4.7 | 100 | DEDC2120(1)A5N00 | LDEDC2120(1)A5N00 |
| 63 | 40 | 0.012 | A | 1206 | 1.7 | 1.1 | 3.3 | 100 | DEDA2120(1)A0N00 | LDEDA2120(1)A0N00 |
| 63 | 40 | 0.015 | C | 1812 | 3.3 | 1.7 | 4.7 | 100 | DEDC2150(1)A5N00 | LDEDC2150(1)A5N00 |
| 63 | 40 | 0.015 | A | 1206 | 1.7 | 1.2 | 3.3 | 100 | DEDA2150(1)A0N00 | LDEDA2150(1)A0N00 |
| 63 | 40 | 0.018 | C | 1812 | 3.3 | 1.8 | 4.7 | 100 | DEDC2180(1)A5N00 | LDEDC2180(1)A5N00 |
| 63 | 40 | 0.018 | A | 1206 | 1.7 | 1.1 | 3.3 | 100 | DEDA2180(1)A0N00 | LDEDA2180(1)A0N00 |
| 63 | 40 | 0.022 | C | 1812 | 3.3 | 1.7 | 4.7 | 100 | DEDC2220(1)A5N00 | LDEDC2220(1)A5N00 |
| 63 | 40 | 0.022 | A | 1206 | 1.7 | 1.1 | 3.3 | 100 | DEDA2220(1)A0N00 | LDEDA2220(1)A0N00 |
| 63 | 40 | 0.027 | C | 1812 | 3.3 | 1.7 | 4.7 | 100 | DEDC2270(1)A5N00 | LDEDC2270(1)A5N00 |
| 63 | 40 | 0.027 | A | 1206 | 1.7 | 1.1 | 3.3 | 100 | DEDA2270(1)A0N00 | LDEDA2270(1)A0N00 |
| 63 | 40 | 0.033 | C | 1812 | 3.3 | 1.8 | 4.7 | 100 | DEDC2330(1)A5N00 | LDEDC2330(1)A5N00 |
| 63 | 40 | 0.033 | B | 1210 | 2.5 | 2.0 | 3.3 | 100 | DEDB2330(1)A0N00 | LDEDB2330(1)A0N00 |
| 63 | 40 | 0.033 | A | 1206 | 1.7 | 1.2 | 3.3 | 100 | DEDA2330(2)A0N00 | LDEDA2330(2)A0N00 |
| 63 | 40 | 0.039 | C | 1812 | 3.3 | 1.7 | 4.7 | 100 | DEDC2390(1)A5N00 | LDEDC2390(1)A5N00 |
| 63 | 40 | 0.039 | B | 1210 | 2.5 | 2.1 | 3.3 | 100 | DEDB2390(1)A0N00 | LDEDB2390(1)A0N00 |
| 63 | 40 | 0.047 | C | 1812 | 3.3 | 1.7 | 4.7 | 100 | DEDC2470(1)A5N00 | LDEDC2470(1)A5N00 |
| VDC | VAC | Capacitance Value (µF) | Size Code | Chip Size | W (mm) | H (mm) | L (mm) | dV/dt (V/µs) | New KEMET Part Number | Legacy Part Number |

(1) K = ±10%, M = ±20%, J = ±5% on request.

(2) Only K and M tolerances available.

Table 1 – Ratings & Part Number Reference cont.

| VDC | VAC | Capacitance Value (µF) | Size Code | Chip Size | Dimensions in mm | | | dV/dt (V/µs) | New KEMET Part Number | Legacy Part Number |
|-----|-----|------------------------|-----------|-----------|------------------|---------|--------|--------------|-----------------------|--------------------|
| | | | | | W | H (max) | L | | | |
| 63 | 40 | 0.047 | B | 1210 | 2.5 | 2.1 | 3.3 | 100 | DEDB2470(1)A0N00 | LDEDB2470(1)A0N00 |
| 63 | 40 | 0.056 | C | 1812 | 3.3 | 1.7 | 4.7 | 100 | DEDC2560(1)A5N00 | LDEDC2560(1)A5N00 |
| 63 | 40 | 0.056 | B | 1210 | 2.5 | 1.7 | 3.3 | 100 | DEDB2560(1)A0N00 | LDEDB2560(1)A0N00 |
| 63 | 40 | 0.068 | C | 1812 | 3.3 | 1.8 | 4.7 | 100 | DEDC2680(1)A5N00 | LDEDC2680(1)A5N00 |
| 63 | 40 | 0.068 | B | 1210 | 2.5 | 2.0 | 3.3 | 100 | DEDB2680(1)A0N00 | LDEDB2680(1)A0N00 |
| 63 | 40 | 0.082 | C | 1812 | 3.3 | 2.1 | 4.7 | 100 | DEDC2820(1)A5N00 | LDEDC2820(1)A5N00 |
| 63 | 40 | 0.082 | B | 1210 | 2.5 | 2.1 | 3.3 | 100 | DEDB2820(1)A0N00 | LDEDB2820(1)A0N00 |
| 63 | 40 | 0.1 | C | 1812 | 3.3 | 2.4 | 4.7 | 100 | DEDC3100(1)A5N00 | LDEDC3100(1)A5N00 |
| 63 | 40 | 0.1 | B | 1210 | 2.5 | 2.1 | 3.3 | 100 | DEDB3100(1)A0N00 | LDEDB3100(1)A0N00 |
| 63 | 40 | 0.12 | C | 1812 | 3.3 | 1.7 | 4.7 | 100 | DEDC3120(1)A5N00 | LDEDC3120(1)A5N00 |
| 63 | 40 | 0.15 | C | 1812 | 3.3 | 1.9 | 4.7 | 100 | DEDC3150(1)A5N00 | LDEDC3150(1)A5N00 |
| 63 | 40 | 0.18 | C | 1812 | 3.3 | 2.2 | 4.7 | 100 | DEDC3180(1)A5N00 | LDEDC3180(1)A5N00 |
| 63 | 40 | 0.22 | C | 1812 | 3.3 | 2.4 | 4.7 | 100 | DEDC3220(1)A5N00 | LDEDC3220(1)A5N00 |
| 63 | 40 | 0.27 | D | 2220 | 5.0 | 1.9 | 6.0 | 100 | DEDD3270(1)A5N00 | LDEDD3270(1)A5N00 |
| 63 | 40 | 0.33 | D | 2220 | 5.0 | 1.9 | 6.0 | 100 | DEDD3330(1)A5N00 | LDEDD3330(1)A5N00 |
| 63 | 40 | 0.39 | D | 2220 | 5.0 | 2.1 | 6.0 | 100 | DEDD3390(1)A5N00 | LDEDD3390(1)A5N00 |
| 63 | 40 | 0.47 | D | 2220 | 5.0 | 2.4 | 6.0 | 100 | DEDD3470(1)A5N00 | LDEDD3470(1)A5N00 |
| 63 | 40 | 0.56 | D | 2220 | 5.0 | 2.8 | 6.0 | 100 | DEDD3560(1)A5N00 | LDEDD3560(1)A5N00 |
| 63 | 40 | 0.68 | D | 2220 | 5.0 | 3.3 | 6.0 | 100 | DEDD3680(1)A5N00 | LDEDD3680(1)A5N00 |
| 63 | 40 | 0.82 | E | 2824 | 6.1 | 2.9 | 7.3 | 100 | DEDE3820(1)A5N00 | LDEDE3820(1)A5N00 |
| 63 | 40 | 0.82 | D | 2220 | 5.0 | 3.7 | 6.0 | 100 | DEDD3820(1)A0N00 | LDEDD3820(1)A0N00 |
| 63 | 40 | 1.0 | E | 2824 | 6.1 | 3.1 | 7.3 | 100 | DEDE4100(1)A5N00 | LDEDE4100(1)A5N00 |
| 63 | 40 | 1.0 | D | 2220 | 5.0 | 4.4 | 6.0 | 100 | DEDD4100(1)A0N00 | LDEDD4100(1)A0N00 |
| 63 | 40 | 1.2 | E | 2824 | 6.1 | 3.6 | 7.3 | 100 | DEDE4120(1)A5N00 | LDEDE4120(1)A5N00 |
| 63 | 40 | 1.5 | G | 5040 | 10.4 | 3.1 | 13.0 | 100 | DEDG4150(1)A5N00 | LDEDG4150(1)A5N00 |
| 63 | 40 | 1.5 | E | 2824 | 6.1 | 4.3 | 7.3 | 100 | DEDE4150(1)A0N00 | LDEDE4150(1)A0N00 |
| 63 | 40 | 1.8 | G | 5040 | 10.4 | 3.4 | 13.0 | 100 | DEDG4180(1)A5N00 | LDEDG4180(1)A5N00 |
| 63 | 40 | 1.8 | E | 2824 | 6.1 | 5.1 | 7.3 | 100 | DEDE4180(1)A0N00 | LDEDE4180(1)A0N00 |
| 63 | 40 | 2.2 | G | 5040 | 10.4 | 4.1 | 13.0 | 100 | DEDG4220(1)A5N00 | LDEDG4220(1)A5N00 |
| 63 | 40 | 2.2 | F | 4030 | 7.9 | 3.3 | 10.5 | 100 | DEDF4220(1)A0N00 | LDEDF4220(1)A0N00 |
| 63 | 40 | 2.7 | G | 5040 | 10.4 | 4.9 | 13.0 | 100 | DEDG4270(1)A5N00 | LDEDG4270(1)A5N00 |
| 63 | 40 | 2.7 | F | 4030 | 7.9 | 4.0 | 10.5 | 100 | DEDF4270(1)A0N00 | LDEDF4270(1)A0N00 |
| 63 | 40 | 3.3 | H | 6054 | 13.7 | 3.9 | 15.5 | 100 | DEDH4330(1)A5N00 | LDEDH4330(1)A5N00 |
| 63 | 40 | 3.3 | F | 4030 | 7.9 | 4.7 | 10.5 | 100 | DEDF4330(1)A0N00 | LDEDF4330(1)A0N00 |
| 63 | 40 | 3.9 | H | 6054 | 13.7 | 4.5 | 15.5 | 100 | DEDH4390(1)A5N00 | LDEDH4390(1)A5N00 |
| 63 | 40 | 3.9 | F | 4030 | 7.9 | 5.5 | 10.5 | 100 | DEDF4390(1)A0N00 | LDEDF4390(1)A0N00 |
| 63 | 40 | 4.7 | H | 6054 | 13.7 | 5.3 | 15.5 | 100 | DEDH4470(1)A5N00 | LDEDH4470(1)A5N00 |
| 63 | 40 | 4.7 | G | 5040 | 10.4 | 4.1 | 13.0 | 100 | DEDG4470(1)A0N00 | LDEDG4470(1)A0N00 |
| 100 | 63 | 0.001 | A | 1206 | 1.7 | 1.1 | 3.3 | 100 | DEEA1100(1)A0N00 | LDEEA1100(1)A0N00 |
| 100 | 63 | 0.0012 | A | 1206 | 1.7 | 1.1 | 3.3 | 100 | DEEA1120(1)A0N00 | LDEEA1120(1)A0N00 |
| 100 | 63 | 0.0015 | C | 1812 | 3.3 | 1.7 | 4.7 | 100 | DEEC1150(1)A5N00 | LDEEC1150(1)A5N00 |
| 100 | 63 | 0.0015 | A | 1206 | 1.7 | 1.1 | 3.3 | 100 | DEEA1150(1)A0N00 | LDEEA1150(1)A0N00 |
| 100 | 63 | 0.0018 | C | 1812 | 3.3 | 1.7 | 4.7 | 100 | DEEC1180(1)A5N00 | LDEEC1180(1)A5N00 |
| 100 | 63 | 0.0018 | A | 1206 | 1.7 | 1.1 | 3.3 | 100 | DEEA1180(1)A0N00 | LDEEA1180(1)A0N00 |
| 100 | 63 | 0.0022 | C | 1812 | 3.3 | 1.7 | 4.7 | 100 | DEEC1220(1)A5N00 | LDEEC1220(1)A5N00 |
| 100 | 63 | 0.0022 | A | 1206 | 1.7 | 1.1 | 3.3 | 100 | DEEA1220(1)A0N00 | LDEEA1220(1)A0N00 |
| 100 | 63 | 0.0027 | C | 1812 | 3.3 | 1.8 | 4.7 | 100 | DEEC1270(1)A5N00 | LDEEC1270(1)A5N00 |
| 100 | 63 | 0.0027 | A | 1206 | 1.7 | 1.1 | 3.3 | 100 | DEEA1270(1)A0N00 | LDEEA1270(1)A0N00 |
| 100 | 63 | 0.0033 | C | 1812 | 3.3 | 1.7 | 4.7 | 100 | DEEC1330(1)A5N00 | LDEEC1330(1)A5N00 |
| 100 | 63 | 0.0033 | A | 1206 | 1.7 | 1.2 | 3.3 | 100 | DEEA1330(1)A0N00 | LDEEA1330(1)A0N00 |
| 100 | 63 | 0.0039 | C | 1812 | 3.3 | 1.7 | 4.7 | 100 | DEEC1390(1)A5N00 | LDEEC1390(1)A5N00 |
| 100 | 63 | 0.0039 | A | 1206 | 1.7 | 1.1 | 3.3 | 100 | DEEA1390(1)A0N00 | LDEEA1390(1)A0N00 |
| 100 | 63 | 0.0047 | C | 1812 | 3.3 | 1.8 | 4.7 | 100 | DEEC1470(1)A5N00 | LDEEC1470(1)A5N00 |
| 100 | 63 | 0.0047 | A | 1206 | 1.7 | 1.1 | 3.3 | 100 | DEEA1470(1)A0N00 | LDEEA1470(1)A0N00 |
| 100 | 63 | 0.0056 | C | 1812 | 3.3 | 1.7 | 4.7 | 100 | DEEC1560(1)A5N00 | LDEEC1560(1)A5N00 |
| 100 | 63 | 0.0056 | A | 1206 | 1.7 | 1.1 | 3.3 | 100 | DEEA1560(1)A0N00 | LDEEA1560(1)A0N00 |
| 100 | 63 | 0.0068 | C | 1812 | 3.3 | 1.7 | 4.7 | 100 | DEEC1680(1)A5N00 | LDEEC1680(1)A5N00 |
| 100 | 63 | 0.0068 | A | 1206 | 1.7 | 1.1 | 3.3 | 100 | DEEA1680(1)A0N00 | LDEEA1680(1)A0N00 |
| 100 | 63 | 0.0082 | C | 1812 | 3.3 | 1.8 | 4.7 | 100 | DEEC1820(1)A5N00 | LDEEC1820(1)A5N00 |
| VDC | VAC | Capacitance Value (µF) | Size Code | Chip Size | W (mm) | H (mm) | L (mm) | dV/dt (V/µs) | New KEMET Part Number | Legacy Part Number |

(1) K = ±10%, M = ±20%, J = ±5% on request.

(2) Only K and M tolerances available.

Table 1 – Ratings & Part Number Reference cont.

| VDC | VAC | Capacitance Value (µF) | Size Code | Chip Size | Dimensions in mm | | | dV/dt (V/µs) | New KEMET Part Number | Legacy Part Number |
|-----|-----|------------------------|-----------|-----------|------------------|---------|--------|--------------|-----------------------|--------------------|
| | | | | | W | H (max) | L | | | |
| 100 | 63 | 0.0082 | A | 1206 | 1.7 | 1.1 | 3.3 | 100 | DEEA1820(1)A0N00 | LDEEA1820(1)A0N00 |
| 100 | 63 | 0.01 | C | 1812 | 3.3 | 1.7 | 4.7 | 100 | DEEC2100(1)A5N00 | LDEEC2100(1)A5N00 |
| 100 | 63 | 0.01 | A | 1206 | 1.7 | 1.1 | 3.3 | 100 | DEEA2100(1)A0N00 | LDEEA2100(1)A0N00 |
| 100 | 63 | 0.012 | C | 1812 | 3.3 | 1.7 | 4.7 | 100 | DEEC2120(1)A5N00 | LDEEC2120(1)A5N00 |
| 100 | 63 | 0.012 | A | 1206 | 1.7 | 1.1 | 3.3 | 100 | DEEA2120(1)A0N00 | LDEEA2120(1)A0N00 |
| 100 | 63 | 0.015 | C | 1812 | 3.3 | 1.7 | 4.7 | 100 | DEEC2150(1)A5N00 | LDEEC2150(1)A5N00 |
| 100 | 63 | 0.015 | A | 1206 | 1.7 | 1.2 | 3.3 | 100 | DEEA2150(1)A0N00 | LDEEA2150(1)A0N00 |
| 100 | 63 | 0.018 | C | 1812 | 3.3 | 1.8 | 4.7 | 100 | DEEC2180(1)A5N00 | LDEEC2180(1)A5N00 |
| 100 | 63 | 0.018 | B | 1210 | 2.5 | 1.5 | 3.3 | 100 | DEEB2180(1)A0N00 | LDEEB2180(1)A0N00 |
| 100 | 63 | 0.022 | C | 1812 | 3.3 | 1.7 | 4.7 | 100 | DEEC2220(1)A5N00 | LDEEC2220(1)A5N00 |
| 100 | 63 | 0.022 | B | 1210 | 2.5 | 1.5 | 3.3 | 100 | DEEB2220(1)A0N00 | LDEEB2220(1)A0N00 |
| 100 | 63 | 0.027 | C | 1812 | 3.3 | 1.7 | 4.7 | 100 | DEEC2270(1)A5N00 | LDEEC2270(1)A5N00 |
| 100 | 63 | 0.027 | B | 1210 | 2.5 | 1.7 | 3.3 | 100 | DEEB2270(1)A0N00 | LDEEB2270(1)A0N00 |
| 100 | 63 | 0.033 | C | 1812 | 3.3 | 1.8 | 4.7 | 100 | DEEC2330(1)A5N00 | LDEEC2330(1)A5N00 |
| 100 | 63 | 0.033 | B | 1210 | 2.5 | 2.0 | 3.3 | 100 | DEEB2330(1)A0N00 | LDEEB2330(1)A0N00 |
| 100 | 63 | 0.039 | C | 1812 | 3.3 | 1.7 | 4.7 | 100 | DEEC2390(1)A5N00 | LDEEC2390(1)A5N00 |
| 100 | 63 | 0.039 | B | 1210 | 2.5 | 2.1 | 3.3 | 100 | DEEB2390(1)A0N00 | LDEEB2390(1)A0N00 |
| 100 | 63 | 0.047 | C | 1812 | 3.3 | 1.7 | 4.7 | 100 | DEEC2470(1)A5N00 | LDEEC2470(1)A5N00 |
| 100 | 63 | 0.047 | B | 1210 | 2.5 | 2.1 | 3.3 | 100 | DEEB2470(1)A0N00 | LDEEB2470(1)A0N00 |
| 100 | 63 | 0.056 | C | 1812 | 3.3 | 1.7 | 4.7 | 100 | DEEC2560(1)A5N00 | LDEEC2560(1)A5N00 |
| 100 | 63 | 0.068 | C | 1812 | 3.3 | 1.8 | 4.7 | 100 | DEEC2680(1)A5N00 | LDEEC2680(1)A5N00 |
| 100 | 63 | 0.082 | C | 1812 | 3.3 | 2.1 | 4.7 | 100 | DEEC2820(1)A5N00 | LDEEC2820(1)A5N00 |
| 100 | 63 | 0.1 | C | 1812 | 3.3 | 2.4 | 4.7 | 100 | DEEC3100(1)A5N00 | LDEEC3100(1)A5N00 |
| 100 | 63 | 0.12 | D | 2220 | 5.0 | 1.9 | 6.0 | 100 | DEED3120(1)A5N00 | LDEED3120(1)A5N00 |
| 100 | 63 | 0.15 | D | 2220 | 5.0 | 1.9 | 6.0 | 100 | DEED3150(1)A5N00 | LDEED3150(1)A5N00 |
| 100 | 63 | 0.18 | D | 2220 | 5.0 | 2.0 | 6.0 | 100 | DEED3180(1)A5N00 | LDEED3180(1)A5N00 |
| 100 | 63 | 0.22 | D | 2220 | 5.0 | 2.4 | 6.0 | 100 | DEED3220(1)A5N00 | LDEED3220(1)A5N00 |
| 100 | 63 | 0.27 | D | 2220 | 5.0 | 2.8 | 6.0 | 100 | DEED3270(1)A5N00 | LDEED3270(1)A5N00 |
| 100 | 63 | 0.33 | D | 2220 | 5.0 | 3.3 | 6.0 | 100 | DEED3330(1)A5N00 | LDEED3330(1)A5N00 |
| 100 | 63 | 0.39 | E | 2824 | 6.1 | 2.6 | 7.3 | 100 | DEEE3390(1)A5N00 | LDEEE3390(1)A5N00 |
| 100 | 63 | 0.39 | D | 2220 | 5.0 | 3.7 | 6.0 | 100 | DEED3390(1)A0N00 | LDEED3390(1)A0N00 |
| 100 | 63 | 0.47 | E | 2824 | 6.1 | 3.0 | 7.3 | 100 | DEEE3470(1)A5N00 | LDEEE3470(1)A5N00 |
| 100 | 63 | 0.47 | D | 2220 | 5.0 | 4.4 | 6.0 | 100 | DEED3470(1)A0N00 | LDEED3470(1)A0N00 |
| 100 | 63 | 0.56 | E | 2824 | 6.1 | 3.5 | 7.3 | 100 | DEEE3560(1)A5N00 | LDEEE3560(1)A5N00 |
| 100 | 63 | 0.68 | E | 2824 | 6.1 | 4.1 | 7.3 | 100 | DEEE3680(1)A5N00 | LDEEE3680(1)A5N00 |
| 100 | 63 | 0.82 | F | 4030 | 7.9 | 2.8 | 10.5 | 100 | DEEF3820(1)A5N00 | LDEEF3820(1)A5N00 |
| 100 | 63 | 0.82 | E | 2824 | 6.1 | 4.9 | 7.3 | 100 | DEEE3820(1)A0N00 | LDEEE3820(1)A0N00 |
| 100 | 63 | 1.0 | F | 4030 | 7.9 | 3.2 | 10.5 | 100 | DEEF4100(1)A5N00 | LDEEF4100(1)A5N00 |
| 100 | 63 | 1.0 | E | 2824 | 6.1 | 5.4 | 7.3 | 100 | DEEE4100(2)A0N00 | LDEEE4100(2)A0N00 |
| 100 | 63 | 1.2 | G | 5040 | 10.4 | 3.1 | 13.0 | 100 | DEEG4120(1)A5N00 | LDEEG4120(1)A5N00 |
| 100 | 63 | 1.2 | F | 4030 | 7.9 | 3.7 | 10.5 | 100 | DEEF4120(1)A0N00 | LDEEF4120(1)A0N00 |
| 100 | 63 | 1.5 | G | 5040 | 10.4 | 3.1 | 13.0 | 100 | DEEG4150(1)A5N00 | LDEEG4150(1)A5N00 |
| 100 | 63 | 1.5 | F | 4030 | 7.9 | 4.5 | 10.5 | 100 | DEEF4150(1)A0N00 | LDEEF4150(1)A0N00 |
| 100 | 63 | 1.8 | G | 5040 | 10.4 | 3.4 | 13.0 | 100 | DEEG4180(1)A5N00 | LDEEG4180(1)A5N00 |
| 100 | 63 | 1.8 | F | 4030 | 7.9 | 5.4 | 10.5 | 100 | DEEF4180(1)A0N00 | LDEEF4180(1)A0N00 |
| 100 | 63 | 2.2 | G | 5040 | 10.4 | 4.1 | 13.0 | 100 | DEEG4220(1)A5N00 | LDEEG4220(1)A5N00 |
| 100 | 63 | 2.2 | F | 4030 | 7.9 | 5.6 | 10.5 | 100 | DEEF4220(2)A0N00 | LDEEF4220(2)A0N00 |
| 100 | 63 | 2.7 | H | 6054 | 13.7 | 3.3 | 15.5 | 100 | DEEH4270(1)A5N00 | LDEEH4270(1)A5N00 |
| 100 | 63 | 2.7 | G | 5040 | 10.4 | 4.9 | 13.0 | 100 | DEEG4270(1)A0N00 | LDEEG4270(1)A0N00 |
| 100 | 63 | 3.3 | H | 6054 | 13.7 | 3.9 | 15.5 | 100 | DEEH4330(1)A5N00 | LDEEH4330(1)A5N00 |
| 100 | 63 | 3.3 | G | 5040 | 10.4 | 5.7 | 13.0 | 100 | DEEG4330(1)A0N00 | LDEEG4330(1)A0N00 |
| 100 | 63 | 3.9 | H | 6054 | 13.7 | 4.5 | 15.5 | 100 | DEEH4390(1)A5N00 | LDEEH4390(1)A5N00 |
| 100 | 63 | 4.7 | H | 6054 | 13.7 | 5.3 | 15.5 | 100 | DEEH4470(1)A5N00 | LDEEH4470(1)A5N00 |
| 250 | 120 | 0.001 | A | 1206 | 1.7 | 1.1 | 3.3 | 100 | DEIA1100(1)A0N00 | LDEIA1100(1)A0N00 |
| 250 | 120 | 0.0012 | A | 1206 | 1.7 | 1.1 | 3.3 | 100 | DEIA1120(1)A0N00 | LDEIA1120(1)A0N00 |
| 250 | 120 | 0.0015 | C | 1812 | 3.3 | 1.7 | 4.7 | 100 | DEIC1150(1)A5N00 | LDEIC1150(1)A5N00 |
| 250 | 120 | 0.0015 | A | 1206 | 1.7 | 1.1 | 3.3 | 100 | DEIA1150(1)A0N00 | LDEIA1150(1)A0N00 |
| 250 | 120 | 0.0018 | C | 1812 | 3.3 | 1.7 | 4.7 | 100 | DEIC1180(1)A5N00 | LDEIC1180(1)A5N00 |
| 250 | 120 | 0.0018 | A | 1206 | 1.7 | 1.1 | 3.3 | 100 | DEIA1180(1)A0N00 | LDEIA1180(1)A0N00 |
| VDC | VAC | Capacitance Value (µF) | Size Code | Chip Size | W (mm) | H (mm) | L (mm) | dV/dt (V/µs) | New KEMET Part Number | Legacy Part Number |

(1) K = ±10%, M = ±20%, J = ±5% on request.

(2) Only K and M tolerances available.

Table 1 – Ratings & Part Number Reference cont.

| VDC | VAC | Capacitance Value (µF) | Size Code | Chip Size | Dimensions in mm | | | dV/dt (V/µs) | New KEMET Part Number | Legacy Part Number |
|-----|-----|------------------------|-----------|-----------|------------------|---------|--------|--------------|-----------------------|--------------------|
| | | | | | W | H (max) | L | | | |
| 250 | 120 | 0.0022 | C | 1812 | 3.3 | 1.7 | 4.7 | 100 | DEIC1220(1)A5N00 | LDEIC1220(1)A5N00 |
| 250 | 120 | 0.0022 | A | 1206 | 1.7 | 1.1 | 3.3 | 100 | DEIA1220(1)A0N00 | LDEIA1220(1)A0N00 |
| 250 | 120 | 0.0027 | C | 1812 | 3.3 | 1.8 | 4.7 | 100 | DEIC1270(1)A5N00 | LDEIC1270(1)A5N00 |
| 250 | 120 | 0.0027 | A | 1206 | 1.7 | 1.1 | 3.3 | 100 | DEIA1270(1)A0N00 | LDEIA1270(1)A0N00 |
| 250 | 120 | 0.0033 | C | 1812 | 3.3 | 1.7 | 4.7 | 100 | DEIC1330(1)A5N00 | LDEIC1330(1)A5N00 |
| 250 | 120 | 0.0033 | A | 1206 | 1.7 | 1.2 | 3.3 | 100 | DEIA1330(1)A0N00 | LDEIA1330(1)A0N00 |
| 250 | 120 | 0.0039 | C | 1812 | 3.3 | 1.7 | 4.7 | 100 | DEIC1390(1)A5N00 | LDEIC1390(1)A5N00 |
| 250 | 120 | 0.0039 | B | 1210 | 2.5 | 1.6 | 3.3 | 100 | DEIB1390(1)A0N00 | LDEIB1390(1)A0N00 |
| 250 | 120 | 0.0047 | C | 1812 | 3.3 | 1.8 | 4.7 | 100 | DEIC1470(1)A5N00 | LDEIC1470(1)A5N00 |
| 250 | 120 | 0.0047 | B | 1210 | 2.5 | 1.6 | 3.3 | 100 | DEIB1470(1)A0N00 | LDEIB1470(1)A0N00 |
| 250 | 120 | 0.0056 | C | 1812 | 3.3 | 1.7 | 4.7 | 100 | DEIC1560(1)A5N00 | LDEIC1560(1)A5N00 |
| 250 | 120 | 0.0056 | B | 1210 | 2.5 | 1.6 | 3.3 | 100 | DEIB1560(1)A0N00 | LDEIB1560(1)A0N00 |
| 250 | 120 | 0.0068 | C | 1812 | 3.3 | 1.7 | 4.7 | 100 | DEIC1680(1)A5N00 | LDEIC1680(1)A5N00 |
| 250 | 120 | 0.0068 | B | 1210 | 2.5 | 1.8 | 3.3 | 100 | DEIB1680(1)A0N00 | LDEIB1680(1)A0N00 |
| 250 | 120 | 0.0082 | C | 1812 | 3.3 | 1.8 | 4.7 | 100 | DEIC1820(1)A5N00 | LDEIC1820(1)A5N00 |
| 250 | 120 | 0.0082 | B | 1210 | 2.5 | 2.0 | 3.3 | 100 | DEIB1820(1)A0N00 | LDEIB1820(1)A0N00 |
| 250 | 120 | 0.01 | C | 1812 | 3.3 | 1.7 | 4.7 | 100 | DEIC2100(1)A5N00 | LDEIC2100(1)A5N00 |
| 250 | 120 | 0.01 | B | 1210 | 2.5 | 2.1 | 3.3 | 100 | DEIB2100(1)A0N00 | LDEIB2100(1)A0N00 |
| 250 | 120 | 0.012 | C | 1812 | 3.3 | 1.7 | 4.7 | 100 | DEIC2120(1)A5N00 | LDEIC2120(1)A5N00 |
| 250 | 120 | 0.015 | C | 1812 | 3.3 | 1.7 | 4.7 | 100 | DEIC2150(1)A5N00 | LDEIC2150(1)A5N00 |
| 250 | 120 | 0.018 | D | 2220 | 5.0 | 2.2 | 6.0 | 100 | DEID2180(1)A5N00 | LDEID2180(1)A5N00 |
| 250 | 120 | 0.018 | C | 1812 | 3.3 | 1.8 | 4.7 | 100 | DEIC2180(1)A0N00 | LDEIC2180(1)A0N00 |
| 250 | 120 | 0.022 | D | 2220 | 5.0 | 2.5 | 6.0 | 100 | DEID2220(1)A5N00 | LDEID2220(1)A5N00 |
| 250 | 120 | 0.022 | C | 1812 | 3.3 | 2.2 | 4.7 | 100 | DEIC2220(1)A0N00 | LDEIC2220(1)A0N00 |
| 250 | 120 | 0.027 | D | 2220 | 5.0 | 2.9 | 6.0 | 100 | DEID2270(1)A5N00 | LDEID2270(1)A5N00 |
| 250 | 120 | 0.027 | C | 1812 | 3.3 | 2.5 | 4.7 | 100 | DEIC2270(1)A0N00 | LDEIC2270(1)A0N00 |
| 250 | 120 | 0.033 | D | 2220 | 5.0 | 1.9 | 6.0 | 100 | DEID2330(1)A5N00 | LDEID2330(1)A5N00 |
| 250 | 120 | 0.033 | C | 1812 | 3.3 | 2.6 | 4.7 | 100 | DEIC2330(1)A0N00 | LDEIC2330(1)A0N00 |
| 250 | 120 | 0.039 | D | 2220 | 5.0 | 2.1 | 6.0 | 100 | DEID2390(1)A5N00 | LDEID2390(1)A5N00 |
| 250 | 120 | 0.047 | D | 2220 | 5.0 | 2.3 | 6.0 | 100 | DEID2470(1)A5N00 | LDEID2470(1)A5N00 |
| 250 | 120 | 0.056 | D | 2220 | 5.0 | 2.6 | 6.0 | 100 | DEID2560(1)A5N00 | LDEID2560(1)A5N00 |
| 250 | 120 | 0.068 | D | 2220 | 5.0 | 2.8 | 6.0 | 100 | DEID2680(1)A5N00 | LDEID2680(1)A5N00 |
| 250 | 120 | 0.082 | E | 2824 | 6.1 | 2.6 | 7.3 | 100 | DEIE2820(1)A5N00 | LDEIE2820(1)A5N00 |
| 250 | 120 | 0.082 | D | 2220 | 5.0 | 3.5 | 6.0 | 100 | DEID2820(1)A0N00 | LDEID2820(1)A0N00 |
| 250 | 120 | 0.1 | E | 2824 | 6.1 | 2.9 | 7.3 | 100 | DEIE3100(1)A5N00 | LDEIE3100(1)A5N00 |
| 250 | 120 | 0.1 | D | 2220 | 5.0 | 4.1 | 6.0 | 100 | DEID3100(1)A0N00 | LDEID3100(1)A0N00 |
| 250 | 120 | 0.12 | E | 2824 | 6.1 | 3.3 | 7.3 | 100 | DEIE3120(1)A5N00 | LDEIE3120(1)A5N00 |
| 250 | 120 | 0.12 | D | 2220 | 5.0 | 4.4 | 6.0 | 100 | DEID3120(1)A0N00 | LDEID3120(1)A0N00 |
| 250 | 120 | 0.15 | E | 2824 | 6.1 | 3.8 | 7.3 | 100 | DEIE3150(1)A5N00 | LDEIE3150(1)A5N00 |
| 250 | 120 | 0.18 | F | 4030 | 7.9 | 2.7 | 10.5 | 100 | DEIF3180(1)A5N00 | LDEIF3180(1)A5N00 |
| 250 | 120 | 0.18 | E | 2824 | 6.1 | 4.4 | 7.3 | 100 | DEIE3180(1)A0N00 | LDEIE3180(1)A0N00 |
| 250 | 120 | 0.22 | F | 4030 | 7.9 | 3.1 | 10.5 | 100 | DEIF3220(1)A5N00 | LDEIF3220(1)A5N00 |
| 250 | 120 | 0.22 | E | 2824 | 6.1 | 5.2 | 7.3 | 100 | DEIE3220(1)A0N00 | LDEIE3220(1)A0N00 |
| 250 | 120 | 0.27 | F | 4030 | 7.9 | 3.7 | 10.5 | 100 | DEIF3270(1)A5N00 | LDEIF3270(1)A5N00 |
| 250 | 120 | 0.33 | F | 4030 | 7.9 | 4.3 | 10.5 | 100 | DEIF3330(1)A5N00 | LDEIF3330(1)A5N00 |
| 250 | 120 | 0.39 | G | 5040 | 10.4 | 3.3 | 13.0 | 100 | DEIG3390(1)A5N00 | LDEIG3390(1)A5N00 |
| 250 | 120 | 0.39 | F | 4030 | 7.9 | 5.0 | 10.5 | 100 | DEIF3390(1)A0N00 | LDEIF3390(1)A0N00 |
| 250 | 120 | 0.47 | G | 5040 | 10.4 | 3.8 | 13.0 | 100 | DEIG3470(1)A5N00 | LDEIG3470(1)A5N00 |
| 250 | 120 | 0.47 | F | 4030 | 7.9 | 5.5 | 10.5 | 100 | DEIF3470(1)A0N00 | LDEIF3470(1)A0N00 |
| 250 | 120 | 0.56 | G | 5040 | 10.4 | 4.4 | 13.0 | 100 | DEIG3560(1)A5N00 | LDEIG3560(1)A5N00 |
| 250 | 120 | 0.56 | F | 4030 | 7.9 | 5.5 | 10.5 | 100 | DEIF3560(1)A0N00 | LDEIF3560(1)A0N00 |
| 250 | 120 | 0.68 | H | 6054 | 13.7 | 3.4 | 15.5 | 100 | DEIH3680(1)A5N00 | LDEIH3680(1)A5N00 |
| 250 | 120 | 0.68 | G | 5040 | 10.4 | 5.2 | 13.0 | 100 | DEIG3680(1)A0N00 | LDEIG3680(1)A0N00 |
| 250 | 120 | 0.82 | H | 6054 | 13.7 | 3.9 | 15.5 | 100 | DEIH3820(1)A5N00 | LDEIH3820(1)A5N00 |
| 250 | 120 | 0.82 | G | 5040 | 10.4 | 5.7 | 13.0 | 100 | DEIG3820(1)A0N00 | LDEIG3820(1)A0N00 |
| 250 | 120 | 1.0 | H | 6054 | 13.7 | 4.6 | 15.5 | 100 | DEIH4100(1)A5N00 | LDEIH4100(1)A5N00 |
| 250 | 120 | 1.2 | H | 6054 | 13.7 | 5.4 | 15.5 | 100 | DEIH4120(1)A0N00 | LDEIH4120(1)A0N00 |
| 250 | 120 | 1.5 | H | 6054 | 13.7 | 5.7 | 15.5 | 100 | DEIH4150(1)A0N00 | LDEIH4150(1)A0N00 |
| 400 | 160 | 0.015 | D | 2220 | 5.0 | 2.1 | 6.0 | 100 | DEMD2150(1)A5N00 | LDEMD2150(1)A5N00 |
| VDC | VAC | Capacitance Value (µF) | Size Code | Chip Size | W (mm) | H (mm) | L (mm) | dV/dt (V/µs) | New KEMET Part Number | Legacy Part Number |

(1) K = ±10%, M = ±20%, J = ±5% on request.

(2) Only K and M tolerances available.

Table 1 – Ratings & Part Number Reference cont.

| VDC | VAC | Capacitance Value (µF) | Size Code | Chip Size | Dimensions in mm | | | dV/dt (V/µs) | New KEMET Part Number | Legacy Part Number |
|------|-----|------------------------|-----------|-----------|------------------|---------|--------|--------------|-----------------------|--------------------|
| | | | | | W | H (max) | L | | | |
| 400 | 160 | 0.018 | D | 2220 | 5.0 | 2.2 | 6.0 | 100 | DEMD2180(1)A5N00 | LDEMD2180(1)A5N00 |
| 400 | 160 | 0.022 | D | 2220 | 5.0 | 2.5 | 6.0 | 100 | DEMD2220(1)A5N00 | LDEMD2220(1)A5N00 |
| 400 | 160 | 0.027 | D | 2220 | 5.0 | 2.9 | 6.0 | 100 | DEMD2270(1)A5N00 | LDEMD2270(1)A5N00 |
| 400 | 160 | 0.033 | D | 2220 | 5.0 | 3.4 | 6.0 | 100 | DEMD2330(1)A5N00 | LDEMD2330(1)A5N00 |
| 400 | 160 | 0.039 | D | 2220 | 5.0 | 3.8 | 6.0 | 100 | DEMD2390(1)A5N00 | LDEMD2390(1)A5N00 |
| 400 | 160 | 0.047 | D | 2220 | 5.0 | 4.4 | 6.0 | 100 | DEMD2470(1)A5N00 | LDEMD2470(1)A5N00 |
| 400 | 160 | 0.056 | E | 2824 | 6.1 | 3.5 | 7.3 | 100 | DEME2560(1)A5N00 | LDEME2560(1)A5N00 |
| 400 | 160 | 0.068 | E | 2824 | 6.1 | 4.1 | 7.3 | 100 | DEME2680(1)A5N00 | LDEME2680(1)A5N00 |
| 400 | 160 | 0.082 | E | 2824 | 6.1 | 4.7 | 7.3 | 100 | DEME2820(1)A5N00 | LDEME2820(1)A5N00 |
| 400 | 160 | 0.1 | E | 2824 | 6.1 | 5.4 | 7.3 | 100 | DEME3100(1)A5N00 | LDEME3100(1)A5N00 |
| 400 | 160 | 0.12 | F | 4030 | 7.9 | 3.6 | 10.5 | 100 | DEMF3120(1)A5N00 | LDEMF3120(1)A5N00 |
| 400 | 160 | 0.15 | F | 4030 | 7.9 | 4.4 | 10.5 | 100 | DEMF3150(1)A5N00 | LDEMF3150(1)A5N00 |
| 400 | 160 | 0.18 | F | 4030 | 7.9 | 5.1 | 10.5 | 100 | DEMF3180(1)A5N00 | LDEMF3180(1)A5N00 |
| 400 | 160 | 0.22 | G | 5040 | 10.4 | 3.8 | 13.0 | 100 | DEMG3220(1)A5N00 | LDEMG3220(1)A5N00 |
| 400 | 160 | 0.27 | G | 5040 | 10.4 | 4.7 | 13.0 | 100 | DEMG3270(1)A5N00 | LDEMG3270(1)A5N00 |
| 400 | 160 | 0.33 | G | 5040 | 10.4 | 5.6 | 13.0 | 100 | DEMG3330(1)A5N00 | LDEMG3330(1)A5N00 |
| 400 | 160 | 0.39 | H | 6054 | 13.7 | 4.2 | 15.5 | 100 | DEMH3390(1)A5N00 | LDEMH3390(1)A5N00 |
| 400 | 160 | 0.47 | H | 6054 | 13.7 | 5.3 | 15.5 | 100 | DEMH3470(1)A5N00 | LDEMH3470(1)A5N00 |
| 630 | 200 | 0.001 | D | 2220 | 5.0 | 1.9 | 6.0 | 100 | DEPD1100(1)A5N00 | LDEPD1100(1)A5N00 |
| 630 | 200 | 0.0012 | D | 2220 | 5.0 | 2.0 | 6.0 | 100 | DEPD1120(1)A5N00 | LDEPD1120(1)A5N00 |
| 630 | 200 | 0.0015 | D | 2220 | 5.0 | 2.3 | 6.0 | 100 | DEPD1150(1)A5N00 | LDEPD1150(1)A5N00 |
| 630 | 200 | 0.0018 | D | 2220 | 5.0 | 2.5 | 6.0 | 100 | DEPD1180(1)A5N00 | LDEPD1180(1)A5N00 |
| 630 | 200 | 0.0022 | D | 2220 | 5.0 | 2.0 | 6.0 | 100 | DEPD1220(1)A5N00 | LDEPD1220(1)A5N00 |
| 630 | 200 | 0.0027 | D | 2220 | 5.0 | 2.3 | 6.0 | 100 | DEPD1270(1)A5N00 | LDEPD1270(1)A5N00 |
| 630 | 200 | 0.0033 | D | 2220 | 5.0 | 2.6 | 6.0 | 100 | DEPD1330(1)A5N00 | LDEPD1330(1)A5N00 |
| 630 | 200 | 0.0039 | D | 2220 | 5.0 | 1.9 | 6.0 | 100 | DEPD1390(1)A5N00 | LDEPD1390(1)A5N00 |
| 630 | 200 | 0.0047 | D | 2220 | 5.0 | 2.0 | 6.0 | 100 | DEPD1470(1)A5N00 | LDEPD1470(1)A5N00 |
| 630 | 200 | 0.0056 | D | 2220 | 5.0 | 2.0 | 6.0 | 100 | DEPD1560(1)A5N00 | LDEPD1560(1)A5N00 |
| 630 | 200 | 0.0068 | D | 2220 | 5.0 | 2.3 | 6.0 | 100 | DEPD1680(1)A5N00 | LDEPD1680(1)A5N00 |
| 630 | 200 | 0.0082 | D | 2220 | 5.0 | 2.6 | 6.0 | 100 | DEPD1820(1)A5N00 | LDEPD1820(1)A5N00 |
| 630 | 200 | 0.010 | D | 2220 | 5.0 | 3.0 | 6.0 | 100 | DEPD2100(1)A5N00 | LDEPD2100(1)A5N00 |
| 630 | 200 | 0.012 | D | 2220 | 5.0 | 3.4 | 6.0 | 100 | DEPD2120(1)A5N00 | LDEPD2120(1)A5N00 |
| 630 | 200 | 0.015 | D | 2220 | 5.0 | 4.0 | 6.0 | 100 | DEPD2150(1)A5N00 | LDEPD2150(1)A5N00 |
| 630 | 200 | 0.018 | D | 2220 | 5.0 | 4.4 | 6.0 | 100 | DEPD2180(1)A5N00 | LDEPD2180(1)A5N00 |
| 630 | 200 | 0.022 | E | 2824 | 6.1 | 3.4 | 7.3 | 100 | DEPE2220(1)A5N00 | LDEPE2220(1)A5N00 |
| 630 | 200 | 0.027 | E | 2824 | 6.1 | 4.0 | 7.3 | 100 | DEPE2270(1)A5N00 | LDEPE2270(1)A5N00 |
| 630 | 200 | 0.033 | E | 2824 | 6.1 | 4.7 | 7.3 | 100 | DEPE2330(1)A5N00 | LDEPE2330(1)A5N00 |
| 630 | 200 | 0.039 | E | 2824 | 6.1 | 5.3 | 7.3 | 100 | DEPE2390(1)A5N00 | LDEPE2390(1)A5N00 |
| 630 | 200 | 0.047 | F | 4030 | 7.9 | 3.4 | 10.5 | 100 | DEPF2470(1)A5N00 | LDEPF2470(1)A5N00 |
| 630 | 200 | 0.056 | F | 4030 | 7.9 | 3.9 | 10.5 | 100 | DEPF2560(1)A5N00 | LDEPF2560(1)A5N00 |
| 630 | 200 | 0.068 | F | 4030 | 7.9 | 4.5 | 10.5 | 100 | DEPF2680(1)A5N00 | LDEPF2680(1)A5N00 |
| 630 | 200 | 0.082 | F | 4030 | 7.9 | 5.4 | 10.5 | 100 | DEPF2820(1)A5N00 | LDEPF2820(1)A5N00 |
| 630 | 200 | 0.1 | G | 5040 | 10.4 | 3.9 | 13.0 | 100 | DEPG3100(1)A5N00 | LDEPG3100(1)A5N00 |
| 630 | 200 | 0.1 | F | 4030 | 7.9 | 5.5 | 10.5 | 100 | DEPF3100(2)A0N00 | LDEPF3100(2)A0N00 |
| 630 | 200 | 0.12 | G | 5040 | 10.4 | 4.4 | 13.0 | 100 | DEPG3120(1)A5N00 | LDEPG3120(1)A5N00 |
| 630 | 200 | 0.15 | G | 5040 | 10.4 | 5.3 | 13.0 | 100 | DEPG3150(1)A5N00 | LDEPG3150(1)A5N00 |
| 630 | 200 | 0.18 | H | 6054 | 13.7 | 4.2 | 15.5 | 100 | DEPH3180(1)A5N00 | LDEPH3180(1)A5N00 |
| 630 | 200 | 0.22 | H | 6054 | 13.7 | 4.9 | 15.5 | 100 | DEPH3220(1)A5N00 | LDEPH3220(1)A5N00 |
| 630 | 200 | 0.27 | H | 6054 | 13.7 | 5.7 | 15.5 | 100 | DEPH3270(2)A5N00 | LDEPH3270(2)A5N00 |
| 1000 | 250 | 0.001 | D | 2220 | 5.0 | 1.9 | 6.0 | 300 | DEQD1100(1)A5N00 | LDEQD1100(1)A5N00 |
| 1000 | 250 | 0.0012 | D | 2220 | 5.0 | 2.0 | 6.0 | 300 | DEQD1120(1)A5N00 | LDEQD1120(1)A5N00 |
| 1000 | 250 | 0.0015 | D | 2220 | 5.0 | 2.3 | 6.0 | 300 | DEQD1150(1)A5N00 | LDEQD1150(1)A5N00 |
| 1000 | 250 | 0.0018 | D | 2220 | 5.0 | 2.5 | 6.0 | 300 | DEQD1180(1)A5N00 | LDEQD1180(1)A5N00 |
| 1000 | 250 | 0.0022 | D | 2220 | 5.0 | 2.0 | 6.0 | 300 | DEQD1220(1)A5N00 | LDEQD1220(1)A5N00 |
| 1000 | 250 | 0.0027 | D | 2220 | 5.0 | 2.3 | 6.0 | 300 | DEQD1270(1)A5N00 | LDEQD1270(1)A5N00 |
| 1000 | 250 | 0.0033 | D | 2220 | 5.0 | 2.6 | 6.0 | 300 | DEQD1330(1)A5N00 | LDEQD1330(1)A5N00 |
| 1000 | 250 | 0.0039 | D | 2220 | 5.0 | 3.0 | 6.0 | 300 | DEQD1390(1)A5N00 | LDEQD1390(1)A5N00 |
| 1000 | 250 | 0.0047 | D | 2220 | 5.0 | 3.4 | 6.0 | 300 | DEQD1470(1)A5N00 | LDEQD1470(1)A5N00 |
| 1000 | 250 | 0.0056 | D | 2220 | 5.0 | 3.9 | 6.0 | 300 | DEQD1560(1)A5N00 | LDEQD1560(1)A5N00 |
| VDC | VAC | Capacitance Value (µF) | Size Code | Chip Size | W (mm) | H (mm) | L (mm) | dV/dt (V/µs) | New KEMET Part Number | Legacy Part Number |

(1) K = ±10%, M = ±20%, J = ±5% on request.

(2) Only K and M tolerances available.

Table 1 – Ratings & Part Number Reference cont.

| VDC | VAC | Capacitance Value (µF) | Size Code | Chip Size | Dimensions in mm | | | dV/dt (V/µs) | New KEMET Part Number | Legacy Part Number |
|------|-----|------------------------|-----------|-----------|------------------|---------|--------|--------------|-----------------------|--------------------|
| | | | | | W | H (max) | L | | | |
| 1000 | 250 | 0.0068 | D | 2220 | 5.0 | 4.4 | 6.0 | 300 | DEQD1680(1)A5N00 | LDEQD1680(1)A5N00 |
| 1000 | 250 | 0.0082 | E | 2824 | 6.1 | 2.9 | 7.3 | 300 | DEQE1820(1)A5N00 | LDEQE1820(1)A5N00 |
| 1000 | 250 | 0.010 | E | 2824 | 6.1 | 3.4 | 7.3 | 300 | DEQE2100(1)A5N00 | LDEQE2100(1)A5N00 |
| 1000 | 250 | 0.012 | E | 2824 | 6.1 | 4.0 | 7.3 | 300 | DEQE2120(1)A5N00 | LDEQE2120(1)A5N00 |
| 1000 | 250 | 0.015 | E | 2824 | 6.1 | 4.9 | 7.3 | 300 | DEQE2150(1)A5N00 | LDEQE2150(1)A5N00 |
| 1000 | 250 | 0.018 | E | 2824 | 6.1 | 5.4 | 7.3 | 300 | DEQE2180(1)A5N00 | LDEQE2180(1)A5N00 |
| 1000 | 250 | 0.022 | F | 4030 | 7.9 | 3.4 | 10.5 | 300 | DEQF2220(1)A5N00 | LDEQF2220(1)A5N00 |
| 1000 | 250 | 0.027 | F | 4030 | 7.9 | 4.1 | 10.5 | 300 | DEQF2270(1)A5N00 | LDEQF2270(1)A5N00 |
| 1000 | 250 | 0.033 | F | 4030 | 7.9 | 4.9 | 10.5 | 300 | DEQF2330(1)A5N00 | LDEQF2330(1)A5N00 |
| 1000 | 250 | 0.039 | G | 5040 | 10.4 | 3.5 | 13.0 | 300 | DEQG2390(1)A5N00 | LDEQG2390(1)A5N00 |
| 1000 | 250 | 0.047 | G | 5040 | 10.4 | 4.1 | 13.0 | 300 | DEQG2470(1)A5N00 | LDEQG2470(1)A5N00 |
| 1000 | 250 | 0.056 | G | 5040 | 10.4 | 4.7 | 13.0 | 300 | DEQG2560(1)A5N00 | LDEQG2560(1)A5N00 |
| 1000 | 250 | 0.068 | G | 5040 | 10.4 | 5.5 | 13.0 | 300 | DEQG2680(1)A5N00 | LDEQG2680(1)A5N00 |
| 1000 | 250 | 0.082 | H | 6054 | 13.7 | 4.2 | 15.5 | 300 | DEQH2820(1)A5N00 | LDEQH2820(1)A5N00 |
| 1000 | 250 | 0.1 | H | 6054 | 13.7 | 4.8 | 15.5 | 300 | DEQH3100(1)A5N00 | LDEQH3100(1)A5N00 |
| VDC | VAC | Capacitance Value (µF) | Size Code | Chip Size | W (mm) | H (mm) | L (mm) | dV/dt (V/µs) | New KEMET Part Number | Legacy Part Number |

(1) K = ±10%, M = ±20%, J = ±5% on request.

(2) Only K and M tolerances available.

Soldering Process

| Reflow Recommendations | |
|--|---|
| Preheating | |
| Maximum Preheating Time | 180 seconds |
| Minimum Temperature | 150°C |
| Maximum Temperature | 200°C |
| Solder Flow | |
| Maximum Time within T_{max} and $T_{max} - 5^{\circ}\text{C}$ (ΔT_5) | 30 seconds ($T_{max} \leq 250^{\circ}\text{C}$) |
| | 10 seconds ($250^{\circ}\text{C} < T_{max} \leq 255^{\circ}\text{C}$) |
| Maximum Time Over 217°C (ΔT_{217}) | 150 seconds |
| Maximum Temperature Ramp Rate | 3°C/seconds (heating) |
| | 6°C/seconds (cooling) |
| Second reflow | |
| If two reflow processes are needed, be sure that before the second reflow the temperature on the capacitor's surface is lower than 50°C. | |

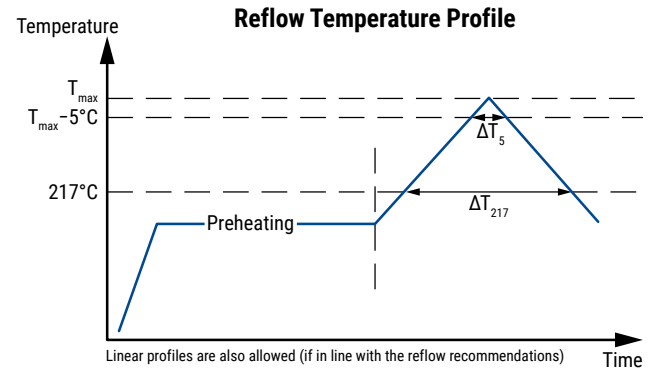

Maximum Temperature on Component Body (T_{max})

| Capacitor | Capacitor Volume (mm^3) | | |
|----------------|------------------------------------|-------------|---------|
| H_{max} (mm) | < 350 | 350 – 2,000 | > 2,000 |
| < 1.6 | 255°C | 255°C | 255°C |
| 1.6 – 2.5 | 255°C | 250°C | 245°C |
| > 2.5 | 250°C | 245°C | 245°C |

*In line with JEDEC STD 020 with some limitations.

Flux/Cleaning/Storage and Moisture

Flux suggestions

KEMET suggests to use a no-clean flux with a halogen content lower than 0.1%.

Cleaning suggestions

To clean the PCB assembly, KEMET recommends using a suitable solvent like Isopropyl alcohol, deionized water, or neutral pH detergents. Aggressive solvents shall not be used. For any different cleaning solvent used, please contact KEMET Technical Services to analyze the potential impact on KEMET products.

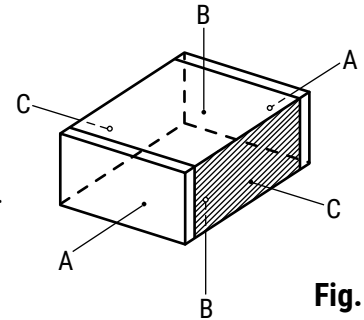

Fig. 1

Storage and moisture recommendations

KEMET SMD Film Capacitors are supplied in a MBB (Moisture Barrier Bag) Class 1. We can guarantee a 24 month shelf life (temperature $\leq 40^{\circ}\text{C}$ /relative humidity $\leq 90\%$). After the MBB has been opened, components may stay in areas with controlled temperature and humidity (temperature $\leq 30^{\circ}\text{C}$ /relative humidity $\leq 60\%$) for 168 hours [MSL 3] (rated voltage ≤ 100 VDC) or 696 hours [MSL 2a] (rated voltage > 100 VDC). For longer periods of time and/or higher temperature and/or higher relative humidity values, it is absolutely necessary to protect the components against humidity. If the reel inside the MBB is partially used, KEMET recommends to re-use the same MBB or avoid areas without controlled temperature and humidity (see above). If the above conditions are not respected, components require baking (minimum time: 48 hours at $55 \pm 5^{\circ}\text{C}$) before the reflow.

Manual assembly recommendations

If PCBs are assembled manually, care must be taken to avoid any mechanical damage to the components.

Our recommendations are the following (see Fig. 1):

- 1) When using tweezers, the components should be gripped across the two terminations (A)
- 2) Avoid any contact with the two cutting surfaces (C)
- 3) A vacuum pen is recommended on the top and bottom surfaces (B)

Flux/Cleaning/Storage and Moisture cont.

Manual soldering recommendations

LDE and LDB series have been designed for Surface Mount Technology, pick-and- place machines, and reflow soldering systems. Issues may occur using a manual soldering iron because the typical temperature for manual soldering is approximately 350°C. Therefore please pay careful attention:

- Never touch the capacitor body with the soldering iron but rather touch the soldering iron and the end termination with the tin wire edge (see Figure 2)
- If the soldering iron is equipped with a temperature controlling device, set the temperature to $250 \pm 3^\circ\text{C}$ and proceed as per Figure 2 (the maximum soldering time, on both terminations, is 5 seconds)
- A soldering iron that is NOT equipped with a temperature controlling device is not an ideal situation and operator experience is extremely important in this case. If you have a soldering iron that does not have a temperature controlling device, please use the following practical suggestions:
 - 1) Proceed as per Figure 2
 - 2) As soon as the tin wire starts melting, move the soldering iron away as quickly as possible
 - 3) Wait a few seconds and check that the soldering joint has been properly created
- If the soldering iron is equipped with a hot air flow device, set the hot air temperature to $250 \pm 3^\circ\text{C}$ and do not send the hot air directly onto the capacitor plastic body. In this situation, the operator's experience is very important.
- In any case, avoid mass-mounting SMD Film Capacitors manually.

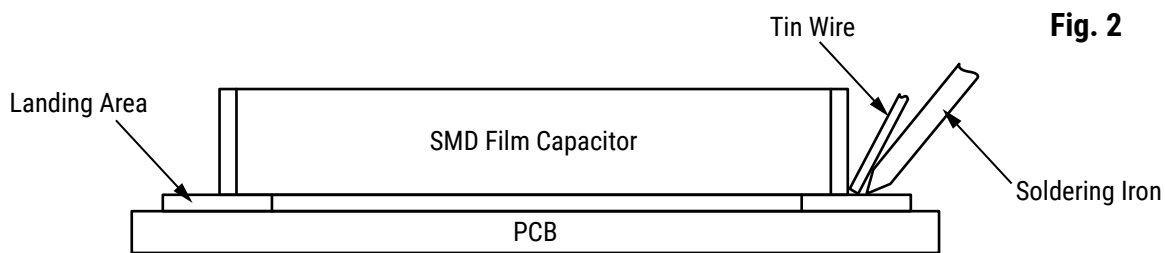

Fig. 2

Packaging Quantities

| Chip Size (EIA) | Height (mm) | Reel |
|-----------------|-------------|-------|
| 1206 | All | 3,000 |
| 1210 | All | 2,250 |
| 1812 | ≤ 1.9 | 4,000 |
| 1812 | 2.1 – 2.6 | 3,000 |
| 2220 | ≤ 2.8 | 3,000 |
| 2220 | 2.9 – 3.7 | 2,250 |
| 2220 | 3.8 – 4.4 | 1,750 |
| 2824 | 2.6 – 3.6 | 2,250 |
| 2824 | 3.8 – 4.4 | 1,750 |
| 2824 | 4.7 – 5.4 | 1,500 |
| 4030 | 2.7 – 3.7 | 1,500 |
| 4030 | 3.9 – 4.5 | 1,250 |
| 4030 | 4.7 – 5.6 | 1,000 |
| 5040 | 3.1 – 3.5 | 1,500 |
| 5040 | 3.8 – 4.4 | 1,250 |
| 5040 | 4.7 – 5.7 | 1,000 |
| 6054 | 3.3 – 4.2 | 1,000 |
| 6054 | 4.5 – 4.9 | 750 |
| 6054 | 5.3 – 5.7 | 750 |

Production Process Basic Suggestions

| In case of: | Typical cause | Typical solution |
|---|---|---|
| No solder joint on one end termination | Landing area dimensions | See landing areas suggestions, page 17 |
| | Solder paste quality | See solder paste suggestions, page 17 |
| | Not-uniform solder paste thickness on the landing areas | Set the dispensing solder paste machine properly |
| | Wrong position of the capacitor on the landing areas | Set the pick and place machine properly |
| | Thermal profile temperature | See reflow recommendations, page 14 |
| | Bad temperature distribution in the reflow oven | Check the reflow oven temperature distribution and variations |
| No solder joint on both end termination | Landing area dimensions | See landing areas suggestions, page 17 |
| | Solder paste quality | See solder paste suggestions, page 17 |
| | No solder paste on the landing areas | Set the dispensing solder paste machine properly |
| | Thermal profile temperature | See reflow recommendations, page 14 |
| | Bad temperature distribution in the reflow oven | Check the reflow oven temperature distribution and variations |
| | Oxidated end terminations | See moisture recommendations, page 15 |
| Capacitor's body mechanical deformation | Too long time over 217°C | See reflow recommendations, page 14 |
| | Too long time within T_{max} and $T_{max} - 5^{\circ}C$ | See reflow recommendations, page 14 |
| | Too high temperature ramp rate | See reflow recommendations, page 14 |
| | Capacitor damaged by a soldering iron | See manual soldering recommendations, page 16 |
| Capacitance drop (up to 20%) | Too long time over 217°C | See reflow recommendations, page 14 |
| | Too long time within T_{max} and $T_{max} - 5^{\circ}C$ | See reflow recommendations, page 14 |
| | Too high temperature ramp rate | See reflow recommendations, page 14 |
| | Capacitor damaged by a soldering iron | See manual soldering recommendations, page 16 |
| Capacitance drop (over 20%) | Capacitor damaged by a soldering iron | See manual soldering recommendations, page 16 |

Note: Small fissures on the capacitor's cutting surface are actually slight detachments of two adjacent metallized film layers and have to be considered only as an aesthetic issue related to the SMD Film Capacitors' manufacturing process and technology.

Therefore, small fissures on SMD Film Capacitors are not comparable to cracks on SMD Ceramics.

Fissures do not influence SMD Film Capacitors' reliability in any way.

Carrier Taping & Packaging (IEC 60286-3)

Horizontal Taping Orientation

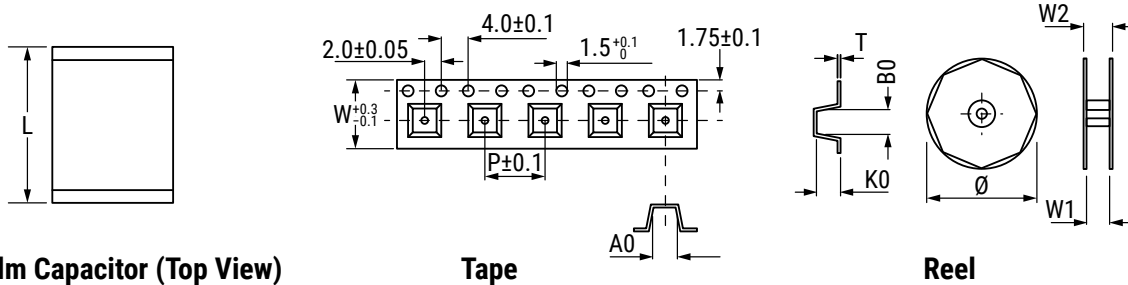

SMD Film Capacitor (Top View)

Tape

Reel

| Chip Size (EIA) Horizontal Mounting | Dimensions in mm | | | Taping Specification | | | | | | | |
|---|------------------|-----------|---------|----------------------|----------------|----------------|----------------|----------------|------|----------------|----------------|
| | W | H | L | W | P ₁ | A ₀ | B ₀ | K ₀ | D | W ₁ | W ₂ |
| | Nominal | Nominal | Nominal | -0.1/+0.3 | ±0.1 | Nominal | Nominal | Nominal | ±2.0 | -0/+2 | Maximum |
| 1206 | 1.7 | All | 3.3 | 8.0 | 4.0 | 2.0 | 3.8 | 1.3 | 180 | 8.0 | 12.0 |
| 1210 | 2.5 | All | 3.3 | 8.0 | 4.0 | 3.0 | 3.8 | 2.1 | 180 | 8.0 | 12.0 |
| 1812 | 3.3 | ≤ 1.9 | 4.7 | 12.0 | 8.0 | 3.8 | 5.3 | 2.0 | 330 | 12.0 | 16.0 |
| 1812 | 3.3 | 2.1 – 2.6 | 4.7 | 12.0 | 8.0 | 3.9 | 5.2 | 2.6 | 330 | 12.0 | 16.0 |
| 2220 | 5.0 | ≤ 2.8 | 6.0 | 12.0 | 8.0 | 5.5 | 6.5 | 2.9 | 330 | 12.0 | 16.0 |
| 2220 | 5.0 | 2.9 – 3.7 | 6.0 | 12.0 | 8.0 | 5.5 | 6.5 | 3.8 | 330 | 12.0 | 16.0 |
| 2220 | 5.0 | 3.8 – 4.4 | 6.0 | 12.0 | 8.0 | 5.5 | 6.5 | 4.9 | 330 | 12.0 | 16.0 |
| 2824 | 6.1 | 2.6 – 3.6 | 7.3 | 16.0 | 8.0 | 6.6 | 7.9 | 3.8 | 330 | 16.0 | 20.0 |
| 2824 | 6.1 | 3.8 – 4.4 | 7.3 | 16.0 | 8.0 | 6.6 | 7.9 | 4.6 | 330 | 16.0 | 20.0 |
| 2824 | 6.1 | 4.7 – 5.4 | 7.3 | 16.0 | 8.0 | 6.6 | 7.9 | 5.5 | 330 | 16.0 | 20.0 |
| 4030 | 7.9 | 2.7 – 3.7 | 10.5 | 16.0 | 12.0 | 8.6 | 11.0 | 3.8 | 330 | 16.0 | 20.0 |
| 4030 | 7.9 | 3.9 – 4.5 | 10.5 | 16.0 | 12.0 | 8.6 | 11.0 | 4.6 | 330 | 16.0 | 20.0 |
| 4030 | 7.9 | 4.7 – 5.6 | 10.5 | 16.0 | 12.0 | 8.6 | 11.0 | 5.8 | 330 | 16.0 | 20.0 |
| 5040 | 10.4 | 3.1 – 3.5 | 13.0 | 24.0 | 12.0 | 10.9 | 13.5 | 3.8 | 330 | 24.0 | 28.0 |
| 5040 | 10.4 | 3.8 – 4.4 | 13.0 | 24.0 | 12.0 | 10.9 | 13.5 | 4.7 | 330 | 24.0 | 28.0 |
| 5040 | 10.4 | 4.7 – 5.7 | 13.0 | 24.0 | 12.0 | 11.0 | 13.5 | 5.9 | 330 | 24.0 | 28.0 |
| 6054 | 13.7 | 3.3 – 4.2 | 15.5 | 24.0 | 16.0 | 14.4 | 16.0 | 4.3 | 330 | 24.0 | 28.0 |
| 6054 | 13.7 | 4.5 – 4.9 | 15.5 | 24.0 | 16.0 | 14.4 | 16.0 | 5.1 | 330 | 24.0 | 28.0 |
| 6054 | 13.7 | 5.3 – 5.7 | 15.5 | 24.0 | 16.0 | 14.4 | 16.0 | 5.8 | 330 | 24.0 | 28.0 |

In accordance with IEC 60286-3

Materials:

- carrier tape: antistatic material
- cover tape: polyester + polythene
- reel: recyclable polystyrene

All parts in reels are packed in hermetically sealed Moisture Barrier Bag (MBB) Class 1.

KEMET Electronics Corporation Sales Offices

For a complete list of our global sales offices, please visit www.kemet.com/sales.

Disclaimer

All product specifications, statements, information and data (collectively, the "Information") in this datasheet are subject to change. The customer is responsible for checking and verifying the extent to which the Information contained in this publication is applicable to an order at the time the order is placed. All Information given herein is believed to be accurate and reliable, but it is presented without guarantee, warranty, or responsibility of any kind, expressed or implied.

Statements of suitability for certain applications are based on KEMET Electronics Corporation's ("KEMET") knowledge of typical operating conditions for such applications, but are not intended to constitute – and KEMET specifically disclaims – any warranty concerning suitability for a specific customer application or use. The Information is intended for use only by customers who have the requisite experience and capability to determine the correct products for their application. Any technical advice inferred from this Information or otherwise provided by KEMET with reference to the use of KEMET's products is given gratis, and KEMET assumes no obligation or liability for the advice given or results obtained.

Although KEMET designs and manufactures its products to the most stringent quality and safety standards, given the current state of the art, isolated component failures may still occur. Accordingly, customer applications which require a high degree of reliability or safety should employ suitable designs or other safeguards (such as installation of protective circuitry or redundancies) in order to ensure that the failure of an electrical component does not result in a risk of personal injury or property damage.

Although all product-related warnings, cautions and notes must be observed, the customer should not assume that all safety measures are indicated or that other measures may not be required.

KEMET is a registered trademark of KEMET Electronics Corporation.

Mouser Electronics

Authorized Distributor

Click to View Pricing, Inventory, Delivery & Lifecycle Information:

KEMET:

[LDEDD4100JA0N00](#) [LDEPD2100JA5N00](#) [LDECB3100KA0N00](#) [LDECD3470KA5N00](#) [LDECD4100KA0N00](#)
[LDEDC3100KA5N00](#) [LDEEC3100KA5N00](#) [LDEID3100KA0N00](#) [LDEPD2100KA5N00](#) [LDECA2100JA0N00](#)
[LDECA2220JA0N00](#) [LDECB3100JA0N00](#) [LDECD3270JA5N00](#) [LDECD3470JA5N00](#) [LDECE4100KA5N00](#)
[LDEDB3100JA0N00](#) [LDEDC3220JA5N00](#) [LDEDC3220KA5N00](#) [LDEDD3330JA5N00](#) [LDEDD3680JA5N00](#)
[LDEDD3680KA5N00](#) [LDEDE4100KA5N00](#) [LDEEB2220JA0N00](#) [LDEEC2470JA5N00](#) [LDEEC3100JA5N0](#)
[LDEEC3100JA5N00](#) [LDEEE3470KA5N00](#) [LDEEF4100KA5N00](#) [LDEEH4470KA5N0](#) [LDEEH4470KA5N00](#)
[LDEIC2330JA0N00](#) [LDEID2330JA5N00](#) [LDEID2680JA5N00](#) [LDEID3100JA0N00](#) [LDEIF3220KA5N00](#)
[LDEIH4150MA0N00](#) [LDEMD2220JA5N00](#) [LDEMD2270JA5N00](#) [LDEME3100JA5N00](#) [LDEMF3150JA5N00](#)
[LDEPH3270KA5N00](#) [LDEDC3100JA5N00](#) [LDEEF4100JA5N00](#) [LDEEA1560KA0N00](#) [LDEPH3270KA5N](#)
[LDEPF3100KA5N](#) [LDEPH3200KA5N00](#) [LDEEE4100KA0N00](#) [LDEIE3100KA5N00](#) [LDEIE3150KA5N00](#)
[LDEDE4100JA5N00](#) [LDECC2470JA5N00](#) [LDEPH3220KA5N0](#) [LDEID2470JA5N00](#) [LDEED3470JA0N00](#)
[LDEIG3470JA5N00](#) [LDEDC2220KA5N00](#) [LDECD3560JA5N00](#) [LDEMD2330JA5N00](#) [LDEIE3220KA0N00](#)
[LDEPD1100KA5N00](#) [LDEDB3100KA0N00](#) [LDECA2330KA0N00](#) [LDEDG4470KA0N00](#) [LDEQH3100KA5N00](#)
[LDECC2680KA5N00](#) [LDEMD2470KA5N00](#) [LDEQG2680KA5N00](#) [LDEDB2680KA0N00](#) [LDEPF2470KA5N00](#)
[LDECD3330KA5N00](#) [LDEEB2470KA0N00](#) [LDEID2470KA5N00](#) [LDEPE2330KA5N00](#) [LDEEC2680KA5N00](#)
[LDEED3220KA5N00](#) [LDEEF4220KA0N00](#) [LDEIF3470KA0N00](#) [LDEMD2220KA5N00](#) [LDEQG2470KA5N00](#)
[LDEMH3470KA5N00](#) [LDEMG3330KA5N00](#) [LDEMD2330KA5N00](#) [LDEIC2220KA0N00](#) [LDEME2680KA5N00](#)
[LDEDD3330KA5N00](#) [LDEED3330KA5N00](#) [LDEEA2100KA0N00](#) [LDEPF3100KA0N00](#) [LDEMG3220KA5N00](#)
[LDEQE2100KA5N00](#) [LDEDD4100KA0N00](#) [LDEME3100KA5N00](#) [LDEIH4100KA5N00](#) [LDEDA2330KA0N00](#)
[LDEIB2100KA0N00](#) [LDECG4470KA0N00](#) [LDEED3470KA0N00](#) [LDEDE4150KA0N00](#) [LDEIF3330KA5N00](#)