



COAXIAL I/Q Mixer

ZMIQ-653H-E+

50Ω LO Power +18 dBm 18 to 65 GHz 1.85mm Female/2.92mm Female

THE BIG DEAL

- Super Wideband RF & LO, 18 to 65 GHz
- Excellent IF bandwidth, DC to 20 GHz
- High L-R Isolation, 42 dB typ.
- Excellent Input IP3, +25 dBm typ.
- Usable as Up & Down Converter



Generic photo used for illustration purposes only

APPLICATIONS

- 5G mmW and Back Haul Radio
- Test and Measurement
- Satellite Communications
- Radar, EW and ESM Defense Systems

FUNCTIONAL DIAGRAM

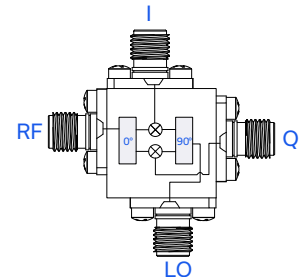

PRODUCT OVERVIEW

Mini-Circuits' ZMIQ-653H-E+ coaxial frequency mixer provides an RF and LO frequency range from 18 to 65 GHz and an IF frequency range from DC to 20 GHz. This device is usable as I and Q modulator/demodulator, image reject mixer and single-sideband mixer. The mixer comes housed in a rugged, 1.85 mm / 2.92 mm connectorized housing suitable for assembled systems and lab use.

The ZMIQ-653H-E+ contains Mini-Circuits' [SMIQ-653H-DG+](#) and is suitable for performance evaluation of the I/Q mixer die.

KEY FEATURES

Feature	Advantages
Wide bandwidth, 18 to 65 GHz	Useful in wideband systems and narrowband systems; covers wide variety of standard bands including K, Ka and V band.
Wide I/Q bandwidth, DC to 20 GHz	Usable in first and second down converter applications. Can be used as IQ modulator / demodulator or with external 90 deg hybrids for single sideband up conversion or image reject down conversion.*
High Isolation, L-R, 42 dB typ.	Preserves signal integrity from input to output and reduces undesired signal responses that can interfere with system performance.
High IP3, +25 dBm typ.	Minimizes third order intermodulation distortion and enables high-dynamic range.
1.85mm-F connectorized housing for RF & LO ports and 2.92mm-F for I & Q ports	Ideal for assembled systems and lab use. High-frequency connector mates with 1.85mm and 2.4mm.

* See application configuration on page #7.





COAXIAL

I/Q Mixer

ZMIQ-653H-E+

50Ω LO Power +18 dBm 18 to 65 GHz 1.85mm Female/2.92mm Female

ELECTRICAL SPECIFICATIONS¹ AT +25°C AND LO POWER AT +18dBm²

Parameter	Frequency (GHz)	Min.	Typ.	Max.	Units
Frequency Range, RF		18	—	65	GHz
Frequency Range, LO		18	—	65	GHz
Frequency Range, I/Q		DC	—	20	GHz
Conversion Loss ³	18 - 65	—	14	19	dB
LO to RF Isolation	18 - 65	—	42	—	dB
LO to I/Q Isolation	18 - 65	—	33	—	dB
RF Input at 1 dB Compression	18 - 65	—	+10	—	dBm
Single Sideband Rejection ⁴	18 - 65	—	24	—	dBc
Amplitude Unbalance	18 - 65	—	0.6	—	dB
Phase Unbalance (relative to 90°)	18 - 65	—	5	—	deg
Input IP3	18 - 65	—	+25	—	dBm

1. Performance measured as a Down Converter unless otherwise specified.
2. LO power range: +17 to +19 dBm. See data plots for performance variation over LO power.
3. Conversion Loss at 200 MHz IF, measured at I and Q ports. Increases with IF frequency.
Conversion Loss= RF Power (dBm)-Power at I/Q-Port (dBm)
4. Up Converter, I/Q=200 MHz, measured use external I/Q quadrature hybrid ([ADQ-32+](#)).

ABSOLUTE MAXIMUM RATINGS⁵

Parameter	Ratings
Operating Temperature	-40°C to +85°C
Storage Temperature	-55°C to +100°C
RF/LO Power	24 dBm
DC Current	32 mA

5. Permanent damage may occur if any of these limits are exceeded.





COAXIAL

I/Q Mixer

ZMIQ-653H-E+

Mini-Circuits

50Ω LO Power +18 dBm 18 to 65 GHz 1.85mm Female/2.92mm Female

TYPICAL PERFORMANCE CHARTS

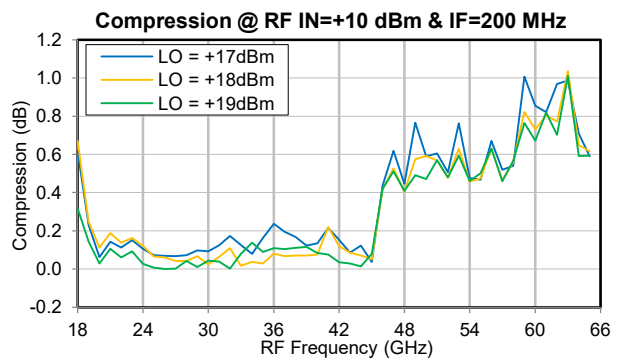
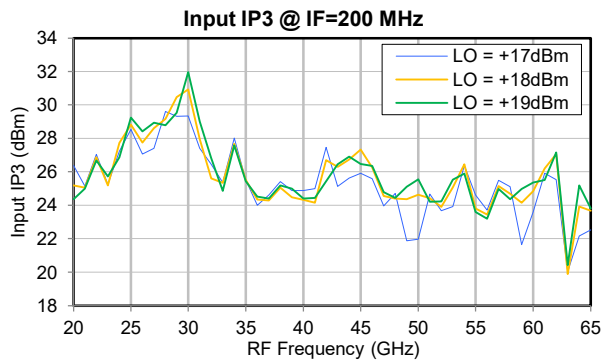
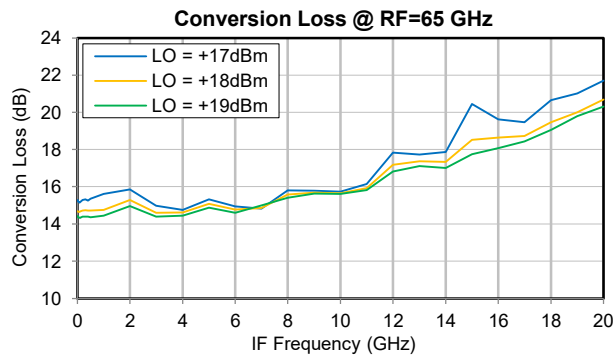
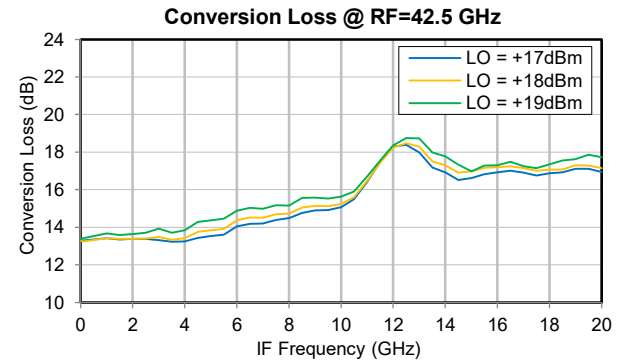
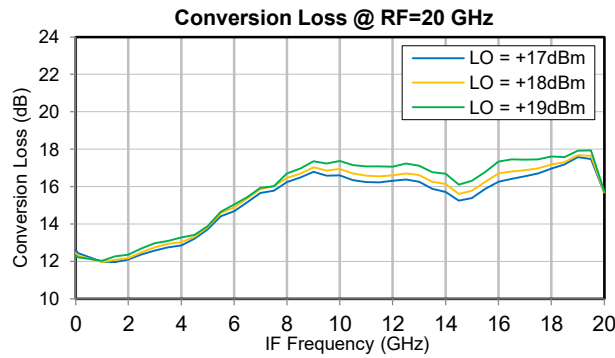
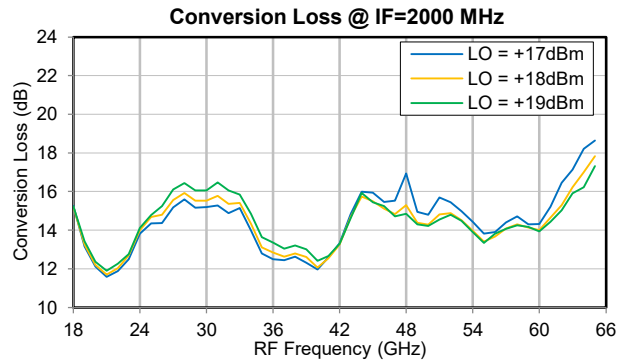
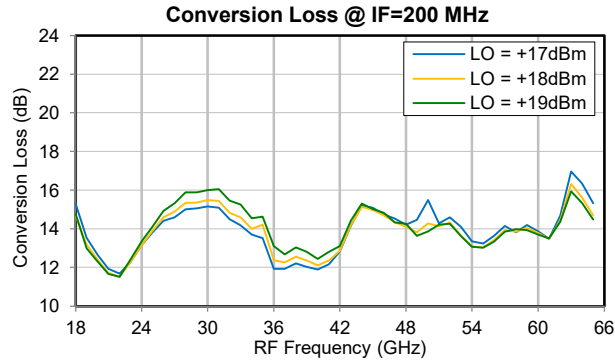



COAXIAL

I/Q Mixer

ZMIQ-653H-E+

Mini-Circuits

50Ω LO Power +18 dBm 18 to 65 GHz 1.85mm Female/2.92mm Female

TYPICAL PERFORMANCE CHARTS

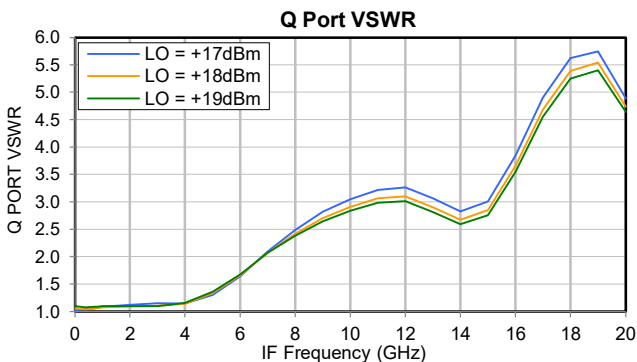
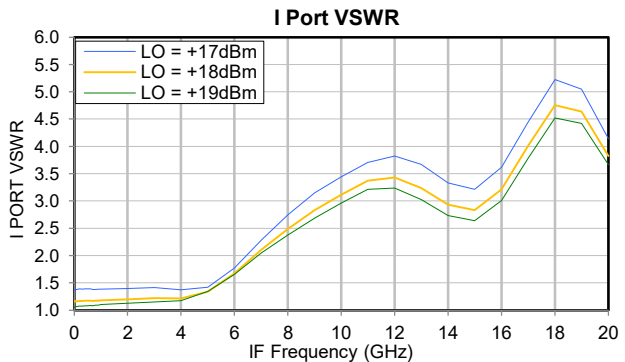
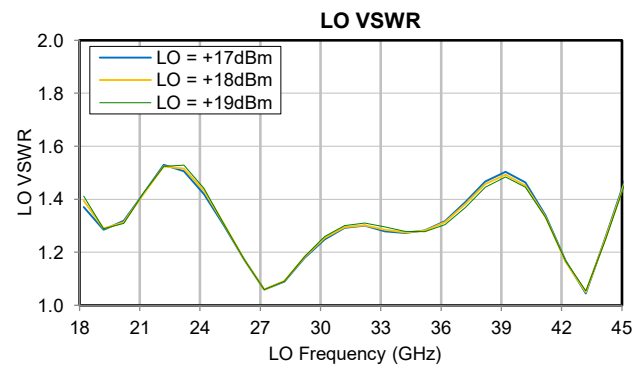
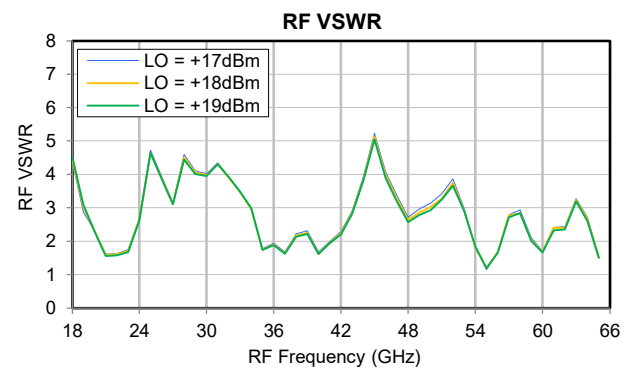
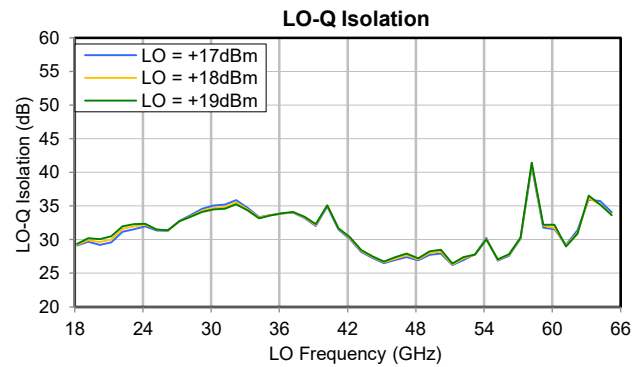
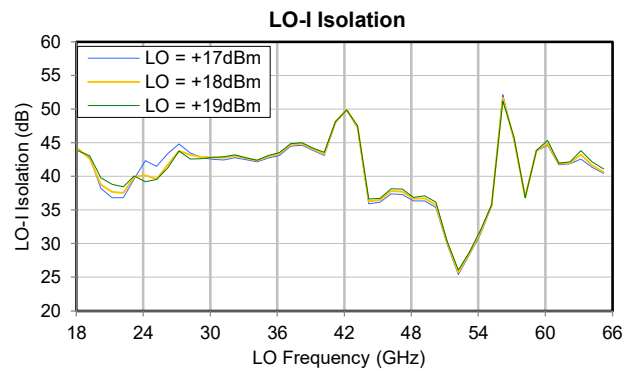
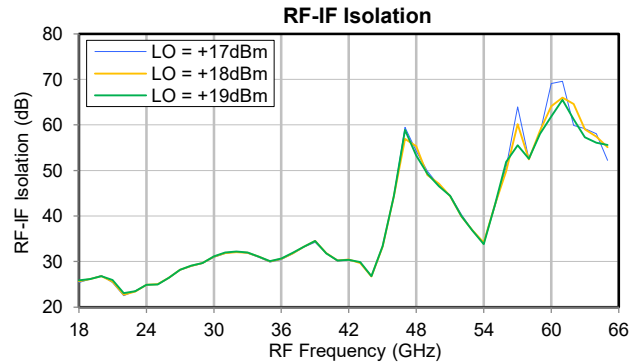
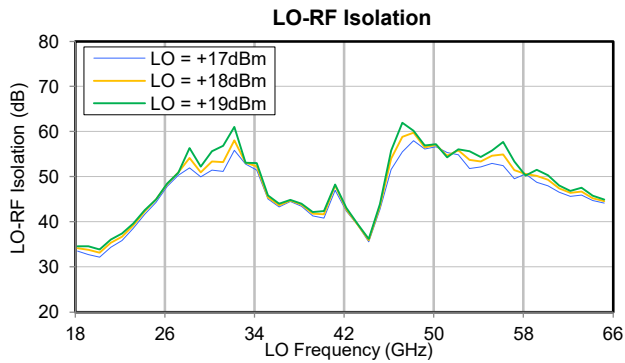



COAXIAL

I/Q Mixer

ZMIQ-653H-E+



50Ω LO Power +18 dBm 18 to 65 GHz 1.85mm Female/2.92mm Female

TYPICAL PERFORMANCE CHARTS

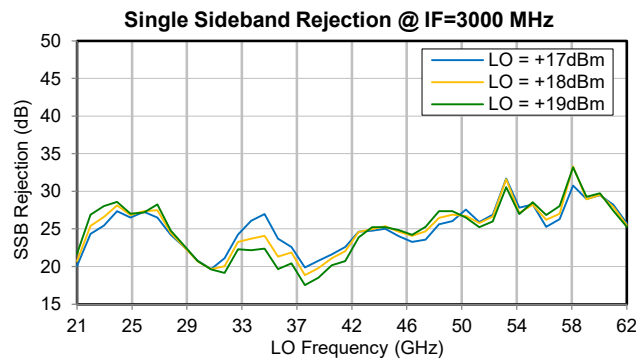
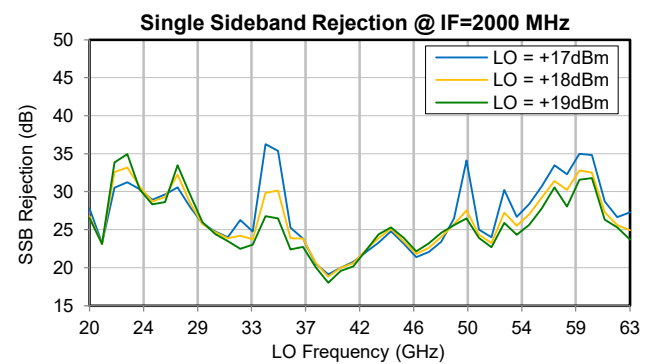
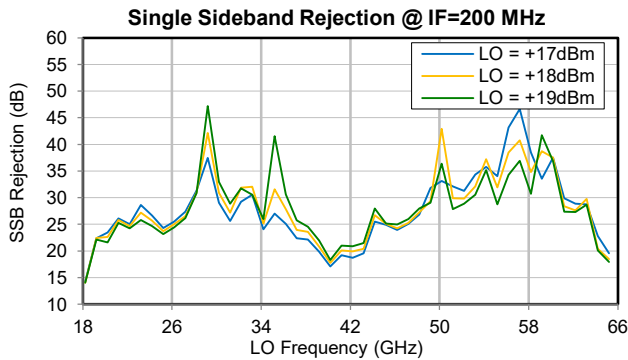
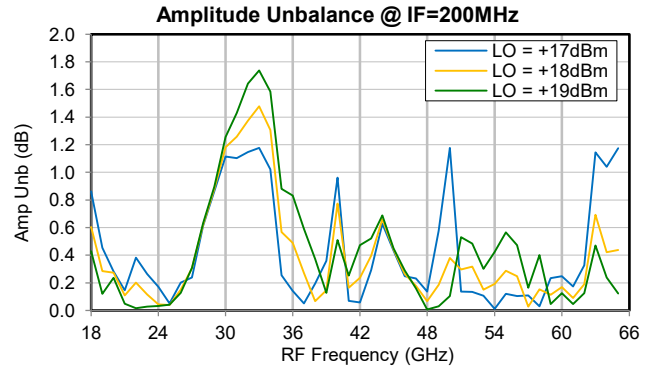
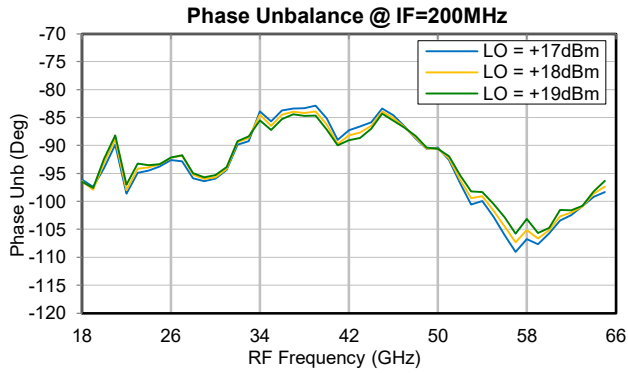



COAXIAL I/Q Mixer

ZMIQ-653H-E+

Mini-Circuits

50Ω LO Power +18 dBm 18 to 65 GHz 1.85mm Female/2.92mm Female

COAXIAL CONNECTIONS

Description	RF PORT	LO PORT	Q PORT	I PORT
Connector Type	1.85mm-F	1.85mm-F	2.92mm-F	2.92mm-F
Port Marking on case style drawing	1	2	3	4

CASE STYLE DRAWING

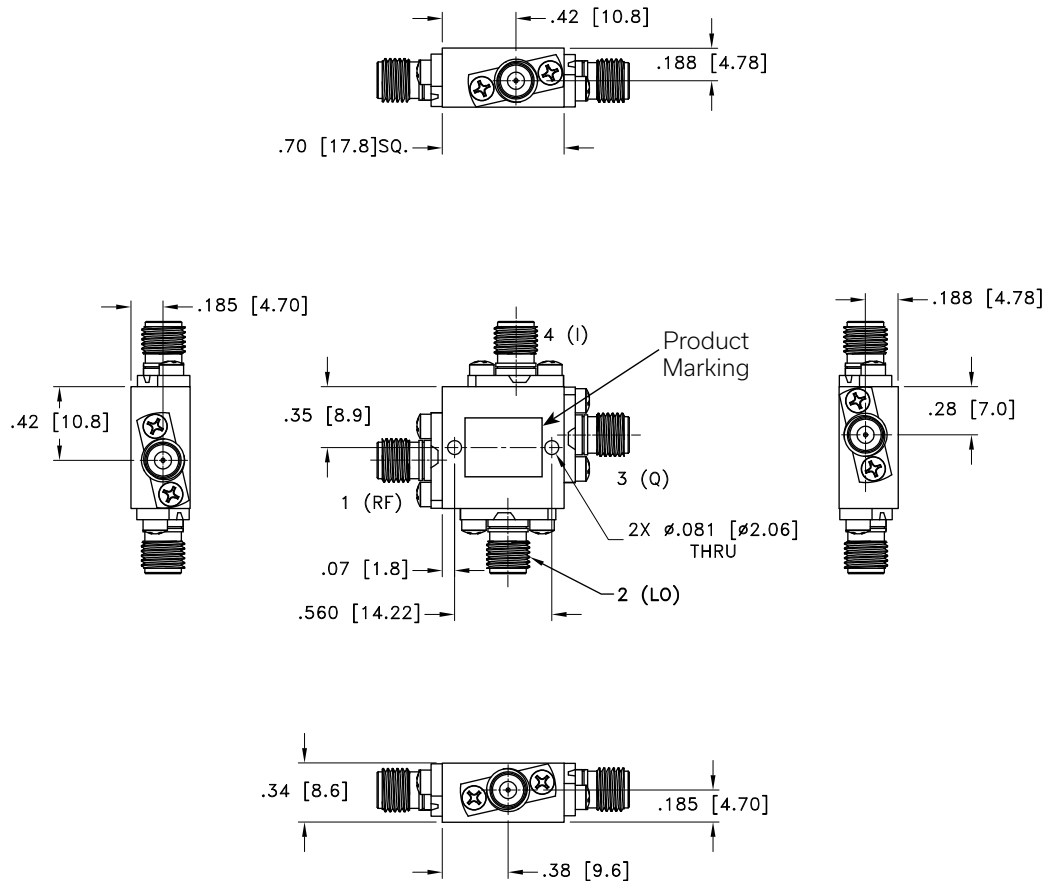

Weight: 28 grams

Dimensions are in inches [mm]. Tolerances: 2 Pl. $\pm .03$; 3 Pl. $\pm .015$ inches

PRODUCT MARKING*: ZMIQ-653H-E+

*Marking may contain other features or characters for internal lot control.





APPLICATION CONFIGURATION FOR IMAGE REJECT AND SINGLE SIDE BAND MIXER

In Image Reject Downconverter or Single Sideband Upconverter applications an external 90° Hybrid is needed. Refer to Mini-Circuits extensive portfolio of 90° Hybrids.

IMAGE REJECT MIXER APPLICATION

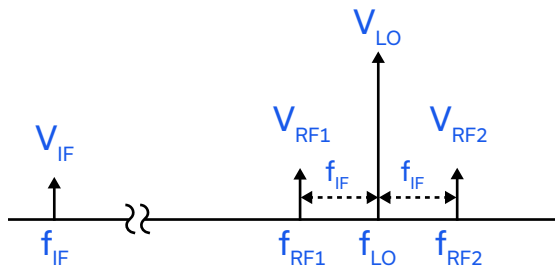

Spectral representation of Signals

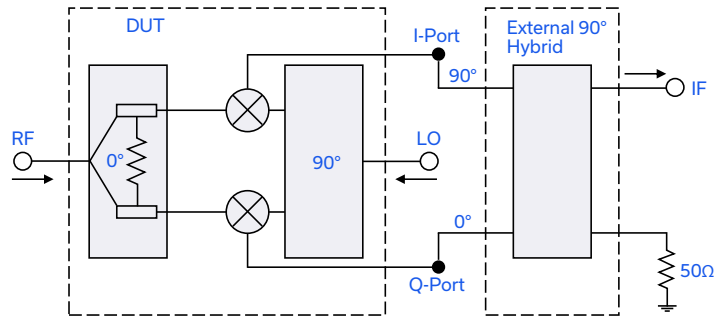

Block Diagram of Image Reject Mixer

If f_{RF1} is the desired signal and f_{RF2} is the image, connect the I port of DUT to the 90° port of the external hybrid and the Q port to the 0° port of the hybrid. This will send the $f_{RF2} - f_{LO}$ IF signal to the terminated output of the external 90° hybrid and desired IF signal $f_{LO} - f_{RF1}$ to IF port.

If f_{RF2} is the desired signal and f_{RF1} is the image signal, connect the I port of DUT to the 0 deg port of the external 90° hybrid and the Q port to the 90° port of the external hybrid. This will send $f_{LO} - f_{RF1}$ IF signal to the terminated output of the external 90° hybrid and desired IF signal $f_{RF2} - f_{LO}$ to IF port.

SINGLE SIDE BAND (SSB) UPCONVERTER APPLICATION

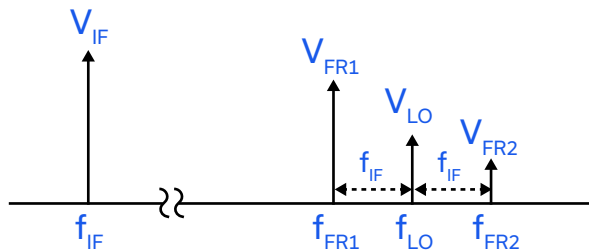

Spectral representation of Signals

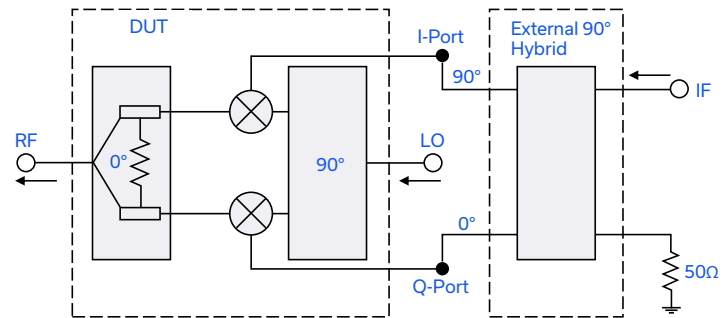

Block Diagram of Single Sideband Upconverter Mixer

For upper side band ($f_{RF2} = f_{LO} + f_{IF}$) selection connect the I port to the 90° port of the external 90° hybrid and the Q port to the 0° port of the external hybrid. This will send the lower sideband band signal ($f_{RF1} = f_{LO} - f_{IF}$) to the isolation resistor of the 0° RF splitter in DUT and upper sideband ($f_{RF2} = f_{LO} + f_{IF}$) to output RF port.

For lower side band ($f_{RF1} = f_{LO} - f_{IF}$) selection connect the I port to the 0° port of the external 90° hybrid and the Q port to the 90° port of the hybrid. This will send the upper sideband band signal ($f_{RF2} = f_{LO} + f_{IF}$) to the isolation resistor of the 0° RF splitter in DUT and lower sideband ($f_{RF1} = f_{LO} - f_{IF}$) to out of RF port.

Refer to Mini-Circuits blog, [I&Q Mixers, Image Reject Down-Conversion & Single Sideband \(SSB\) Up-Conversion](#) for a detailed explanation.



COAXIAL

I/Q Mixer

ZMIQ-653H-E+

Mini-Circuits

50Ω LO Power +18 dBm 18 to 65 GHz 1.85mm Female/2.92mm Female

ADDITIONAL INFORMATION IS AVAILABLE ON OUR DASHBOARD

[CLICK HERE](#)

Performance Data	Data Table Swept Graphs
Case Style	UK3208
RoHs Status	Compliant
Environmental Ratings	ENV131

- NOTES**
- A. Performance and quality attributes and conditions not expressly stated in this specification document are intended to be excluded and do not form a part of this specification document.
 - B. Electrical specifications and performance data contained in this specification document are based on Mini-Circuit's applicable established test performance criteria and measurement instructions.
 - C. The parts covered by this specification document are subject to Mini-Circuits standard limited warranty and terms and conditions (collectively, "Standard Terms"); Purchasers of this part are entitled to the rights and benefits contained therein. For a full statement of the standard. Terms and the exclusive rights and remedies thereunder, please visit Mini-Circuits' website at www.minicircuits.com/terms/viewterm.html



Mouser Electronics

Authorized Distributor

Click to View Pricing, Inventory, Delivery & Lifecycle Information:

[Mini-Circuits:](#)

[ZMIQ-653H-E+](#)