

Low Power, Low Dropout, 500mA RF Linear Regulators

FEATURES

- Low Dropout Voltage
- Thermal-Overload Protection
- Output Current Limit
- 10nA Logic-Controlled Shutdown
- 20 μ A Low Supply Current
- 1.7V to 7.5V Input Voltage Range
- 500mA Output Current
- -40°C to +85°C Operating Temperature Range
- Available in Green UTDFN-1x1-4, SOT23-5, SOT353(SC70-5) Package

APPLICATIONS

- Cellular Telephones
- Camera Modules
- Modems
- HiFi Audio Radio Transceivers
- PLL/Synthesizer, Clocking
- Medium-Current, Noise-Sensitive Applications

DESCRIPTION

The RS3236 series low-power, low-dropout, CMOS LDO operate from 1.7V to 7.5V input voltage that can supply up to 500 mA of output current. Designed to meet the requirements of RF and analog circuits, the RS3236 series device provides low noise, high PSRR, low quiescent current, and low line and load transient response.

The device is designed to work with a 1- μ F input and a 1- μ F output ceramic capacitor (no separate noise bypass capacitor required). An external noise bypass capacitor connected to the device's BP pin can further reduce the noise level.

Other features include a 10nA logic-controlled shutdown mode, foldback current limit and thermal shutdown protection.

The RS3236 series is available in Green UTDFN-1x1-4, SOT23-5, SOT353(SC70-5) package. It operates over an ambient temperature range of -40°C to +85°C.

Functional Block Diagram

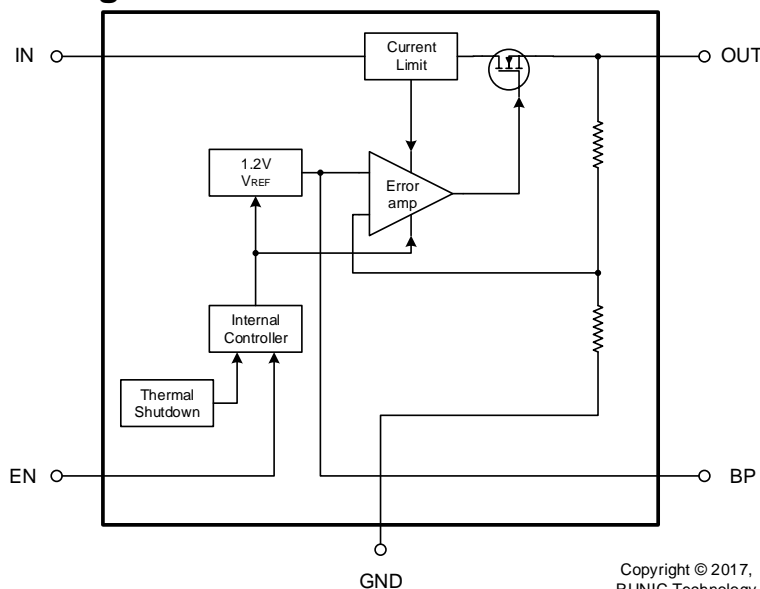

Pin Configuration and Functions (Top View)

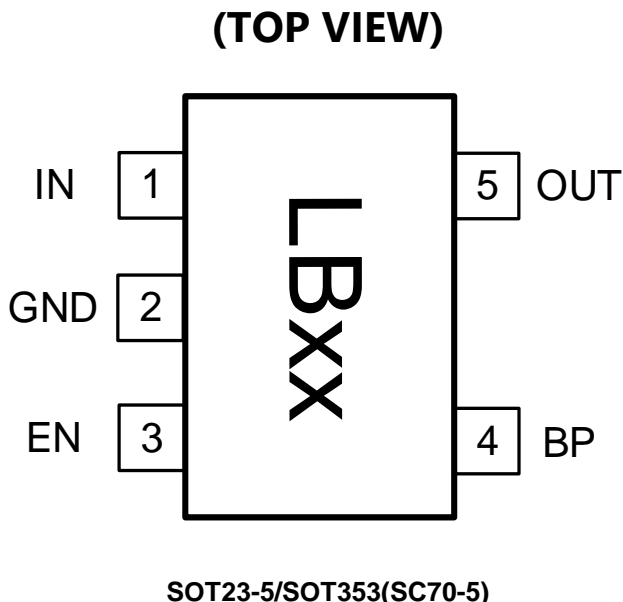
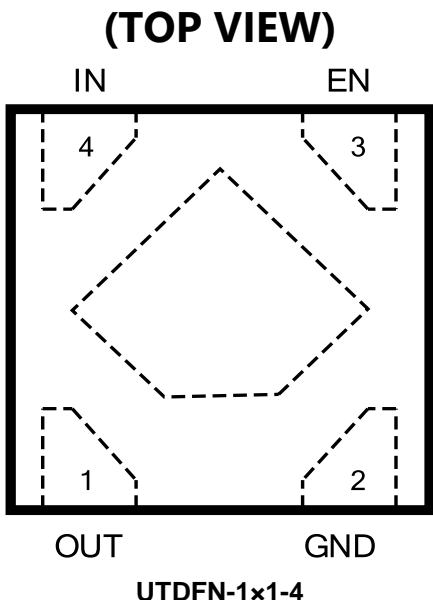

UTDFN-1x1-4		I/O	DESCRIPTION
NUMBER	NAME		
1	OUT	O	Regulator Output.
2	GND	G	Ground.
3	EN	I	Enable Input. A logic low reduces the supply current to 10nA. Connect to IN for normal operation.
4	IN	I	Regulator Input. Supply voltage can range from 1.7V to 7.5V. Bypass with a 1μF capacitor to GND.
Thermal Pad	-	-	Connect the thermal pad to a large-area ground plane. This pad is not an electrical connection to the device ground.

SOT23-5 /SOT353(SC70-5)		I/O	DESCRIPTION
NUMBER	NAME		
1	IN	I	Regulator Input. Supply voltage can range from 1.7V to 7.5V. Bypass with a 1μF capacitor to GND.
2	GND	G	Ground.
3	EN	I	Enable Input. A logic low reduces the supply current to 10nA. Connect to IN for normal operation.
4	BP	O	Reference-Noise Bypass (fixed voltage version only). Bypass with a low-leakage 0.01μF ceramic capacitor for reduced noise at the output. The capacitor is recommended to be placed very close to the pin for high PSRR.
5	OUT	O	Regulator Output.



PACKAGE/ORDERING INFORMATION

MODEL	VOUT (V)	PIN-PACKAGE	ORDERING NUMBER	PACKAGE MARKING	PACKAGE OPTION
RS3236-0.8	0.8V	UTDFN-1x1-4	RS3236-0.8YUTDN4	BA	Tape and Reel, 10000
RS3236-1.0	1.0V	UTDFN-1x1-4	RS3236-1.0YUTDN4	BB	Tape and Reel, 10000
RS3236-1.2	1.2V	UTDFN-1x1-4	RS3236-1.2YUTDN4	BC	Tape and Reel, 10000
RS3236-1.5	1.5V	UTDFN-1x1-4	RS3236-1.5YUTDN4	BD	Tape and Reel, 10000
RS3236-1.8	1.8V	UTDFN-1x1-4	RS3236-1.8YUTDN4	BE	Tape and Reel, 10000
RS3236-2.05	2.05V	UTDFN-1x1-4	RS3236-2.0YUTDN4	BF	Tape and Reel, 10000
RS3236-2.5	2.5V	UTDFN-1x1-4	RS3236-2.5YUTDN4	BG	Tape and Reel, 10000
RS3236-2.8	2.8V	UTDFN-1x1-4	RS3236-2.8YUTDN4	BH	Tape and Reel, 10000
RS3236-3.0	3.0V	UTDFN-1x1-4	RS3236-3.0YUTDN4	BI	Tape and Reel, 10000
RS3236-3.3	3.3V	UTDFN-1x1-4	RS3236-3.3YUTDN4	BJ	Tape and Reel, 10000
RS3236-3.6	3.6V	UTDFN-1x1-4	RS3236-3.6YUTDN4	BK	Tape and Reel, 10000
RS3236-4.0	4.0V	UTDFN-1x1-4	RS3236-4.0YUTDN4	BL	Tape and Reel, 10000
RS3236-5.0	5.0V	UTDFN-1x1-4	RS3236-5.0YUTDN4	BM	Tape and Reel, 10000
RS3236-0.8	0.8V	SOT23-5	RS3236-0.8YF5	LB08	Tape and Reel, 3000
RS3236-1.0	1.0V	SOT23-5	RS3236-1.0YF5	LB10	Tape and Reel, 3000
RS3236-1.2	1.2V	SOT23-5	RS3236-1.2YF5	LB12	Tape and Reel, 3000
RS3236-1.5	1.5V	SOT23-5	RS3236-1.5YF5	LB15	Tape and Reel, 3000
RS3236-1.8	1.8V	SOT23-5	RS3236-1.8YF5	LB18	Tape and Reel, 3000
RS3236-2.05	2.05V	SOT23-5	RS3236-2.0YF5	LB20	Tape and Reel, 3000
RS3236-2.5	2.5V	SOT23-5	RS3236-2.5YF5	LB25	Tape and Reel, 3000
RS3236-2.8	2.8V	SOT23-5	RS3236-2.8YF5	LB28	Tape and Reel, 3000
RS3236-3.0	3.0V	SOT23-5	RS3236-3.0YF5	LB30	Tape and Reel, 3000
RS3236-3.3	3.3V	SOT23-5	RS3236-3.3YF5	LB33	Tape and Reel, 3000
RS3236-3.6	3.6V	SOT23-5	RS3236-3.6YF5	LB36	Tape and Reel, 3000
RS3236-4.0	4.0V	SOT23-5	RS3236-4.0YF5	LB40	Tape and Reel, 3000
RS3236-5.0	5.0V	SOT23-5	RS3236-5.0YF5	LB50	Tape and Reel, 3000
RS3236-0.8	0.8V	SOT353(SC70-5)	RS3236-0.8YC5	LB08	Tape and Reel, 3000
RS3236-1.0	1.0V	SOT353(SC70-5)	RS3236-1.0YC5	LB10	Tape and Reel, 3000
RS3236-1.2	1.2V	SOT353(SC70-5)	RS3236-1.2YC5	LB12	Tape and Reel, 3000
RS3236-1.5	1.5V	SOT353(SC70-5)	RS3236-1.5YC5	LB15	Tape and Reel, 3000
RS3236-1.8	1.8V	SOT353(SC70-5)	RS3236-1.8YC5	LB18	Tape and Reel, 3000
RS3236-2.05	2.05V	SOT353(SC70-5)	RS3236-2.0YC5	LB20	Tape and Reel, 3000
RS3236-2.5	2.5V	SOT353(SC70-5)	RS3236-2.5YC5	LB25	Tape and Reel, 3000
RS3236-2.8	2.8V	SOT353(SC70-5)	RS3236-2.8YC5	LB28	Tape and Reel, 3000
RS3236-3.0	3.0V	SOT353(SC70-5)	RS3236-3.0YC5	LB30	Tape and Reel, 3000
RS3236-3.3	3.3V	SOT353(SC70-5)	RS3236-3.3YC5	LB33	Tape and Reel, 3000
RS3236-3.6	3.6V	SOT353(SC70-5)	RS3236-3.6YC5	LB36	Tape and Reel, 3000
RS3236-4.0	4.0V	SOT353(SC70-5)	RS3236-4.0YC5	LB40	Tape and Reel, 3000
RS3236-5.0	5.0V	SOT353(SC70-5)	RS3236-5.0YC5	LB50	Tape and Reel, 3000

Absolute Maximum Ratings

over operating free-air temperature range (unless otherwise noted) ⁽¹⁾⁽²⁾

		MIN	MAX	UNIT
V _{IN}	Input voltage	-0.3	8	V
V _{EN}	Enable input voltage	-0.3	V _{IN}	V
T _J	Junction temperature		150	°C
P _D	Continuous power dissipation ⁽³⁾	Internally Limited		W
T _{stg}	Storage temperature	-65	150	°C

- (1) Stresses beyond those listed under *Absolute Maximum Ratings* may cause permanent damage to the device. These are stress ratings only, and functional operation of the device at these or any other conditions beyond those indicated under *Recommended Operating Conditions* is not implied. Exposure to absolute-maximum-rated conditions for extended periods may affect device reliability.
- (2) All voltages are with respect to the GND pin.
- (3) Internal thermal shutdown circuitry protects the device from permanent damage.

ESD Ratings

		VALUE	UNIT
V _(ESD)	Electrostatic discharge	Human-body model (HBM)	±6000 V
		Machine model (MM)	±400 V

Recommended Operating Conditions

over operating free-air temperature range (unless otherwise noted) ⁽¹⁾

		MIN	MAX	UNIT
V _{IN}	Input supply voltage	1.7	7.5	V
V _{EN}	Enable input voltage	0	V _{IN}	V
I _{OUT}	Output current	0	500	mA
T _J	Junction temperature	-40	+85	°C

- (1) All voltages are with respect to the GND pin.

Thermal Information

	THERMAL METRIC (1)	RS3236	RS3236	RS3236	UNIT
		UTDFN-1x1-4	SOT353 (SC70-5)	SOT23-5	
		4 PINS	5 PINS	5 PINS	
R _{θJA}	Junction-to-ambient thermal resistance	144.1	268	185.6	°C/W
R _{θJC(top)}	Junction-to-case (top) thermal resistance	137.9	171.8	104.3	°C/W
R _{θJB}	Junction-to-board thermal resistance	83.5	64.5	54.5	°C/W
ψ _{JT}	Junction-to-top characterization parameter	5.3	40.5	31.0	°C/W
ψ _{JB}	Junction-to-board characterization parameter	83.8	62.9	54.5	°C/W
R _{JC(bot)}	Junction-to-case (bottom) thermal resistance	71.8	N/A	N/A	°C/W



ELECTRICAL CHARACTERISTICS

($V_{IN} = V_{OUT(NOMINAL)} + 0.5V$ ⁽¹⁾, Full = -40°C to +85°C, unless otherwise noted.)

PARAMETER	SYMBOL	CONDITIONS		TEMP	MIN	TYP	MAX	UNITS
Input Voltage	V_{IN}			+25°C	1.7 ⁽¹⁾		7.5	V
Output Voltage Accuracy ⁽¹⁾		$I_{OUT} = 0.1mA$		+25°C	-2.5		2.5	%
Maximum Output Current ⁽¹⁾				+25°C	500			mA
Current Limit ⁽¹⁾	I_{LIM}			+25°C	500	800		mA
Ground Pin Current	I_Q	No load		+25°C		15	20	μA
Dropout Voltage ⁽²⁾	V_{DROP}	$I_{OUT} = 300mA$	$V_{OUT}=3.3V$	+25°C		450	550	mV
Line Regulation ⁽¹⁾	ΔV_{LNR}	$V_{IN} = (V_{OUT} + 0.5V)$ to 7.5V, $I_{OUT} = 1mA$		+25°C		0.1	0.2	%/V
Load Regulation	ΔV_{OUT}	$I_{OUT} = 0.1mA$ to 300mA, $C_{OUT} = 1\mu F$,		+25°C		20	40	mV
Output Voltage Noise	e_n	f = 10Hz to 100kHz, $C_{BP} = 0.01\mu F$, $C_{OUT} = 10\mu F$, $I_{OUT}=30mA$		+25°C		80		μ V _{RMS}
Power Supply Rejection Ratio	PSRR	$C_{BP} = 0\mu F$, $I_{LOAD} = 30mA$, $C_{OUT} = 1\mu F$, $V_{IN} = V_{OUT}+1V$ $\Delta V_{RIPPLE}=0.2V_{P-P}$	f = 217Hz	+25°C		72		dB
			f = 1kHz			70		
		$C_{BP} = 0.01\mu F$, $I_{LOAD} = 30mA$, $C_{OUT} = 1\mu F$, $V_{IN} = V_{OUT}+1V$ $\Delta V_{RIPPLE}=0.2V_{P-P}$	f = 217Hz	+25°C		74	dB	
			f = 1kHz			70		
SHUTDOWN								
EN Input Threshold	V_{IH}	$V_{IN} = 1.7V$		Full	1.4			V
	V_{IL}			Full			0.4	
EN Input Threshold	V_{IH}	$V_{IN} = 7.5V$		Full	2.3			V
	V_{IL}			Full			0.8	
EN Input Bias Current	I_{BH}	$EN = 7.5V$		+25°C		0.01	1	μA
	I_{BL}	$EN = 0V$		Full		0.01		
Shutdown Supply Current	$I_{Q(SHDN)}$	$EN = 0V$		Full		0.01	1	μA
Start-Up Time ⁽⁴⁾	t_{STR}	$C_{OUT} = 1\mu F$, No Load		+25°C		180		μs
THERMAL PROTECTION								
Thermal Shutdown Temperature	T_{SHDN}					140		°C

NOTES:

- $V_{IN} = V_{OUT(NOMINAL)} + 0.5V$ or 1.7V, whichever is greater.
- The dropout voltage is defined as $V_{IN} - V_{OUT}$, when V_{OUT} is 100mV below the value of V_{OUT} for $V_{IN} = V_{OUT} + 0.5V$.
- Time needed for V_{OUT} to reach 90% of final value.

TYPICAL APPLICATION CIRCUIT

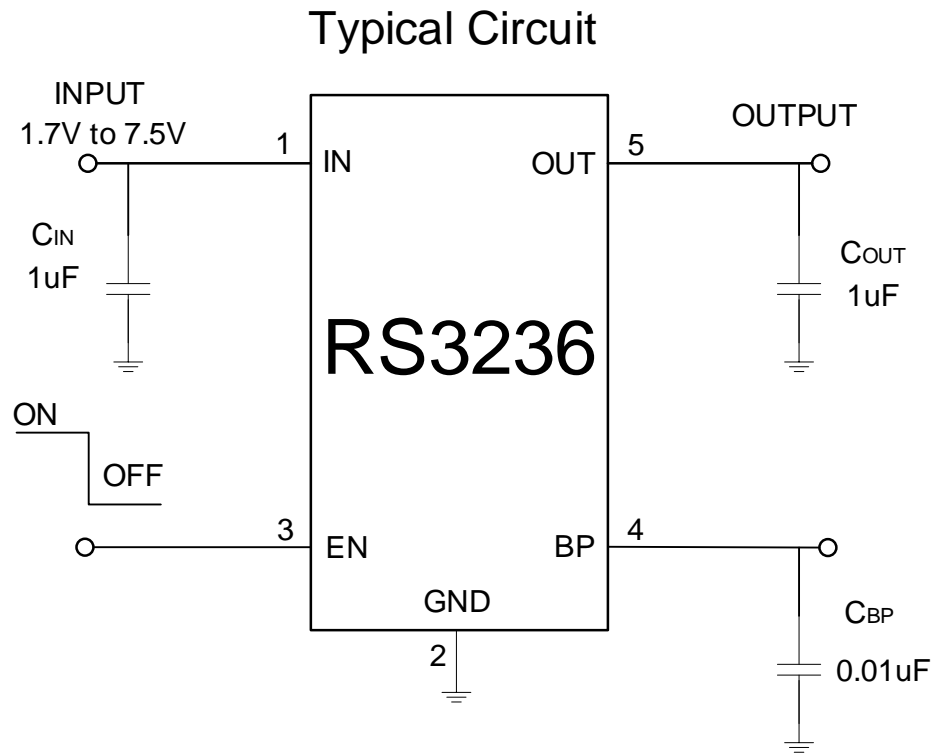

TYPICAL PERFORMANCE CHARACTERISTICS

$V_{IN} = V_{OUT (NOMINAL)} + 0.5V$, $C_{IN} = 1\mu F$, $C_{OUT} = 1\mu F$, $C_{BP} = 0\mu F$, $T_A = +25^\circ C$, unless otherwise noted.

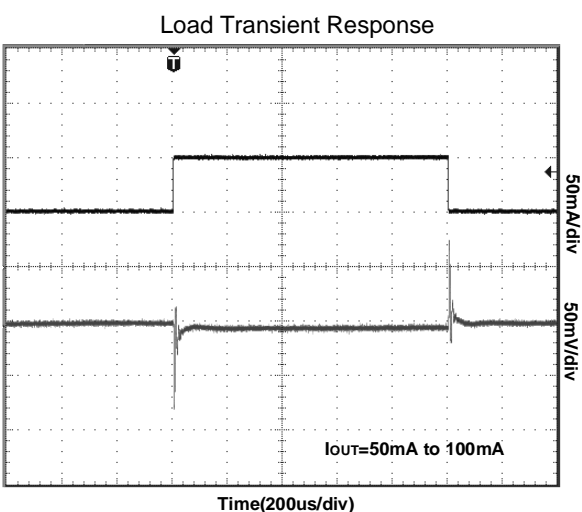
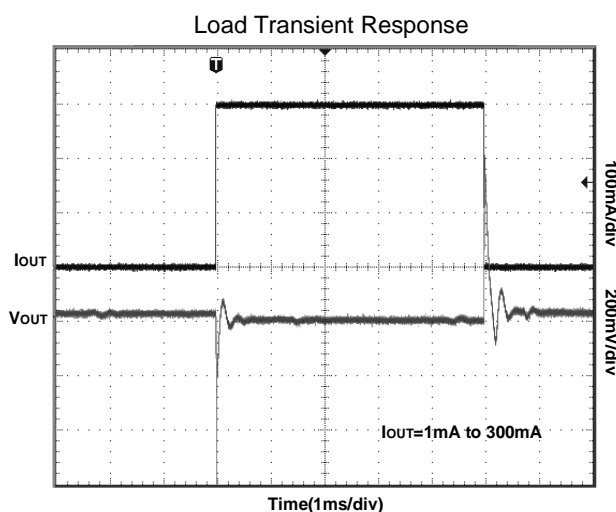
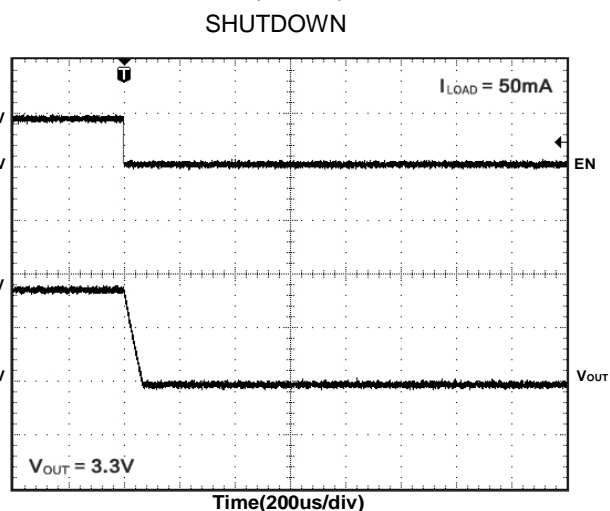
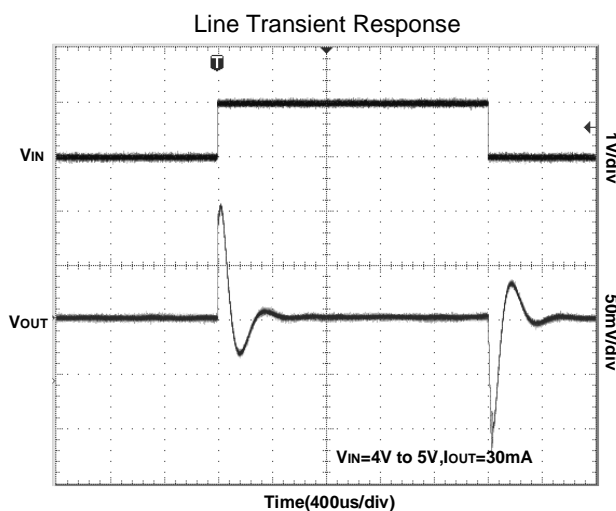
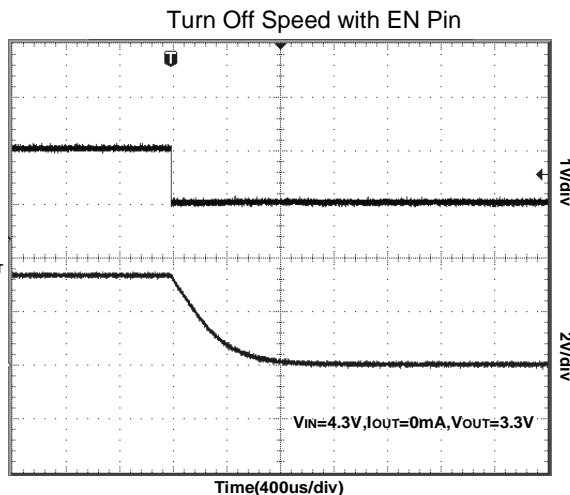
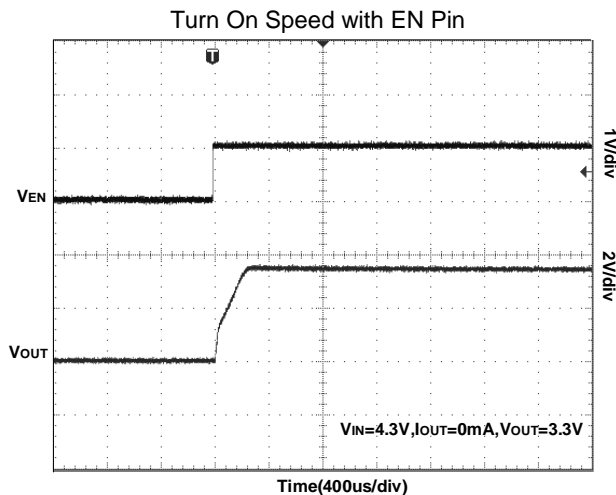

TYPICAL PERFORMANCE CHARACTERISTICS

$V_{IN} = V_{OUT (NOMINAL)} + 0.5V$, $C_{IN} = 1\mu F$, $C_{OUT} = 1\mu F$, $C_{BP} = 0.1\mu F$, $T_A = +25^\circ C$, unless otherwise noted.

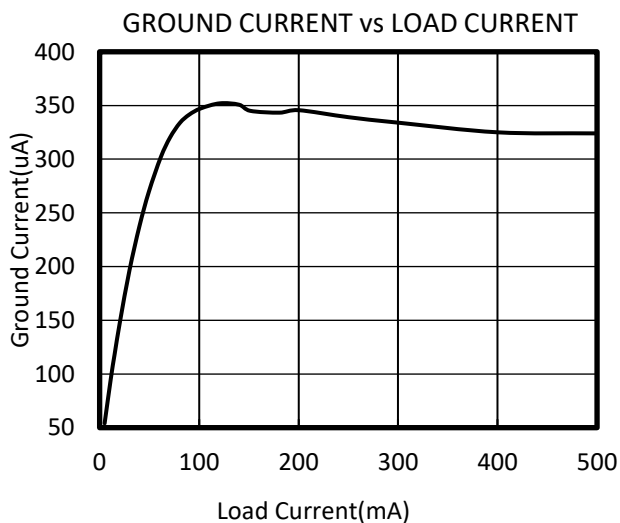
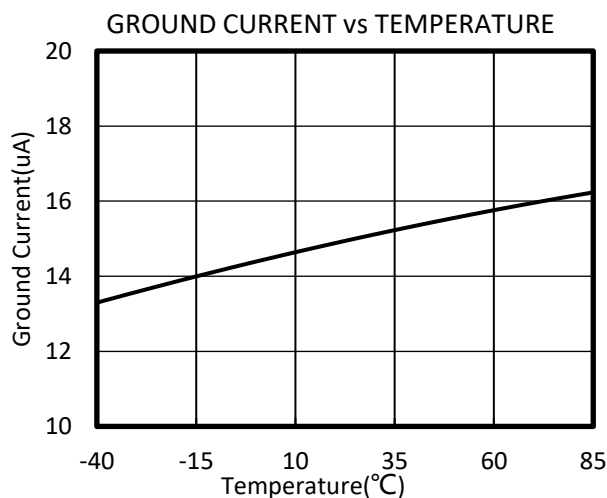
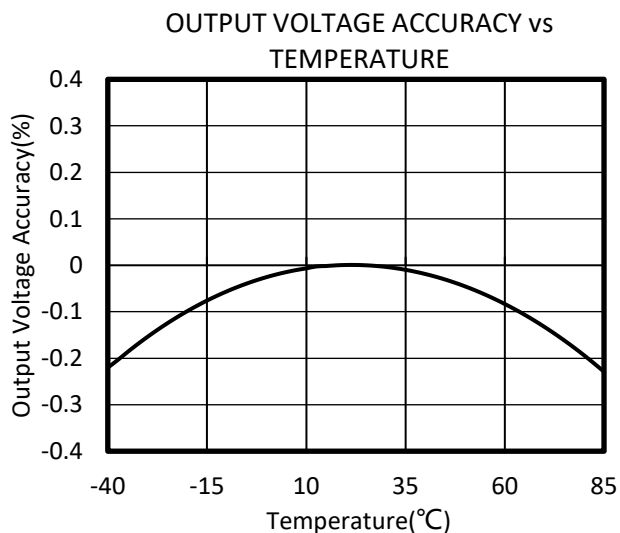
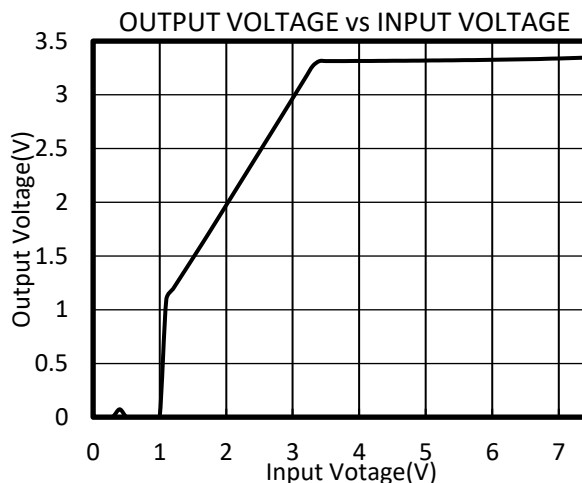
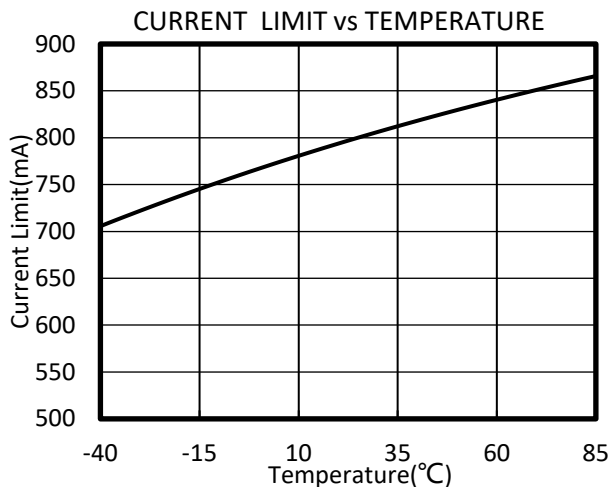

PACKAGE OUTLINE DIMENSIONS

SOT23-5

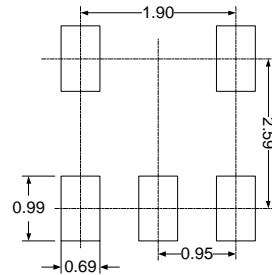
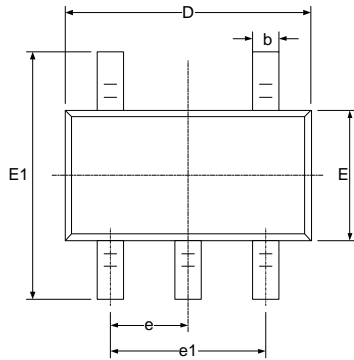

RECOMMENDED LAND PATTERN (Unit: mm)

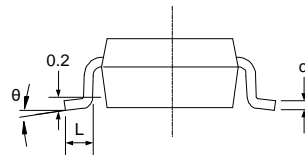
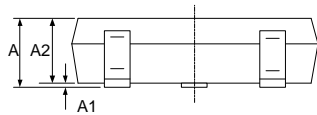

Symbol	Dimensions In Millimeters		Dimensions In Inches	
	Min	Max	Min	Max
A	1.050	1.250	0.041	0.049
A1	0.000	0.100	0.000	0.004
A2	1.050	1.150	0.041	0.045
b	0.300	0.500	0.012	0.020
c	0.100	0.200	0.004	0.008
D	2.820	3.020	0.111	0.119
E	1.500	1.700	0.059	0.067
E1	2.650	2.950	0.104	0.116
e	0.950(BSC)		0.037(BSC)	
e1	1.800	2.000	0.071	0.079
L	0.300	0.600	0.012	0.024
θ	0°	8°	0°	8°

SOT353(SC70-5)

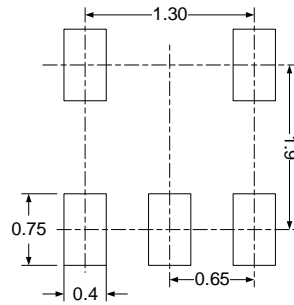
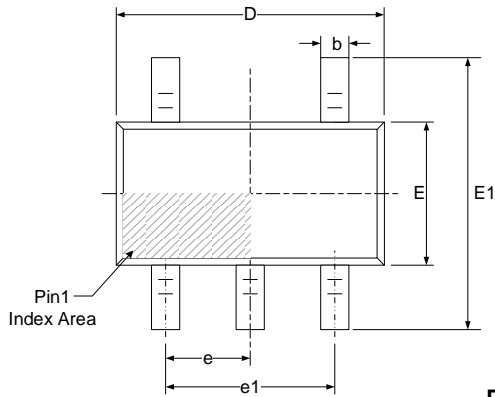

RECOMMENDED LAND PATTERN (Unit: mm)

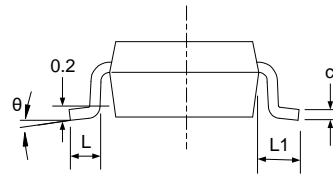
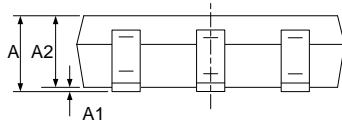

Symbol	Dimensions In Millimeters		Dimensions In Inches	
	Min	Max	Min	Max
A	0.900	1.100	0.035	0.043
A1	0.000	0.100	0.000	0.004
A2	0.900	1.000	0.035	0.039
b	0.150	0.350	0.006	0.014
c	0.080	0.150	0.003	0.006
D	2.000	2.200	0.079	0.087
E	1.150	1.350	0.045	0.053
E1	2.150	2.450	0.085	0.096
e	0.650(BSC)		0.026(BSC)	
e1	1.300(BSC)		0.051(BSC)	
L	0.260	0.460	0.010	0.018
L1	0.525		0.021	
θ	0°	8°	0°	8°

UTDFN-1x1-4

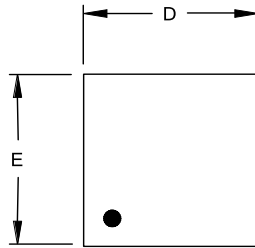

TOP VIEW

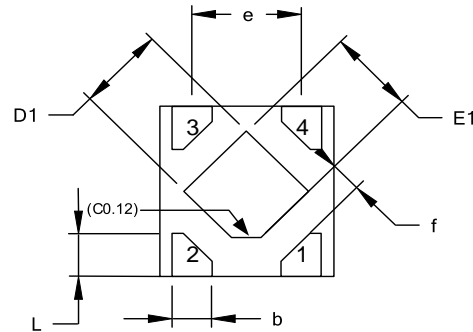

BOTTOM VIEW

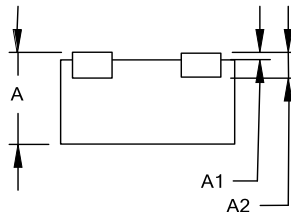

SIDE VIEW

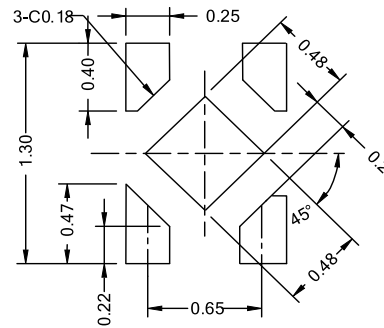

RECOMMENDED LAND PATTERN (Unit: mm)

Symbol	Dimensions In Millimeters		
	MIN	MOD	MAX
A	0.340	0.370	0.400
A1	0.000	0.020	0.050
A2	0.100REF		
D	0.950	1.000	1.050
D1	0.430	0.480	0.530
E	0.950	1.000	1.050
E1	0.430	0.480	0.530
b	0.170	0.220	0.270
e	0.600	0.650	0.700
f	0.195REF		
L	0.200	0.250	0.300