

60V Low I_Q , Triple Output, Buck/Buck/Boost Synchronous Controller

FEATURES

- Dual Buck Plus Single Boost Synchronous Controllers
- Wide Bias Input Voltage Range: 4.5V to 60V
- Outputs Remain in Regulation Through Cold Crank Down to a 2.2V Input Supply Voltage
- Buck and Boost Output Voltages Up to 60V
- Adjustable Gate Drive Level 5V to 10V (OPTI-DRIVE)
- No External Bootstrap Diodes Required
- Low Operating I_Q : 29 μ A (One Channel On)
- 100% Duty Cycle for Boost Synchronous MOSFET
- Phase-Lockable Frequency (75kHz to 850kHz)
- Programmable Fixed Frequency (50kHz to 900kHz)
- Very Low Dropout Operation: 99% Duty Cycle (Bucks)
- Low Shutdown I_Q : 3.6 μ A
- Fixed or Adjustable Boost Output Voltage Saves I_Q
- Small 38-Lead 5mm \times 7mm QFN and TSSOP Packages

APPLICATIONS

- Automotive Always-On and Start-Stop Systems
- Distributed DC Power Systems
- Multioutput Buck-Boost Applications

DESCRIPTION

The **LTC[®]3899** is a high performance triple output (buck/buck/boost) DC/DC switching regulator controller that drives all N-channel synchronous power MOSFET stages. The constant frequency current mode architecture allows a phase-lockable frequency of up to 850kHz. The LTC3899 operates from a wide 4.5V to 60V input supply range. When biased from the output of the boost converter or another auxiliary supply, the LTC3899 can operate from an input supply as low as 2.2V after start-up.

The gate drive for the LTC3899 can be programmed from 5V to 10V to allow the use of logic-level or standard-level FETs and to maximize efficiency. Internal switches in the top gate drivers eliminate the need for external bootstrap diodes. The 29 μ A no-load quiescent current extends operating run time in battery-powered systems. OPTI-LOOP[®] compensation allows the transient response to be optimized over a wide range of output capacitance and ESR values.

LT, LT, LTC, LTM, Burst Mode, OPTI-LOOP, Linear Technology and the Linear logo are registered trademarks of Linear Technology Corporation. All other trademarks are the property of their respective owners. Protected by U.S. Patents including 5481178, 5705919, 5929620, 6144194, 6177787, 6580258.

TYPICAL APPLICATION

High Efficiency Wide Input Range Dual 5V/8.5V Converter

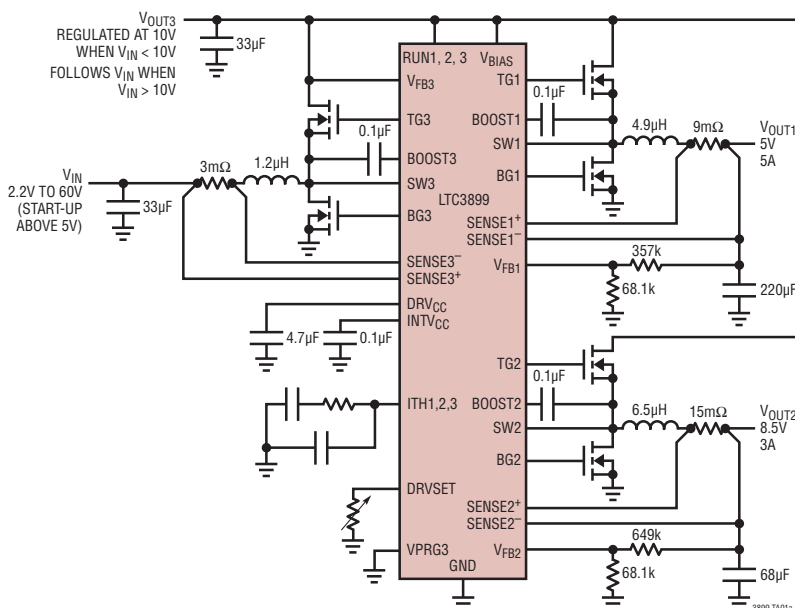

Efficiency vs Output Current

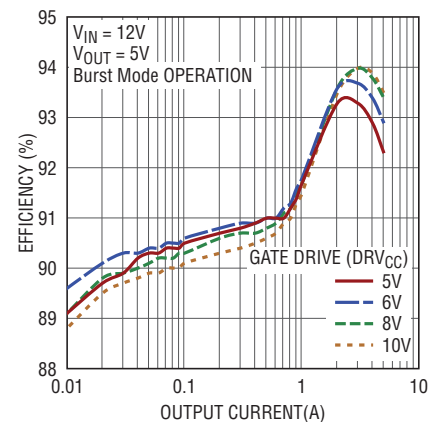

ABSOLUTE MAXIMUM RATINGS (Notes 1, 3)

Bias Input Supply Voltage (V_{BIAS}).....	-0.3V to 65V	PLLIN/MODE, FREQ, DRVSET Voltages	-0.3V to 6V
Topside Driver Voltages		EXTV _{CC} Voltage	-0.3V to 14V
BOOST1, BOOST2, BOOST3	-0.3V to 76V	ITH1, ITH2, ITH3, V_{FB1} , V_{FB2} Voltages	-0.3V to 6V
Switch Voltage (SW1, SW2, SW3)	-5V to 70V	V_{FB3} Voltage.....	-0.3V to 65V
DRV _{CC} , (BOOST1-SW1), (BOOST2-SW2),		VPRG3, Voltage	-0.3V to 6V
(BOOST3-SW3).....	-0.3V to 11V	TRACK/SS1, TRACK/SS2, SS3 Voltages.....	-0.3V to 6V
BG1, BG2, BG3, TG1, TG2, TG3	(Note 8)	Operating Junction Temperature Range (Note 2)	
RUN1, RUN2, RUN3 Voltages.....	-0.3V to 65V	LTC3899E, LTC3899I	-40°C to 125°C
SENSE1 ⁺ , SENSE2 ⁺ , SENSE1 ⁻		LTC3899H.....	-40°C to 150°C
SENSE2 ⁻ Voltages	-0.3V to 65V	LTC3899MP	-55°C to 150°C
SENSE3 ⁺ , SENSE3 ⁻ Voltages	-0.3V to 65V	Storage Temperature Range	-65°C to 150°C

PIN CONFIGURATION

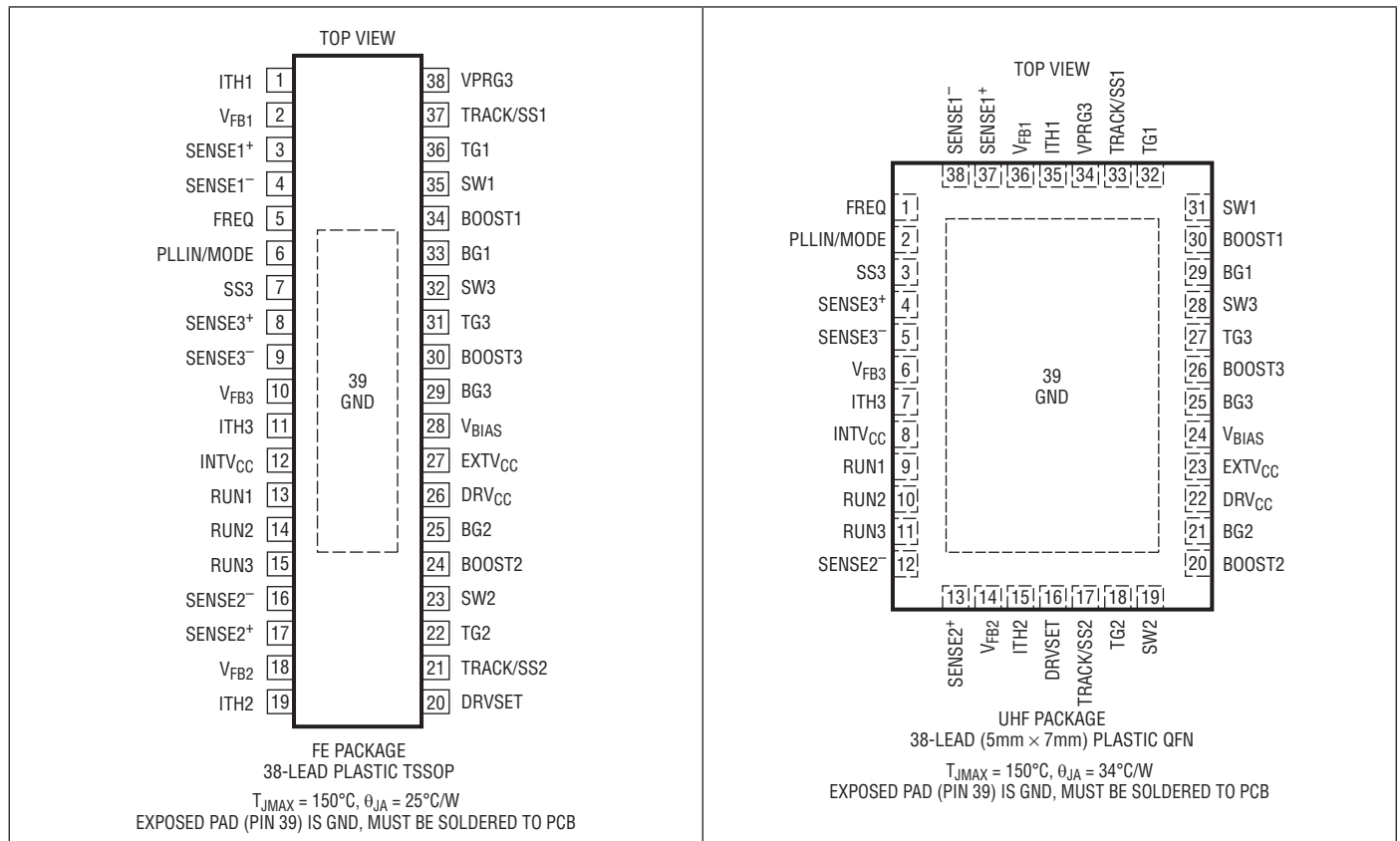

ORDER INFORMATION

LEAD FREE FINISH	TAPE AND REEL	PART MARKING*	PACKAGE DESCRIPTION	TEMPERATURE RANGE
LTC3899EFE#PBF	LTC3899EFE#TRPBF	LTC3899FE	38-Lead Plastic TSSOP	-40°C to 125°C
LTC3899IFE#PBF	LTC3899IFE#TRPBF	LTC3899FE	38-Lead Plastic TSSOP	-40°C to 125°C
LTC3899HFE#PBF	LTC3899HFE#TRPBF	LTC3899FE	38-Lead Plastic TSSOP	-40°C to 150°C
LTC3899MPFE#PBF	LTC3899MPFE#TRPBF	LTC3899FE	38-Lead Plastic TSSOP	-55°C to 150°C
LTC3899EUHF#PBF	LTC3899EUHF#TRPBF	3899	38-Lead (5mm × 7mm) Plastic QFN	-40°C to 125°C
LTC3899IUHF#PBF	LTC3899IUHF#TRPBF	3899	38-Lead (5mm × 7mm) Plastic QFN	-40°C to 125°C
LTC3899HUHF#PBF	LTC3899HUHF#TRPBF	3899	38-Lead (5mm × 7mm) Plastic QFN	-40°C to 150°C
LTC3899MPUHF#PBF	LTC3899MPUHF#TRPBF	3899	38-Lead (5mm × 7mm) Plastic QFN	-55°C to 150°C

Consult LTC Marketing for parts specified with wider operating temperature ranges. *The temperature grade is identified by a label on the shipping container. Consult LTC Marketing for information on nonstandard lead based finish parts.

For more information on lead free part marking, go to: <http://www.linear.com/leadfree/>

For more information on tape and reel specifications, go to: <http://www.linear.com/tapeandreel/>

ELECTRICAL CHARACTERISTICS

The ● denotes the specifications which apply over the specified operating junction temperature range, otherwise specifications are at $T_A = 25^\circ\text{C}$. (Note 2) $V_{\text{BIAS}} = 12\text{V}$, $V_{\text{RUN1,2,3}} = 5\text{V}$, $V_{\text{EXTVCC}} = 0\text{V}$, $V_{\text{DRVSET}} = 0\text{V}$, $V_{\text{PRG3}} = \text{Float}$ unless otherwise noted.

SYMBOL	PARAMETER	CONDITIONS	MIN	TYP	MAX	UNITS
V_{BIAS}	Bias Input Supply Operating Voltage Range		4.5		60	V
$V_{\text{FB1,2}}$	Buck Regulated Feedback Voltage	(Note 4) ITH1,2 Voltage = 1.2V 0°C to 85°C	● 0.792 0.788	0.800 0.800	0.808 0.812	V V
V_{FB3}	Boost Regulated Feedback Voltage	(Note 4) ITH3 Voltage = 1.2V VPRG3 = FLOAT VPRG3 = 0V VPRG3 = INTV _{CC}	● ● ●	1.182 9.78 11.74	1.200 10.00 12.26	V V V
$I_{\text{FB1,2}}$	Buck Feedback Current	(Note 4)		-2	±50	nA
I_{FB3}	Boost Feedback Current	(Note 4) VPRG3 = FLOAT VPRG3 = 0V VPRG3 = INTV _{CC}		±0.01 4 5	±0.05 6 7	μA μA μA
V_{REFLNREG}	Reference Voltage Line Regulation	(Note 4) $V_{\text{BIAS}} = 4.5\text{V}$ to 60V		0.002	0.02	%/V
V_{LOADREG}	Output Voltage Load Regulation	(Note 4) Measured in Servo Loop, ΔITH Voltage = 1.2V to 0.7V	●	0.01	0.1	%
		(Note 4) Measured in Servo Loop, ΔITH Voltage = 1.2V to 2V	●	-0.01	-0.1	%
$g_{\text{m1,2,3}}$	Transconductance Amplifier g_{m}	(Note 4) ITH1,2,3 = 1.2V, Sink/Source 5μA		2		mmho

ELECTRICAL CHARACTERISTICS The ● denotes the specifications which apply over the specified operating junction temperature range, otherwise specifications are at $T_A = 25^\circ\text{C}$. (Note 2) $V_{\text{BIAS}} = 12\text{V}$, $V_{\text{RUN1,2,3}} = 5\text{V}$, $V_{\text{EXTVCC}} = 0\text{V}$, $V_{\text{DRVSET}} = 0\text{V}$, $V_{\text{PRG3}} = \text{Float}$ unless otherwise noted.

SYMBOL	PARAMETER	CONDITIONS	MIN	TYP	MAX	UNITS	
I_Q	Input DC Supply Current	(Note 5), $V_{\text{DRVSET}} = 0\text{V}$					
	Pulse-Skipping or Forced Continuous Mode (One Channel On)	RUN1 = 5V and RUN2,3 = 0V or RUN2 = 5V and RUN1,3 = 0V or RUN3 = 5V and RUN1,2 = 0V, $V_{\text{FB1,2}} = 0.83\text{V}$ (No Load), $V_{\text{FB3}} = 1.25\text{V}$		1.6 1.6 0.8		mA	
	Pulse-Skipping or Forced Continuous Mode (All Channels On)	RUN1,2,3 = 5V, $V_{\text{FB1,2}} = 0.83\text{V}$ (No Load), $V_{\text{FB3}} = 1.25\text{V}$		3		mA	
	Sleep Mode (One Channel On, Buck)	RUN1 = 5V and RUN2,3 = 0V or RUN2 = 5V and RUN1,3 = 0V $V_{\text{FB1,2}} = 0.83\text{V}$ (No Load)	●	29	55	μA	
	Sleep Mode (One Channel On, Boost)	RUN3 = 5V and RUN1,2 = 0V, $V_{\text{FB3}} = 1.25\text{V}$		29	50	μA	
	Sleep Mode (Buck and Boost Channel On)	RUN1 = 5V and RUN2 = 0V or RUN2 = 5V and RUN1 = 0V, RUN3 = 5V, $V_{\text{FB1,2}} = 0.83\text{V}$ (No Load), $V_{\text{FB3}} = 1.25\text{V}$		34	55	μA	
	Sleep Mode (All Three Channels On)	RUN1,2,3 = 5V, $V_{\text{FB1,2}} = 0.83\text{V}$ (No Load), $V_{\text{FB3}} = 1.25\text{V}$		39	60	μA	
	Shutdown	RUN1,2,3 = 0V		3.6	10	μA	
UVLO	Undervoltage Lockout	DRV _{CC} Ramping Up DRVSET = 0V or $R_{\text{DRVSET}} \leq 100\text{k}\Omega$ DRVSET = INTV _{CC}	● ●	4.0 7.5	4.2 7.8	V V	
		DRV _{CC} Ramping Down DRVSET = 0V or $R_{\text{DRVSET}} \leq 100\text{k}\Omega$ DRVSET = INTV _{CC}	● ●	3.6 6.4	3.8 6.7	4.0 7.0	V V
$V_{\text{OVL1,2}}$	Buck Feedback Overvoltage Protection	Measured at $V_{\text{FB1,2}}$ Relative to Regulated $V_{\text{FB1,2}}$	7	10	13	%	
$I_{\text{SENSE1,2}^+}$	SENSE ⁺ Pin Current	Bucks (Channels 1 and 2)			± 1	μA	
I_{SENSE3^+}	SENSE ⁺ Pin Current	Boost (Channel 3)		170		μA	
$I_{\text{SENSE1,2}^-}$	SENSE ⁻ Pins Current	Bucks (Channels 1 and 2) $V_{\text{OUT1,2}} < V_{\text{INTVCC}} - 0.5\text{V}$ $V_{\text{OUT1,2}} > V_{\text{INTVCC}} + 0.5\text{V}$		700	± 1	μA μA	
		Boost (Channel 3) V_{SENSE^+} , $V_{\text{SENSE}^-} = 12\text{V}$			± 1	μA	
$DF_{\text{MAX(TG)}}$	Maximum Duty Factor for TG	Bucks (Channels 1,2) in Dropout, FREQ = 0V Boost (Channel 3) in Overvoltage	97.5	99 100		% %	
$DF_{\text{MAX(BG)}}$	Maximum Duty Factor for BG	Bucks (Channels 1,2) in Overvoltage Boost (Channel 3)		100 96		% %	
$I_{\text{TRACK/SS1,2}}$	Soft-Start Charge Current	$V_{\text{TRACK/SS1,2}} = 0\text{V}$	8	10	12	μA	
I_{SS}	Soft-Start Charge Current	$V_{\text{SS3}} = 0\text{V}$	8	10	12	μA	
$V_{\text{RUN1,2,3 ON}}$	RUN Pin On Threshold	V_{RUN1} , V_{RUN2} , V_{RUN3} Rising	●	1.22	1.275	1.33	V
$V_{\text{RUN1,2,3 Hyst}}$	RUN Pin Hysteresis			75		mV	
$V_{\text{SENSE(MAX)}}$	Maximum Current Sense Threshold	$V_{\text{FB1,2}} = 0.7\text{V}$, $V_{\text{SENSE1,2}^-} = 3.3\text{V}$, $V_{\text{FB3}} = 1.1\text{V}$, $V_{\text{SENSE3}^+} = 12\text{V}$	●	65	75	85	mV
$V_{\text{SENSE(CM)}}$	SENSE3 Pins Common Mode Range (BOOST Converter Input Supply Voltage)		2.2		60	V	
Gate Driver							
TG1,2,3	Pull-Up On-Resistance	$V_{\text{DRVSET}} = \text{INTV}_{\text{CC}}$		2.2		Ω	
	Pull-Down On-Resistance			1.0		Ω	
BG1,2,3	Pull-Up On-Resistance	$V_{\text{DRVSET}} = \text{INTV}_{\text{CC}}$		2.2		Ω	
	Pull-Down On-Resistance			1.0		Ω	

ELECTRICAL CHARACTERISTICS

The ● denotes the specifications which apply over the specified operating junction temperature range, otherwise specifications are at $T_A = 25^\circ\text{C}$. (Note 2) $V_{\text{BIAS}} = 12\text{V}$, $V_{\text{RUN}1,2,3} = 5\text{V}$, $V_{\text{EXTVCC}} = 0\text{V}$, $V_{\text{DRVSET}} = 0\text{V}$, $V_{\text{PRG3}} = \text{Float}$ unless otherwise noted.

SYMBOL	PARAMETER	CONDITIONS	MIN	TYP	MAX	UNITS
BDSW1,2,3	BOOST to DRV_{CC} Switch On-Resistance	$V_{\text{SW}} = 0\text{V}$, $V_{\text{DRVSET}} = \text{INTV}_{\text{CC}}$		3.7		Ω
TG1,2,3 t_r TG1,2,3 t_f	TG Transition Time: Rise Time Fall Time	(Note 6) $V_{\text{DRVSET}} = \text{INTV}_{\text{CC}}$ $C_{\text{LOAD}} = 3300\text{pF}$ $C_{\text{LOAD}} = 3300\text{pF}$		25 15		ns ns
BG1,2,3 t_r BG1,2,3 t_f	BG Transition Time: Rise Time Fall Time	(Note 6) $V_{\text{DRVSET}} = \text{INTV}_{\text{CC}}$ $C_{\text{LOAD}} = 3300\text{pF}$ $C_{\text{LOAD}} = 3300\text{pF}$		25 15		ns ns
TG1,2/BG1,2 t_{1D}	Top Gate Off to Bottom Gate On Delay Synchronous Switch-On Delay Time	$C_{\text{LOAD}} = 3300\text{pF}$ Each Driver, $V_{\text{DRVSET}} = \text{INTV}_{\text{CC}}$		55		ns
BG1,2/TG1,2 t_{1D}	Bottom Gate Off to Top Gate On Delay Top Switch-On Delay Time	$C_{\text{LOAD}} = 3300\text{pF}$ Each Driver, $V_{\text{DRVSET}} = \text{INTV}_{\text{CC}}$		50		ns
TG3/BG3 t_{1D}	CH3 Top Gate Off to Bottom Gate On Delay Bottom Switch-On Delay Time	$C_{\text{LOAD}} = 3300\text{pF}$ Each Driver, $V_{\text{DRVSET}} = \text{INTV}_{\text{CC}}$		85		ns
BG3/TG3 t_{1D}	CH3 Bottom Gate Off to Top Gate On Delay Synchronous Switch-On Delay Time	$C_{\text{LOAD}} = 3300\text{pF}$ Each Driver, $V_{\text{DRVSET}} = \text{INTV}_{\text{CC}}$		80		ns
$t_{\text{ON(MIN)1,2}}$	Buck Minimum On-Time	(Note 7) $V_{\text{DRVSET}} = \text{INTV}_{\text{CC}}$		80		ns
$t_{\text{ON(MIN)3}}$	Boost Minimum On-Time	(Note 7) $V_{\text{DRVSET}} = \text{INTV}_{\text{CC}}$		120		ns

DRV_{CC} Linear Regulator

$V_{\text{DRVCC(INT)}}$	DRV _{CC} Voltage from Internal V_{BIAS} LDO	$V_{\text{EXTVCC}} = 0\text{V}$ $7\text{V} < V_{\text{BIAS}} < 60\text{V}$, $\text{DRVSET} = 0\text{V}$ $11\text{V} < V_{\text{BIAS}} < 60\text{V}$, $\text{DRVSET} = \text{INTV}_{\text{CC}}$	5.8 9.6	6.0 10.0	6.2 10.4	V V
$V_{\text{LDOREG(INT)}}$	DRV _{CC} Load Regulation from V_{BIAS} LDO	$I_{\text{CC}} = 0\text{mA}$ to 50mA , $V_{\text{EXTVCC}} = 0\text{V}$		0.9	2.0	%
$V_{\text{DRVCC(EXT)}}$	DRV _{CC} Voltage from Internal EXTV_{CC} LDO	$7\text{V} < V_{\text{EXTVCC}} < 13\text{V}$, $\text{DRVSET} = 0\text{V}$ $11\text{V} < V_{\text{EXTVCC}} < 13\text{V}$, $\text{DRVSET} = \text{INTV}_{\text{CC}}$	5.8 9.6	6.0 10.0	6.2 10.4	V V
$V_{\text{LDOREG(EXT)}}$	DRV _{CC} Load Regulation from Internal EXTV_{CC} LDO	$I_{\text{CC}} = 0\text{mA}$ to 50mA , $V_{\text{EXTVCC}} = 8.5\text{V}$, $V_{\text{DRVSET}} = 0\text{V}$		0.7	2.0	%
V_{EXTVCC}	EXTV_{CC} LDO Switchover Voltage	EXTV_{CC} Ramping Positive $\text{DRVSET} = 0\text{V}$ or $R_{\text{DRVSET}} \leq 100\text{k}\Omega$ $\text{DRVSET} = \text{INTV}_{\text{CC}}$	4.5 7.4	4.7 7.7	4.9 8.0	V V
V_{LDOHYS}	EXTV_{CC} Hysteresis			250		mV
$V_{\text{DRVCC}(50\text{k}\Omega)}$	Programmable DRV _{CC}	$R_{\text{DRVSET}} = 50\text{k}\Omega$, $V_{\text{EXTVCC}} = 0\text{V}$		5.0		V
$V_{\text{DRVCC}(70\text{k}\Omega)}$	Programmable DRV _{CC}	$R_{\text{DRVSET}} = 70\text{k}\Omega$, $V_{\text{EXTVCC}} = 0\text{V}$	6.4	7.0	7.6	V
$V_{\text{DRVCC}(90\text{k}\Omega)}$	Programmable DRV _{CC}	$R_{\text{DRVSET}} = 90\text{k}\Omega$, $V_{\text{EXTVCC}} = 0\text{V}$		9.0		V

Oscillator and Phase-Locked Loop

$f_{25\text{k}\Omega}$	Programmable Frequency	$R_{\text{FREQ}} = 25\text{k}\Omega$, $\text{PLLIN/MODE} = \text{DC Voltage}$		105		kHz
$f_{65\text{k}\Omega}$	Programmable Frequency	$R_{\text{FREQ}} = 65\text{k}\Omega$, $\text{PLLIN/MODE} = \text{DC Voltage}$	375	440	505	kHz
$f_{105\text{k}\Omega}$	Programmable Frequency	$R_{\text{FREQ}} = 105\text{k}\Omega$, $\text{PLLIN/MODE} = \text{DC Voltage}$		835		kHz
f_{LOW}	Low Fixed Frequency	$V_{\text{FREQ}} = 0\text{V}$, $\text{PLLIN/MODE} = \text{DC Voltage}$	320	350	380	kHz
f_{HIGH}	High Fixed Frequency	$V_{\text{FREQ}} = \text{INTV}_{\text{CC}}$, $\text{PLLIN/MODE} = \text{DC Voltage}$	485	535	585	kHz
f_{SYNC}	Synchronizable Frequency	$\text{PLLIN/MODE} = \text{External Clock}$	● 75		850	kHz
PLLIN V_{IH}	PLLIN/MODE Input High Level	$\text{PLLIN/MODE} = \text{External Clock}$	● 2.5			V
PLLIN V_{IL}	PLLIN/MODE Input Low Level	$\text{PLLIN/MODE} = \text{External Clock}$	●		0.5	V

BOOST3 Charge Pump

I_{BST3}	BOOST3 Charge Pump Available Output Current	$\text{FREQ} = 0\text{V}$, $\text{PLLIN/MODE} = \text{INTV}_{\text{CC}}$ $V_{\text{BOOST3}} = 16.5\text{V}$, $V_{\text{SW3}} = 12\text{V}$ $V_{\text{BOOST3}} = 19\text{V}$, $V_{\text{SW3}} = 12\text{V}$		75 35		μA μA
-------------------	---	---	--	----------	--	--------------------------------

ELECTRICAL CHARACTERISTICS

Note 1: Stresses beyond those listed under Absolute Maximum Ratings may cause permanent damage to the device. Exposure to any Absolute Maximum Ratings for extended periods may affect device reliability and lifetime.

Note 2: The LTC3899 is tested under pulsed load conditions such that $T_J \approx T_A$. The LTC3899E is guaranteed to meet performance specifications from 0°C to 85°C. Specifications over the –40°C to 125°C operating junction temperature range are assured by design, characterization and correlation with statistical process controls. The LTC3899I is guaranteed over the –40°C to 125°C operating junction temperature range, the LTC3899H is guaranteed over the –40°C to 150°C operating junction temperature range, and the LTC3899MP is tested and guaranteed over the –55°C to 150°C operating junction temperature range. High junction temperatures degrade operating lifetimes; operating lifetime is derated for junction temperatures greater than 125°C. Note that the maximum ambient temperature consistent with these specifications is determined by specific operating conditions in conjunction with board layout, the rated package thermal impedance and other environmental factors. The junction temperature (T_J , in °C) is calculated from the ambient temperature (T_A , in °C) and power dissipation (P_D , in Watts) according to the formula:

$$T_J = T_A + (P_D \cdot \theta_{JA})$$

where $\theta_{JA} = 34^\circ\text{C/W}$ for the QFN package and where $\theta_{JA} = 25^\circ\text{C/W}$ for the TSSOP package.

Note 3: This IC includes overtemperature protection that is intended to protect the device during momentary overload conditions. The maximum rated junction temperature will be exceeded when this protection is active. Continuous operation above the specified absolute maximum operating junction temperature may impair device reliability or permanently damage the device.

Note 4: The LTC3899 is tested in a feedback loop that servos $V_{I_{TH1,2,3}}$ to a specified voltage and measures the resultant $V_{FB1,2,3}$. The specification at 85°C is not tested in production and is assured by design, characterization and correlation to production testing at other temperatures (125°C for the LTC3899E and LTC3899I, 150°C for the LTC3899H and LTC3899MP). For the LTC3899I and LTC3899H, the specification at 0°C is not tested in production and is assured by design, characterization and correlation to production testing at –40°C. For the LTC3899MP, the specification at 0°C is not tested in production and is assured by design, characterization and correlation to production testing at –55°C.

Note 5: Dynamic supply current is higher due to the gate charge being delivered at the switching frequency. See Applications information.

Note 6: Rise and fall times are measured using 10% and 90% levels. Delay times are measured using 50% levels

Note 7: The minimum on-time condition is specified for an inductor peak-to-peak ripple current >40% of I_{MAX} (See Minimum On-Time Considerations in the Applications Information section).

Note 8: Do not apply a voltage or current source to these pins. They must be connected to capacitive loads only, otherwise permanent damage may occur.

TYPICAL PERFORMANCE CHARACTERISTICS

Efficiency and Power Loss vs Output Current (Buck)

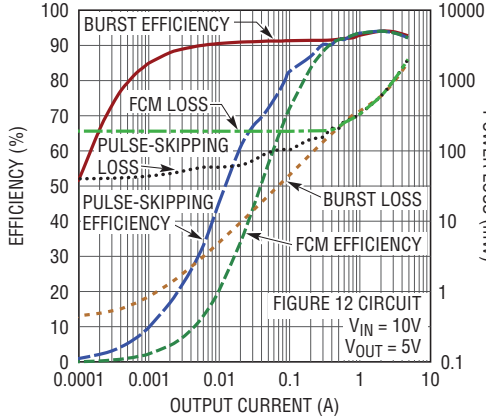

3899 G01

Efficiency vs Output Current (Buck)

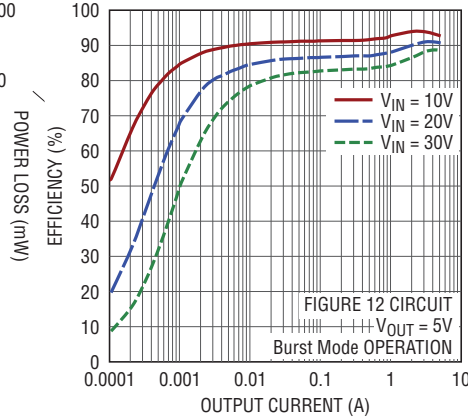

3899 G02

Efficiency vs Input Voltage (Buck)

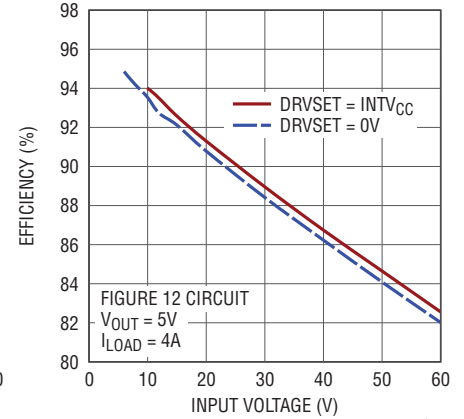

3899 G03

Load Step (Buck) Burst Mode Operation

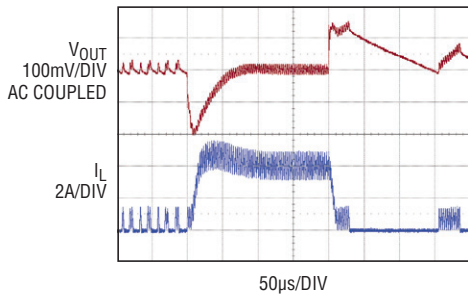

3899 G04

Load Step (Buck) Pulse-Skipping Mode

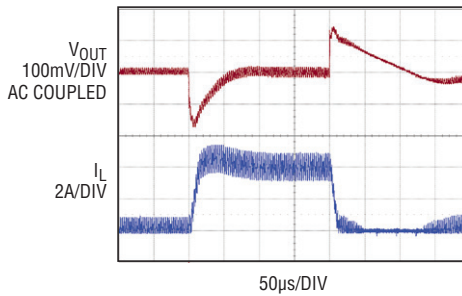

3899 G05

Load Step (Buck) Forced Continuous Mode

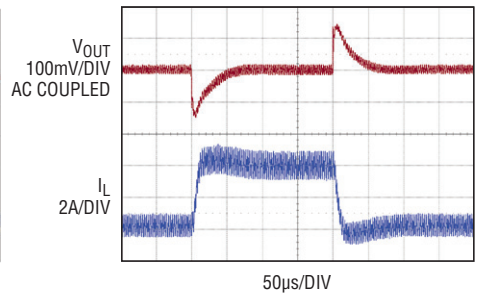

3899 G06

Inductor Current at Light Load (Buck)

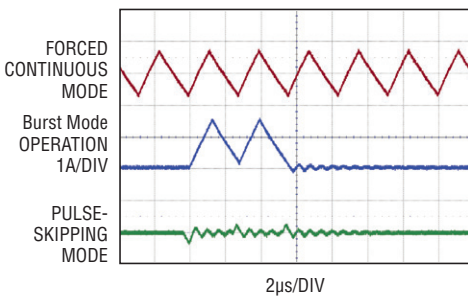

3899 G07

Soft Start-Up (Buck)

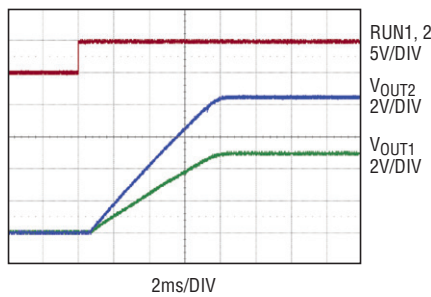

3899 G08

Buck Regulated Feedback Voltage vs Temperature

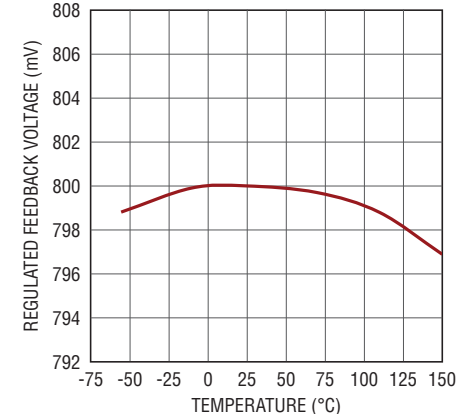

3899 G09

TYPICAL PERFORMANCE CHARACTERISTICS

Efficiency and Power Loss vs Output Current (Boost)

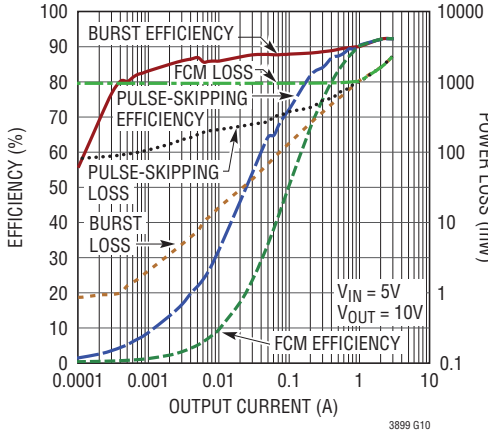

Efficiency vs Input Voltage (Boost)

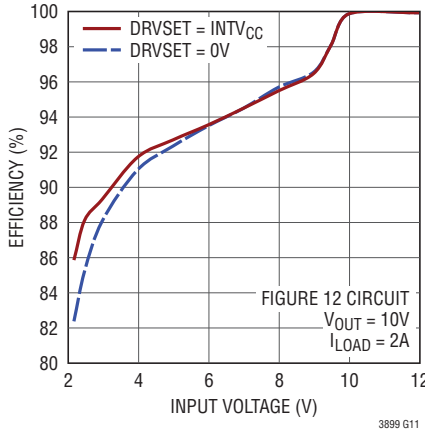

Shutdown (RUN) Threshold vs Temperature

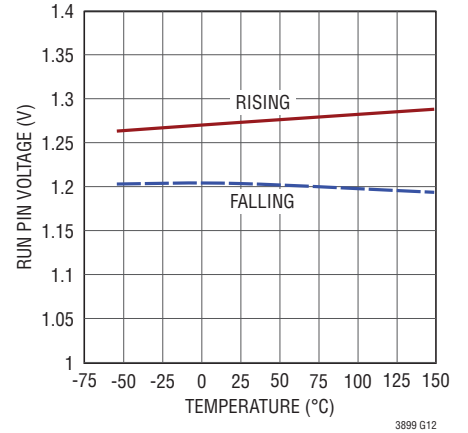

Load Step (Boost) Forced Continuous Mode

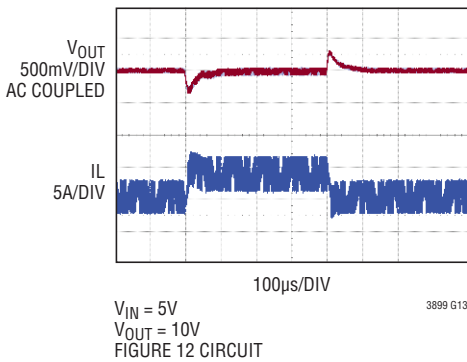

Load Step (Boost) Pulse-Skipping Mode

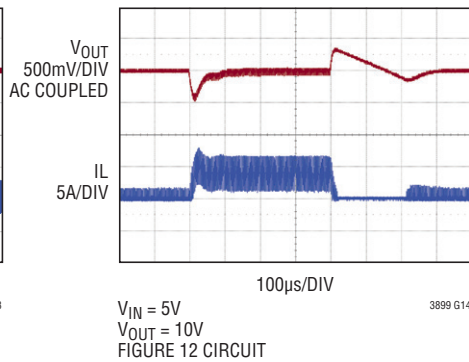

Load Step (Boost) Burst Mode Operation

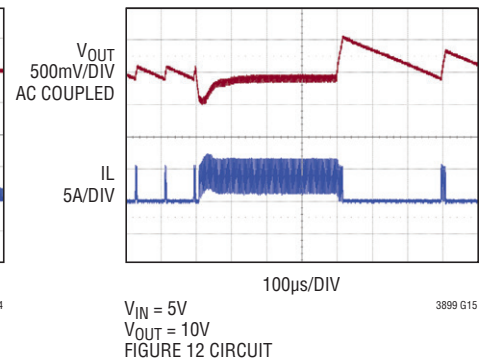

Inductor Current at Light Load (Boost)

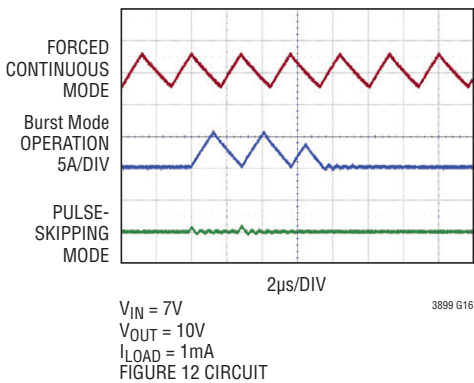

Soft Start-Up (Boost)

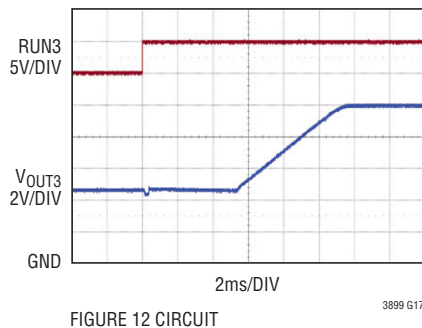

Boost Regulated Feedback Voltage vs Temperature

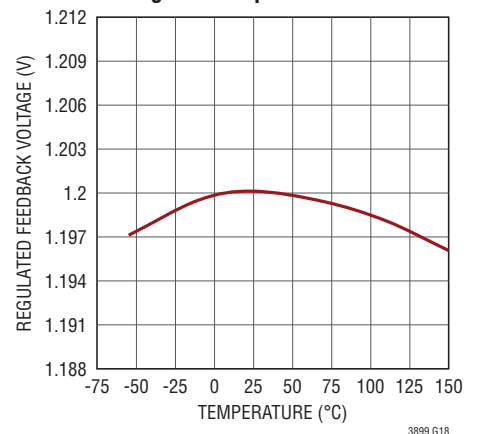

TYPICAL PERFORMANCE CHARACTERISTICS

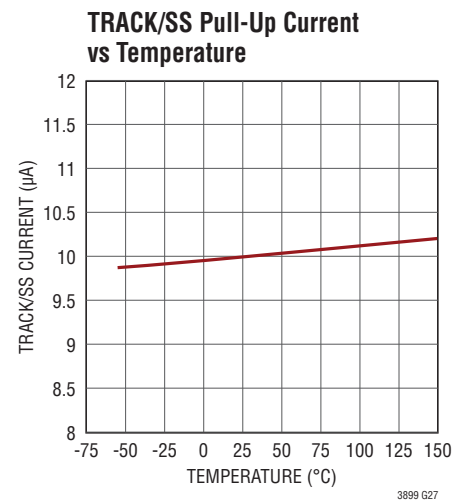
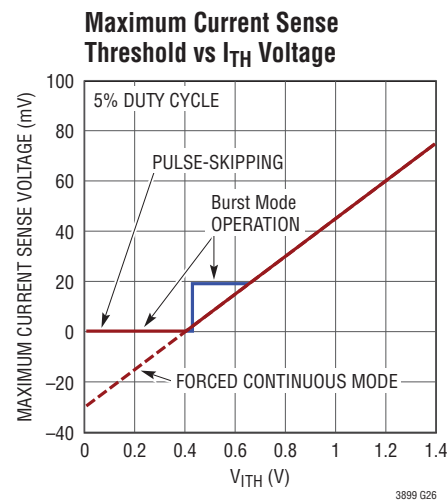
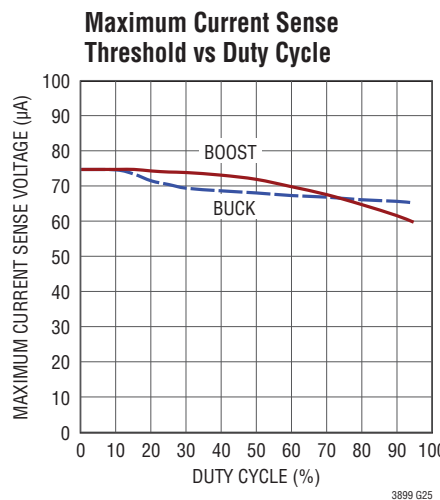
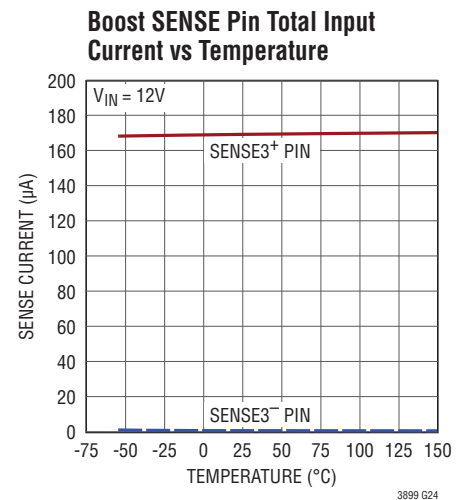
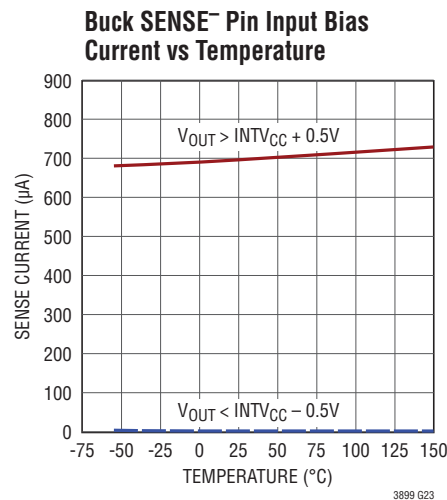
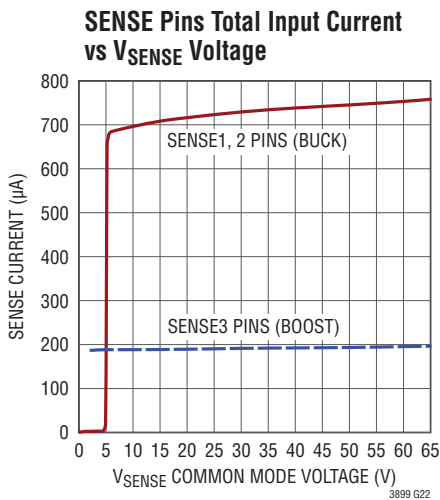
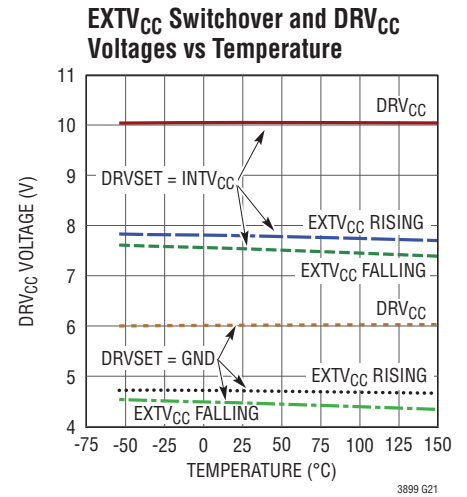
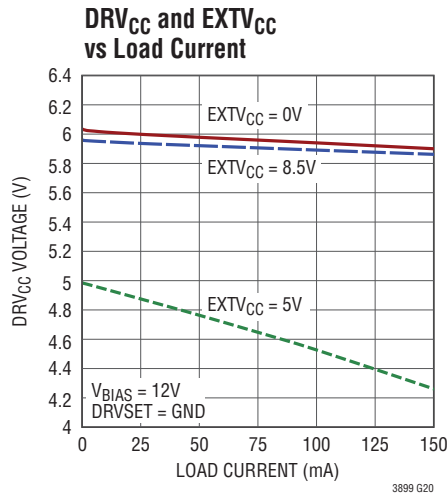
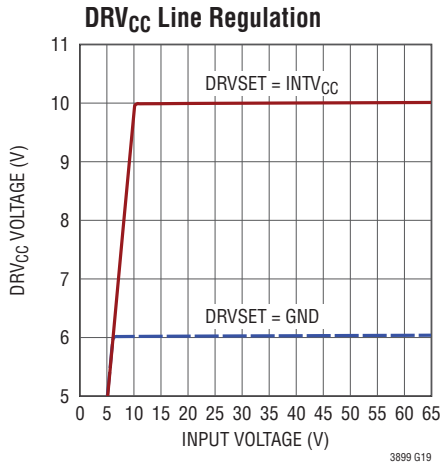

TYPICAL PERFORMANCE CHARACTERISTICS

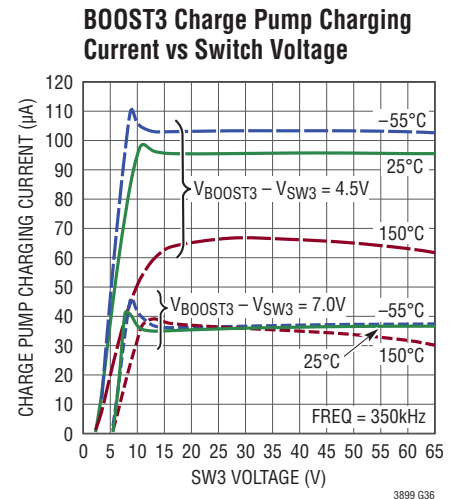
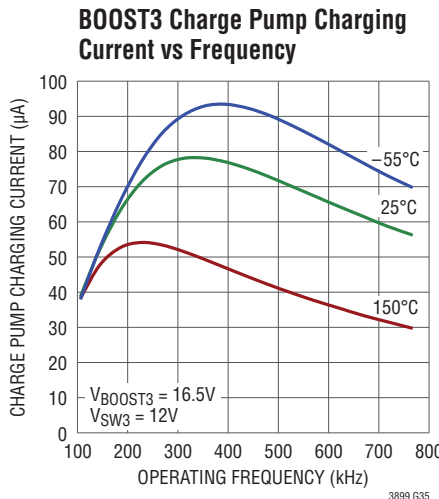
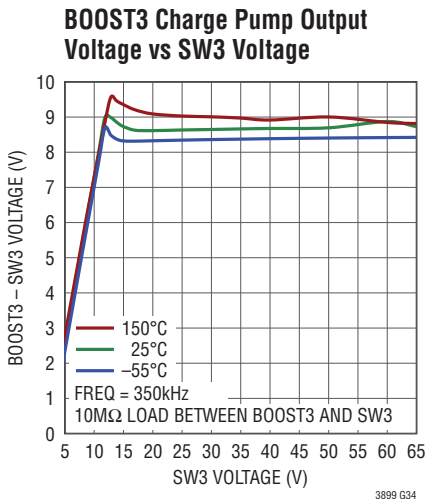
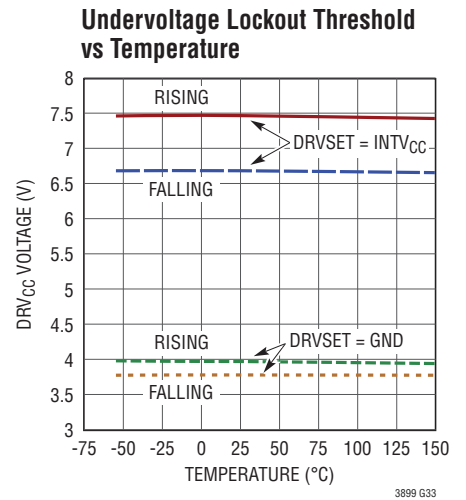
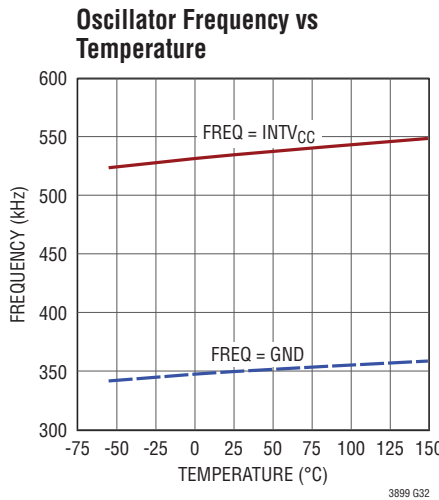
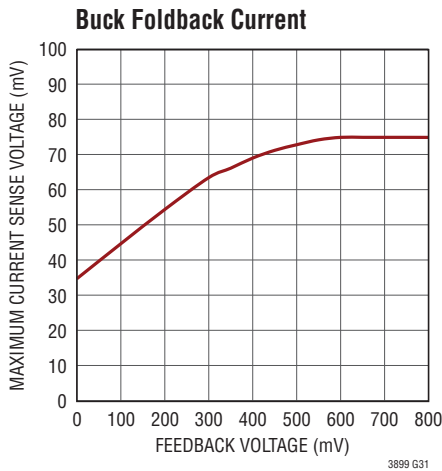
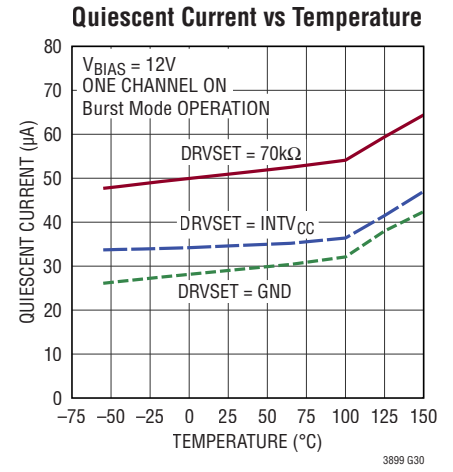
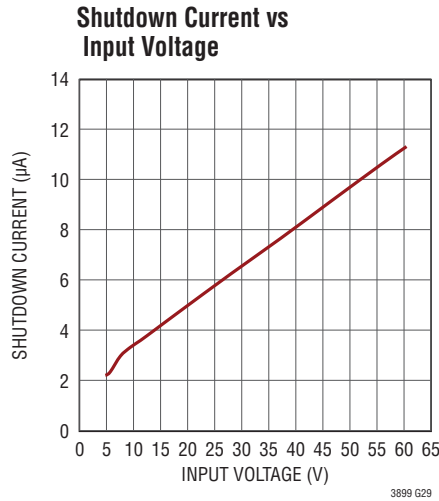
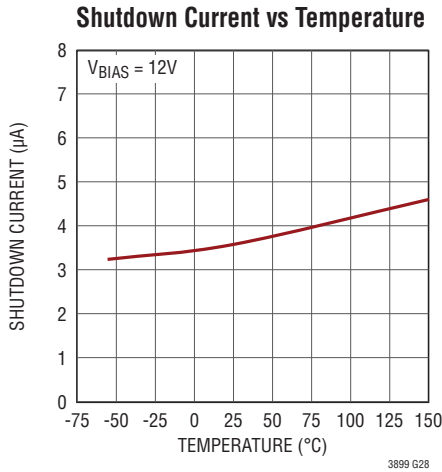

PIN FUNCTIONS (QFN/TSSOP)

FREQ (Pin 1/ Pin 5): The frequency control pin for the internal VCO. Connecting this pin to GND forces the VCO to a fixed low frequency of 350kHz. Connecting this pin to INTV_{CC} forces the VCO to a fixed high frequency of 535kHz. Other frequencies between 50kHz and 900kHz can be programmed using a resistor between FREQ and GND. The resistor and an internal 20 μ A source current create a voltage used by the internal oscillator to set the frequency.

PLLIN/MODE (Pin 2/Pin 6): External Synchronization Input to Phase Detector and Forced Continuous Mode Input. When an external clock is applied to this pin, the phase-locked loop will force the rising TG1 signal to be synchronized with the rising edge of the external clock, and the regulators will operate in forced continuous mode. When not synchronizing to an external clock, this input, which acts on all three controllers, determines how the LTC3899 operates at light loads. Pulling this pin to ground selects Burst Mode operation. An internal 100k resistor to ground also invokes Burst Mode operation when the pin is floated. Tying this pin to INTV_{CC} forces continuous inductor current operation. Tying this pin to a voltage greater than 1.1V and less than INTV_{CC} – 1.3V selects pulse-skipping operation. This can be done by connecting a 100k resistor from this pin to INTV_{CC}.

INTV_{CC} (Pin 8/Pin 12): Output of the Internal 5V Low Dropout Regulator. The low voltage analog and digital circuits are powered from this voltage source. A low ESR 0.1 μ F ceramic bypass capacitor should be connected between INTV_{CC} and GND, as close as possible to the IC. INTV_{CC} should not be used to power or bias any external circuitry other than to configure FREQ, PLLIN/MODE, DRVSET AND VPRG3 pins.

RUN1, RUN2, RUN3 (Pins 9, 10, 11/ Pins 13, 14, 15): Run Control Inputs for Each Controller. Forcing any of these pins below 1.2V shuts down that controller. Forcing all of these pins below 0.7V shuts down the entire LTC3899, reducing quiescent current to approximately 3.6 μ A.

DRVSET (Pin 16/Pin 20): Sets the regulated output voltage of the DRV_{CC} LDO regulator. Connecting this pin to GND sets DRV_{CC} to 6V whereas connecting it to INTV_{CC} sets DRV_{CC} to 10V. Voltages between 5V and 10V can be programmed by placing a resistor (50k to 100k) between

the DRVSET pin and GND. The DRVSET pin also determines the higher or lower DRV_{CC} UVLO and EXTV_{CC} switchover thresholds, as listed on the Electrical Characteristics table. Connecting DRVSET to GND or programming DRVSET with a resistor chooses the lower thresholds whereas tying DRVSET to INTV_{CC} chooses the higher thresholds. When programming DRVSET with a resistor, do not choose a resistor value less than 50k (unless shorting DRVSET to GND) or higher than 100k.

DRV_{CC} (Pin 22/Pin 26): Output of the Internal or External Low Dropout (LDO) Regulator. The gate drivers are powered from this voltage source. The DRV_{CC} voltage is set by the DRVSET pin. Must be decoupled to ground with a minimum of 4.7 μ F ceramic or other low ESR capacitor. Do not use the DRV_{CC} pin for any other purpose.

EXTV_{CC} (Pin 23/Pin 27): External Power Input to an Internal LDO Connected to DRV_{CC}. This LDO supplies DRV_{CC} power, bypassing the internal LDO powered from V_{BIAS} whenever EXTV_{CC} is higher than its switchover threshold (4.7V or 7.7V depending on the DRVSET pin). See EXTV_{CC} Connection in the Applications Information section. Do not float or exceed 14V on this pin. Do not connect EXTV_{CC} to a voltage greater than V_{BIAS}. Connect to GND if not used.

V_{BIAS} (Pin 24/Pin 28): Main Supply Pin. A bypass capacitor should be tied between this pin and the GND pin.

BG1, BG2, BG3 (Pins 29, 21, 25/Pins 33, 25, 29): High Current Gate Drives for Bottom N-Channel MOSFETs. Voltage swing at these pins is from ground to DRV_{CC}.

BOOST1, BOOST2, BOOST3 (Pins 30, 20, 26/Pins 34, 24, 30): Bootstrapped Supplies to the Topside Floating Drivers. Capacitors are connected between the BOOST and SW pins. Voltage swing at BOOST1 and BOOST2 pins is from approximately DRV_{CC} to (V_{IN1,2} + DRV_{CC}). Voltage swing at BOOST3 is from DRV_{CC} to (V_{OUT3} + DRV_{CC}).

SW1, SW2, SW3 (Pins 31, 19, 28/Pins 35, 23, 32): Switch Node Connections to Inductors.

TG1, TG2, TG3 (Pins 32, 18, 27/Pins 36, 22, 31): High Current Gate Drives for Top N-Channel MOSFETs. These are the outputs of floating drivers with a voltage swing equal to DRV_{CC} superimposed on the switch node voltage SW.

PIN FUNCTIONS (QFN/TSSOP)

TRACK/SS1, TRACK/SS2, SS3 (Pins 33, 17, 3/Pins 37, 21, 7): External Tracking and Soft-Start Input. For the buck channels, the LTC3899 regulates the $V_{FB1,2}$ voltage to the smaller of 0.8V, or the voltage on the TRACK/SS1,2 pin. For the boost channel, the LTC3899 regulates the V_{FB3} voltage to the smaller of 1.2V, or the voltage on the SS3 pin. An internal 10 μ A pull-up current source is connected to this pin. A capacitor to ground at this pin sets the ramp time to final regulated output voltage. Alternatively, a resistor divider on another voltage supply connected to the TRACK/SS pins of the buck channels allow the LTC3899 buck outputs to track the other supply during start-up.

VPRG3 (Pin 34/Pin 38): Channel 3 Output Control Pin. This pin sets the boost channel to adjustable output mode using external feedback resistors or fixed 10V/12V output mode. Floating this pin allows the output to be programmed through the V_{FB3} pin using external resistors, regulating V_{FB3} to the 1.2V reference. Connecting this pin to GND or INTV_{CC} programs the output to 10V or 12V (respectively), and V_{FB3} is used to sense the output voltage.

ITH1, ITH2, ITH3 (Pins 35, 15, 7/Pins 1, 19, 11): Error Amplifier Outputs and Switching Regulator Compensation Points. Each associated channel's current comparator trip point increases with this control voltage.

V_{FB1}, V_{FB2} (Pins 36, 14/Pins 2, 18): These pins receive the remotely sensed feedback voltage for each buck controller from an external resistive divider across the output.

V_{FB3} (Pins 6/Pins 10): If VPRG3 is floating, this pin receives the remotely sensed feedback voltage for the boost controller from an external resistive divider across the output. If VPRG3 is tied to GND or INTV_{CC}, this pin receives the remotely sensed output voltage of the boost controller.

SENSE1⁺, SENSE2⁺, SENSE3⁺ (Pins 37, 13, 4/Pins 3, 17, 8): The (+) Input to the Differential Current Comparators. The ITH pin voltage and controlled offsets between the SENSE⁻ and SENSE⁺ pins in conjunction with R_{SENSE} set the current trip threshold. For the boost channel, the SENSE3⁺ pin supplies current to the current comparator.

SENSE1⁻, SENSE2⁻, SENSE3⁻ (Pins 38, 12, 5/Pins 4, 16, 9): The (-) Input to the Differential Current Comparators. When SENSE1,2⁻ for the buck channels is greater than INTV_{CC}, then SENSE1,2⁻ pin supplies current to the current comparator.

GND (Exposed Pad Pin 39/Exposed Pad Pin 39): Ground. The exposed pad must be soldered to the PCB for rated electrical and thermal performance.

OPERATION (Refer to the Functional Diagrams)

After the top MOSFET for the bucks (the bottom MOSFET for the boost) is turned off each cycle, the bottom MOSFET is turned on (the top MOSFET for the boost) until either the inductor current starts to reverse, as indicated by the current comparator I_R , or the beginning of the next clock cycle.

DRV_{CC}/EXTV_{CC}/INTV_{CC} Power

Power for the top and bottom MOSFET drivers is derived from the DRV_{CC} pin. The DRV_{CC} supply voltage can be programmed from 5V to 10V through control of the DRVSET pin. When the EXTV_{CC} pin is tied to a voltage below its switchover voltage (4.7V or 7.7V depending on the DRVSET voltage), the V_{BIAS} LDO (low dropout linear regulator) supplies power from V_{BIAS} to DRV_{CC}. If EXTV_{CC} is taken above its switchover voltage, the V_{BIAS} LDO is turned off and an EXTV_{CC} LDO is turned on. Once enabled, the EXTV_{CC} LDO supplies power from EXTV_{CC} to DRV_{CC}. Using the EXTV_{CC} pin allows the DRV_{CC} power to be derived from a high efficiency external source such as one of the LTC3899 buck regulator outputs.

Each top MOSFET driver is biased from the floating bootstrap capacitor, C_B, which normally recharges during each cycle through an internal switch whenever SW goes low.

For buck channels 1 and 2, if the input voltage decreases to a voltage close to its output, the loop may enter dropout and attempt to turn on the top MOSFET continuously. The dropout detector detects this and forces the top MOSFET off for about one-twelfth of the clock period every tenth cycle to allow C_B to recharge, resulting in about 99% duty cycle.

The INTV_{CC} supply powers most of the other internal circuits in the LTC3899. The INTV_{CC} LDO regulates to a fixed value of 5V and its power is derived from the DRV_{CC} supply.

Shutdown and Start-Up (RUN, TRACK/SS Pins)

The three channels of the LTC3899 can be independently shut down using the RUN1, RUN2 and RUN3 pins. Pulling a RUN pin below 1.20V shuts down the main control loop for that channel. Pulling all three pins below 0.7V disables all controllers and most internal circuits, including the DRV_{CC} and INTV_{CC} LDOs. In this state, the LTC3899 draws only 3.6μA of quiescent current.

Releasing a RUN pin allows a small 150nA internal current to pull up the pin to enable that controller. Each RUN pin may be externally pulled up or driven directly by logic. Each RUN pin can tolerate up to 65V (absolute maximum), so it can be conveniently tied to V_{BIAS} in always-on applications where one or more controllers are enabled continuously and never shut down.

The start-up of each controller's output voltage V_{OUT} is controlled by the voltage on the TRACK/SS pin (TRACK/SS1 for channel 1, TRACK/SS2 for channel 2, SS3 for channel 3). When the voltage on the TRACK/SS pin is less than the 0.8V internal reference for the bucks and the 1.2V internal reference for the boost, the LTC3899 regulates the V_{FB} voltage to the TRACK/SS pin voltage instead of the corresponding reference voltage. This allows the TRACK/SS pin to be used to program a soft-start by connecting an external capacitor from the TRACK/SS pin to GND. An internal 10μA pull-up current charges this capacitor creating a voltage ramp on the TRACK/SS pin. As the TRACK/SS voltage rises linearly from 0V to 0.8V/1.2V (and beyond up to about 4V), the output voltage V_{OUT} rises smoothly from zero (V_{IN} for the boost) to its final value.

Alternatively the TRACK/SS pins for buck channels 1 and 2 can be used to cause the start-up of V_{OUT} to track that of another supply. Typically, this requires connecting to the TRACK/SS pin an external resistor divider from the other supply to ground (see Applications Information section).

Light Load Current Operation (Burst Mode Operation, Pulse-Skipping or Forced Continuous Mode) (PLLIN/MODE Pin)

The LTC3899 can be enabled to enter high efficiency Burst Mode operation, constant frequency pulse-skipping mode, or forced continuous conduction mode at low load currents. To select Burst Mode operation, tie the PLLIN/MODE pin to GND. To select forced continuous operation, tie the PLLIN/MODE pin to INTV_{CC}. To select pulse-skipping mode, tie the PLLIN/MODE pin to a DC voltage greater than 1.1V and less than INTV_{CC} – 1.3V. This can be done by connecting a 100kΩ resistor between PLLIN/MODE and INTV_{CC}.

When a controller is enabled for Burst Mode operation, the minimum peak current in the inductor is set to approximately 25% of the maximum sense voltage (30%

3899fa

OPERATION (Refer to the Functional Diagrams)

for the boost) even though the voltage on the ITH pin indicates a lower value. If the average inductor current is higher than the load current, the error amplifier, EA, will decrease the voltage on the ITH pin. When the ITH voltage drops below 0.425V, the internal sleep signal goes high (enabling sleep mode) and both external MOSFETs are turned off. The ITH pin is then disconnected from the output of the EA and parked at 0.450V.

In sleep mode, much of the internal circuitry is turned off, reducing the quiescent current that the LTC3899 draws. If one channel is in sleep mode and the other two are shut down, the LTC3899 draws only 29 μ A of quiescent current (with DRVSET = 0V). If two channels are in sleep mode and the other shut down, it draws only 34 μ A of quiescent current. If all three controllers are enabled in sleep mode, the LTC3899 draws only 39 μ A of quiescent current. In sleep mode, the load current is supplied by the output capacitor. As the output voltage decreases, the EA's output begins to rise. When the output voltage drops enough, the ITH pin is reconnected to the output of the EA, the sleep signal goes low, and the controller resumes normal operation by turning on the top external MOSFET (the bottom external MOSFET for the boost) on the next cycle of the internal oscillator.

When a controller is enabled for Burst Mode operation, the inductor current is not allowed to reverse. The reverse current comparator (I_R) turns off the bottom external MOSFET (the top external MOSFET for the boost) just before the inductor current reaches zero, preventing it from reversing and going negative. Thus, the controller operates discontinuously.

In forced continuous operation, the inductor current is allowed to reverse at light loads or under large transient conditions. The peak inductor current is determined by the voltage on the ITH pin, just as in normal operation. In this mode, the efficiency at light loads is lower than in Burst Mode operation. However, continuous operation has the advantage of lower output voltage ripple and less interference to audio circuitry. In forced continuous mode, the output ripple is independent of load current. Clocking the LTC3899 from an external source enables forced continuous mode (see the Frequency Selection and Phase-Locked Loop section).

When the PLLIN/MODE pin is connected for pulse-skipping mode, the LTC3899 operates in PWM pulse-skipping mode at light loads. In this mode, constant frequency operation is maintained down to approximately 1% of designed maximum output current. At very light loads, the current comparator, I_{CMP} , may remain tripped for several cycles and force the external top MOSFET (bottom for the boost) to stay off for the same number of cycles (i.e., skipping pulses). The inductor current is not allowed to reverse (discontinuous operation). This mode, like forced continuous operation, exhibits low output ripple as well as low audio noise and reduced RF interference as compared to Burst Mode operation. It provides higher low current efficiency than forced continuous mode, but not nearly as high as Burst Mode operation.

Frequency Selection and Phase-Locked Loop (FREQ and PLLIN/MODE Pins)

The selection of switching frequency is a trade-off between efficiency and component size. Low frequency operation increases efficiency by reducing MOSFET switching losses, but requires larger inductance and/or capacitance to maintain low output ripple voltage.

The switching frequency of the LTC3899's controllers can be selected using the FREQ pin.

If the PLLIN/MODE pin is not being driven by an external clock source, the FREQ pin can be tied to GND, tied to INTV_{CC} or programmed through an external resistor. Tying FREQ to GND selects 350kHz while tying FREQ to INTV_{CC} selects 535kHz. Placing a resistor between FREQ and GND allows the frequency to be programmed between 50kHz and 900kHz, as shown in Figure 10.

A phase-locked loop (PLL) is available on the LTC3899 to synchronize the internal oscillator to an external clock source that is connected to the PLLIN/MODE pin. The LTC3899's phase detector adjusts the voltage (through an internal lowpass filter) of the VCO input to align the turn-on of controller 1's external top MOSFET (and controller 3's external bottom MOSFET) to the rising edge of the synchronizing signal. Thus, the turn-on of controller 2's external top MOSFET is 180° out of phase to the rising edge of the external clock source.

OPERATION (Refer to the Functional Diagrams)

The VCO input voltage is prebiased to the operating frequency set by the FREQ pin before the external clock is applied. If prebiased near the external clock frequency, the PLL loop only needs to make slight changes to the VCO input in order to synchronize the rising edge of the external clock's to the rising edge of TG1. The ability to prebias the loop filter allows the PLL to lock-in rapidly without deviating far from the desired frequency.

The typical capture range of the LTC3899's phase-locked loop is from approximately 55kHz to 1MHz, with a guarantee to be between 75kHz and 850kHz. In other words, the LTC3899's PLL is guaranteed to lock to an external clock source whose frequency is between 75kHz and 850kHz.

The typical input clock thresholds on the PLLIN/MODE pin are 1.6V (rising) and 1.1V (falling). It is recommended that the external clock source swings from ground (0V) to at least 2.5V.

Boost Controller Operation When $V_{IN} > V_{OUT}$

When the input voltage to the boost channel rises above its regulated V_{OUT} voltage, the controller can behave differently depending on the mode, inductor current and V_{IN} voltage. In forced continuous mode, the loop works to keep the top MOSFET on continuously once V_{IN} rises above V_{OUT} . An internal charge pump delivers current to the boost capacitor from the BOOST3 pin to maintain a sufficiently high TG voltage. Because the LTC3899 uses internal switches and does not require external bootstrap diodes, the charge pump only has to overcome small leakage currents (board leakage, etc.).

In pulse-skipping mode, if V_{IN} is between 0% and 10% above the regulated V_{OUT} voltage, TG3 turns on if the inductor current rises above approximately 3% of the programmed I_{LIM} current. If the part is programmed in Burst Mode operation under this same V_{IN} window, then TG3 turns on at the same threshold current as long as the chip is awake (one of the buck channels is awake and switching). If both buck channels are asleep or shut down in this V_{IN} window, then TG3 will remain off regardless of the inductor current.

If V_{IN} rises more than 10% above the regulated V_{OUT} voltage in any mode, the controller turns on TG3 regardless of the

inductor current. In Burst Mode operation, however, the internal charge pump turns off if the entire chip is asleep (if the two buck channels are also asleep or shut down). With the charge pump off, there would be nothing to prevent the boost capacitor from discharging, resulting in an insufficient TG voltage needed to keep the top MOSFET completely on. The charge pump turns back on when the chip wakes up, and it remains on as long as one of the buck channels is actively switching.

Boost Controller at Low SENSE Pin Common Voltage

The current comparator of the boost controller is powered directly from the SENSE3+ pin and can operate to voltages as low as 2.2V. Since this is lower than the V_{BIAS} UVLO of the chip, V_{BIAS} can be connected to the output of the boost controller, as illustrated in the typical application circuit in Figure 12. This allows the boost controller to handle input voltage transients down to 2.2V while maintaining output voltage regulation. If SENSE3+ falls below 2.0V, then switching stops and SS3 is pulled low. If SENSE3+ rises back above 2.2V, the SS3 pin will be released, initiating a new soft-start sequence.

Buck Controller Output Overvoltage Protection

The two buck channels have an overvoltage comparator that guards against transient overshoots as well as other more serious conditions that may overvoltage the output. When the $V_{FB1,2}$ pin rises by more than 10% above its regulation point of 0.800V, the top MOSFET is turned off and the bottom MOSFET is turned on until the overvoltage condition is cleared.

Buck Foldback Current

When the buck output voltage falls to less than 70% of its nominal level, foldback current limiting is activated, progressively lowering the peak current limit in proportion to the severity of the overcurrent or short-circuit condition. Foldback current limiting is disabled during the soft-start interval (as long as the $V_{FB1,2}$ voltage is keeping up with the TRACK/SS1,2 voltage). There is no foldback current limiting for the boost channel.

APPLICATIONS INFORMATION

The Typical Application on the first page is a basic LTC3899 application circuit. LTC3899 can be configured to use either DCR (inductor resistance) sensing or low value resistor sensing. The choice between the two current sensing schemes is largely a design trade-off between cost, power consumption and accuracy. DCR sensing is becoming popular because it saves expensive current sensing resistors and is more power efficient, especially in high current applications. However, current sensing resistors provide the most accurate current limits for the controller. Other external component selection is driven by the load requirement, and begins with the selection of R_{SENSE} (if R_{SENSE} is used) and inductor value. Next, the power MOSFETs and Schottky diodes are selected. Finally, input and output capacitors are selected.

SENSE⁺ and SENSE⁻ Pins

The SENSE⁺ and SENSE⁻ pins are the inputs to the current comparators.

Buck Controllers (SENSE1⁺/SENSE1⁻, SENSE2⁺/SENSE2⁻): The common mode voltage range on these pins is 0V to 65V (absolute maximum), enabling the LTC3899 to regulate buck output voltages up to a nominal 60V (allowing margin for tolerances and transients). The SENSE⁺ pin is high impedance over the full common mode range, drawing at most $\pm 1\mu\text{A}$. This high impedance allows the current comparators to be used in inductor DCR sensing. The impedance of the SENSE⁻ pin changes depending on the common mode voltage. When SENSE⁻ is less than $\text{INTV}_{\text{CC}} - 0.5\text{V}$, a small current of less than $1\mu\text{A}$ flows out of the pin. When SENSE⁻ is above $\text{INTV}_{\text{CC}} + 0.5\text{V}$, a higher current ($\approx 700\mu\text{A}$) flows into the pin. Between $\text{INTV}_{\text{CC}} - 0.5\text{V}$ and $\text{INTV}_{\text{CC}} + 0.5\text{V}$, the current transitions from the smaller current to the higher current.

Boost Controller (SENSE3⁺/SENSE3⁻): The common mode input range for these pins is 2.2V to 60V, allowing the boost converter to operate from inputs over this full range. The SENSE3⁺ pin also provides power to the current comparator and draws about $170\mu\text{A}$ during normal operation (when not shut down or asleep in Burst Mode operation). There is a small bias current of less than $1\mu\text{A}$ that flows into the SENSE3⁻ pin. This high impedance on

the SENSE3⁻ pin allows the current comparator to be used in inductor DCR sensing.

Filter components mutual to the sense lines should be placed close to the LTC3899, and the sense lines should run close together to a Kelvin connection underneath the current sense element (shown in Figure 1). Sensing current elsewhere can effectively add parasitic inductance and capacitance to the current sense element, degrading the information at the sense terminals and making the programmed current limit unpredictable. If DCR sensing is used (Figure 2b), R1 should be placed close to the switching node, to prevent noise from coupling into sensitive small-signal nodes.

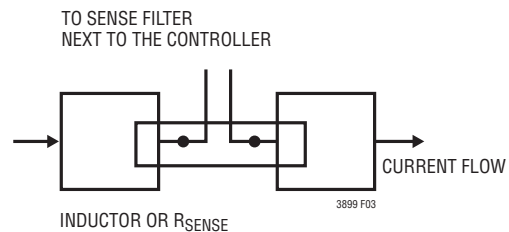

Figure 1. Sense Lines Placement with Inductor or Sense Resistor

Low Value Resistor Current Sensing

A typical sensing circuit using a discrete resistor is shown in Figure 2a. R_{SENSE} is chosen based on the required output current.

The current comparators have a maximum threshold $V_{SENSE(\text{MAX})}$ of 75mV. The current comparator threshold voltage sets the peak of the inductor current, yielding a maximum average output current, I_{MAX} , equal to the peak value less half the peak-to-peak ripple current, ΔI_L . To calculate the sense resistor value, use the equation:

$$R_{SENSE} = \frac{V_{SENSE(\text{MAX})}}{I_{\text{MAX}} + \frac{\Delta I_L}{2}}$$

When using the buck controllers in very low dropout conditions, the maximum output current level will be reduced due to the internal compensation required to meet stability criteria for buck regulators operating at greater than 50%

APPLICATIONS INFORMATION

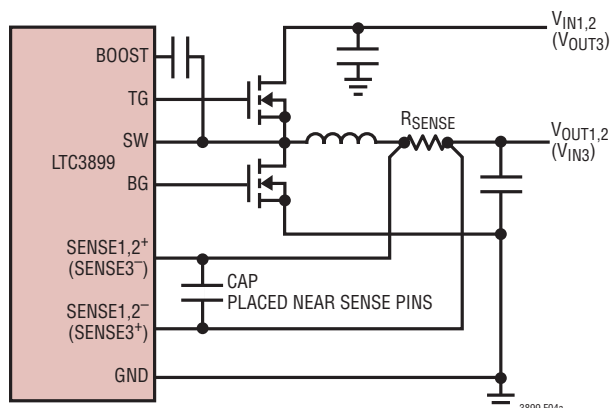

(2a) Using a Resistor to Sense Current

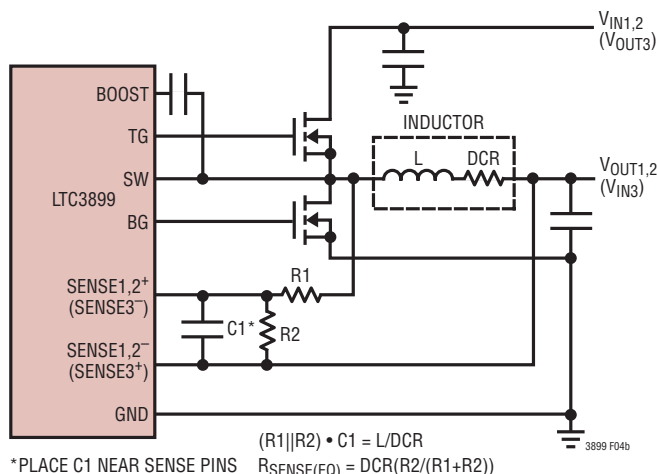

(2b) Using the Inductor DCR to Sense Current

Figure 2. Current Sensing Methods

duty factor. A curve is provided in the Typical Performance Characteristics section to estimate this reduction in peak inductor current depending upon the operating duty factor.

Inductor DCR Sensing

For applications requiring the highest possible efficiency at high load currents, the LTC3899 is capable of sensing the voltage drop across the inductor DCR, as shown in Figure 2b. The DCR of the inductor represents the small amount of DC winding resistance of the copper, which

can be less than 1mΩ for today's low value, high current inductors. In a high current application requiring such an inductor, power loss through a sense resistor would cost several points of efficiency compared to inductor DCR sensing.

If the external $(R1 \parallel R2) \cdot C1$ time constant is chosen to be exactly equal to the L/DCR time constant, the voltage drop across the external capacitor is equal to the drop across the inductor DCR multiplied by $R2/(R1 + R2)$. $R2$ scales the voltage across the sense terminals for applications where the DCR is greater than the target sense resistor value. To properly dimension the external filter components, the DCR of the inductor must be known. It can be measured using a good RLC meter, but the DCR tolerance is not always the same and varies with temperature; consult the manufacturers' data sheets for detailed information.

Using the inductor ripple current value from the Inductor Value Calculation section, the target sense resistor value is:

$$R_{SENSE(EQUIV)} = \frac{V_{SENSE(MAX)}}{I_{MAX} + \frac{\Delta I_L}{2}}$$

To ensure that the application will deliver full load current over the full operating temperature range, determine $R_{SENSE(EQUIV)}$, keeping in mind that the minimum value for the maximum current sense threshold ($V_{SENSE(MAX)}$) for the LTC3899 is 65mV.

Next, determine the DCR of the inductor. When provided, use the manufacturer's maximum value, usually given at 20°C. Increase this value to account for the temperature coefficient of copper resistance, which is approximately 0.4%/°C. A conservative value for $T_{L(MAX)}$ is 100°C.

To scale the maximum inductor DCR to the desired sense resistor value (R_D), use the divider ratio:

$$R_D = \frac{R_{SENSE(EQUIV)}}{DCR_{MAX} \text{ at } T_{L(MAX)}}$$

APPLICATIONS INFORMATION

C1 is usually selected to be in the range of 0.1 μ F to 0.47 μ F. This forces R1||R2 to around 2k, reducing error that might have been caused by the SENSE⁺ pin's $\pm 1\mu$ A current.

The equivalent resistance R1||R2 is scaled to the temperature inductance and maximum DCR:

$$R1||R2 = \frac{L}{(\text{DCR at } 20^\circ\text{C}) \cdot C1}$$

The sense resistor values are:

$$R1 = \frac{R1||R2}{R_D}; \quad R2 = \frac{R1 \cdot R_D}{1 - R_D}$$

The maximum power loss in R1 is related to duty cycle, and will occur in continuous mode at the maximum input voltage:

$$P_{\text{LOSS } R1} = \frac{(V_{\text{IN}(\text{MAX})} - V_{\text{OUT}}) \cdot V_{\text{OUT}}}{R1}$$

For the boost controller, the maximum power loss in R1 will occur in continuous mode at $V_{\text{IN}} = 1/2 \cdot V_{\text{OUT}}$:

$$P_{\text{LOSS } R1} = \frac{(V_{\text{OUT}(\text{MAX})} - V_{\text{IN}}) \cdot V_{\text{IN}}}{R1}$$

Ensure that R1 has a power rating higher than this value. If high efficiency is necessary at light loads, consider this power loss when deciding whether to use DCR sensing or sense resistors. Light load power loss can be modestly higher with a DCR network than with a sense resistor, due to the extra switching losses incurred through R1. However, DCR sensing eliminates a sense resistor, reduces conduction losses and provides higher efficiency at heavy loads. Peak efficiency is about the same with either method.

Inductor Value Calculation

The operating frequency and inductor selection are inter-related in that higher operating frequencies allow the use of smaller inductor and capacitor values. So why would anyone ever choose to operate at lower frequencies with larger components? The answer is efficiency. A higher frequency generally results in lower efficiency because of

MOSFET switching and gate charge losses. In addition to this basic trade-off, the effect of inductor value on ripple current and low current operation must also be considered.

The inductor value has a direct effect on ripple current. The inductor ripple current, ΔI_L , decreases with higher inductance or higher frequency. For the buck controllers, ΔI_L increases with higher V_{IN} :

$$\Delta I_L = \frac{1}{(f)(L)} V_{\text{OUT}} \left(1 - \frac{V_{\text{OUT}}}{V_{\text{IN}}} \right)$$

For the boost controller, ΔI_L increases with higher V_{OUT} :

$$\Delta I_L = \frac{1}{(f)(L)} V_{\text{IN}} \left(1 - \frac{V_{\text{IN}}}{V_{\text{OUT}}} \right)$$

Accepting larger values of ΔI_L allows the use of low inductances, but results in higher output voltage ripple and greater core losses. A reasonable starting point for setting ripple current is $\Delta I_L = 0.3(I_{\text{MAX}})$. The maximum ΔI_L occurs at the maximum input voltage for the bucks and $V_{\text{IN}} = 1/2 \cdot V_{\text{OUT}}$ for the boost.

The inductor value also has secondary effects. The transition to Burst Mode operation begins when the average inductor current required results in a peak current below 25% of the current limit (30% for the boost) determined by R_{SENSE} . Lower inductor values (higher ΔI_L) will cause this to occur at lower load currents, which can cause a dip in efficiency in the upper range of low current operation. In Burst Mode operation, lower inductance values will cause the burst frequency to decrease.

Inductor Core Selection

Once the value for L is known, the type of inductor must be selected. High efficiency converters generally cannot afford the core loss found in low cost powdered iron cores, forcing the use of more expensive ferrite or molypermalloy cores. Actual core loss is independent of core size for a fixed inductor value, but it is very dependent on inductance value selected. As inductance increases, core losses go down. Unfortunately, increased inductance requires more turns of wire and therefore copper losses will increase.

APPLICATIONS INFORMATION

Ferrite designs have very low core loss and are preferred for high switching frequencies, so design goals can concentrate on copper loss and preventing saturation. Ferrite core material saturates hard, which means that inductance collapses abruptly when the peak design current is exceeded. This results in an abrupt increase in inductor ripple current and consequent output voltage ripple. Do not allow the core to saturate!

Power MOSFET and Schottky Diode (Optional) Selection

Two external power MOSFETs must be selected for each controller in the LTC3899: one N-channel MOSFET for the top switch (main switch for the bucks, synchronous for the boost), and one N-channel MOSFET for the bottom switch (main switch for the boost, synchronous for the bucks).

The peak-to-peak drive levels are set by the DRV_{CC} voltage. This voltage can range from 5V to 10V depending on configuration of the $DRVSET$ pin. Therefore, both logic-level and standard-level threshold MOSFETs can be used in most applications depending on the programmed DRV_{CC} voltage. Pay close attention to the BV_{DSS} specification for the MOSFETs as well.

The LTC3899's unique ability to adjust the gate drive level between 5V to 10V (OPTI-DRIVE) allows an application circuit to be precisely optimized for efficiency. When adjusting the gate drive level, the final arbiter is the total input current for the regulator. If a change is made and the input current decreases, then the efficiency has improved. If there is no change in input current, then there is no change in efficiency.

Selection criteria for the power MOSFETs include the on-resistance $R_{DS(ON)}$, Miller capacitance C_{MILLER} , input voltage and maximum output current. Miller capacitance, C_{MILLER} , can be approximated from the gate charge curve usually provided on the MOSFET manufacturers' data sheet. C_{MILLER} is equal to the increase in gate charge along the horizontal axis while the curve is approximately flat divided by the specified change in V_{DS} . This result is then multiplied by the ratio of the application applied V_{DS} to the gate charge curve specified V_{DS} . When the IC is

operating in continuous mode the duty cycles for the top and bottom MOSFETs are given by:

$$\text{Buck Main Switch Duty Cycle} = \frac{V_{OUT}}{V_{IN}}$$

$$\text{Buck Sync Switch Duty Cycle} = \frac{V_{IN} - V_{OUT}}{V_{IN}}$$

$$\text{Boost Main Switch Duty Cycle} = \frac{V_{OUT} - V_{IN}}{V_{OUT}}$$

$$\text{Boost Sync Switch Duty Cycle} = \frac{V_{IN}}{V_{OUT}}$$

The MOSFET power dissipations at maximum output current are given by:

$$P_{MAIN_BUCK} = \frac{V_{OUT}}{V_{IN}} (I_{OUT(MAX)})^2 (1+\delta) R_{DS(ON)} +$$

$$(V_{IN})^2 \left(\frac{I_{OUT(MAX)}}{2} \right) (R_{DR})(C_{MILLER}) \cdot$$

$$\left[\frac{1}{V_{DRVCC} - V_{THMIN}} + \frac{1}{V_{THMIN}} \right] (f)$$

$$P_{SYNC_BUCK} = \frac{V_{IN} - V_{OUT}}{V_{IN}} (I_{OUT(MAX)})^2 (1+\delta) R_{DS(ON)}$$

$$P_{MAIN_BOOST} = \frac{(V_{OUT} - V_{IN}) V_{OUT}}{V_{IN}^2} (I_{OUT(MAX)})^2 \cdot$$

$$(1+\delta) R_{DS(ON)} + \left(\frac{V_{OUT}^3}{V_{IN}} \right) \left(\frac{I_{OUT(MAX)}}{2} \right) \cdot$$

$$(R_{DR})(C_{MILLER}) \cdot \left[\frac{1}{V_{DRVCC} - V_{THMIN}} + \frac{1}{V_{THMIN}} \right] (f)$$

$$P_{SYNC_BOOST} = \frac{V_{IN}}{V_{OUT}} (I_{OUT(MAX)})^2 (1+\delta) R_{DS(ON)}$$

where δ is the temperature dependency of $R_{DS(ON)}$ and R_{DR} (approximately 2Ω) is the effective driver resistance at the MOSFET's Miller threshold voltage. V_{THMIN} is the typical MOSFET minimum threshold voltage.

APPLICATIONS INFORMATION

Both MOSFETs have I^2R losses while the main N-channel equations for the buck and boost controllers include an additional term for transition losses, which are highest at high input voltages for the bucks and low input voltages for the boost. For $V_{IN} < 20V$ (higher V_{IN} for the boost) the high current efficiency generally improves with larger MOSFETs, while for $V_{IN} > 20V$ (lower V_{IN} for the boost) the transition losses rapidly increase to the point that the use of a higher $R_{DS(ON)}$ device with lower C_{MILLER} actually provides higher efficiency. The synchronous MOSFET losses for the buck controllers are greatest at high input voltage when the top switch duty factor is low or during a short-circuit when the synchronous switch is on close to 100% of the period.

The term $(1 + \delta)$ is generally given for a MOSFET in the form of a normalized $R_{DS(ON)}$ vs Temperature curve, but $\delta = 0.005/^\circ C$ can be used as an approximation for low voltage MOSFETs.

Optional Schottky diodes placed across the synchronous MOSFET conduct during the dead-time between the conduction of the two power MOSFETs. This prevents the body diode of the synchronous MOSFET from turning on, storing charge during the dead-time and requiring a reverse recovery period that could cost as much as 3% in efficiency at high V_{IN} . A 1A to 3A Schottky is generally a good compromise for both regions of operation due to the relatively small average current. Larger diodes result in additional transition losses due to their larger junction capacitance.

Boost C_{IN} , C_{OUT} Selection

The input ripple current in a boost converter is relatively low (compared with the output ripple current), because this current is continuous. The boost input capacitor C_{IN} voltage rating should comfortably exceed the maximum input voltage. Although ceramic capacitors can be relatively tolerant of overvoltage conditions, aluminum electrolytic capacitors are not. Be sure to characterize the input voltage for any possible overvoltage transients that could apply excess stress to the input capacitors.

The value of C_{IN} is a function of the source impedance, and in general, the higher the source impedance, the higher the required input capacitance. The required amount of input capacitance is also greatly affected by the duty cycle. High output current applications that also experience high duty cycles can place great demands on the input supply, both in terms of DC current and ripple current.

In a boost converter, the output has a discontinuous current, so C_{OUT} must be capable of reducing the output voltage ripple. The effects of ESR (equivalent series resistance) and the bulk capacitance must be considered when choosing the right capacitor for a given output ripple voltage. The steady ripple due to charging and discharging the bulk capacitance is given by:

$$\text{Ripple} = \frac{I_{OUT(MAX)} \cdot (V_{OUT} - V_{IN(MIN)})}{C_{OUT} \cdot V_{OUT} \cdot f} V$$

where C_{OUT} is the output filter capacitor.

The steady ripple due to the voltage drop across the ESR is given by:

$$\Delta V_{ESR} = I_{L(MAX)} \cdot ESR$$

Multiple capacitors placed in parallel may be needed to meet the ESR and RMS current handling requirements. Dry tantalum, special polymer, aluminum electrolytic and ceramic capacitors are all available in surface mount packages. Ceramic capacitors have excellent low ESR characteristics but can have a high voltage coefficient. Capacitors are now available with low ESR and high ripple current ratings such as OS-CON and POSCAP.

Buck C_{IN} , C_{OUT} Selection

The selection of C_{IN} for the two buck controllers is simplified by the 2-phase architecture and its impact on the worst-case RMS current drawn through the input network (battery/fuse/capacitor). It can be shown that the worst-case capacitor RMS current occurs when only one controller is operating. The controller with the highest $(V_{OUT})(I_{OUT})$ product needs to be used in the formula shown in Equa-

APPLICATIONS INFORMATION

tion 1 to determine the maximum RMS capacitor current requirement. Increasing the output current drawn from the other controller will actually decrease the input RMS ripple current from its maximum value. The opt-of-phase technique typically reduces the input capacitor's RMS ripple current by a factor of 30% to 70% when compared to a single phase power supply solution.

In continuous mode, the source current of the top MOSFET is a square wave of duty cycle $(V_{OUT})/(V_{IN})$. To prevent large voltage transients, a low ESR capacitor sized for the maximum RMS current of one channel must be used. The maximum RMS capacitor current is given by:

$$C_{IN} \text{ Required } I_{RMS} \approx \frac{I_{MAX}}{V_{IN}} \left[(V_{OUT})(V_{IN} - V_{OUT}) \right]^{1/2} \quad (1)$$

This formula has a maximum at $V_{IN} = 2V_{OUT}$, where $I_{RMS} = I_{OUT}/2$. This simple worst-case condition is commonly used for design because even significant deviations do not offer much relief. Note that capacitor manufacturers' ripple current ratings are often based on only 2000 hours of life. This makes it advisable to further derate the capacitor, or to choose a capacitor rated at a higher temperature than required. Several capacitors may be paralleled to meet size or height requirements in the design. Due to the high operating frequency of the LTC3899, ceramic capacitors can also be used for C_{IN} . Always consult the manufacturer if there is any question.

The benefit of the LTC3899 2-phase operation can be calculated by using Equation 1 for the higher power controller and then calculating the loss that would have resulted if both controller channels switched on at the same time. The total RMS power lost is lower when both controllers are operating due to the reduced overlap of current pulses required through the input capacitor's ESR. This is why the input capacitor's requirement calculated above for the worst-case controller is adequate for the dual controller design. Also, the input protection fuse resistance, battery resistance, and PC board trace resistance losses are also reduced due to the reduced peak currents in a 2-phase system. The overall benefit of a multiphase design will only be fully realized when the source impedance of the

power supply/battery is included in the efficiency testing. The drains of the top MOSFETs should be placed within 1cm of each other and share a common $C_{IN}(s)$. Separating the drains and C_{IN} may produce undesirable voltage and current resonances at V_{IN} .

A small (0.1 μ F to 1 μ F) bypass capacitor between the chip V_{BIAS} pin and ground, placed close to the LTC3899, is also suggested. A 10 Ω resistor placed between C_{IN} (C1) and the V_{BIAS} pin provides further isolation.

The selection of C_{OUT} is driven by the effective series resistance (ESR). Typically, once the ESR requirement is satisfied, the capacitance is adequate for filtering. The output ripple (ΔV_{OUT}) is approximated by:

$$\Delta V_{OUT} \approx \Delta I_L \left(ESR + \frac{1}{8 \cdot f \cdot C_{OUT}} \right)$$

where f is the operating frequency, C_{OUT} is the output capacitance and ΔI_L is the ripple current in the inductor. The output ripple is highest at maximum input voltage since ΔI_L increases with input voltage.

Setting Buck Output Voltage

The LTC3899 output voltages for the buck controllers are set by an external feedback resistor divider carefully placed across the output, as shown in Figure 3. The regulated output voltage is determined by:

$$V_{OUT} = 0.8V \left(1 + \frac{R_B}{R_A} \right)$$

To improve the frequency response, a feedforward capacitor, C_{FF} , may be used. Great care should be taken to route the V_{FB} line away from noise sources, such as the inductor or the SW line.

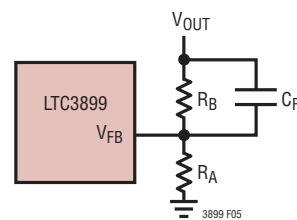

Figure 3. Setting Buck Output Voltage

APPLICATIONS INFORMATION

Setting Boost Output Voltage (VPRG3 Pin)

Through control of the VPRG3 pin the boost controller output voltage can be set by an external feedback resistor divider or programmed to a fixed 10V or 12V output.

Floating VPRG3 allows the boost output voltage to be set by an external feedback resistor divider placed across the output, as shown in Figure 4a. The regulated output voltage is determined by:

$$V_{OUT(BOOST)} = 1.2V \left(1 + \frac{R_B}{R_A} \right)$$

Tying the VPRG3 to INTV_{CC} or GND configures the boost controller in fixed output voltage mode. Figure 4b shows how the V_{FB3} pin is used to sense the output voltage in this mode. Tying VPRG3 to INTV_{CC} programs the boost output to 12V, whereas tying VPRG3 to GND programs the output to 10V.

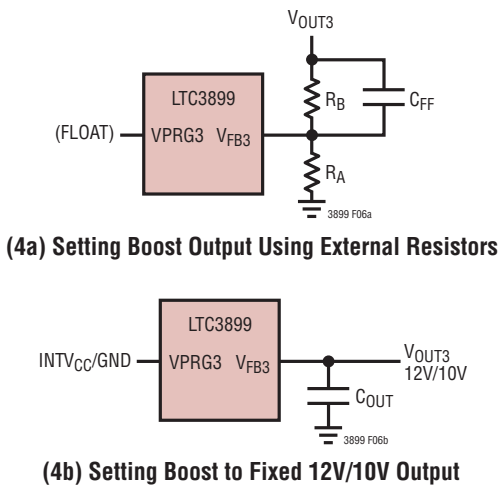

Figure 4. Setting CH3 Output Voltage

RUN Pins

The LTC3899 is enabled using the RUN1, RUN2 and RUN3 pins. The RUN pins have a rising threshold of 1.275V with 75mV of hysteresis. Pulling a RUN pin below 1.2V shuts down the main control loop for that channel. Pulling all three RUN pins below 0.7V disables the controllers and most internal circuits, including the DRV_{CC} and INTV_{CC}

LDOs. In this state, the LTC3899 draws only 3.6μA of quiescent current.

Releasing a RUN pin allows a small 150nA internal current to pull up the pin to enable that controller. Because of condensation or other small board leakage pulling the pin down, it is recommended the RUN pins be externally pulled up or driven directly by logic. Each RUN pin can tolerate up to 65V (absolute maximum), so it can be conveniently tied to V_{BIAS} in always-on applications where one or more controllers are enabled continuously and never shut down.

The RUN pins can be implemented as a UVLO by connecting them to the output of an external resistor divider network off V_{BIAS}, as shown in Figure 5.

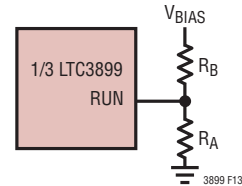

Figure 5. Using the RUN Pins as a UVLO

The rising and falling UVLO thresholds are calculated using the RUN pin thresholds and pull-up current:

$$V_{UVLO(RISING)} = 1.275V \left(1 + \frac{R_B}{R_A} \right) - 150nA \cdot R_B$$

$$V_{UVLO(FALLING)} = 1.20V \left(1 + \frac{R_B}{R_A} \right) - 150nA \cdot R_B$$

Tracking and Soft-Start (TRACK/SS1, TRACK/SS2, SS3 Pins)

The start-up of each V_{OUT} is controlled by the voltage on the TRACK/SS pin (TRACK/SS1 for channel 1, TRACK/SS2 for channel 2, SS3 for channel 3). When the voltage on the TRACK/SS pin is less than the internal 0.8V reference (1.2V reference for the boost channel), the LTC3899 regulates the V_{FB} pin voltage to the voltage on the TRACK/SS pin instead of the internal reference. The TRACK/SS pin can be used to program an external soft-start function or to allow V_{OUT} to track another supply during start-up.

APPLICATIONS INFORMATION

Soft-start is enabled by simply connecting a capacitor from the TRACK/SS pin to ground, as shown in Figure 6. An internal 10 μ A current source charges the capacitor, providing a linear ramping voltage at the TRACK/SS pin. The LTC3899 will regulate its feedback voltage (and hence V_{OUT}) according to the voltage on the TRACK/SS pin, allowing V_{OUT} to rise smoothly from 0V (V_{IN} for the boost) to its final regulated value. The total soft-start time will be approximately:

$$t_{SS_BUCK} = C_{SS} \cdot \frac{0.8V}{10\mu A}$$

$$t_{SS_BOOST} = C_{SS} \cdot \frac{1.2V}{10\mu A}$$

Alternatively, the TRACK/SS1 and TRACK/SS2 pins for the two buck controllers can be used to track two (or more) supplies during start-up, as shown qualitatively in Figures 7a and 7b. To do this, a resistor divider should be connected from the master supply (V_X) to the TRACK/SS pin of the slave supply (V_{OUT}), as shown in Figure 8. During start-up V_{OUT} will track V_X according to the ratio set by the resistor divider:

$$\frac{V_X}{V_{OUT}} = \frac{R_A}{R_{TRACKA}} \cdot \frac{R_{TRACKA} + R_{TRACKB}}{R_A + R_B}$$

For coincident tracking ($V_{OUT} = V_X$ during start-up),

$$R_A = R_{TRACKA}$$

$$R_B = R_{TRACKB}$$

DRV_{CC} and INTV_{CC} Regulators (OPTI-DRIVE)

The LTC3899 features two separate internal P-channel low dropout linear regulators (LDO) that supply power at the DRV_{CC} pin from either the V_{BIAS} supply pin or the EXT_V_{CC} pin depending on the connections of the EXT_V_{CC} and DRVSET pins. A third P-channel LDO supplies power at the INTV_{CC} pin from the DRV_{CC} pin. DRV_{CC} powers the gate drivers whereas INTV_{CC} powers much of the LTC3899's internal circuitry. The V_{BIAS} LDO and the EXT_V_{CC} LDO regulate DRV_{CC} between 5V to 10V, depending on how the DRVSET pin is set. Each of these LDOs can supply a

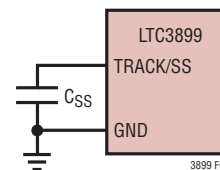
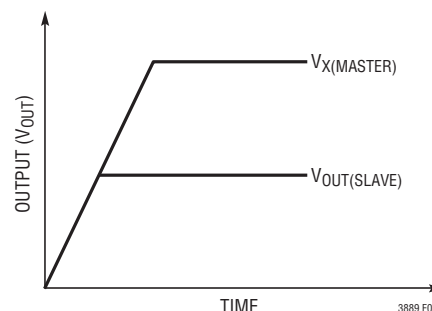
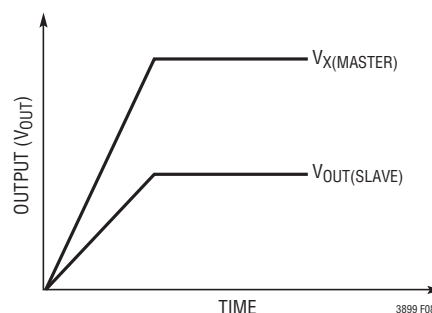

Figure 6. Using the TRACK/SS Pin to Program Soft-Start



(7a) Coincident Tracking



(7b) Ratiometric Tracking

Figure 7. Two Different Modes of Output Voltage Tracking

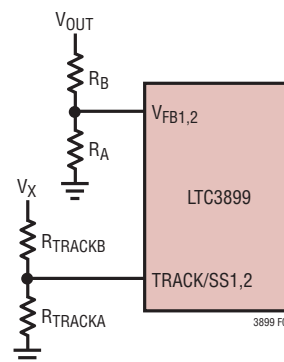

Figure 8. Using the TRACK/SS Pin for Tracking

APPLICATIONS INFORMATION

peak current of at least 50mA and must be bypassed to ground with a minimum of 4.7 μ F ceramic capacitor. Good bypassing is needed to supply the high transient currents required by the MOSFET gate drivers and to prevent interaction between the channels. The INTV_{CC} supply must be bypassed with a 0.1 μ F ceramic capacitor.

The DRVSET pin programs the DRV_{CC} supply voltage as well as the DRV_{CC} UVLO and EXTV_{CC} switchover threshold voltages. Table 1 summarizes the different DRVSET pin configurations along with the voltage settings that go with each configuration. Tying the DRVSET pin to INTV_{CC} programs DRV_{CC} to 10V and chooses the higher UVLO/EXTV_{CC} thresholds. Tying the DRVSET pin to GND programs DRV_{CC} to 6V and chooses the lower UVLO/EXTV_{CC} thresholds. By placing a 50k to 100k resistor between DRVSET and GND the DRV_{CC} voltage can be programmed between 5V to 10V, as shown in Figure 9. With a resistor on DRVSET, the lower UVLO/EXTV_{CC} thresholds are chosen.

Table 1

DRVSET PIN	DRV _{CC} VOLTAGE	DRV _{CC} UVLO RISING / FALLING THRESHOLDS	EXTV _{CC} SWITCHOVER THRESHOLD
0V	6V	4.0V / 3.8V	4.7V
INTV _{CC}	10V	7.5V / 6.7V	7.7V
Resistor to GND 50k to 100k	5V to 10V	4.0V / 3.8V	4.7V

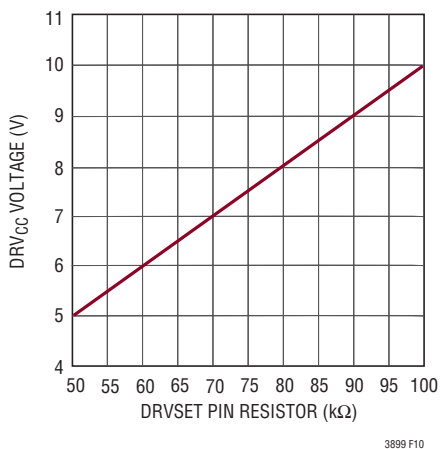

Figure 9. Relationship Between DRV_{CC} Voltage and Resistor Value at DRVSET Pin

High input voltage applications in which large MOSFETs are being driven at high frequencies may cause the maximum junction temperature rating for the LTC3899 to be exceeded. The DRV_{CC} current, which is dominated by the gate charge current, may be supplied by either the V_{BIAS} LDO or the EXTV_{CC} LDO. When the voltage on the EXTV_{CC} pin is less than its switchover threshold (4.7V or 7.7V as determined by the DRVSET pin described above), the V_{BIAS} LDO is enabled. Power dissipation for the IC in this case is highest and is equal to V_{BIAS} • I_{DRVCC}. The gate charge current is dependent on operating frequency as discussed in the Efficiency Considerations section. The junction temperature can be estimated by using the equations given in Note 2 of the Electrical Characteristics. For example, using the LTC3899 in the QFN package, the DRV_{CC} current is limited to less than 40mA from a 40V supply when not using the EXTV_{CC} supply at a 70°C ambient temperature:

$$T_J = 70^\circ\text{C} + (40\text{mA})(40\text{V})(34^\circ\text{C/W}) = 125^\circ\text{C}$$

To prevent the maximum junction temperature from being exceeded, the V_{BIAS} supply current must be checked while operating in forced continuous mode (PLLIN/MODE = INTV_{CC}) at maximum V_{BIAS}.

When the voltage applied to EXTV_{CC} rises above its switchover threshold, the V_{BIAS} LDO is turned off and the EXTV_{CC} LDO is enabled. The EXTV_{CC} LDO remains on as long as the voltage applied to EXTV_{CC} remains above the switchover threshold minus the comparator hysteresis. The EXTV_{CC} LDO attempts to regulate the DRV_{CC} voltage to the voltage as programmed by the DRVSET pin, so while EXTV_{CC} is less than this voltage, the LDO is in dropout and the DRV_{CC} voltage is approximately equal to EXTV_{CC}. When EXTV_{CC} is greater than the programmed voltage, up to an absolute maximum of 14V, DRV_{CC} is regulated to the programmed voltage.

Using the EXTV_{CC} LDO allows the MOSFET driver and control power to be derived from one of the LTC3899's switching regulator outputs (4.7V/7.7V ≤ V_{OUT} ≤ 14V) during normal operation and from the V_{BIAS} LDO when the output is out of regulation (e.g., start-up, short circuit). If more current is required through the EXTV_{CC} LDO than is specified, an external Schottky diode can be added

APPLICATIONS INFORMATION

between the $EXTV_{CC}$ and DRV_{CC} pins. In this case, do not apply more than 10V to the $EXTV_{CC}$ pin and make sure that $EXTV_{CC} \leq V_{BIAS}$.

Significant efficiency and thermal gains can be realized by powering DRV_{CC} from the output, since the V_{IN} current resulting from the driver and control currents will be scaled by a factor of (Duty Cycle)/(Switcher Efficiency).

For 5V to 14V regulator outputs, this means connecting the $EXTV_{CC}$ pin directly to V_{OUT} . Tying the $EXTV_{CC}$ pin to an 8.5V supply reduces the junction temperature in the previous example from 125°C to:

$$T_J = 70^\circ\text{C} + (40\text{mA})(8.5\text{V})(34^\circ\text{C}/\text{W}) = 82^\circ\text{C}$$

However, for 3.3V and other low voltage outputs, additional circuitry is required to derive DRV_{CC} power from the output.

The following list summarizes the four possible connections for $EXTV_{CC}$:

1. $EXTV_{CC}$ grounded. This will cause DRV_{CC} to be powered from the internal V_{BIAS} regulator resulting in increased power dissipation in the LTC3899 at high input voltages.
2. $EXTV_{CC}$ connected directly to the output of one of the buck regulators. This is the normal connection for a 5V to 14V regulator and provides the highest efficiency.
3. $EXTV_{CC}$ connected to an external supply. If an external supply is available in the 5V to 14V range, it may be used to power $EXTV_{CC}$ providing it is compatible with the MOSFET gate drive requirements. Ensure that $EXTV_{CC} < V_{BIAS}$.
4. $EXTV_{CC}$ connected to an output-derived boost network off one of the buck regulators. For 3.3V and other low voltage regulators, efficiency gains can still be realized by connecting $EXTV_{CC}$ to an output-derived voltage that has been boosted to greater than 4.7V/7.7V.

Topside MOSFET Driver Supply (C_B)

External bootstrap capacitors, C_B , connected to the BOOST pins supply the gate drive voltage for the topside MOSFET. The LTC3899 features an internal switch between DRV_{CC} and the BOOST pin for each controller. These internal switches eliminate the need for external bootstrap diodes

between DRV_{CC} and BOOST. Capacitor C_B in the Functional Diagram is charged through this internal switch from DRV_{CC} when the SW pin is low. When the topside MOSFET is to be turned on, the driver places the C_B voltage across the gate-source of the MOSFET. This enhances the top MOSFET switch and turns it on. The switch node voltage, SW, rises to V_{IN} and the BOOST pin follows. With the topside MOSFET on, the boost voltage is above the input supply: $V_{BOOST} = V_{IN} + V_{DRVCC}$ ($V_{BOOST} = V_{OUT} + V_{DRVCC}$ for the boost controller). The value of the boost capacitor, C_B , needs to be 100 times that of the total input capacitance of the topside MOSFET(s).

Fault Conditions: Buck Current Limit and Current Foldback

The LTC3899 includes current foldback for the buck channels to help limit load current when the output is shorted to ground. If the buck output voltage falls below 70% of its nominal output level, then the maximum sense voltage is progressively lowered from 100% to 40% of its maximum selected value. Under short-circuit conditions with very low duty cycles, the buck channel will begin cycle skipping in order to limit the short-circuit current. In this situation the bottom MOSFET will be dissipating most of the power but less than in normal operation. The short-circuit ripple current is determined by the minimum on-time, $t_{ON(MIN)}$, of the LTC3899 ($\approx 80\text{ns}$), the input voltage and inductor value:

$$\Delta I_{L(SC)} = t_{ON(MIN)} \left(\frac{V_{IN}}{L} \right)$$

The resulting average short-circuit current is:

$$I_{SC} = 40\% \cdot I_{LIM(MAX)} - \frac{1}{2} \Delta I_{L(SC)}$$

Fault Conditions: Buck Overvoltage Protection (Crowbar)

The overvoltage crowbar is designed to blow a system input fuse when the output voltage of one of the buck regulators rises much higher than nominal levels. The crowbar causes huge currents to flow, that blow the fuse

APPLICATIONS INFORMATION

to protect against a shorted top MOSFET if the short occurs while the controller is operating.

A comparator monitors the buck output for overvoltage conditions. The comparator detects faults greater than 10% above the nominal output voltage. When this condition is sensed, the top MOSFET is turned off and the bottom MOSFET is turned on until the overvoltage condition is cleared. The bottom MOSFET remains on continuously for as long as the overvoltage condition persists; if V_{OUT} returns to a safe level, normal operation automatically resumes.

A shorted top MOSFET will result in a high current condition which will open the system fuse. The switching regulator will regulate properly with a leaky top MOSFET by altering the duty cycle to accommodate the leakage.

Fault Conditions: Overtemperature Protection

At higher temperatures, or in cases where the internal power dissipation causes excessive self heating on chip (such as DRV_{CC} short to ground), the overtemperature shutdown circuitry will shut down the LTC3899. When the junction temperature exceeds approximately 175°C, the overtemperature circuitry disables the DRV_{CC} LDO, causing the DRV_{CC} supply to collapse and effectively shutting down the entire LTC3899 chip. Once the junction temperature drops back to the approximately 155°C, the DRV_{CC} LDO turns back on. Long-term overstress ($T_J > 125^\circ\text{C}$) should be avoided as it can degrade the performance or shorten the life of the part.

Phase-Locked Loop and Frequency Synchronization

The LTC3899 has an internal phase-locked loop (PLL) comprised of a phase frequency detector, a lowpass filter, and a voltage-controlled oscillator (VCO). This allows the turn-on of the top MOSFET of controller 1 to be locked to the rising edge of an external clock signal applied to the PLLIN/MODE pin. The turn-on of controller 2's top MOSFET is thus 180° out of phase with the external clock. The phase detector is an edge sensitive digital type that provides zero degrees phase shift between the external and internal oscillators. This type of phase detector does not exhibit false lock to harmonics of the external clock.

If the external clock frequency is greater than the internal oscillator's frequency, f_{OSC} , then current is sourced continuously from the phase detector output, pulling up the VCO input. When the external clock frequency is less than f_{OSC} , current is sunk continuously, pulling down the VCO input.

If the external and internal frequencies are the same but exhibit a phase difference, the current sources turn on for an amount of time corresponding to the phase difference. The voltage at the VCO input is adjusted until the phase and frequency of the internal and external oscillators are identical. At the stable operating point, the phase detector output is high impedance and the internal filter capacitor, CLP, holds the voltage at the VCO input.

Note that the LTC3899 can only be synchronized to an external clock whose frequency is within range of the LTC3899's internal VCO, which is nominally 55kHz to 1MHz. This is guaranteed to be between 75kHz and 850kHz. Typically, the external clock (on the PLLIN/MODE pin) input high threshold is 1.6V, while the input low threshold is 1.1V. The LTC3899 is guaranteed to synchronize to an external clock that swings up to at least 2.5V and down to 0.5V or less.

Rapid phase locking can be achieved by using the FREQ pin to set a free-running frequency near the desired synchronization frequency. The VCO's input voltage is prebiased at a frequency corresponding to the frequency set by the FREQ pin. Once prebiased, the PLL only needs to adjust the frequency slightly to achieve phase lock and synchronization. Although it is not required that the free-running frequency be near the external clock frequency, doing so will prevent the operating frequency from passing through a large range of frequencies as the PLL locks.

Table 2 summarizes the different states in which the FREQ pin can be used.

Table 2

FREQ PIN	PLLIN/MODE PIN	FREQUENCY
0V	DC Voltage	350kHz
INTV _{CC}	DC Voltage	535kHz
Resistor to GND	DC Voltage	50kHz to 900kHz
Any of the Above	External Clock 75kHz to 850kHz	Phase Locked to External Clock

APPLICATIONS INFORMATION

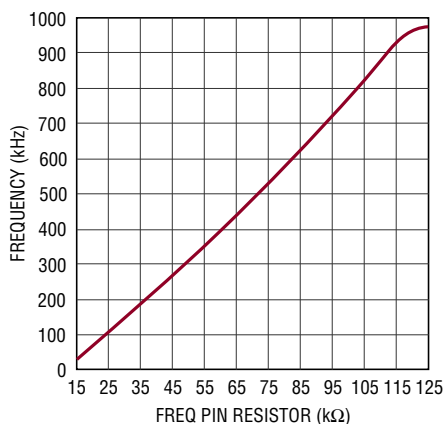

Figure 10. Relationship Between Oscillator Frequency and Resistor Value at the FREQ Pin

Minimum On-Time Considerations

Minimum on-time, $t_{ON(MIN)}$, is the smallest time duration that the LTC3899 is capable of turning on the top MOSFET (bottom MOSFET for the boost controller). It is determined by internal timing delays and the gate charge required to turn on the top MOSFET. Low duty cycle applications may approach this minimum on-time limit and care should be taken to ensure that:

$$t_{ON(MIN)_BUCK} < \frac{V_{OUT}}{V_{IN}(f)}$$

$$t_{ON(MIN)_BOOST} < \frac{V_{OUT} - V_{IN}}{V_{OUT}(f)}$$

If the duty cycle falls below what can be accommodated by the minimum on-time, the controller will begin to skip cycles. The output voltage will continue to be regulated, but the ripple voltage and current will increase.

The minimum on-time for the LTC3899 is approximately 80ns for the bucks and 120ns for the boost. However, for the buck channels as the peak sense voltage decreases the minimum on-time gradually increases up to about 130ns. This is of particular concern in forced continuous applications with low ripple current at light loads. If the duty cycle drops below the minimum on-time limit in this situation, a significant amount of cycle skipping can occur with correspondingly larger current and voltage ripple.

Efficiency Considerations

The percent efficiency of a switching regulator is equal to the output power divided by the input power times 100%. It is often useful to analyze individual losses to determine what is limiting the efficiency and which change would produce the most improvement. Percent efficiency can be expressed as:

$$\% \text{Efficiency} = 100\% - (L1 + L2 + L3 + \dots)$$

where L1, L2, etc. are the individual losses as a percentage of input power.

Although all dissipative elements in the circuit produce losses, four main sources usually account for most of the losses in LTC3899 circuits: 1) IC V_{BIAS} current, 2) DRV_{CC} regulator current, 3) I^2R losses, 4) Topside MOSFET transition losses.

1. The V_{BIAS} current is the DC supply current given in the Electrical Characteristics table, which excludes MOSFET driver and control currents. V_{BIAS} current typically results in a small (<0.1%) loss.
2. DRV_{CC} current is the sum of the MOSFET driver and control currents. The MOSFET driver current results from switching the gate capacitance of the power MOSFETs. Each time a MOSFET gate is switched from low to high to low again, a packet of charge, dQ , moves from DRV_{CC} to ground. The resulting dQ/dt is a current out of DRV_{CC} that is typically much larger than the control circuit current. In continuous mode, $I_{GATECHG} = f(Q_T + Q_B)$, where Q_T and Q_B are the gate charges of the topside and bottom side MOSFETs.

Supplying DRV_{CC} from an output-derived source power through $EXTV_{CC}$ will scale the V_{IN} current required for the driver and control circuits by a factor of (Duty Cycle)/(Efficiency). For example, in a 20V to 5V application, 10mA of DRV_{CC} current results in approximately 2.5mA of V_{IN} current. This reduces the midcurrent loss from 10% or more (if the driver was powered directly from V_{IN}) to only a few percent.

3. I^2R losses are predicted from the DC resistances of the fuse (if used), MOSFET, inductor, current sense resistor and input and output capacitor ESR. In continuous

APPLICATIONS INFORMATION

mode the average output current flows through L and R_{SENSE} , but is chopped between the topline MOSFET and the synchronous MOSFET. If the two MOSFETs have approximately the same $R_{DS(ON)}$, then the resistance of one MOSFET can simply be summed with the resistances of L, R_{SENSE} and ESR to obtain I^2R losses. For example, if each $R_{DS(ON)} = 30m\Omega$, $R_L = 50m\Omega$, $R_{SENSE} = 10m\Omega$ and $R_{ESR} = 40m\Omega$ (sum of both input and output capacitance losses), then the total resistance is $130m\Omega$. This results in losses ranging from 3% to 13% as the output current increases from 1A to 5A for a 5V output, or a 4% to 20% loss for a 3.3V output. Efficiency varies as the inverse square of V_{OUT} for the same external components and output power level. The combined effects of increasingly lower output voltages and higher currents required by high performance digital systems is not doubling but quadrupling the importance of loss terms in the switching regulator system!

- Transition losses apply only to the top MOSFET(s) (bottom MOSFET for the boost), and become significant only when operating at high input (output for the boost) voltages (typically 20V or greater). Transition losses can be estimated from:

$$\text{Transition Loss} = (1.7) \cdot V_{IN}^2 \cdot I_{O(MAX)} \cdot C_{RSS} \cdot f$$

Other hidden losses such as copper trace and internal battery resistances can account for an additional 5% to 10% efficiency degradation in portable systems. It is very important to include these system level losses during the design phase. The internal battery and fuse resistance losses can be minimized by making sure that C_{IN} has adequate charge storage and very low ESR at the switching frequency. A 25W supply will typically require a minimum of $20\mu F$ to $40\mu F$ of capacitance having a maximum of $20m\Omega$ to $50m\Omega$ of ESR. Other losses including Schottky conduction losses during dead-time and inductor core losses generally account for less than 2% total additional loss.

Checking Transient Response

The regulator loop response can be checked by looking at the load current transient response. Switching regulators take several cycles to respond to a step in DC (resistive)

load current. When a load step occurs, V_{OUT} shifts by an amount equal to $\Delta I_{LOAD(ESR)}$, where ESR is the effective series resistance of C_{OUT} . ΔI_{LOAD} also begins to charge or discharge C_{OUT} generating the feedback error signal that forces the regulator to adapt to the current change and return V_{OUT} to its steady-state value. During this recovery time V_{OUT} can be monitored for excessive overshoot or ringing, which would indicate a stability problem. OPTI-LOOP compensation allows the transient response to be optimized over a wide range of output capacitance and ESR values. The availability of the ITH pin not only allows optimization of control loop behavior, but it also provides a DC-coupled and AC-filtered closed-loop response test point. The DC step, rise time and settling at this test point truly reflects the closed-loop response. Assuming a predominantly second order system, phase margin and/or damping factor can be estimated using the percentage of overshoot seen at this pin. The bandwidth can also be estimated by examining the rise time at the pin. The ITH external components shown in Figure 12 circuit will provide an adequate starting point for most applications.

The ITH series R_C - C_C filter sets the dominant pole-zero loop compensation. The values can be modified slightly to optimize transient response once the final PC layout is done and the particular output capacitor type and value have been determined. The output capacitors need to be selected because the various types and values determine the loop gain and phase. An output current pulse of 20% to 80% of full-load current having a rise time of $1\mu s$ to $10\mu s$ will produce output voltage and ITH pin waveforms that will give a sense of the overall loop stability without breaking the feedback loop.

Placing a power MOSFET directly across the output capacitor and driving the gate with an appropriate signal generator is a practical way to produce a realistic load step condition. The initial output voltage step resulting from the step change in output current may not be within the bandwidth of the feedback loop, so this signal cannot be used to determine phase margin. This is why it is better to look at the ITH pin signal which is in the feedback loop and is the filtered and compensated control loop response.

The gain of the loop will be increased by increasing R_C and the bandwidth of the loop will be increased by de-

APPLICATIONS INFORMATION

creasing C_C . If R_C is increased by the same factor that C_C is decreased, the zero frequency will be kept the same, thereby keeping the phase shift the same in the most critical frequency range of the feedback loop. The output voltage settling behavior is related to the stability of the closed-loop system and will demonstrate the actual overall supply performance.

A second, more severe transient is caused by switching in loads with large ($>1\mu\text{F}$) supply bypass capacitors. The discharged bypass capacitors are effectively put in parallel with C_{OUT} , causing a rapid drop in V_{OUT} . No regulator can alter its delivery of current quickly enough to prevent this sudden step change in output voltage if the load switch resistance is low and it is driven quickly. If the ratio of C_{LOAD} to C_{OUT} is greater than 1:50, the switch rise-time should be controlled so that the load rise-time is limited to approximately $25 \cdot C_{LOAD}$. Thus a $10\mu\text{F}$ capacitor would require a $250\mu\text{s}$ rise time, limiting the charging current to about 200mA.

Buck Design Example

As a design example for one channel, assume $V_{IN} = 12\text{V}$ (nominal), $V_{IN} = 22\text{V}$ (maximum), $V_{OUT} = 3.3\text{V}$, $I_{MAX} = 5\text{A}$, $V_{SENSE(MAX)} = 75\text{mV}$ and $f = 350\text{kHz}$. The inductance value is chosen first based on a 30% ripple current assumption. The highest value of ripple current occurs at the maximum input voltage. Tie the FREQ pin to GND, generating 350kHz operation. The minimum inductance for 30% ripple current is:

$$\Delta I_L = \frac{V_{OUT}}{(f)(L)} \left(1 - \frac{V_{OUT}}{V_{IN(NOM)}} \right)$$

A $4.7\mu\text{H}$ inductor will produce 29% ripple current. The peak inductor current will be the maximum DC value plus one half the ripple current, or 5.73A. Increasing the ripple current will also help ensure that the minimum on-time of 80ns is not violated. The minimum on-time occurs at maximum V_{IN} :

$$t_{ON(MIN)} = \frac{V_{OUT}}{V_{IN(MAX)}(f)} = \frac{3.3\text{V}}{22\text{V}(350\text{kHz})} = 429\text{ns}$$

The equivalent R_{SENSE} resistor value can be calculated by using the minimum value for the maximum current sense threshold (65mV):

$$R_{SENSE} \leq \frac{65\text{mV}}{5.73\text{A}} \approx 0.01\Omega$$

Choosing 1% resistors: $R_A = 25\text{k}$ and $R_B = 78.7\text{k}$ yields an output voltage of 3.32V.

The power dissipation on the topside MOSFET can be easily estimated. Choosing a Fairchild FDS6982S dual MOSFET results in: $R_{DS(ON)} = 0.035\Omega/0.022\Omega$, $C_{MILLER} = 215\text{pF}$. At maximum input voltage with $T(\text{estimated}) = 50^\circ\text{C}$:

$$P_{MAIN} = \frac{3.3\text{V}}{22\text{V}} (5\text{A})^2 \left[1 + (0.005)(50^\circ\text{C} - 25^\circ\text{C}) \right] \\ (0.035\Omega) + (22\text{V})^2 \frac{5\text{A}}{2} (2.5\Omega)(215\text{pF}) \cdot \\ \left[\frac{1}{6\text{V} - 2.3\text{V}} + \frac{1}{2.3\text{V}} \right] (350\text{kHz}) = 308\text{mW}$$

A short-circuit to ground will result in a folded back current of:

$$I_{SC} = \frac{34\text{mV}}{0.01\Omega} - \frac{1}{2} \left(\frac{80\text{ns}(22\text{V})}{4.7\mu\text{H}} \right) = 3.21\text{A}$$

with a typical value of $R_{DS(ON)}$ and $\delta = (0.005/^\circ\text{C})(25^\circ\text{C}) = 0.125$. The resulting power dissipated in the bottom MOSFET is:

$$P_{SYNC} = (3.21\text{A})^2 (1.125) (0.022\Omega) = 255\text{mW}$$

which is less than under full-load conditions.

C_{IN} is chosen for an RMS current rating of at least 3A at temperature assuming only this channel is on. C_{OUT} is chosen with an ESR of 0.02Ω for low output ripple. The output ripple in continuous mode will be highest at the maximum input voltage. The output voltage ripple due to ESR is approximately:

$$V_{O(RIPPLE)} = R_{ESR} (\Delta I_L) = 0.02\Omega (1.45\text{A}) = 29\text{mV}_{P-P}$$

APPLICATIONS INFORMATION

PC Board Layout Checklist

When laying out the printed circuit board, the following checklist should be used to ensure proper operation of the IC. Figure 11 illustrates the current waveforms present in the various branches of the 2-phase synchronous buck regulators operating in the continuous mode. Check the following in your layout:

1. Are the top N-channel MOSFETs MTOP1 and MTOP2 located within 1cm of each other with a common drain connection at C_{IN} ? Do not attempt to split the input decoupling for the two channels as it can cause a large resonant loop.
2. Are the signal and power grounds kept separate? The combined IC signal ground pin and the ground return

of C_{DRVCC} must return to the combined C_{OUT} (-) terminals. The path formed by the top N-channel MOSFET, Schottky diode and the C_{IN} capacitor should have short leads and PC trace lengths. The output capacitor (-) terminals should be connected as close as possible to the (-) terminals of the input capacitor by placing the capacitors next to each other and away from the Schottky loop described above.

3. Does the LTC3899 V_{FB} pins' resistive divider connect to the (+) terminal of C_{OUT} ? The resistive divider must be connected between the (+) terminal of C_{OUT} and signal ground. The feedback resistor connections should not be along the high current input feeds from the input capacitor(s).

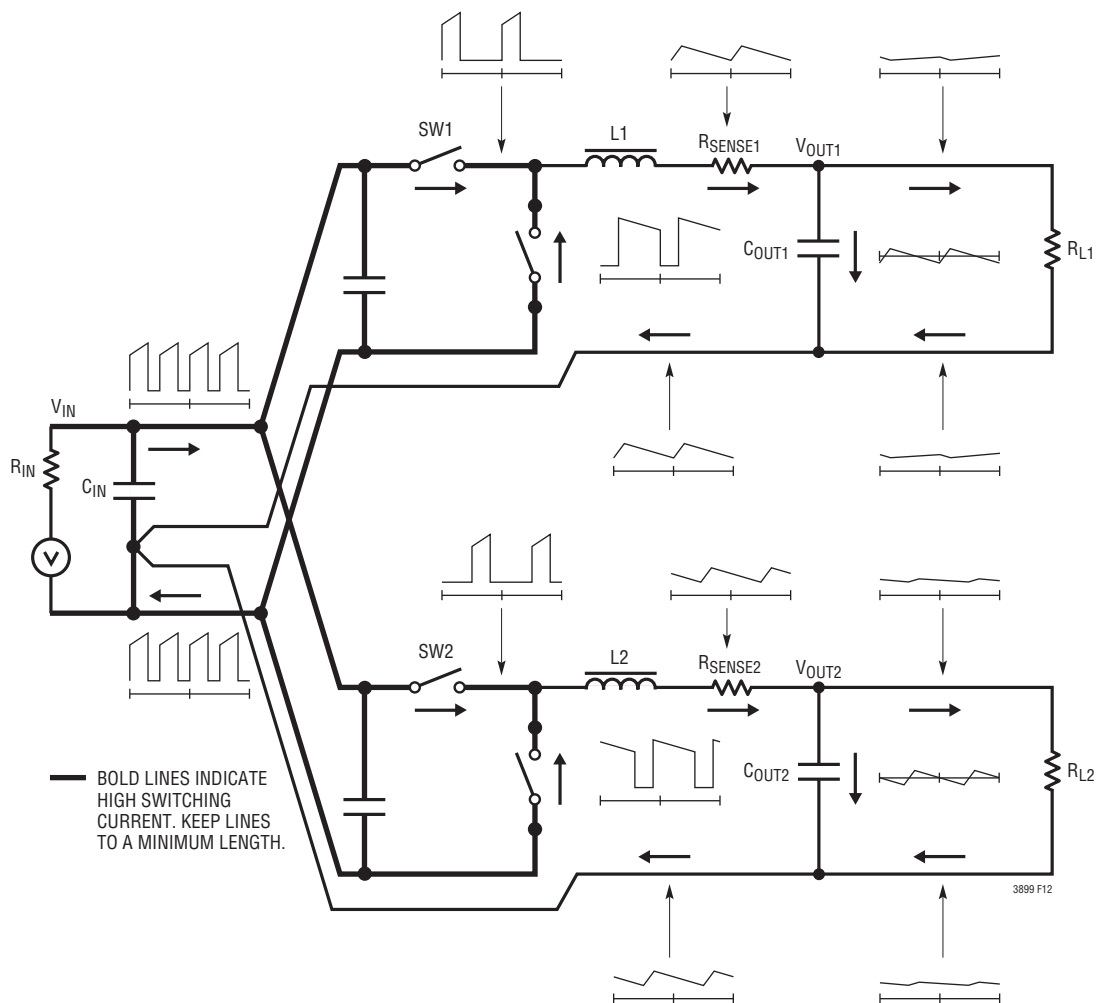

Figure 11. Branch Current Waveforms for Bucks

3899fa

APPLICATIONS INFORMATION

- Are the SENSE⁻ and SENSE⁺ leads routed together with minimum PC trace spacing? The filter capacitor between SENSE⁺ and SENSE⁻ should be as close as possible to the IC. Ensure accurate current sensing with Kelvin connections at the SENSE resistor.
- Is the DRV_{CC} and decoupling capacitor connected close to the IC, between the DRV_{CC} and the ground pin? This capacitor carries the MOSFET drivers' current peaks.
- Keep the switching nodes (SW1, SW2, SW3), top gate (TG1, TG2, TG3), and boost nodes (BOOST1, BOOST2, BOOST3) away from sensitive small-signal nodes, especially from the opposites channel's voltage and current sensing feedback pins. All of these nodes have very large and fast moving signals and therefore should be kept on the output side of the LTC3899 and occupy minimum PC trace area.
- Use a modified star ground technique: a low impedance, large copper area central grounding point on the same side of the PC board as the input and output capacitors with tie-ins for the bottom of the DRV_{CC} decoupling capacitor, the bottom of the voltage feedback resistive divider and the GND pin of the IC.

PC Board Layout Debugging

Start with one controller at a time. It is helpful to use a DC-50MHz current probe to monitor the current in the inductor while testing the circuit. Monitor the output switching node (SW pin) to synchronize the oscilloscope to the internal oscillator and probe the actual output voltage as well. Check for proper performance over the operating voltage and current range expected in the application. The frequency of operation should be maintained over the input voltage range down to dropout and until the output load drops below the low current operation threshold—typically 25% of the maximum designed current level in Burst Mode operation.

The duty cycle percentage should be maintained from cycle to cycle in a well-designed, low noise PCB implementation. Variation in the duty cycle at a subharmonic rate can suggest noise pickup at the current or voltage sensing inputs

or inadequate loop compensation. Overcompensation of the loop can be used to tame a poor PC layout if regulator bandwidth optimization is not required. Only after each controller is checked for its individual performance should both should multiple controllers be turned on at the same time. A particularly difficult region of operation is when one buck channel is nearing its current comparator trip point when the other buck channel is turning on its top MOSFET. This occurs around 50% duty cycle on either channel due to the phasing of the internal clocks and may cause minor duty cycle jitter.

Reduce V_{IN} from its nominal level to verify operation of the regulator in dropout. Check the operation of the undervoltage lockout circuit by further lowering V_{IN} while monitoring the outputs to verify operation.

Investigate whether any problems exist only at higher output currents or only at higher input voltages. If problems coincide with high input voltages and low output currents, look for capacitive coupling between the BOOST, SW, TG, and possibly BG connections and the sensitive voltage and current pins. The capacitor placed across the current sensing pins needs to be placed immediately adjacent to the pins of the IC. This capacitor helps to minimize the effects of differential noise injection due to high frequency capacitive coupling. If problems are encountered with high current output loading at lower input voltages, look for inductive coupling between C_{IN} , Schottky and the top MOSFET components to the sensitive current and voltage sensing traces. In addition, investigate common ground path voltage pickup between these components and the GND pin of the IC.

An embarrassing problem, which can be missed in an otherwise properly working switching regulator, results when the current sensing leads are hooked up backwards. The output voltage under this improper hookup will still be maintained but the advantages of current mode control will not be realized. Compensation of the voltage loop will be much more sensitive to component selection. This behavior can be investigated by temporarily shorting out the current sensing resistor—don't worry, the regulator will still maintain control of the output voltage.

TYPICAL APPLICATIONS

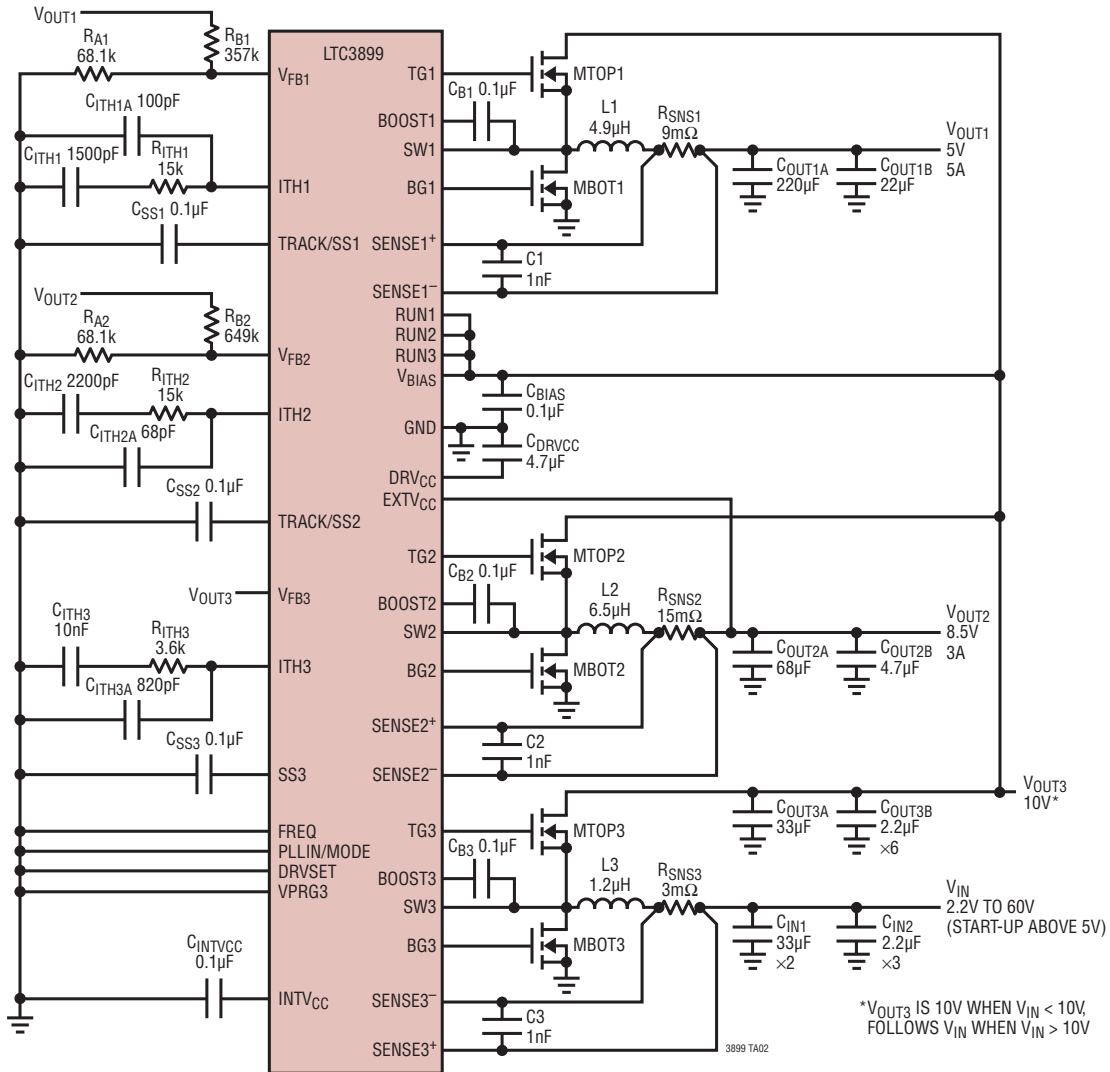
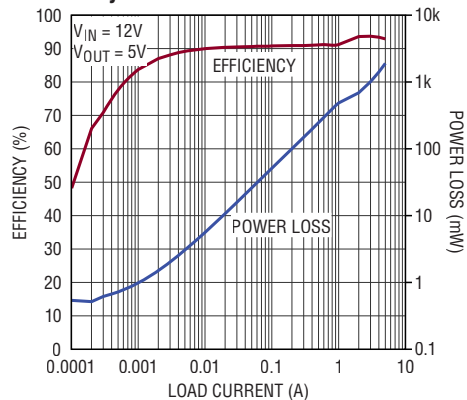

Figure 12. High Efficiency Wide Input Range Dual 5V/8.5V Converter

- MTOP1, MBOT1: B5Z123N08NS3
- MTOP2, MBOT2: B5Z123N08NS3
- MTOP3, MBOT3: B5C042NE7NS3
- L1: WURTH 744314490
- L2: WURTH 744314650
- L3: WURTH 744325120
- COU1A: SANYO 6TPB220ML
- COU2A: SANYO 10TPC68M
- CIN1, COU3A: SUNCON 63HVP33M

Efficiency and Power Loss vs Load Current



3899 TA02b

PACKAGE DESCRIPTION

Please refer to <http://www.linear.com/designtools/packaging/> for the most recent package drawings.

FE Package
38-Lead Plastic TSSOP (4.4mm)
 (Reference LTC DWG # 05-08-1772 Rev C)
Exposed Pad Variation AA

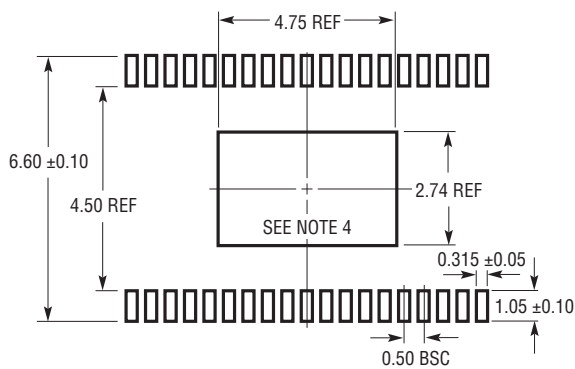

RECOMMENDED SOLDER PAD LAYOUT

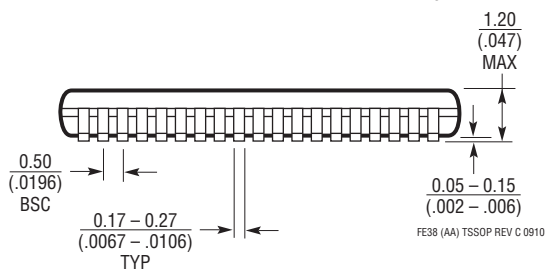
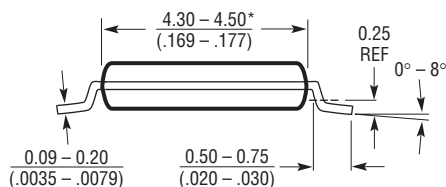
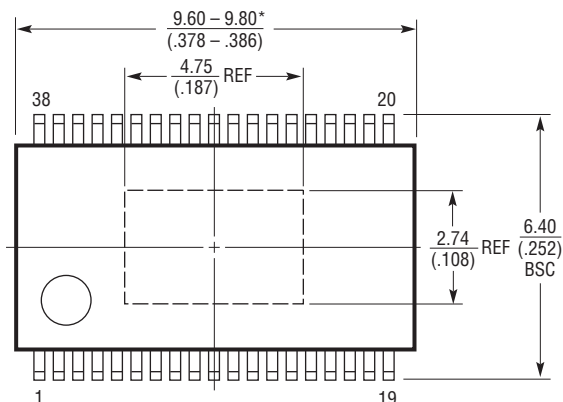

FE38 (AA) TSSOP REV C 0910

NOTE:

1. CONTROLLING DIMENSION: MILLIMETERS
2. DIMENSIONS ARE IN $\frac{\text{MILLIMETERS}}{\text{(INCHES)}}$
3. DRAWING NOT TO SCALE

4. RECOMMENDED MINIMUM PCB METAL SIZE FOR EXPOSED PAD ATTACHMENT
- *DIMENSIONS DO NOT INCLUDE MOLD FLASH. MOLD FLASH SHALL NOT EXCEED 0.150mm (.006") PER SIDE

PACKAGE DESCRIPTION

Please refer to <http://www.linear.com/designtools/packaging/> for the most recent package drawings.

UHF Package
38-Lead Plastic QFN (5mm × 7mm)
 (Reference LTC DWG # 05-08-1701 Rev C)

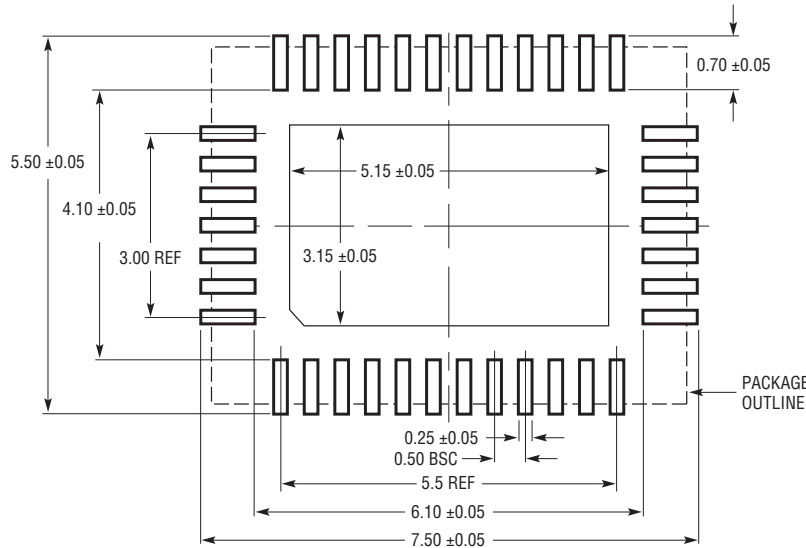

RECOMMENDED SOLDER PAD LAYOUT
 APPLY SOLDER MASK TO AREAS THAT ARE NOT SOLDERED

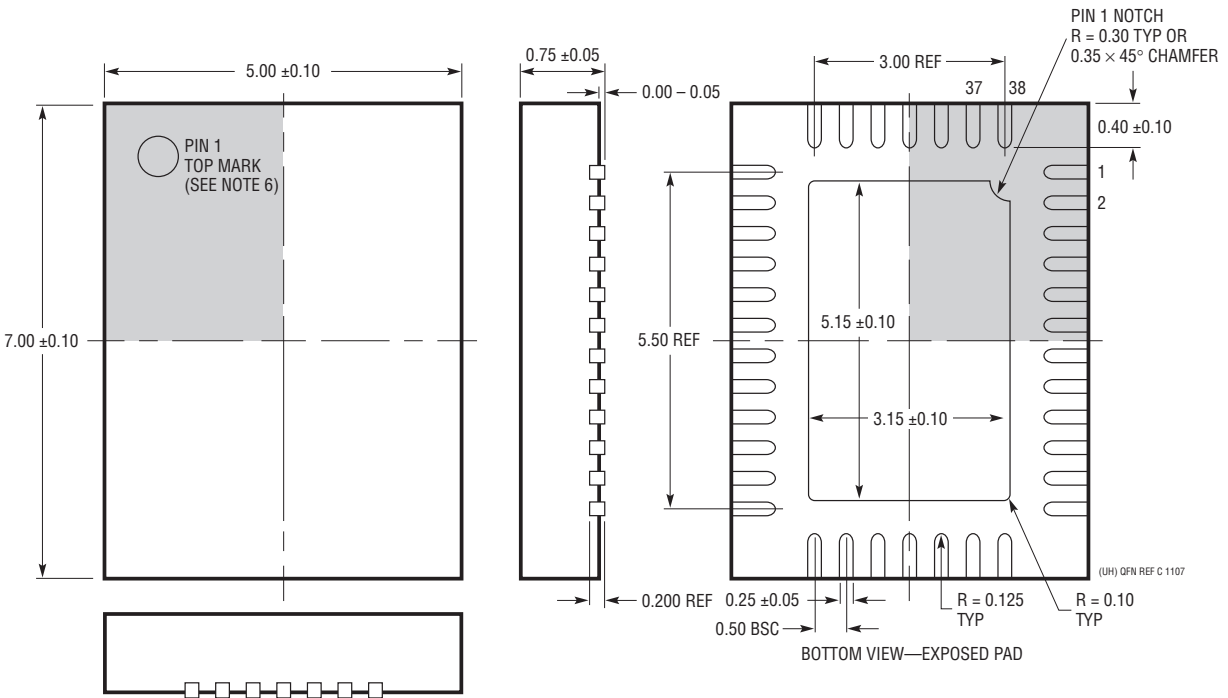

- NOTE:
1. DRAWING CONFORMS TO JEDEC PACKAGE OUTLINE MO-220 VARIATION WHKD
 2. DRAWING NOT TO SCALE
 3. ALL DIMENSIONS ARE IN MILLIMETERS

4. DIMENSIONS OF EXPOSED PAD ON BOTTOM OF PACKAGE DO NOT INCLUDE MOLD FLASH. MOLD FLASH, IF PRESENT, SHALL NOT EXCEED 0.20mm ON ANY SIDE
5. EXPOSED PAD SHALL BE SOLDER PLATED
6. SHADED AREA IS ONLY A REFERENCE FOR PIN 1 LOCATION ON THE TOP AND BOTTOM OF PACKAGE

REVISION HISTORY

REV	DATE	DESCRIPTION	PAGE NUMBER
A	09/15	Clarified INTV _{CC} Pin Functions SW1, SW2, SW3 pin callouts corrected Block Diagram modified	11 11 13, 14

TYPICAL APPLICATION

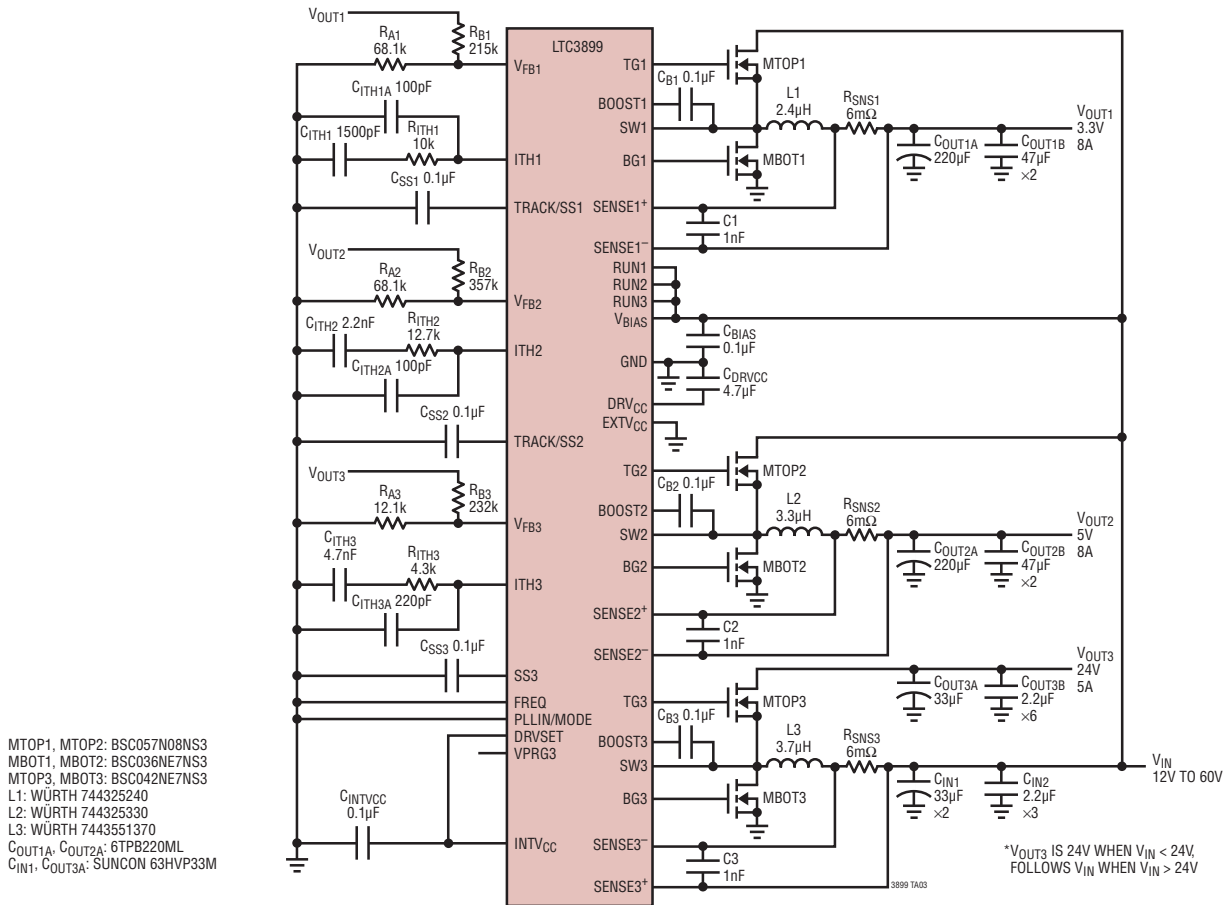

Figure 13. High Efficiency Triple 24V/3.3V/5V Converter with 10V Gate Drive

RELATED PARTS

PART NUMBER	DESCRIPTION	COMMENTS
LTC3859AL	Triple Output, Buck/Buck/Boost Synchronous Controller with 28μA Burst Mode I _Q	4.5V (Down to 2.5V After Start-Up) ≤ V _{IN} ≤ 38V, V _{OUT} Up to 60V, I _Q = 28μA, Buck V _{OUT} Range: 0.8V to 24V, Boost V _{OUT} Up to 60V
LTC3892/LTC3892-1	60V, Low I _Q , Dual 2-Phase Synchronous Step-Down DC/DC Controller with 99% Duty Cycle	PLL Fixed Frequency 50kHz to 900kHz, 4.5V ≤ V _{IN} ≤ 60V, 0.8V ≤ V _{OUT} ≤ 0.99V _{IN} , I _Q = 29μA
LTC3769	Low I _Q Synchronous Step-Up DC/DC Controller	4.5V (Down to 2.5V After Start-Up) ≤ V _{IN} ≤ 60V, V _{OUT} Up to 60V, I _Q = 28μA, PLL Fixed Frequency 50kHz to 900kHz, 4mm × 4mm QFN-24, TSSOP-20E
LTC3784	Low I _Q , Multiphase, Dual Channel Single Output Synchronous Step-Up DC/DC Controller	4.5V (Down to 2.5V After Start-Up) ≤ V _{IN} ≤ 60V, V _{OUT} Up to 60V, PLL Fixed Frequency 50kHz to 900kHz, I _Q = 28μA
LTC3890/LTC3890-1 LTC3890-2/LTC3890-3	60V, Low I _Q , Dual 2-Phase Synchronous Step-Down DC/DC Controller with 99% Duty Cycle	PLL Fixed Frequency 50kHz to 900kHz, 4V ≤ V _{IN} ≤ 60V, 0.8V ≤ V _{OUT} ≤ 24V, I _Q = 50μA
LTC3891	60V, Low I _Q , Synchronous Step-Down DC/DC Controller with 99% Duty Cycle	PLL Fixed Frequency 50kHz to 900kHz, 4V ≤ V _{IN} ≤ 60V, 0.8V ≤ V _{OUT} ≤ 24V, I _Q = 50μA
LTC3857/LTC3857-1 LTC3858/LTC3858-1	Low I _Q , Dual Output 2-Phase Synchronous Step-Down DC/DC Controller with 99% Duty Cycle	Phase-Lockable Fixed Operating Frequency 50kHz to 900kHz, 4V ≤ V _{IN} ≤ 38V, 0.8V ≤ V _{OUT} ≤ 24V, I _Q = 50μA/170μA
LTC3864	60V, Low I _Q , High Voltage DC/DC Controller with 100% Duty Cycle	Fixed Frequency 50kHz to 850kHz, 3.5V ≤ V _{IN} ≤ 60V, 0.8V ≤ V _{OUT} ≤ V _{IN} , I _Q = 40μA, MSOP-12E, 3mm × 4mm DFN-12
LT [®] 8705	80V V _{IN} and V _{OUT} Synchronous 4-Switch Buck-Boost DC/DC Controller	V _{IN} Range: 2.8V (Need EXT _{VCC} > 6.4V) to 80V, V _{OUT} Range: 1.3V to 80V; 4 Regulation Loops

3899fa