



Parameter	Rating	Units
Blocking Voltage	250	V_P
Load Current	200	mA_{rms} / mA_{DC}
On-Resistance (max)	15	Ω

Features

- Integrated Active Current-Limit Protection
- Thermal Shutdown
- Linear AC or DC Operation
- Low Power Consumption
- Clean, Bounce-free Switching
- High Surge Capability
- Low Power Drive Requirements
- Surface Mount version available
- Tape & Reel packaging available

Applications

- General Telecom Switching
 - Hook Switch
 - Ringing Relay
 - Dial Pulsing
 - Ground Start
 - Ground Fault Protection
- Instrumentation
 - Automatic Tuning/Balancing
 - Flying Capacitor
 - Analog Multiplex
- Peripherals
 - Automatic Tuning/Balancing
 - Transducer Driver
- Security
- Medical Equipment

Pin Configuration

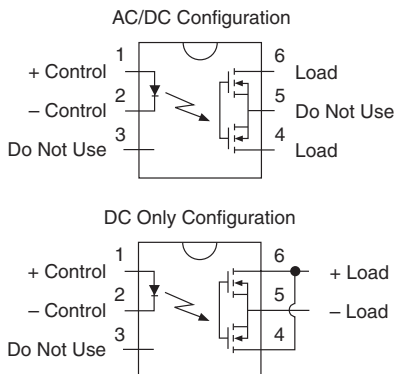

Description

The CPC1510 is a single-pole, normally open (1-Form-A) Solid State Relay with an integrated current limit feature that can replace electromechanical relays while enhancing the robustness of wireline-interface applications.

The relay is constructed using a GaAIAs LED for actuation control and an integrated monolithic die for the switch output. The die, fabricated in a high-voltage dielectrically isolated technology, comprises a photodiode array, switch control with active current limiting circuitry, and MOSFET switches. The active current limit circuitry in the CPC1510 also provides a thermal shutdown feature offering excellent power cross immunity for improved survivability in harsh environments.

These enhancements greatly improve the robustness of end systems using this device compared to systems using relays without the integrated current limit. In addition, the active current limit circuitry enables the CPC1510 to pass FCC 68.302 and other regulatory voltage surge requirements when adequate overvoltage protection is provided. The CPC1510 relay may be used in both unidirectional DC applications as well as bi-directional AC applications.

Approvals

- UL Approved Component: File # E76270
- CSA Certified Component: Certificate # 1172007
- EN/IEC 60950-1 Certified Component: Certificate B10 05 49410 006

Ordering Information

Part #	Description
CPC1510G	6-Pin 0.250" Wide, Through Hole (50/Tube)
CPC1510GS	6-Pin 0.250" Wide, Surface Mount (50/Tube)
CPC1510GSTR	6-Pin 0.250" Wide, Surface Mount (1000/Reel)

Switching Characteristics of Normally Open Devices

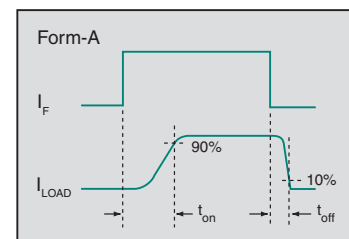

Absolute Maximum Ratings @ 25°C

Parameter	Ratings	Units
Blocking Voltage	250	V _P
Reverse Input Voltage	5	V
Input LED Current		
Continuous	50	mA
Peak (10ms)	1	A
Input Control Current	10	mA
Input Power Dissipation ¹	150	mW
Total Power Dissipation ²	800	mW
Isolation Voltage, Input to Output	3750	V _{rms}
Operational Temperature	-40 to +85	°C
Storage Temperature	-40 to +125	°C

Absolute Maximum Ratings are stress ratings. Stresses in excess of these ratings can cause permanent damage to the device. Functional operation of the device at conditions beyond those indicated in the operational sections of this data sheet is not implied.

¹ Derate Linearly 1.33 mW/°C

² Derate Linearly 1.67 mW/°C

Recommended Operating Conditions

Parameter	Symbol	Configuration	Min	Nominal	Max	Units
Load Current, Continuous	I _L	AC/DC	-	-	200	mA _{rms} / mA _{DC}
		DC-Only	-	-	350	mA _{DC}
Input Control Current	I _F	-	3	5	10	mA
Operating Temperature Range	T _A	-	-40	-	+85	°C

Electrical Characteristics @ 25°C

Parameter	Conditions	Symbol	Min	Typ	Max	Units
Output Characteristics						
Current Limit						
AC/DC Configuration	I _F =5mA, V _L =±5V, t=5ms	I _{LMT}	300	366	450	mA _P
DC Configuration			600	700	920	
On-Resistance						
AC/DC Configuration	I _F =5mA, I _L =100mA	R _{ON}	6	11	15	Ω
DC Configuration			1.5	2.8	3.75	
Off-State Leakage Current	V _L =200V	I _{LEAK}	-	0.02	1	μA
Switching Speeds						
Turn-On	I _F =5mA, I _L =100mA	t _{on}	-	0.30	2	ms
Turn-Off		t _{off}		0.16		
Output Capacitance						
	I _F =0mA, V _L =1.0V, f=1MHz	C _O	-	205	-	pF
	I _F =0mA, V _L =50V, f=1MHz			65		
Input Characteristics						
Input Control Current to Activate	I _L =100mA	I _F	-	-	2	mA
Input Control Current to Deactivate	I _L =100mA	I _F	0.2	-	-	mA
LED Forward Voltage	I _F =10mA	V _F	1.15	1.29	1.45	V
Common Characteristics						
Input to Output Capacitance	-	C _{I/O}	-	3	-	pF

PERFORMANCE DATA*

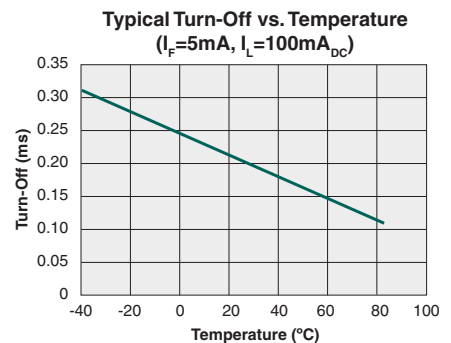
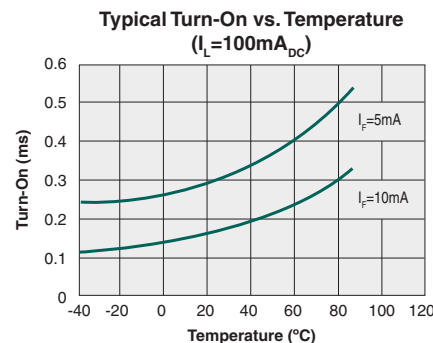
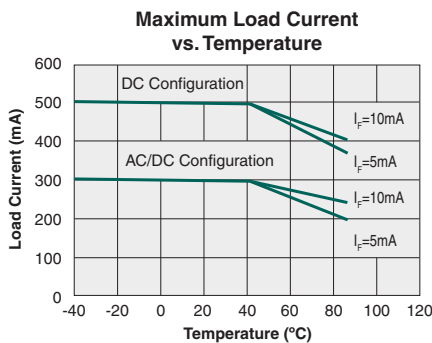
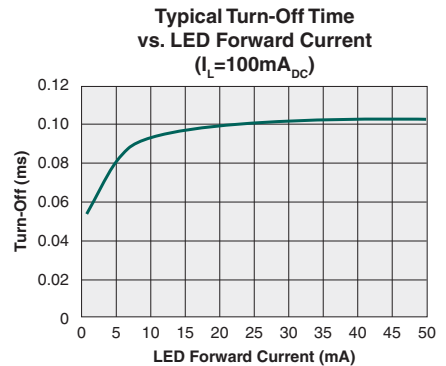
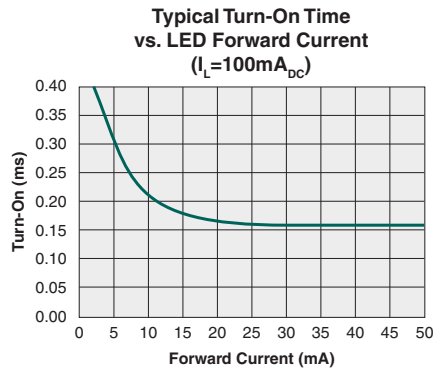
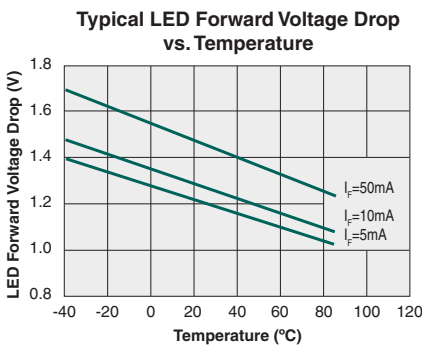
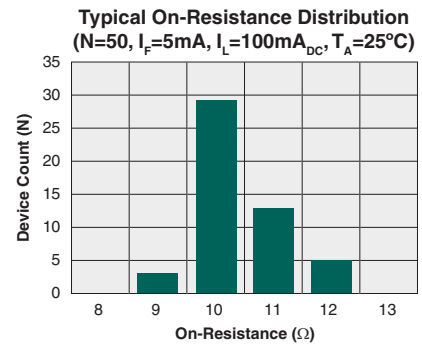
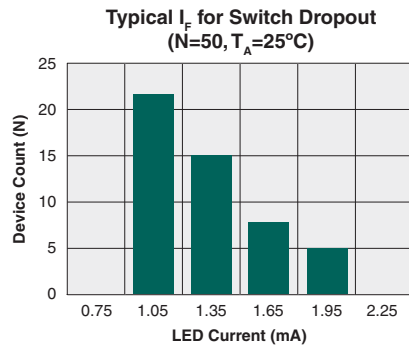
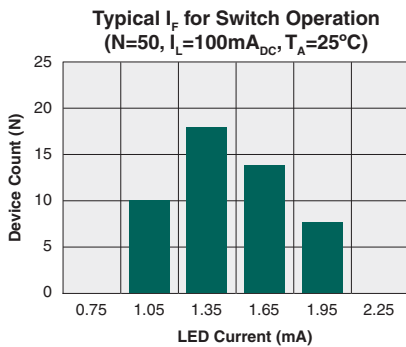
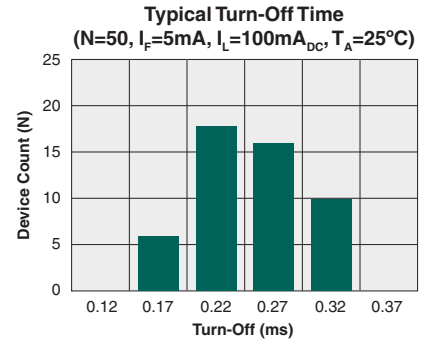
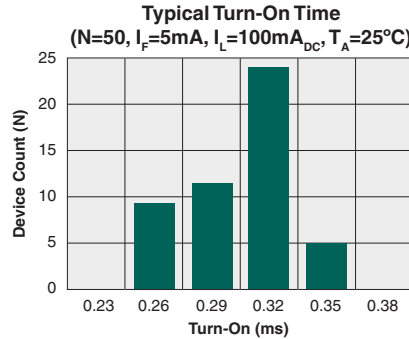
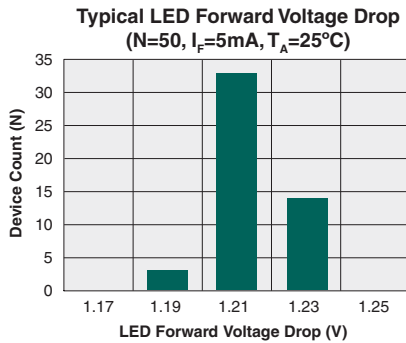

*The Performance Data shown in the graphs above is typical of device performance. For guaranteed parameters not indicated in the written specifications, please contact our application department.

PERFORMANCE DATA*

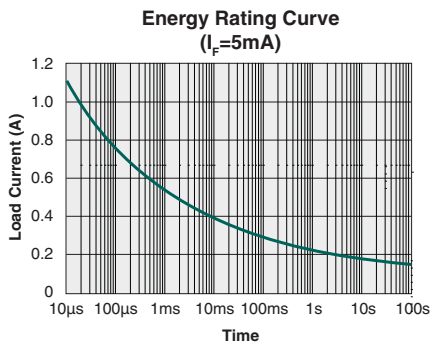
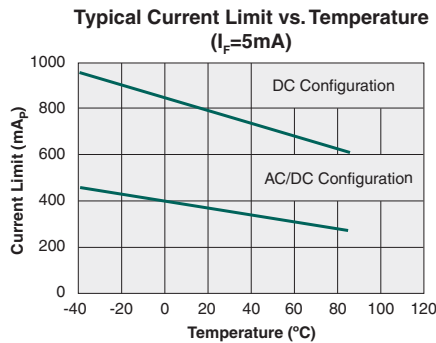
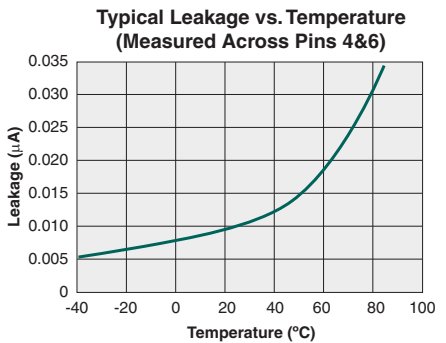
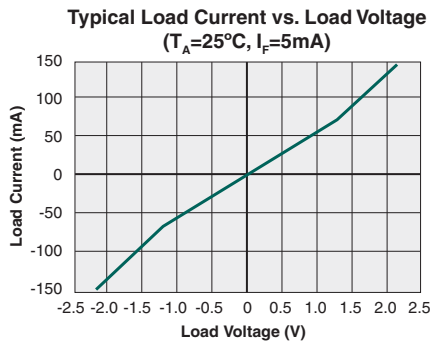
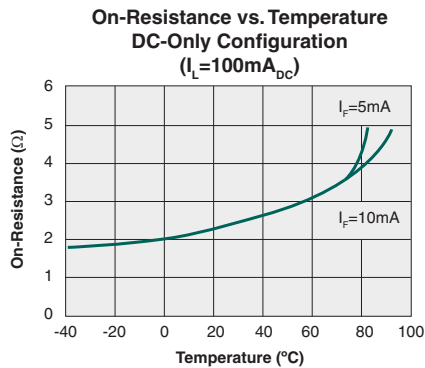
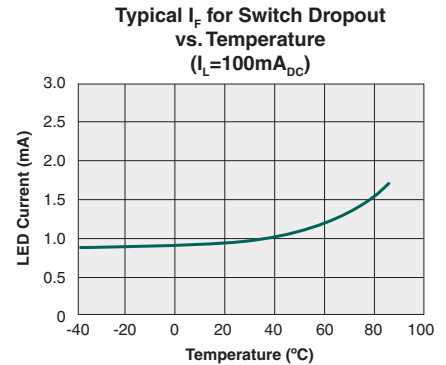
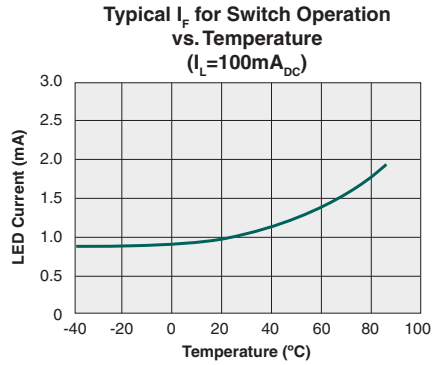
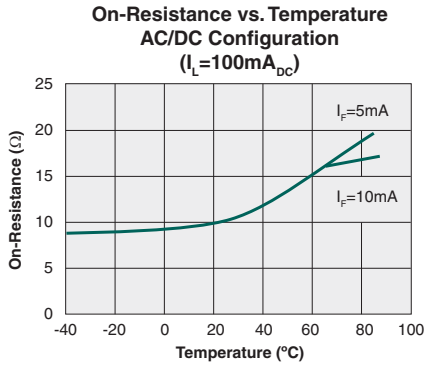

*The Performance Data shown in the graphs above is typical of device performance. For guaranteed parameters not indicated in the written specifications, please contact our application department.

Manufacturing Information

Moisture Sensitivity



All plastic encapsulated semiconductor packages are susceptible to moisture ingress. IXYS Integrated Circuits Division classified all of its plastic encapsulated devices for moisture sensitivity according to the latest version of the joint industry standard, **IPC/JEDEC J-STD-020**, in force at the time of product evaluation. We test all of our products to the maximum conditions set forth in the standard, and guarantee proper operation of our devices when handled according to the limitations and information in that standard as well as to any limitations set forth in the information or standards referenced below.

Failure to adhere to the warnings or limitations as established by the listed specifications could result in reduced product performance, reduction of operable life, and/or reduction of overall reliability.

This product carries a **Moisture Sensitivity Level (MSL) rating** as shown below, and should be handled according to the requirements of the latest version of the joint industry standard **IPC/JEDEC J-STD-033**.

Device	Moisture Sensitivity Level (MSL) Rating
CPC1510G / CPC1510GS	MSL 1

ESD Sensitivity



This product is **ESD Sensitive**, and should be handled according to the industry standard **JESD-625**.

Reflow Profile

This product has a maximum body temperature and time rating as shown below. All other guidelines of **J-STD-020** must be observed.

Device	Maximum Temperature x Time
CPC1510G / CPC1510GS	250°C for 30 seconds

Board Wash

IXYS Integrated Circuits Division recommends the use of no-clean flux formulations. However, board washing to remove flux residue is acceptable. Since IXYS Integrated Circuits Division employs the use of silicone coating as an optical waveguide in many of its optically isolated products, the use of a short drying bake could be necessary if a wash is used after solder reflow processes. Chlorine- or Fluorine-based solvents or fluxes should not be used. Cleaning methods that employ ultrasonic energy should not be used.



Mechanical Dimensions

CPC1510G

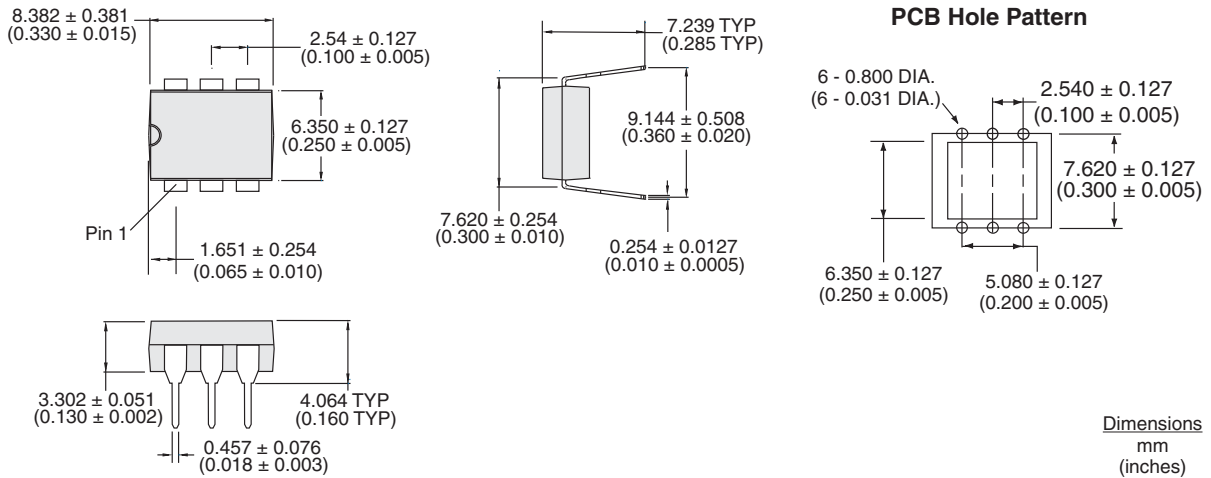

CPC1510GS

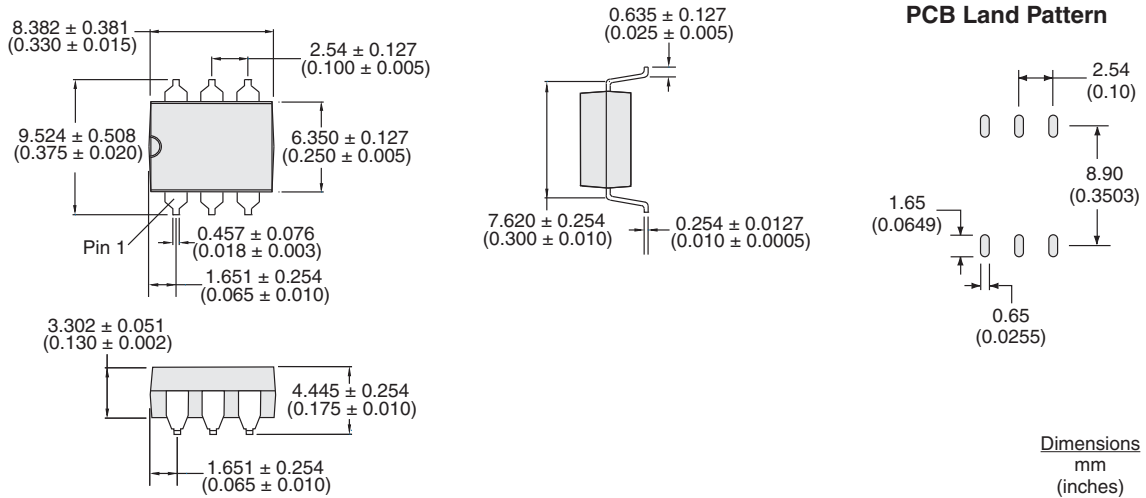

CPC1510GSTR Tape & Reel

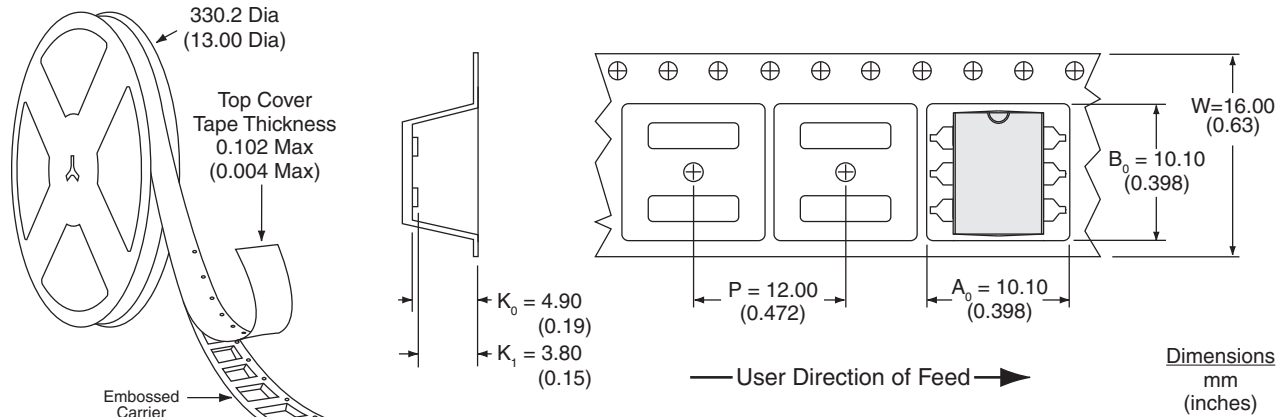

NOTES:

1. All dimensions carry tolerances of EIA Standard 481-2
2. The tape complies with all "Notes" for constant dimensions listed on page 5 of EIA-481-2

For additional information please visit our website at: www.ixysic.com

IXYS Integrated Circuits Division makes no representations or warranties with respect to the accuracy or completeness of the contents of this publication and reserves the right to make changes to specifications and product descriptions at any time without notice. Neither circuit patent licenses nor indemnity are expressed or implied. Except as set forth in IXYS Integrated Circuits Division's Standard Terms and Conditions of Sale, IXYS Integrated Circuits Division assumes no liability whatsoever, and disclaims any express or implied warranty, relating to its products including, but not limited to, the implied warranty of merchantability, fitness for a particular purpose, or infringement of any intellectual property right.

The products described in this document are not designed, intended, authorized or warranted for use as components in systems intended for surgical implant into the body, or in other applications intended to support or sustain life, or where malfunction of IXYS Integrated Circuits Division's product may result in direct physical harm, injury, or death to a person or severe property or environmental damage. IXYS Integrated Circuits Division reserves the right to discontinue or make changes to its products at any time without notice.

Specification: DS-CPC1510-R03
 ©Copyright 2012, IXYS Integrated Circuits Division
 OptoMOS® is a registered trademark of IXYS Integrated Circuits Division
 All rights reserved. Printed in USA.
 12/16/2012