

Hybrid Aluminum Electrolytic Capacitors

NSPE-T Series

- CYLINDRICAL V-CHIP CONSTRUCTION FOR SURFACE MOUNTING
- EXTENDED LOAD LIFE AT HIGH TEMPERATURE (1,500 ~ 3,000 HOURS @ +125°C)
- HIGH VOLTAGE RATINGS (25 ~ 125VDC)
- LOW ESR AND HIGH RIPPLE CURRENT RATINGS
- 6.3x6.3mm ~ 10x10.8mm CASE SIZES
- REFLOW SOLDERING RATED TO +260°C (+250°C 80V & 125V)

*Expanded
Values & 125V*

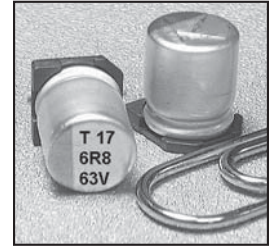

CHARACTERISTICS

Rated Voltage Range	25 ~ 125Vdc										
Rated Capacitance Range	6.8 ~ 330μF										
Operating Temp. Range	-55 ~ +125°C										
Capacitance Tolerance	±20% (M)										
Max. Leakage Current After 2 Minutes @ 20°C	Less than 0.05CV or 100μA whichever is greater										
Working and Surge Voltage Ratings	W.V. (Vdc)	25	35	40	50	63	80	100	125		
	S.V. (Vdc)	32	44	50	63	79	100	125	157		
Tan δ @ 120Hz/20°C		0.16									
Impedance Ratio	Z -55°C/Z +20°C	1 ~ 2.5									
	Z +125°C/Z +20°C	0.6 ~ 1.0									
Load Life Test @ 125°C and Rated Voltage	W.V. (Vdc)	25	35	40	50	63	80	100	125		
	Case Dia.	φ6.3mm	φ6.3X6.3 = 1,500 hrs. φ6.3X8= 2000 hrs.								
		φ8 & 10mm	3000 hrs.								
	Capacitance Change	Within ±30% of initial measured value									
	Tan δ and ESR	Less than 200% of specified max. value									
	Leakage Current	Less than specified max. value									
	ESR	Less than 200% of specified max. value									
Resistance to Soldering Heat	Hot Plate at +250°C for 30 seconds with electrodes facing downward										
	Capacitance Change	Within ±10% of the initial measured value									
	Dissipation Factor	Less than the initial limit									
	Leakage Current	Less than the initial limit									

STANDARD PRODUCTS AND CASE SIZES Dφ x L (mm)

PART NUMBER	Cap. (μF)	Working Voltage	Case Size (D X L) mm	Max. Tan δ 120Hz/20°C	Max. ESR (mΩ) AT 100kHz/20°C	Max. Ripple Current (mA rms) AT 100kHz/125°C	Load Life Hours (+125°C)
NSPE-T470M25V6.3X6.3NBF	47	25	6.3X6.3	0.16	60	890	1500
NSPE-T680M25V6.3X8NBF	68		6.3X8	0.16	45	980	2000
NSPE-T151M25V8X10.8NBF	150		8X10.8	0.16	27	1330	3000
NSPE-T271M25V10X10.8NBF	270		10X10.8	0.16	22	1520	3000
NSPE-T331M25V10X12.8NBF	330		10X12.8	0.16	16	1740	3000
NSPE-T270M35V6.3X6.3NBF	27	35	6.3X6.3	0.16	100	760	1500
NSPE-T470M35V6.3X8NBF	47		6.3X8	0.16	60	910	2000
NSPE-T101M35V8X10.8NBF	100		8X10.8	0.16	30	1260	3000
NSPE-T151M35V10X10.8NBF	150		10X10.8	0.16	23	1480	3000
NSPE-T221M35V10X12.8NBF	220		10X12.8	0.16	17	1700	3000
NSPE-T180M40V6.3X6.3NBF	18	40	6.3X6.3	0.16	110	720	1500
NSPE-T270M40V6.3X8NBF	27		6.3X8	0.16	70	870	2000
NSPE-T560M40V8X10.8NBF	56		8X10.8	0.16	32	1220	3000
NSPE-T101M40V10X10.8NBF	100		10X10.8	0.16	24	1440	3000
NSPE-T121M40V10X12.8NBF	120		10X12.8	0.16	18	1650	3000
NSPE-T100M50V6.3X6.3NBF	10	50	6.3X6.3	0.16	120	690	1500
NSPE-T150M50V6.3X8NBF	15		6.3X8	0.16	80	840	2000
NSPE-T330M50V8X10.8NBF	33		8X10.8	0.16	35	1170	3000
NSPE-T560M50V10X10.8NBF	56		10X10.8	0.16	25	1390	3000
NSPE-T820M50V10X12.8NBF	82		10X12.8	0.16	19	1590	3000

For Automotive Applications See Part Numbering System

[New Values](#)



STANDARD PRODUCTS AND CASE SIZES D ϕ x L (mm)

PART NUMBER	Cap. (μ F)	Working Voltage	Case Size (D X L) mm	Max. Tan δ 120Hz/20°C	Max. ESR (m Ω) AT 100kHz/20°C	Max. Ripple Current (mA rms) AT 100kHz/125°C	Load Life Hours (+125°C)
NSPE-T6R8M63V6.3X6.3NBF	6.8	63	6.3X6.3	0.16	150	670	1500
NSPE-T100M63V6.3X8NBF	10		6.3X8	0.16	100	740	2000
NSPE-T220M63V8X10.8NBF	22		8X10.8	0.16	40	1090	3000
NSPE-T330M63V8X10.8NBF	33		8X10.8	0.16	40	1090	3000
NSPE-T330M63V10X10.8NBF	33		10X10.8	0.16	30	1260	3000
NSPE-T470M63V10X10.8NBF	47		10X10.8	0.16	30	1260	3000
NSPE-T560M63V10X12.8NBF	56		10X12.8	0.16	22	1440	3000
NSPE-T120M80V10X10.8LBF	12	80	10X10.8	0.16	70	900	3000
NSPE-T150M80V10X10.8LBF	15		10X10.8	0.16	70	900	3000
NSPE-T180M80V10X12.8LBF	18		10X12.8	0.16	50	1100	3000
NSPE-T100M100V10X10.8LBF	10	100	10X10.8	0.16	80	870	3000
NSPE-T120M100V10X10.8LBF	12		10X10.8	0.16	80	870	3000
NSPE-T150M100V10X12.8LBF	15		10X12.8	0.16	60	1000	3000
NSPE-T100M125V10X10.8LBF	10		125	10X10.8	0.16	90	750

For Automotive Applications See Part Numbering System

New Values

RIPPLE CURRENT FREQUENCY CORRECTION FACTOR

Frequency	100Hz	1KHz	10KHz	100KHz
6.8 ~ 33 μ F	0.05	0.32	0.67	1.0
47 ~ 330 μ F	0.10	0.35	0.70	1.0

DIMENSIONS (mm)

Case Size	D ϕ \pm 0.5	L max.	A, B \pm 0.2	W	I \pm 0.2	P \pm 0.2
6.3x6.3	6.3	6.3	6.6	0.5 ~ 0.8	2.5	2.2
6.3x8	6.3	8.0	6.6	0.5 ~ 0.8	2.5	2.2
8x10.8	8.0	10.8	8.3	0.7 ~ 1.0	2.9	3.2
10x10.8	10	10.8	10.3	1.0 ~ 1.4	3.2	4.6
10x12.8	10	12.8	10.3	1.0 ~ 1.4	3.2	4.6

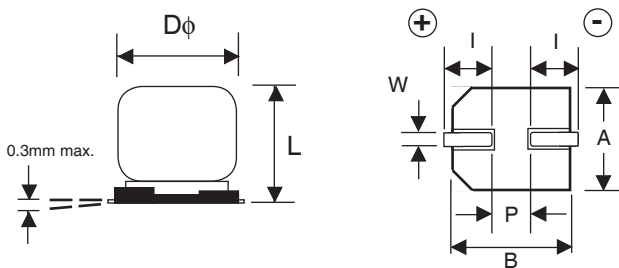

Part Marking

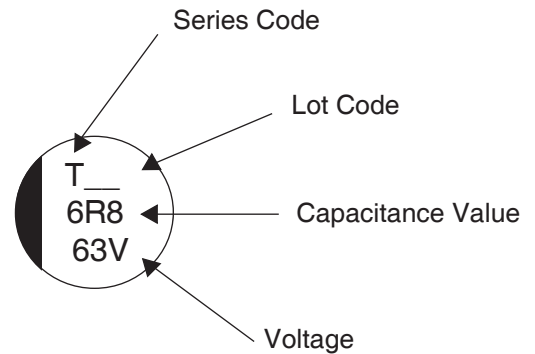

PART NUMBER SYSTEM

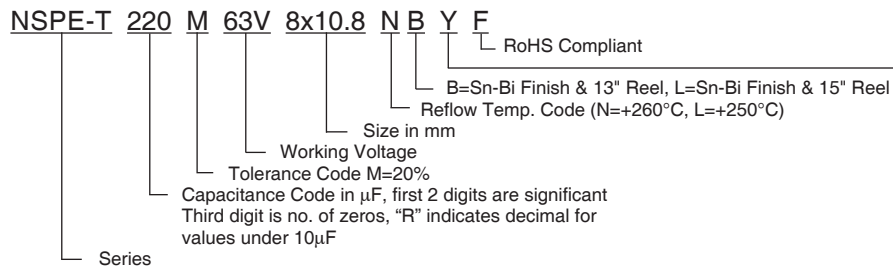

Optional: Suitable for automotive equipment, sourced to special production and inspection at TS-16949 certified production site

RECOMMENDED REFLOW SOLDERING PROFILE*

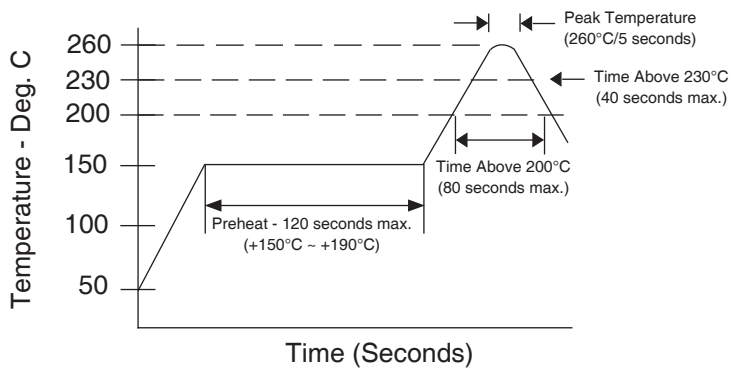

LAND PATTERN DIM. (mm)

Case Dia.	A	B	P
6.3	3.6	1.8	1.8
8	4.1	2.1	2.8
10	4.4	2.5	4.3

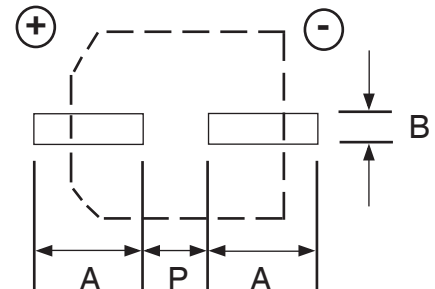

PEAK TEMPERATURE AND DURATION

Rated Voltage/Diameter	Time Above +200°C	Time Above +217°C	Time Above +230°C	Peak Temperature
25V ~ 63V / 6.3mm ~ 10mm	100 sec. max.	80 sec. max.	40 sec. max.	+260°C (5 sec. max.)
80 ~ 125V / 10mm				+250°C (5 sec. max.)

*Two reflow passes are permissible with a cool down to room temperature required between the first and second pass.

TAPING SPECIFICATIONS (mm)

- Both Leader and Trailer tape: Minimum 40mm (1.57") empty carrier tape pockets.
- Leader tape: Approximately 20cm of cover tape at leader.
- Connection: Maximum 3 connections (slices) per reel.

Case Size	A	B	C	D	P	T	t
6.3x6.3	±0.5	±0.5	±0.3	±0.1	±0.1	±0.2	max.
6.3x8	7.0	7.0	16.0	7.5	12.0	8.2	0.6
8x10.8	8.7	8.7	24.0	11.5	16.0	11.0	0.6
10x10.8	10.7	10.7	24.0	11.5	16.0	11.0	0.6
10x12.8	10.7	10.7	24.0	11.5	16.0	13.3	0.6

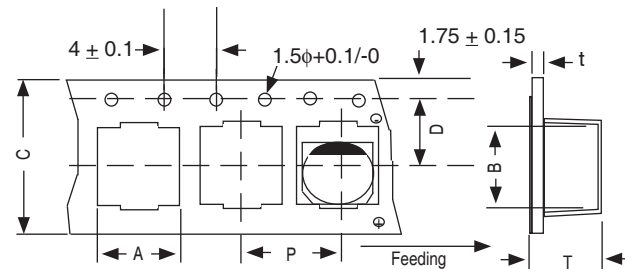

REEL DIMENSIONS (mm)

Case Size	W	Qty per Reel	
		13" (330mm)	15" (380mm)
6.3x6.3	±1.0	18	800
6.3x8	18	500	900
8x10.5	26	300	500
10x10.5	26	300	500
10x12.8	26	300	400

