



PT3612

Hi-sensitivity Hall-effect Latch

Applications

- DC brushless motors
- CAM shaft sensors
- Rotating speed measurement
- Magnetic encoders
- Automotive systems
- Home appliances
- Home safety

Features

- 3.8V to 24V wide operation voltage
- High sensitivity
- Built-in dynamic offset cancellation
- Small size
- High balance and low thermal drift magnetic sensing
- Lead length 18.7mm (UL type)

Ordering information

- PT3612-PA-T
Package(PA):UA or UL or LH
Temperature(T): A or K

Specifications

Absolute Maximum Ratings (Ta=25°C)

Parameter	Symbol	Conditions	Rating	Unit
Maximum supply voltage	V_{DDMAX}		28	V
Allowable power dissipation	P_D	TO-92(UA)	550 ^{*1}	mW
		TO-92(UL)	550 ^{*1}	mW
		SOT-23(LH)	500 ^{*1}	mW
Operating temperature range	T_A	Suffix 'A'	-40~+150	°C
		Suffix 'K'	-40~+125	°C
Storage temperature range	T_S		-55~+150	°C
Relative Humidity	R_H		20~90	%
Max. output current	I_{OMAX}		50	mA

*1: On 50mm x 50mm x 1.6mm glass epoxy board

- ◆ All PROLIFIC products described or contained herein do not have specifications that can handle applications require extremely high levels of reliability, such as life-support systems, aircraft control systems, or other applications whose failure can be reasonably expected to result in serious physical and/or material damage. Consult with your PROLIFIC representative nearest you before using any PROLIFIC products described or contained herein in such applications.
- ◆ PROLIFIC assumes no responsibility for equipment failures that result from using products at values that exceed, even momentarily, the rated values (such as maximum ratings, operating condition ranges, or other parameters) listed in products specifications of any and all PROLIFIC products described or contained herein.

P/N: PT3612-XX-X

TO92-3L (UA)

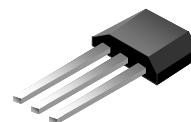

TO92-3L (UL)

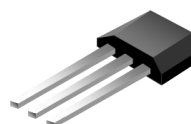

SOT23-3L (LH)

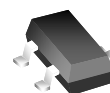

PROLIFIC TECHNOLOGY INC.

7F, No.48,Sec.3, Nan Kang Rd., Nan Kang, Taipei, 115, Taiwan.

Electrical Characteristics (T_A=+25°C, V_{DD}=12V)

Characteristic	Symbol	Test Condition	Min.	Typ.	Max.	Units
Supply Voltage	V _{DD}		3.8		24	V
Output Sink Voltage	V _{OL}	@ I _{OUT} =20mA		130	280	mV
Output Leakage Current	I _{OH}	Output switch off			0.1	uA
Output Clamp Voltage	V _{BV}			28	30	V
Supply Current	I _{DD}	Output open		4	6	mA

Magnetic Characteristics (T_A=+25°C, V_{DD}=12V)

Operate Point	B _{OP}		8	26	55	G
Release Point	B _{RP}		-55	-26	-8	G
Hysteresis	B _{HYS}		45	52	70	G

Magnetic Characteristics (T_A=-40°C~150°C, V_{DD}=5V)

Operate Point	B _{OP}		9		60	G
Release Point	B _{RP}		-60		-9	G
Hysteresis	B _{HYS}		35		72	G

Magnetic Characteristics (T_A=-40°C~150°C, V_{DD}=12V)

Operate Point	B _{OP}		9		60	G
Release Point	B _{RP}		-60		-9	G
Hysteresis	B _{HYS}		35		72	G

Output Behavior versus Polarity (T_A=-40°C~150°C, V_{DD}=3.8V~24V)

Parameters	Test Conditions(LH)	Output(LH)	Test Conditions(UA/UL)	Output(UA/UL)
South pole	B<Brp	High	B>Bop	Low
North pole	B>Bop	Low	B<Brp	High

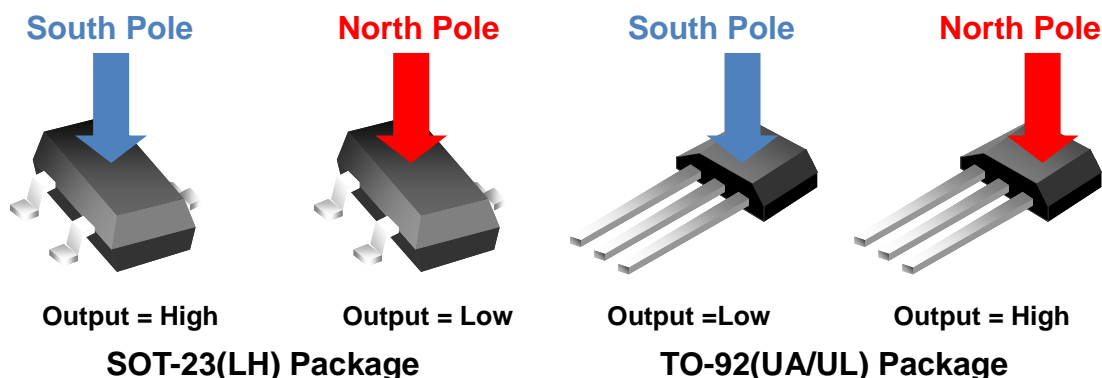

General Specifications

The PT3612 is designed for magnetic actuating using a bipolar magnetic field. The built-in dynamic offset cancellation of pre-amplifier stage achieves optimal symmetrical magnetic sensing. This Hall effect IC is optimal for DC brushless fan application. The

supply voltage range is from 3.8V to 24V and the maximum output current is 50mA.

This Hall effect sensor IC integrate the sensor, pre-amplifier with dynamic offset cancellation and the hysteresis comparator in single chip. The architecture block diagram is shown in Fig. 1.

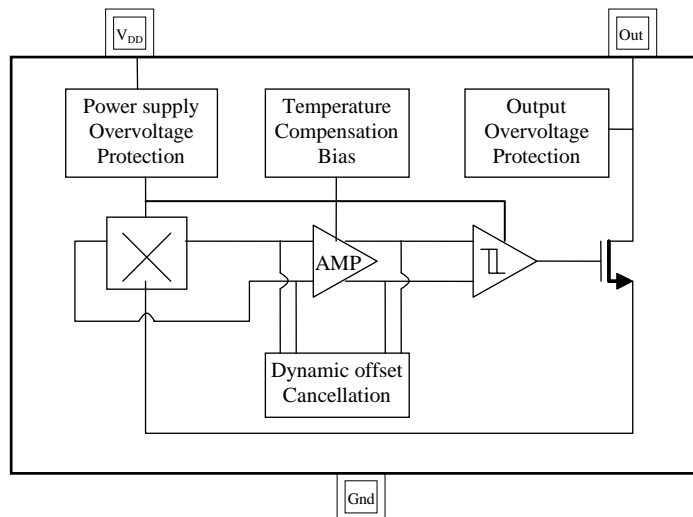
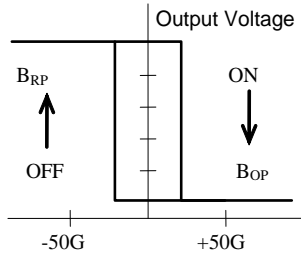
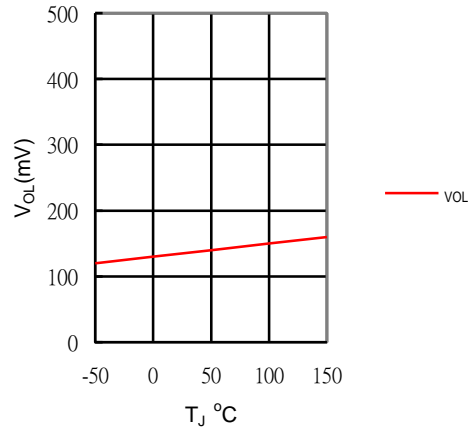

Fig. 1. Functional diagram

Magnetic Flux Density in



Output sink voltage versus temperature



B_{OP} , B_{RP} versus temperature

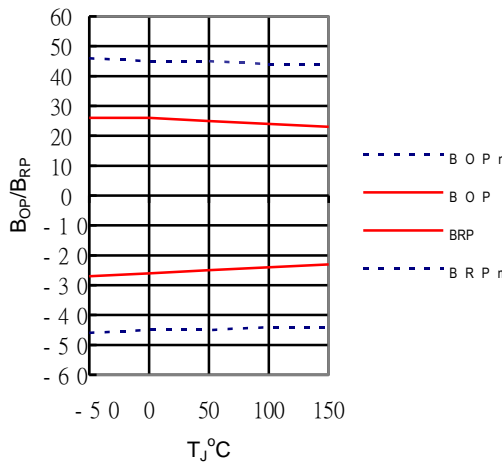

B_{OP} , B_{RP} versus supply voltage

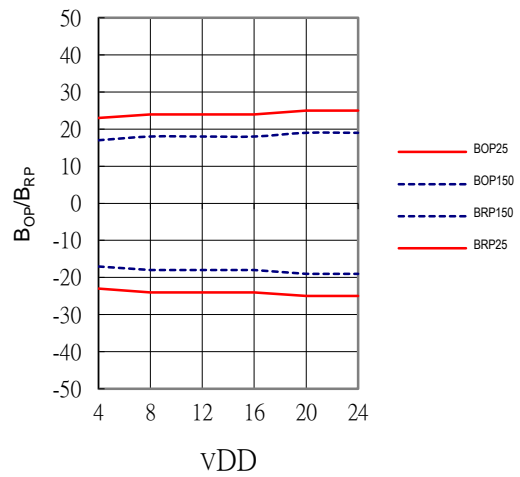

Application circuits

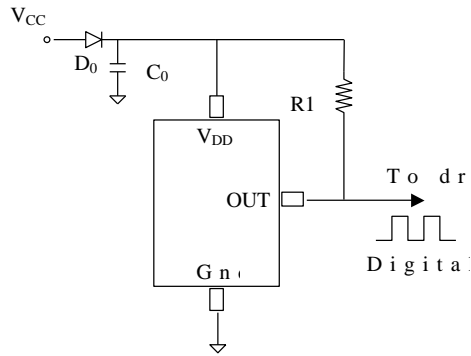

NOTE :

D0: general diode

C0: decoupling capacitor 0.1uF(recommended)

R1: 1K~10Kohm (recommended)

Package Outline TO-92(UA)

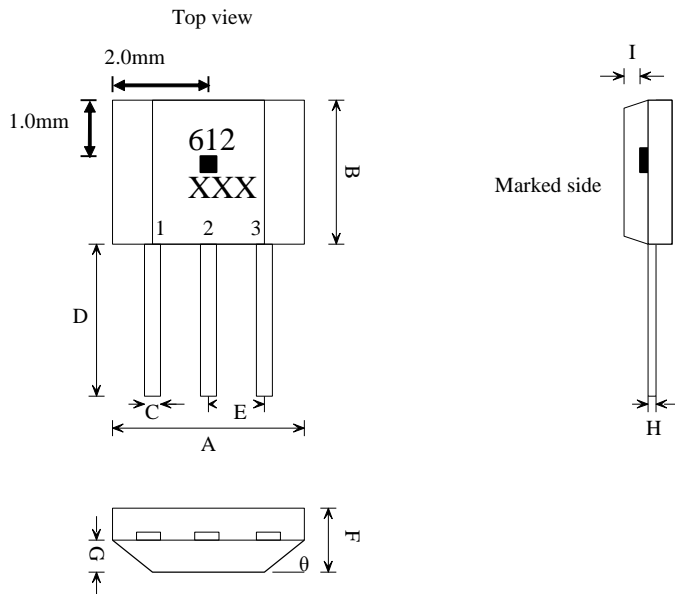

Marking:
 Part Number : 611
 Date Code : X(Year) XX(Week)

1. VDD/DC power supply
2. GND/DC ground
3. OUT/output pin

SYMBOLS	DIMENSIONS IN MILLIMETERS(mm)		
	MIN	NOM	MAX
A	3.80	4.00	4.20
B	2.90	3.10	3.30
C	0.38	0.45	0.52
D	14.40	14.60	14.80
E	1.24	1.27	1.30
F	1.45	1.50	1.55
G	0.68	0.73	0.78
H	0.36	0.43	0.50
I	0.41	0.43	0.45
θ		45°	

Package Outline
TO-92(UL)

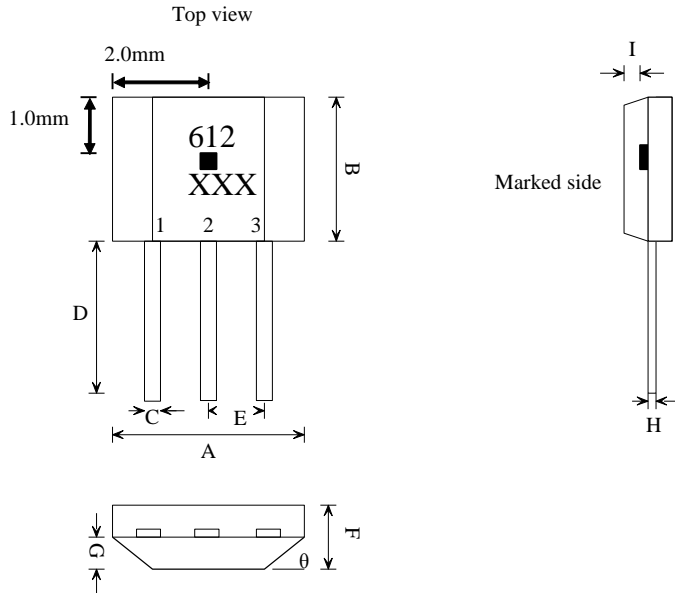

Marking:
Part Number : 612
Date Code : X(Year) XX(Week)

1. VDD/DC power supply
2. GND/DC ground
3. OUT/output pin

SYMBOLS	DIMENSIONS IN MILLIMETERS(mm)		
	MIN	NOM	MAX
A	3.80	4.00	4.20
B	2.80	3.00	3.20
C	0.33	0.40	0.47
D	18.20	18.70	19.20
E	1.24	1.27	1.30
F	1.45	1.50	1.55
G	0.68	0.73	0.78
H	0.36	0.43	0.50
I	0.33	0.40	0.47
θ		45°	

Package Outline
SOT-23(LH)

Sensor Location

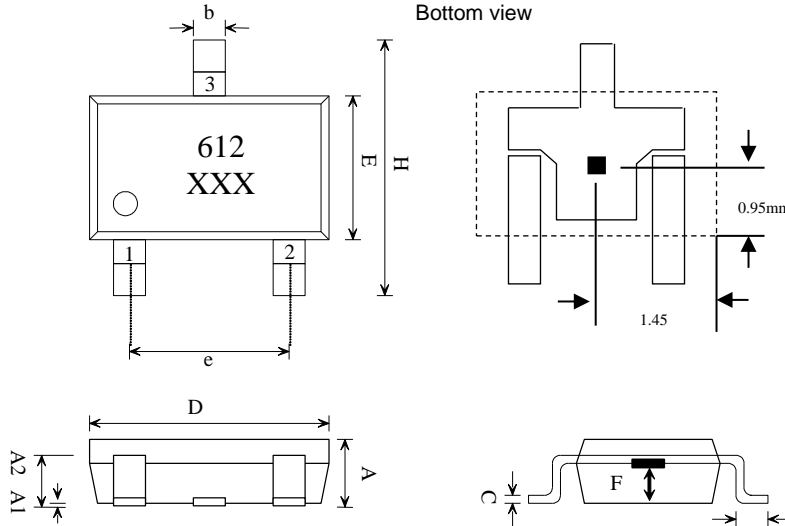

Marking:
Part Number : 612
Date Code : X(Year) XX(Week)

1. VDD/DC power supply
2. OUT/output pin
3. GND/DC ground

SYMBOLS	DIMENSIONS IN MILLIMETERS(mm)		
	MIN	NOM	MAX
A	1.00	1.10	1.30
A1	0.00	-	0.10
A2	0.70	0.80	0.90
b	0.35	0.40	0.50
C	0.10	0.15	0.25
D	2.70	2.90	3.10
E	1.40	1.80	2.00
F	0.35	0.50	0.65
H	2.60	2.8	3.00
e	1.7	1.9	2.1
L	0.20	-	-

Thermal resistance

TO92-3L

Parameter	Symbol	Conditions	Rating	Units
Allowable power dissipation	P_d		550 ^{*1}	mW
Junction to ambient thermal resistance	θ_{JA}		255	°C/W
Junction to case thermal resistance	θ_{JC}		90	°C/W
Maximum junction temperature	T_J		165	°C

*1: Reduced by 14.3mW for each increase in Ta of 1°C over 25°C When mounted on 50mm x 50mm x 1.6mm glass epoxy board

Pd versus Ambient temperature

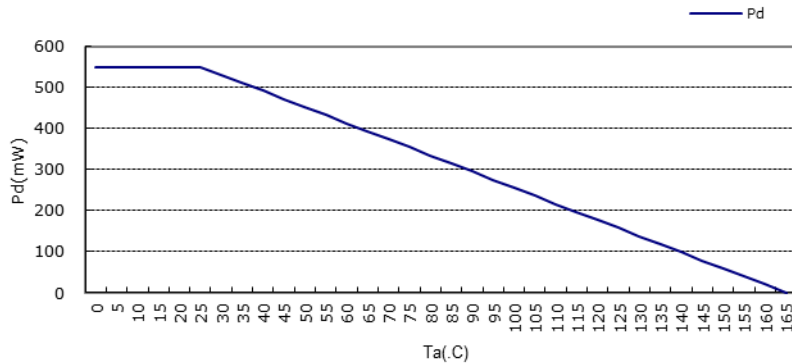

SOT-23

Parameter	Symbol	Conditions	Rating	Units
Allowable power dissipation	P_d		500 ^{*1}	mW
Junction to ambient thermal resistance	θ_{JA}		280	°C/W
Junction to case thermal resistance	θ_{JC}		110	°C/W
Maximum junction temperature	T_J		165	°C

*1: Reduced by 14.3mW for each increase in Ta of 1°C over 25°C When mounted on 50mm x 50mm x 1.6mm glass epoxy board

Pd versus Ambient temperature

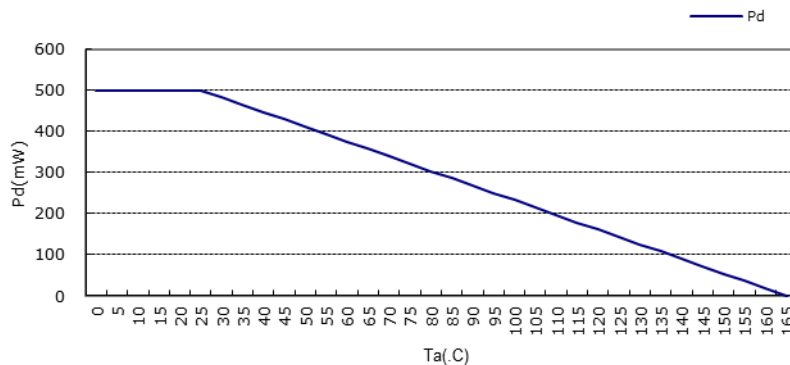

Order information

Part Number	Temperature Range	Package Type	Package Qty	Prolific Type Code
PT3612UAK	-40°C~+125°C	TO92-3L	1000pcs/Bulk	PT3612E1OAG7D1
PT3612ULK	-40°C~+125°C	TO92-3L	1000pcs/Bulk	PT3612E1RAG7D1
PT3612LHK	-40°C~+125°C	SOT23-3L	3000pcs/Reel	PT3612E1SAG8D1
PT3612UAA	-40°C~+150°C	TO92-3L	1000pcs/Bulk	PT3612E1OAG7D2
PT3612ULA	-40°C~+150°C	TO92-3L	1000pcs/Bulk	PT3612E1RAG7D2
PT3612LHA	-40°C~+150°C	SOT23-3L	3000pcs/Reel	PT3612E1SAG8D2

- ◆ Specifications of any and all PROLIFIC products described or contained herein stipulate the performance, characteristics, and functions of the described products in the independent state, and are not guarantees of the performance, characteristics, and functions of the described products as mounted in the customer's products or equipment. To verify symptoms and states that cannot be evaluated in an independent device, the customer should always evaluate and test devices mounted in the customer's products or equipment.
- ◆ PROLIFIC Technology Inc. strives to supply high-quality high-reliability products. However, any and all semiconductor products fail with some probability. It is possible that these probabilistic failures could give rise to accidents or events that could endanger human lives, that could give rise to smoke or fire, or that could cause damage to other property. When designing equipment, adopt safety measures so that these kinds of accidents or events cannot occur. Such measures include but are not limited to protective circuits and error prevention circuits for safe design, redundant design, and structural design.
- ◆ In the event that any and all PROLIFIC products described or contained herein fall under strategic products (including services) controlled under the Foreign Exchange and Foreign Trade Control Law of Taiwan, such products must not be exported with our obtaining export license from the Ministry of international Trade and Industry in accordance with the above law.
- ◆ No part of this publication may be reproduced or transmitted in any form or by any means, electronic or mechanical, including photocopying and recording, or any information storage or retrieval system, or otherwise, without the prior written permission of PROLIFIC Technology Inc.
- ◆ Any and all information described or contained herein are subject to change without notice due to product/technology improvement, etc. When designing equipment, refer to the Delivery Specification for the PROLIFIC product that you intend to use.
- ◆ Information (including circuit diagrams and circuit parameters) herein is for example only; it is not guaranteed for volume production. PROLIFIC believes information herein is accurate and reliable, but no guarantees are made or implied regarding its use or any infringements of intellectual property rights or other rights of third parties.

Specifications and information herein are subject to change without notice.