

SS400F and SS400G Series

Temperature Compensated, Hall-Effect Position Sensors



DESCRIPTION

The SS400F and SS400G Series sensors are small, versatile digital Hall-effect devices that are operated by the magnetic field from a permanent magnet or an electromagnet, and are designed to respond to alternating North and South poles or to a South pole only. Bipolar, latching and unipolar magnetics are available.

Band gap regulation provides stable operation over 3.8 Vdc to 30 Vdc supply voltage range. These sensors are capable of continuous 20 mA sinking output and may be cycled as high as 50 mA max. Its 3.8 V capability allows for use in many potential low voltage applications.

FEATURES

- Temperature-compensated magnetics
- Miniature plastic package
- Low voltage: 3.8 V operation

The digital collector sinking output voltage is easily interfaced with a wide variety of electronic circuits.

To provide reliable products and consistent quality, the SS400F Series (catalog listings ending with F) are 100% factory tested at 25 °C [77 °F] and the SS400G Series (catalog listings ending with G) are 100% factory tested at 125 °C [302 °F]. Both series are qualified for operation up to 150 °C [302 °F].

Minimum order requirement is 100,000 units or more (bulk package has 1000 units per bag).

POTENTIAL APPLICATIONS

Transportation:

- Speed and RPM (revolutions per minute) sensing
- Tachometer, counter pickup
- Motor and fan control
- Electric window lift
- Convertible roof position
- Automotive transmission position

Industrial:

- Speed and RPM (revolutions per minute) sensing
- Tachometer, counter pickup
- Flow-rate sensing
- Brushless dc (direct current) motor commutation
- Motor and fan control
- Robotics control

Medical:

- Motor assemblies
- Medication dispense control

SS400F and SS400G Series

Table 1. Operating Characteristics (over operating voltage and temperature, unless otherwise noted)

Characteristic	Min.	Typ.	Max.	Note
Supply voltage	3.8	-	30	Vdc
Current consumption	-	-	10	mA
Supply current (operated @ 25°C, Vs = 5V)	-	6.5	-	mA
Output voltage (operated)	-	-	0.40	sinking 20 mA max.
Output current (operated)	-	-	20 mA	-
Output leakage current (released)	-	-	10 µA	-
Output switching time	-	-	-	V _{cc} = 12 V,
rise, 10% to 90%	-	0.05 µs	1.5 µs	RL = 1.6 kΩ,
fall, 90% to 10%	-	0.15 µs	1.5 µs	CL = 20 pF

Table 2. Output Current Absolute Limits

Supply Voltage	Output Current
-1 Vdc to 24 Vdc	50 mA max.
24 Vdc to 25 Vdc	37 mA max.
25 Vdc to 26 Vdc	33 mA max.
26 Vdc to 27 Vdc	28 mA max.
27 Vdc to 28 Vdc	24 mA max.
28 Vdc to 29 Vdc	19 mA max.
29 Vdc to 30 Vdc	15 mA max.

Table 3. Absolute Maximum Ratings

Supply voltage	-1 Vdc to +30 Vdc	NOTICE Absolute maximum ratings are the extreme limits that the device will withstand without damage to the device. However, the electrical and mechanical characteristics are not guaranteed as the maximum limits (above recommended operating conditions) are approached, nor will the device necessarily operate at absolute maximum ratings.	
Voltage externally applied to output	+30 Vdc max. (OFF only) -0.5 Vdc min. (OFF or ON)		
Output ON current	see Table 2		
Operating temperature	-40 °C to 150 °C [-40 °F to 302 °F]		
Storage temperature	-65 °C to 160 °C [-85 °F to 320 °F]		
Magnetic flux	No limit. Circuit cannot be damaged by magnetic overdrive.		

Table 4. Magnetic Characteristics (Factory Tested at 25 °C for F and 125 °C for G.)

Temperature	Operating Characteristic	SS411G	SS413F SS413G	SS441G	SS443F SS443G	SS449G	SS461G	SS466G
		Bipolar	Bipolar	Unipolar	Unipolar	Unipolar	Latching	Latching
-40 °C [-40 °F]	min. op.	NS	NS	50 G	110 G	285 G	5 G	100 G
	max. op.	70 G	140 G	135 G	215 G	435 G	110 G	200 G
	min. rel.	-70 G	-140 G	20 G	80 G	210 G	-110 G	-200 G
	max. rel.	NS	NS	120 G	190 G	360 G	-5 G	-100 G
	min. dif.	15 G	20 G	15 G	25 G	30 G	50 G	200 G
0 °C [32 °F]	min. op.	NS	NS	53 G	110 G	305 G	5 G	100 G
	max. op.	65 G	140 G	117 G	190 G	400 G	90 G	185 G
	min. rel.	-65 G	-140 G	20 G	80 G	230 G	-90 G	-185 G
	max. rel.	NS	NS	99 G	165 G	325 G	-5 G	-100 G
	min. dif.	15 G	20 G	15 G	25 G	30 G	50 G	200 G
25 °C [77 °F]	min. op.	NS	NS	55 G	110 G	310 G	10 G	100 G
	max. op.	60 G	140 G	115 G	180 G	390 G	85 G	180 G
	min. rel.	-60 G	-140 G	20 G	75 G	235 G	-85 G	-180 G
	max. rel.	NS	NS	95 G	155 G	31 G	-10 G	-100 G
	min. dif.	15 G	20 G	20 G	25 G	30 G	50 G	200 G
85 °C [185 °F]	min. op.	NS	NS	45 G	90 G	290 G	110 G	95 G
	max. op.	60 G	140 G	120 G	180 G	400 G	85 G	180 G
	min. rel.	-60 G	-140 G	15 G	70 G	215 G	-85 G	-180 G
	max. rel.	NS	NS	105 G	165 G	325 G	-10 G	-95 G
	min. dif.	12 G	20 G	15 G	15 G	30 G	50 G	190 G
125 °C [257 °F]	min. op.	NS	NS	40 G	80 G	270 G	5 G	80 G
	max. op.	65 G	140 G	123 G	190 G	410 G	100 G	180 G
	min. rel.	-65 G	-140 G	15 G	60 G	200 G	-100 G	-180 G
	max. rel.	NS	NS	115 G	180 G	340 G	-5 G	-80 G
	min. dif.	12 G	20 G	8 G	10 G	30 G	50 G	160 G
150 °C [302 °F]	min. op.	NS	NS	35 G	65 G	260 G	5 G	70 G
	max. op.	70 G	140 G	125 G	200 G	420 G	110 G	185 G
	min. rel.	-70 G	-140 G	10 G	55 G	185 G	-110 G	-185 G
	max. rel.	NS	NS	120 G	195 G	345 G	-5 G	-70 G
	min. dif.	10 G	20 G	5 G	5 G	30 G	50 G	140 G

NOTICE

Bipolar Hall-effect sensors may have an initial output in either the ON or OFF state if powered up with an applied magnetic field in the differential zone (applied magnetic field >Brp and <Bop). Honeywell recommends allowing 10 µs for output voltage to stabilize after supply voltage has reached 5 V.

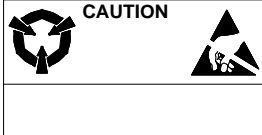
Temperature Compensated, Hall-Effect Position Sensors

Figure 1. Performance Charts and Block Diagram

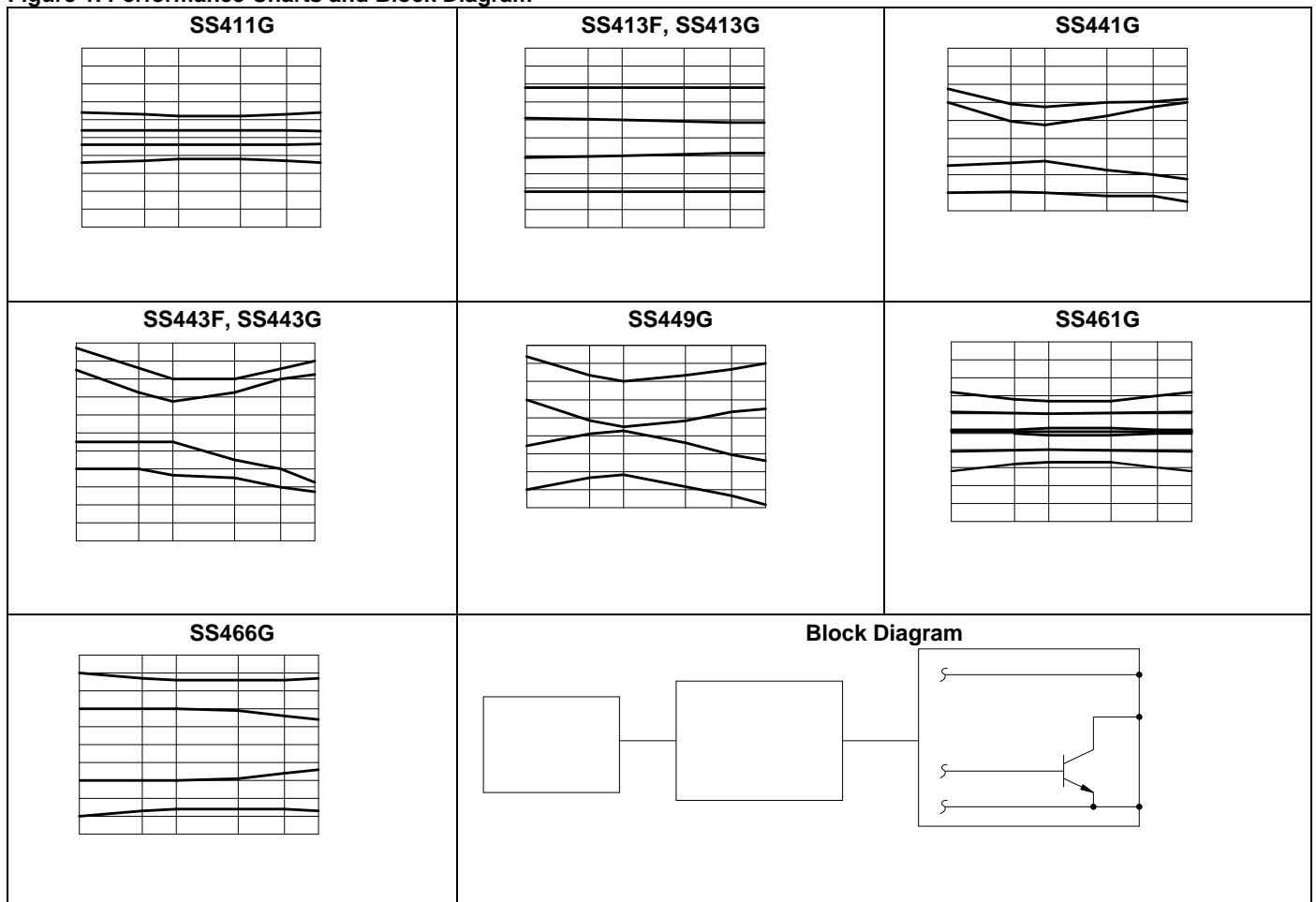
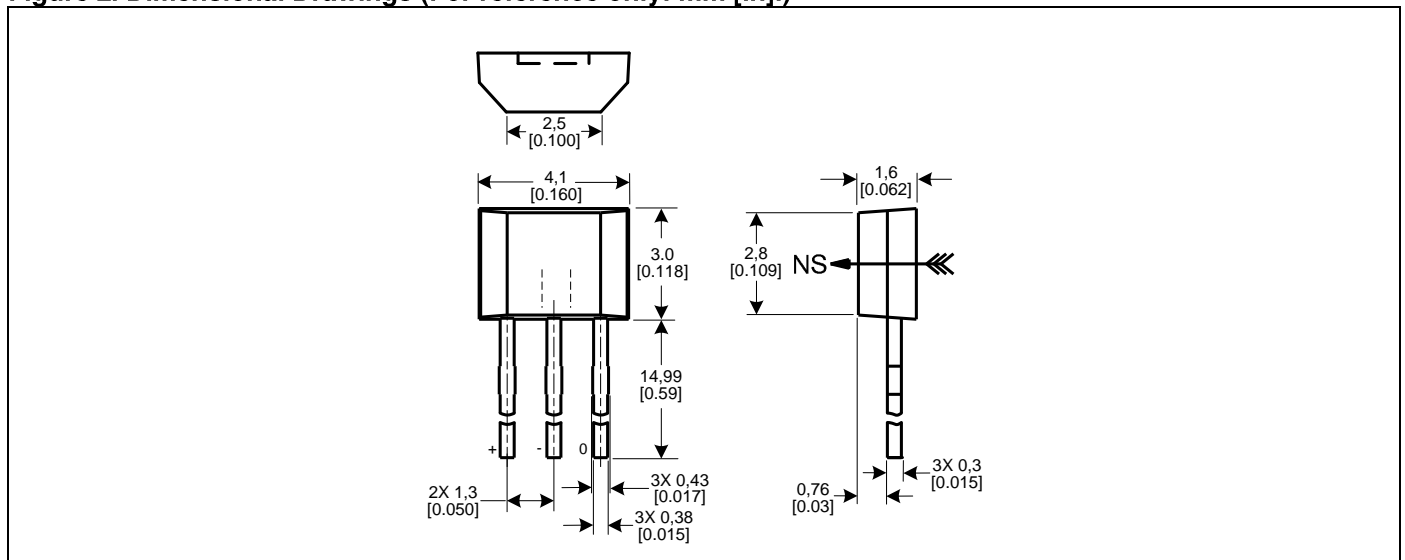
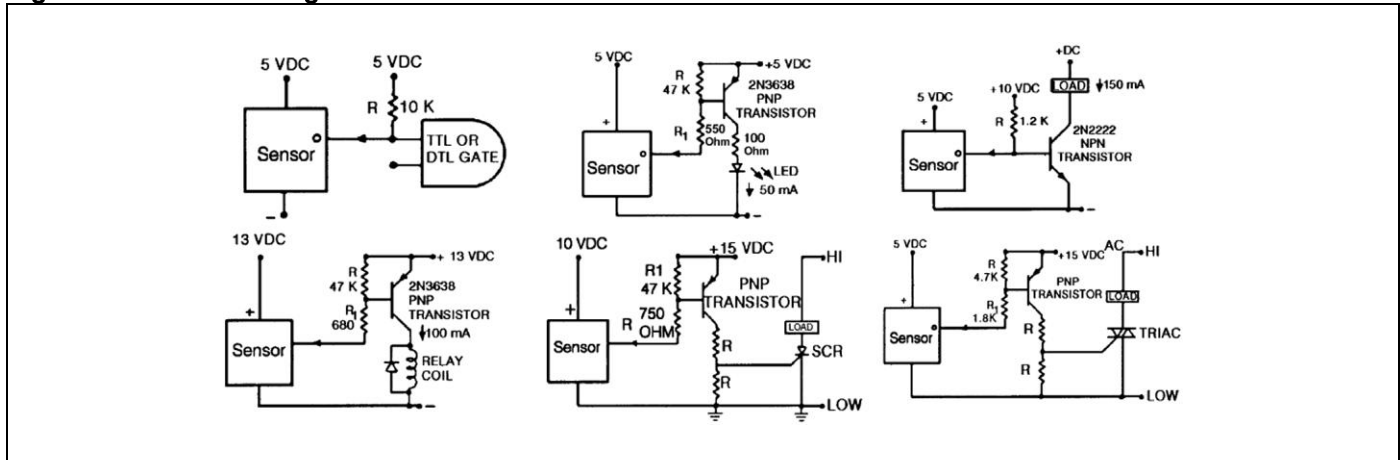

Figure 2. Dimensional Drawings (For reference only: mm [in].)



SS400F and SS400G Series

Figure 3. Electronic Diagrams



SS400F Series Order Guide

Catalog Listing	Description
SS413F	Temperature compensated, Hall-effect position sensor, factory tested at 25 °C [77 °F], bipolar magnetics, medium Gauss operating characteristics (see Table 4)
SS443F	Temperature compensated, Hall-effect position sensor, factory tested at 25 °C [77 °F], unipolar magnetics, medium Gauss operating characteristics (see Table 4)

SS400G Series Order Guide

Catalog Listing	Description
SS411G	Temperature compensated, Hall-effect position sensor, factory tested at 125 °C [302 °F], bipolar magnetics, low Gauss operating characteristics (see Table 4)
SS413G	Temperature compensated, Hall-effect position sensor, factory tested at 125 °C [302 °F], bipolar magnetics, medium Gauss operating characteristics (see Table 4)
SS441G	Temperature compensated, Hall-effect position sensor factory tested at 125 °C [302 °F], unipolar magnetics, low Gauss operating characteristics (see Table 4)
SS443G	Temperature compensated, Hall-effect position sensor, factory tested at 125 °C [302 °F], unipolar magnetics, medium Gauss operating characteristics (see Table 4)
SS449G	Temperature compensated, Hall-effect position sensor, factory tested at 125 °C [302 °F], unipolar magnetics, high Gauss operating characteristics (see Table 4)
SS461G	Temperature compensated, Hall-effect position sensor, factory tested at 125 °C [302 °F], latching magnetics, low Gauss operating characteristics (see Table 4)
SS466G	Temperature compensated, Hall-effect position sensor, factory tested at 125 °C [302 °F], latching magnetics, medium Gauss operating characteristics (see Table 4)

This page was intentionally left blank.

WARNING

PERSONAL INJURY

DO NOT USE these products as safety or emergency stop devices or in any other application where failure of the product could result in personal injury.

Failure to comply with these instructions could result in death or serious injury.

WARRANTY/REMEDY

Honeywell's standard product warranty applies unless agreed to otherwise by Honeywell in writing; please refer to your order acknowledgement or consult your local sales office for specific warranty details. If warranted goods are returned to Honeywell during the period of coverage, Honeywell will repair or replace, at its option, without charge those items it finds defective. **The foregoing is buyer's sole remedy and is in lieu of all other warranties, expressed or implied, including those of merchantability and fitness for a particular purpose. In no event shall Honeywell be liable for consequential, special, or indirect damages.**

While we provide application assistance personally, through our literature and the Honeywell web site, it is up to the customer to determine the suitability of the product in the application.

Specifications may change without notice. The information we supply is believed to be accurate and reliable as of this printing. However, we assume no responsibility for its use.

WARNING

MISUSE OF DOCUMENTATION

- The information presented in this product sheet is for reference only. Do not use this document as a product installation guide.
- Complete installation, operation, and maintenance information is provided in the instructions supplied with each product.

Failure to comply with these instructions could result in death or serious injury.

SALES AND SERVICE

Honeywell serves its customers through a worldwide network of sales offices, representatives and distributors. For application assistance, current specifications, pricing or name of the nearest Authorized Distributor, contact your local sales office or:

E-mail: info.sc@honeywell.com

Internet: www.honeywell.com/sensing

Phone and Fax:

Asia Pacific	+65 6355-2828; +65 6445-3033 Fax
Europe	+44 (0) 1698 481481; +44 (0) 1698 481676 Fax
Latin America	+1-305-805-8188; +1-305-883-8257 Fax
USA/Canada	+1-800-537-6945; +1-815-235-6847 +1-815-235-6545 Fax

Sensing and Control
Honeywell
1985 Douglas Drive North
Golden Valley, Minnesota 55422
www.honeywell.com/sensing

005900-1-EN IL50 GLO Printed in USA
July 2009
Copyright © 2009 Honeywell International Inc. All rights reserved.

Honeywell

Mouser Electronics

Authorized Distributor

Click to View Pricing, Inventory, Delivery & Lifecycle Information:

[Honeywell:](#)

[SS413F](#)