

---

## 150mA LDO REGULATOR

---

NO.EA-105-111027

### OUTLINE

The R1180x Series are CMOS-based voltage regulator ICs with high output voltage accuracy, extremely low supply current, and low ON-resistance. Each of these ICs consists of a voltage reference unit, an error amplifier, resistor-net for voltage setting, a current limit circuit which prevents the destruction by excess current, and so on. The output voltage of these ICs is fixed with high accuracy. B version has a chip enable pin, therefore ultra-low consumption current standby mode can be realized with the pin.

Since the packages for these ICs are SOT-23-5 (R1180N Series), SC-82AB (R1180Q Series), and SON1612-6 (R1180D Series), therefore high density mounting of the ICs on boards is possible.

### FEATURES

- Supply Current ..... Typ. 1 $\mu$ A  
(Except the current through CE pull-down circuit)
- Standby Mode ..... Typ. 0.1 $\mu$ A
- Dropout Voltage ..... Typ. 0.25V ( $I_{OUT}=150\text{mA}$  3.0V Output type)
- Temperature-Drift Coefficient of Output Voltage ..... Typ.  $\pm 100\text{ppm}/^{\circ}\text{C}$
- Line Regulation ..... Typ. 0.05%/V
- Output Voltage Accuracy .....  $\pm 2.0\%$
- Packages ..... SON1612-6, SC-82AB, SOT-23-5
- Output Voltage Range ..... 1.2V to 3.6V (0.1V steps)  
(For other voltages, please refer to MARK INFORMATION.)
- Built-in Fold Back Protection Circuit ..... Typ. 40mA (Current at short mode)
- Ceramic capacitors are recommended to be used with this IC ..... 0.1 $\mu$ F

### APPLICATIONS

- Stable voltage reference.
- Power source for electrical appliances such as cameras, VCRs and camcorders.
- Power source for battery-powered equipment.

## BLOCK DIAGRAMS

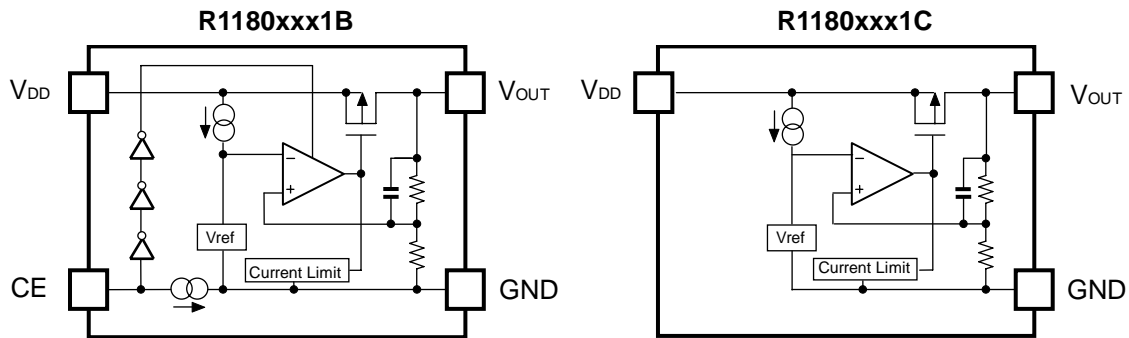

## SELECTION GUIDE

The output voltage, CE pin polarity, package, etc. for the ICs can be selected at the user's request.

Product Name	Package	Quantity per Reel	Pb Free	Halogen Free
R1180Dxx1*-TR-FE	SON1612-6	4,000 pcs	Yes	Yes
R1180Qxx1*-TR-FE	SC-82AB	3,000 pcs	Yes	Yes
R1180Nxx1*-TR-FE	SOT-23-5	3,000 pcs	Yes	Yes

xx: The output voltage can be designated in the range from 1.2V(12) to 3.6V(36) in 0.1V steps.  
(For other voltages, please refer to MARK INFORMATIONS.)

\* : CE pin polarity are options as follows.  
(B) "H" Active  
(C) without CE pin

## PIN CONFIGURATION

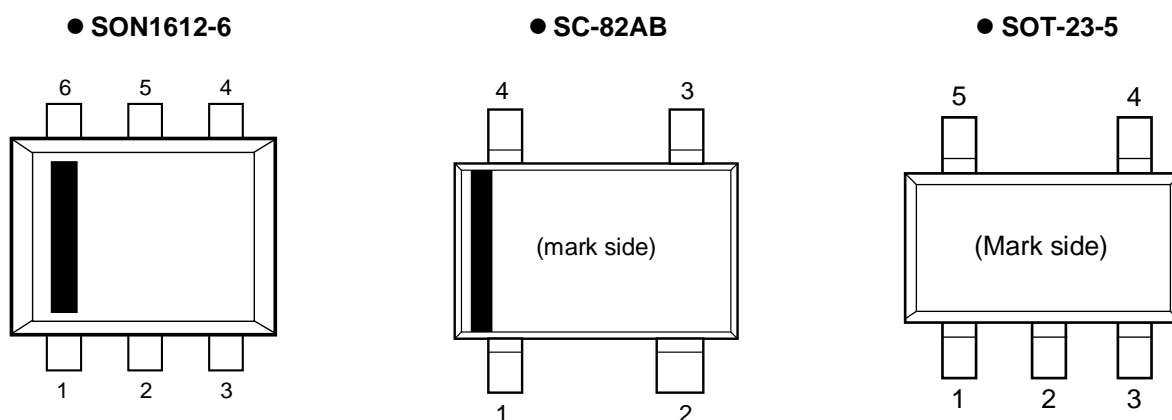

## PIN DESCRIPTIONS

### • SON1612-6

Pin No	Symbol	Pin Description
1	$V_{DD}$	Input Pin
2	GND	Ground Pin
3	$V_{OUT}$	Output pin
4	NC	No Connection
5	GND	Ground Pin
6	CE or NC	Chip Enable Pin or No Connection

### • SC-82AB

Pin No	Symbol	Pin Description
1	CE or NC	Chip Enable Pin or No Connection
2	GND	Ground Pin
3	$V_{OUT}$	Output pin
4	$V_{DD}$	Input Pin

### • SOT-23-5

Pin No	Symbol	Pin Description
1	$V_{DD}$	Input Pin
2	GND	Ground Pin
3	CE or NC	Chip Enable Pin or No Connection
4	NC	No Connection
5	$V_{OUT}$	Output pin

## ABSOLUTE MAXIMUM RATINGS

Symbol	Item	Rating	Unit
$V_{IN}$	Input Voltage	6.5	V
$V_{CE}$	Input Voltage (CE Pin)	6.5	V
$V_{OUT}$	Output Voltage	-0.3 to $V_{IN}+0.3$	V
$I_{OUT}$	Output Current	180	mA
$P_D$	Power Dissipation (SON1612-6)*	500	mW
	Power Dissipation (SC-82AB)*	380	
	Power Dissipation (SOT-23-5)*	420	
$T_{opt}$	Operating Temperature Range	-40 to 85	°C
$T_{stg}$	Storage Temperature Range	-55 to 125	°C

\*) For Power Dissipation, please refer to PACKAGE INFORMATION.

### ABSOLUTE MAXIMUM RATINGS

Electronic and mechanical stress momentarily exceeded absolute maximum ratings may cause the permanent damages and may degrade the life time and safety for both device and system using the device in the field.

The functional operation at or over these absolute maximum ratings is not assured.

### RECOMMENDED OPERATING CONDITIONS (ELECTRICAL CHARACTERISTICS)

All of electronic equipment should be designed that the mounted semiconductor devices operate within the recommended operating conditions. The semiconductor devices cannot operate normally over the recommended operating conditions, even if when they are used over such conditions by momentary electronic noise or surge. And the semiconductor devices may receive serious damage when they continue to operate over the recommended operating conditions.

## ELECTRICAL CHARACTERISTICS

### • R1180xxx1B/C

T<sub>opt</sub>=25°C

Symbol	Item	Conditions	Min.	Typ.	Max.	Unit
V <sub>OUT</sub>	Output Voltage	V <sub>IN</sub> =Set V <sub>OUT</sub> +1V 1μA ≤ I <sub>OUT</sub> ≤ 30mA	×0.980		×1.020	V
I <sub>OUT</sub>	Output Current	V <sub>IN</sub> -V <sub>OUT</sub> =1.0V(V <sub>OUT</sub> ≥ 1.5V) V <sub>IN</sub> =2.4V(V <sub>OUT</sub> <1.5V)	150			mA
ΔV <sub>OUT</sub> /ΔI <sub>OUT</sub>	Load Regulation	V <sub>IN</sub> -V <sub>OUT</sub> =1.0V(V <sub>OUT</sub> ≥ 1.5V) V <sub>IN</sub> =2.4V(V <sub>OUT</sub> <1.5V) 1μA ≤ I <sub>OUT</sub> ≤ 150mA		20	40	mV
V <sub>DIF</sub>	Dropout Voltage	Refer to the ELECTRICAL CHARACTERISTICS by OUTPUT VOLTAGE				
I <sub>SS</sub>	Supply Current	V <sub>IN</sub> -V <sub>OUT</sub> =1.0V, I <sub>OUT</sub> =0mA		1.0	1.5	μA
I <sub>standby</sub>	Supply Current (Standby)	V <sub>IN</sub> -V <sub>OUT</sub> =1.0V, V <sub>CE</sub> =GND		0.1	1.0	μA
ΔV <sub>OUT</sub> /ΔV <sub>IN</sub>	Line Regulation	I <sub>OUT</sub> =30mA V <sub>OUT</sub> +0.5V ≤ V <sub>IN</sub> ≤ 6.0V (V <sub>OUT</sub> ≥ 1.5V) 2.0V ≤ V <sub>IN</sub> ≤ 6.0V (1.2V ≤ V <sub>OUT</sub> ≤ 1.4V)		0.05	0.20	%/V
V <sub>IN</sub>	Input Voltage		1.7		6.0	V
ΔV <sub>OUT</sub> /ΔT <sub>opt</sub>	Output Voltage Temperature Coefficient	I <sub>OUT</sub> =30mA -40°C ≤ T <sub>opt</sub> ≤ 85°C		±100		ppm/°C
I <sub>SC</sub>	Short Current Limit	V <sub>OUT</sub> =0V		40		mA
I <sub>PD</sub>	CE Pull-down Constant Current	(R1180xxx1B)		0.35		μA
V <sub>CEH</sub>	CE Input Voltage "H"	(R1180xxx1B)	1.2		6.0	V
V <sub>CEL</sub>	CE Input Voltage "L"	(R1180xxx1B)	0.0		0.3	V

### • ELECTRICAL CHARACTERISTICS by OUTPUT VOLTAGE

T<sub>opt</sub> = 25°C

Output Voltage V <sub>OUT</sub> (V)	Dropout Voltage V <sub>DIF</sub> (V)		
	Condition	Typ.	Max.
1.2 ≤ V <sub>OUT</sub> < 1.3	I <sub>OUT</sub> =150mA	0.85	1.20
1.3 ≤ V <sub>OUT</sub> < 1.4		0.75	1.10
1.4 ≤ V <sub>OUT</sub> < 1.5		0.65	1.00
1.5 ≤ V <sub>OUT</sub> < 1.7		0.60	0.90
1.7 ≤ V <sub>OUT</sub> < 1.9		0.50	0.75
1.9 ≤ V <sub>OUT</sub> < 2.1		0.40	0.65
2.1 ≤ V <sub>OUT</sub> < 2.8		0.35	0.55
2.8 ≤ V <sub>OUT</sub> ≤ 3.6		0.25	0.40

## TYPICAL APPLICATION

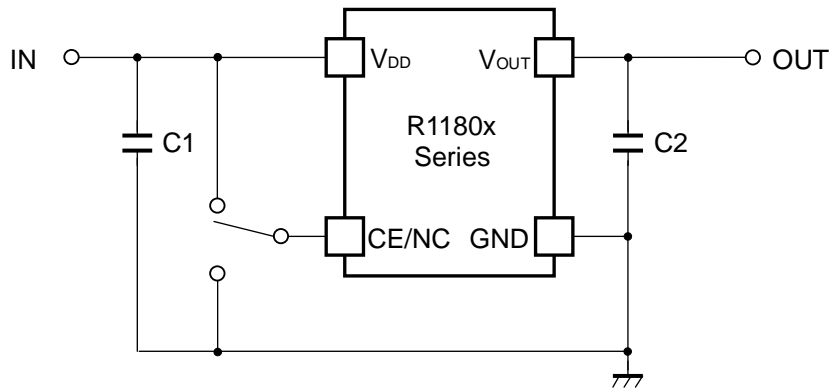

(External Components)

Output Capacitor

Ceramic Capacitor      0.1 $\mu$ F

## TECHNICAL NOTES

When using these ICs, consider the following points:

### Phase Compensation

In these ICs, phase compensation is made for securing stable operation even if the load current is varied. For this purpose, use a capacitor C2 with good frequency characteristics and ESR (Equivalent Series Resistance). (Note: If additional ceramic capacitors are connected with parallel to the output pin with an output capacitor for phase compensation, the operation might be unstable. Because of this, test these ICs with as same external components as ones to be used on the PCB.)

### PCB Layout

Make V<sub>DD</sub> and GND lines sufficient. If their impedance is high, noise pickup or unstable operation may result. Connect a capacitor C1 with a capacitance value as much as 0.1 $\mu$ F or more between V<sub>DD</sub> and GND pin, and as close as possible to the pins.

Set external components, especially the output capacitor C2, as close as possible to the ICs, and make wiring as short as possible.

## TEST CIRCUITS

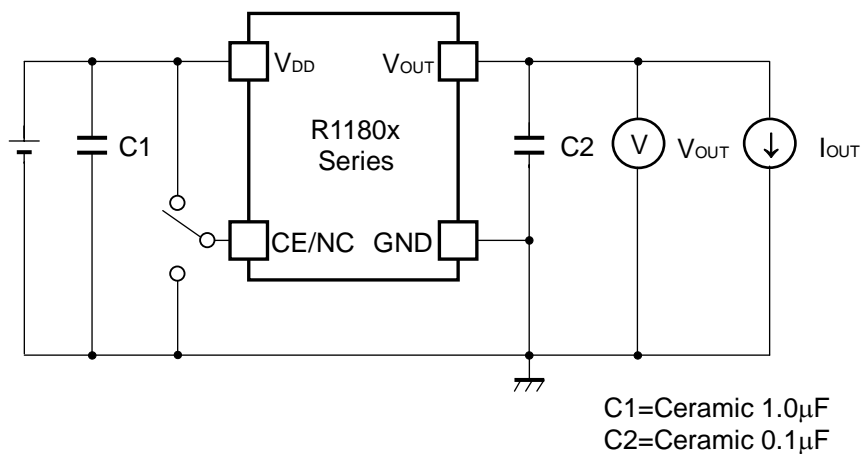

Standard test Circuit

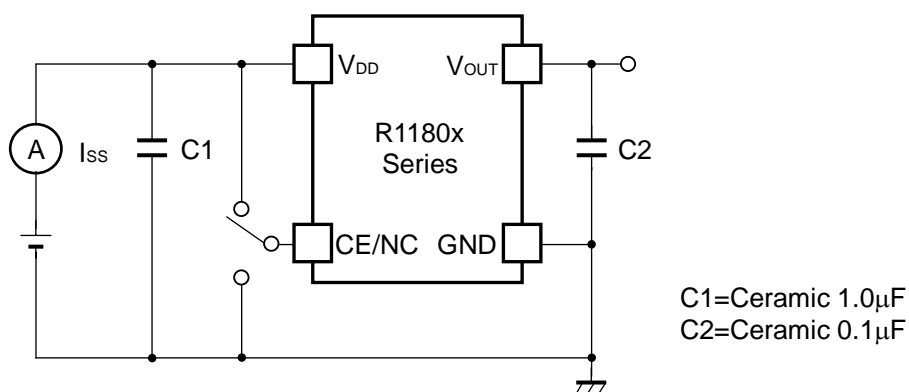

Supply Current Test Circuit

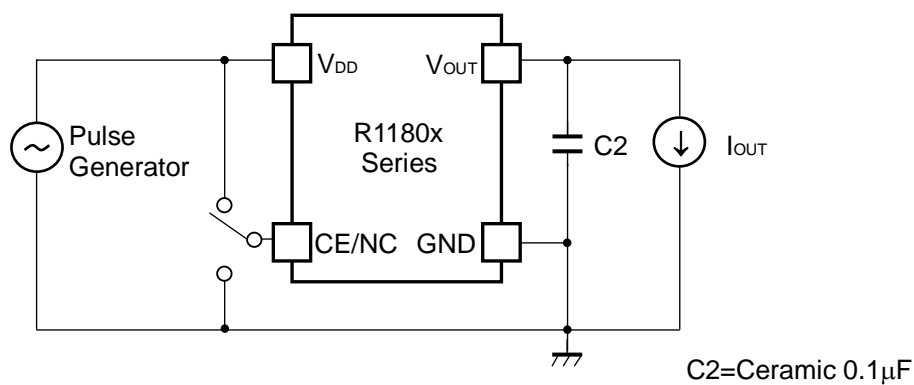

Ripple Rejection, Line Transient Response Test Circuit

## TYPICAL CHARACTERISTICS

### 1) Output Voltage vs. Output Current (T<sub>opt</sub>=25°C)

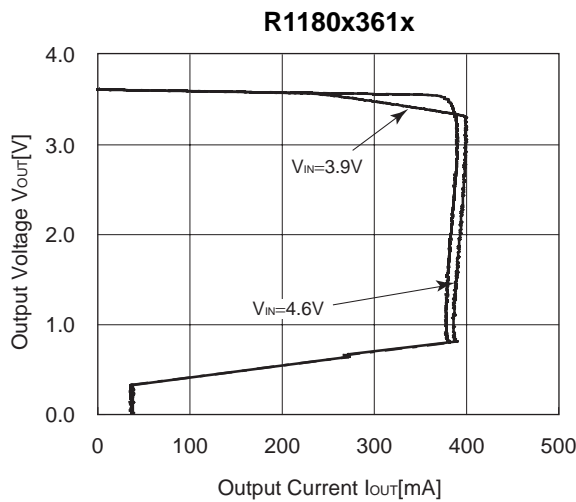
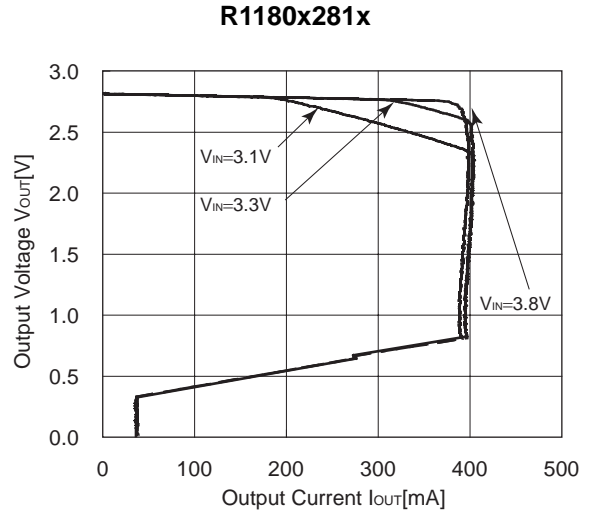
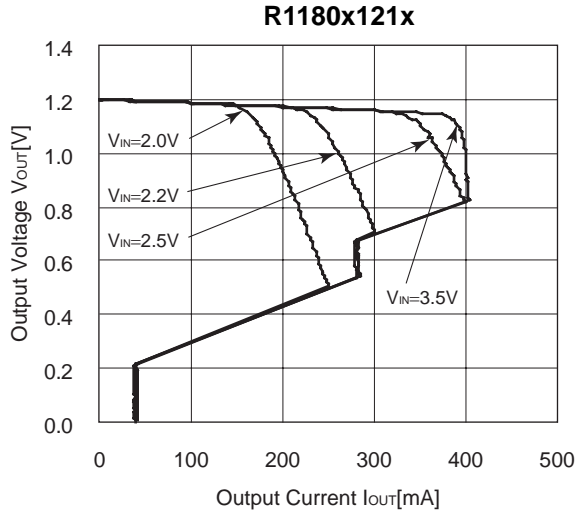

### 2) Output Voltage vs. Input Voltage (T<sub>opt</sub>=25°C)

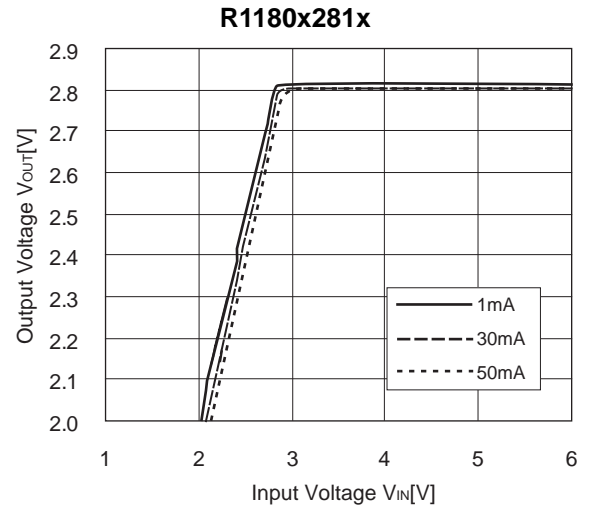
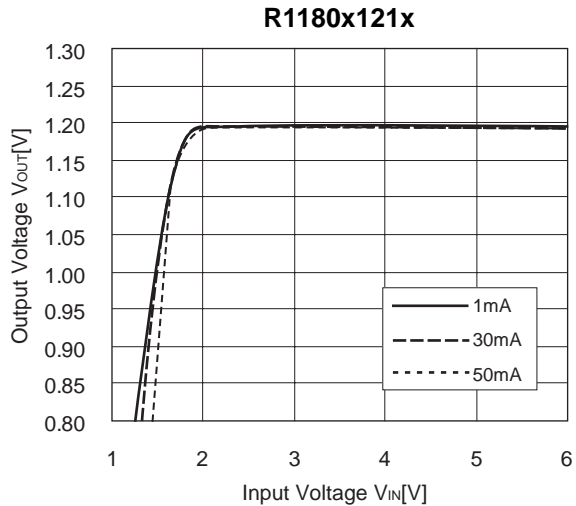



**R1180x361x**

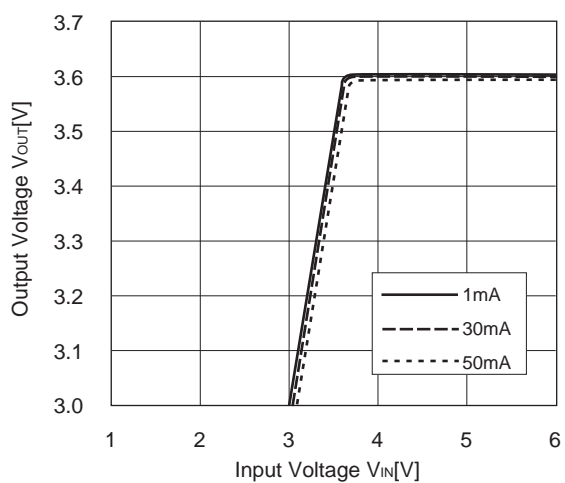

3) Dropout Voltage vs. Output Current

**R1180x121x**

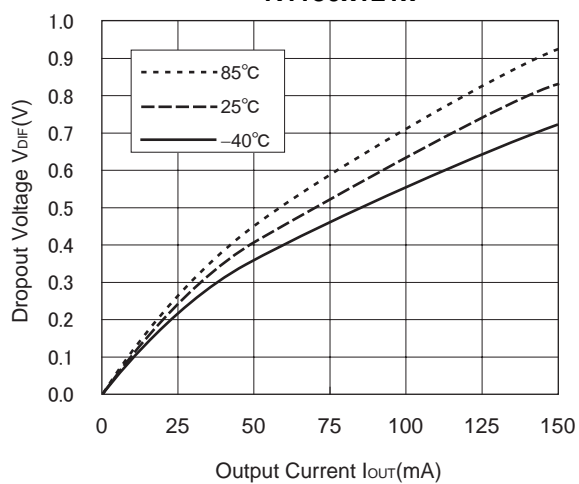

**R1180x281x**

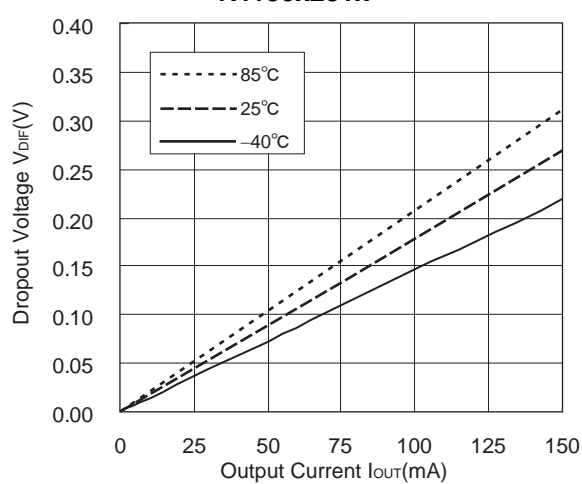

**R1180x361x**

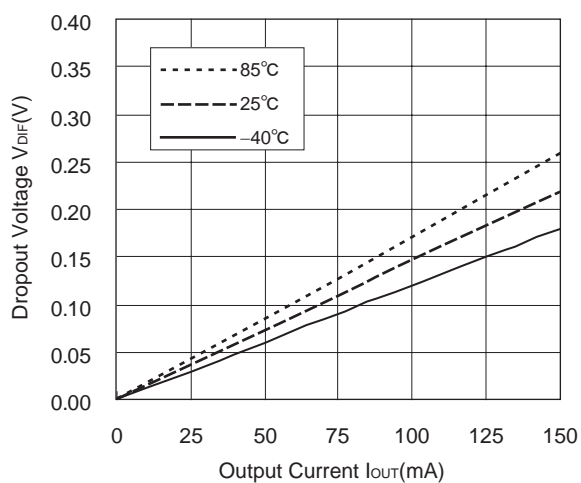

# R1180x

## 4) Output Voltage vs. Temperature ( $I_{OUT}=30mA$ )

### R1180x121x ( $V_{IN}=2.2V$ )

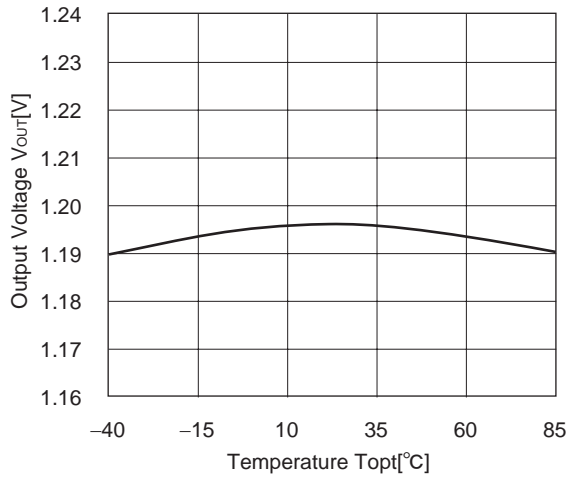

### R1180x281x ( $V_{IN}=3.8V$ )

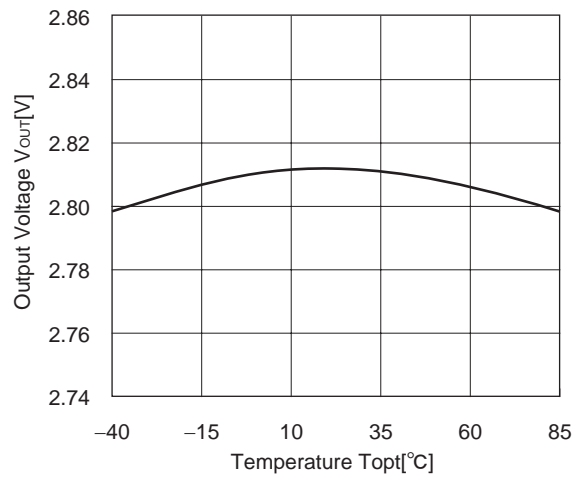

### R1180x361x ( $V_{IN}=4.6V$ )

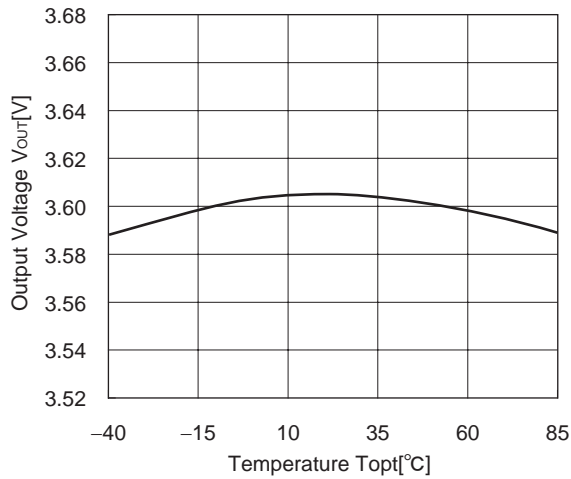

## 5) Supply Current vs. Input Voltage ( $T_{opt}=25^{\circ}C$ )

### R1180x121x

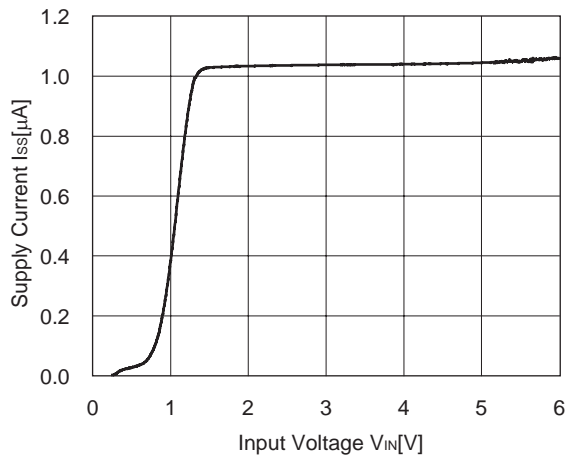

### R1180x281x

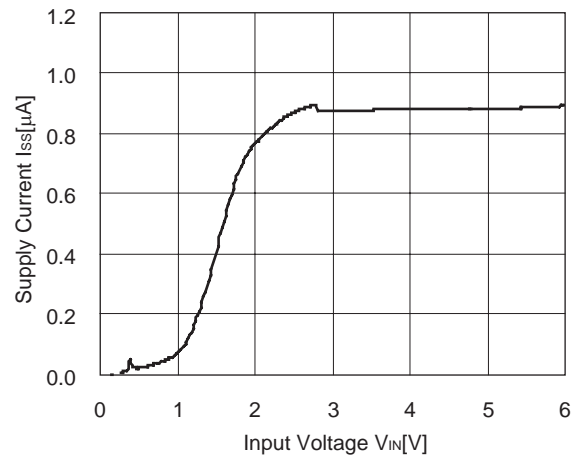

R1180x361x

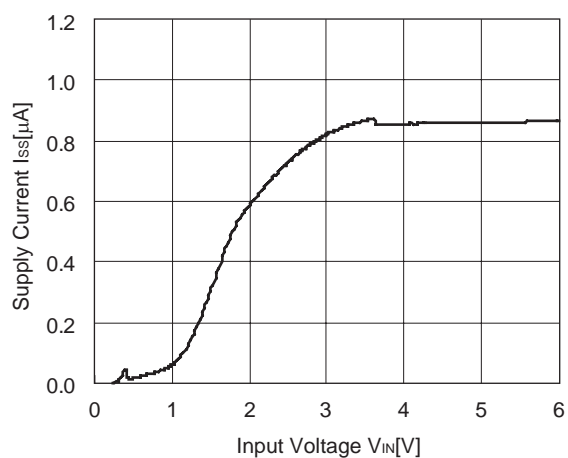

## 6) Supply Current vs. Temperature

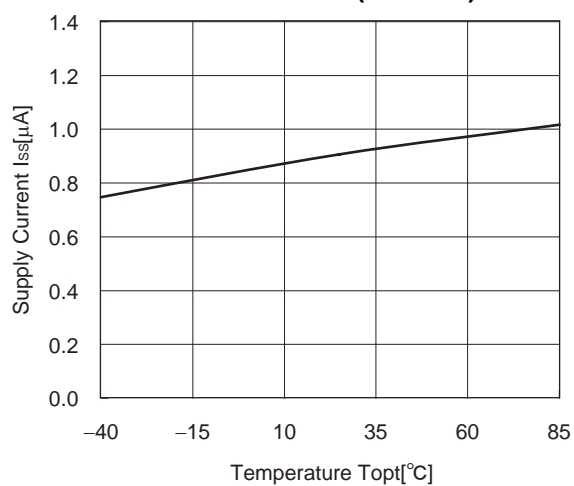
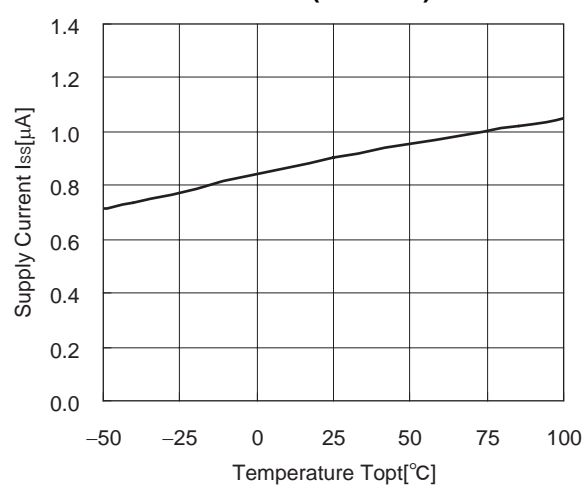
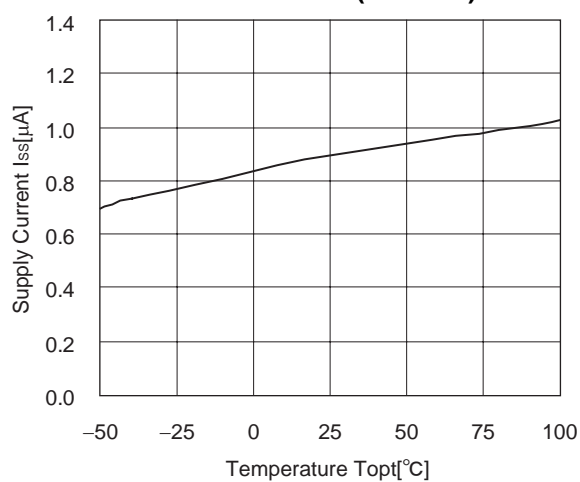
R1180x121x( $V_{IN}=2.2V$ )R1180x281x( $V_{IN}=3.8V$ )R1180x361x( $V_{IN}=4.6V$ )

# R1180x

## 7) Dropout Voltage vs. Set Output Voltage (T<sub>opt</sub>=25°C)

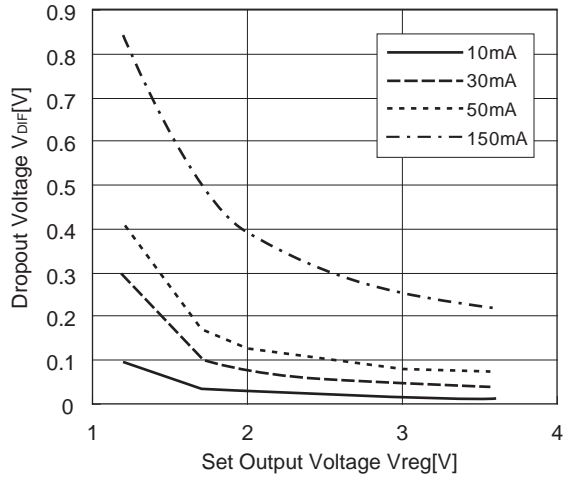

## 8) Ripple Rejection vs. Frequency (C<sub>IN</sub>=none)

### R1180x121x

$V_{IN}=2.4V_{DC}+0.5p-p$   
 $C_{OUT}=\text{Ceramic}0.1\mu F$

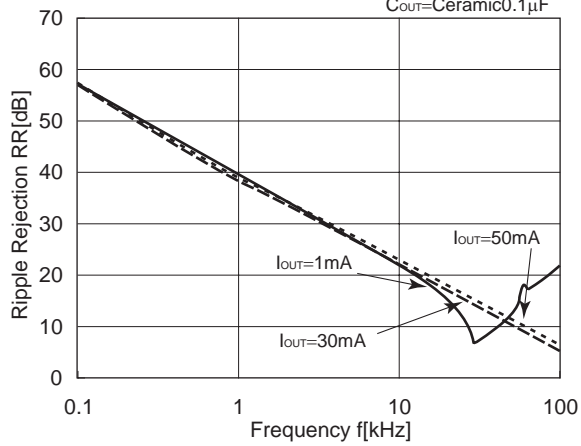

### R1180x121x

$V_{IN}=2.4V_{DC}+0.5p-p$   
 $C_{OUT}=\text{Ceramic}1\mu F$

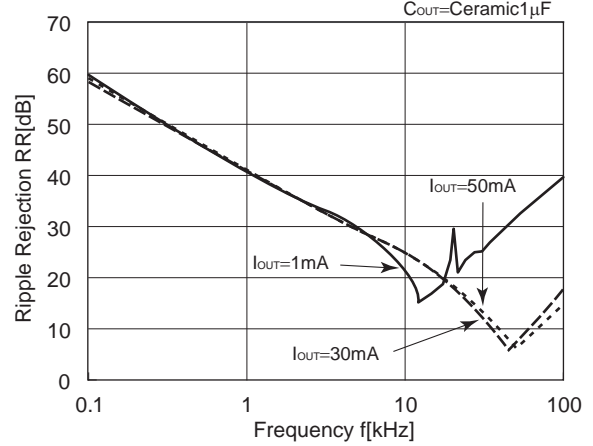

### R1180x281x

$V_{IN}=3.8V_{DC}+0.5p-p$   
 $C_{OUT}=\text{Ceramic}0.1\mu F$

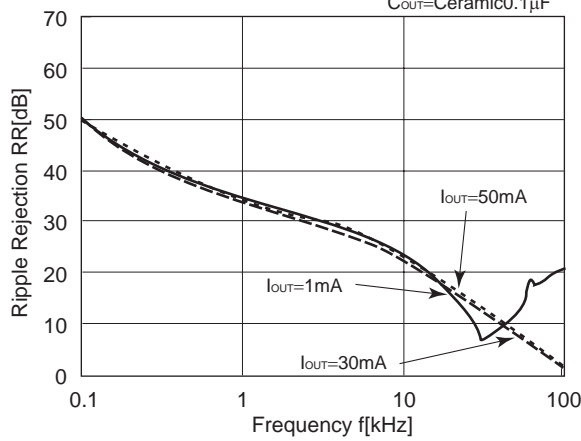

### R1180x281x

$V_{IN}=3.8V_{DC}+0.5p-p$   
 $C_{OUT}=\text{Ceramic}1\mu F$

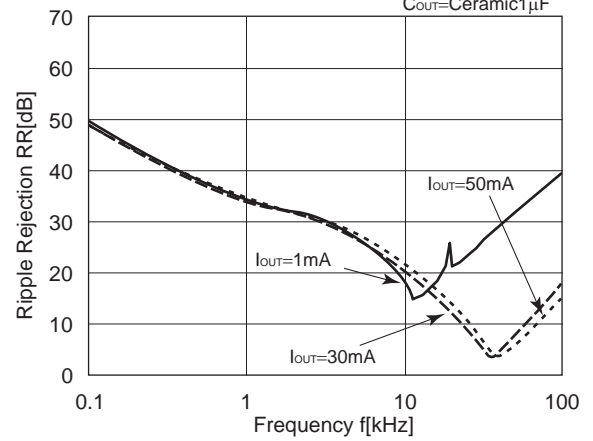

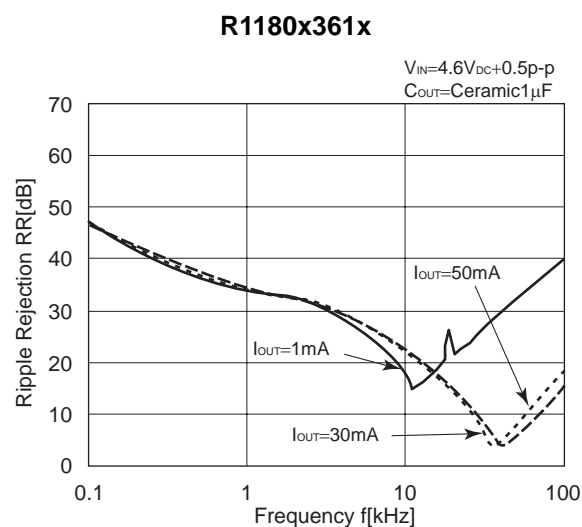
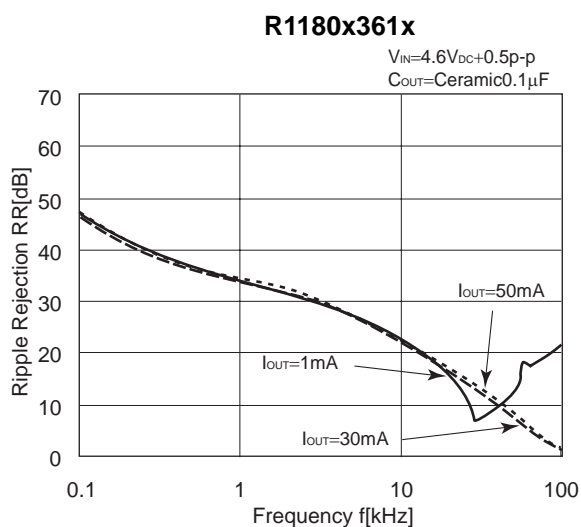

9) Ripple Rejection vs. Input Bias Voltage ( $T_{opt}=25^{\circ}C$ ,  $C_{IN}=\text{none}$ ,  $C_{OUT}=\text{Ceramic}0.1\mu F$ )

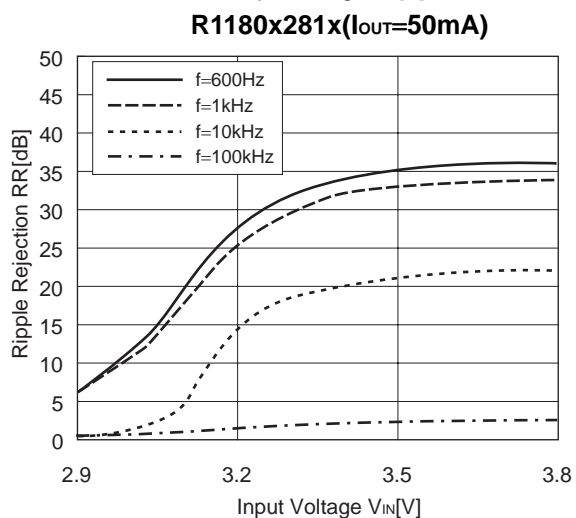
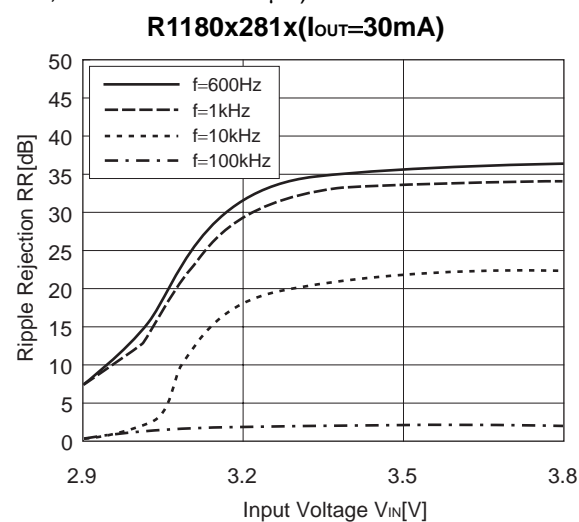
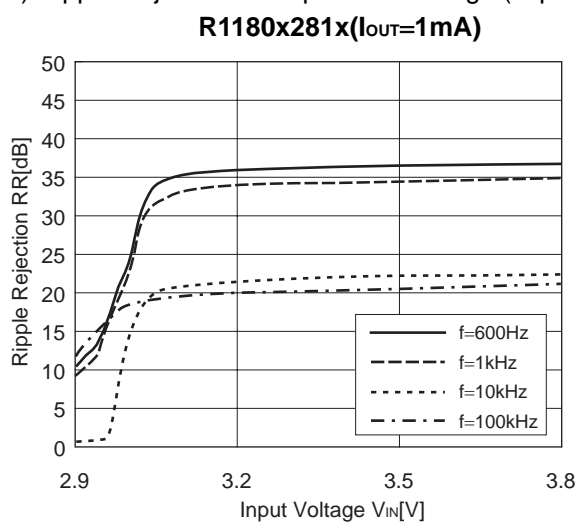

10) Input Transient Response ( $C_{IN}=none, tr=tf=5\mu s$ )

R1180x281x

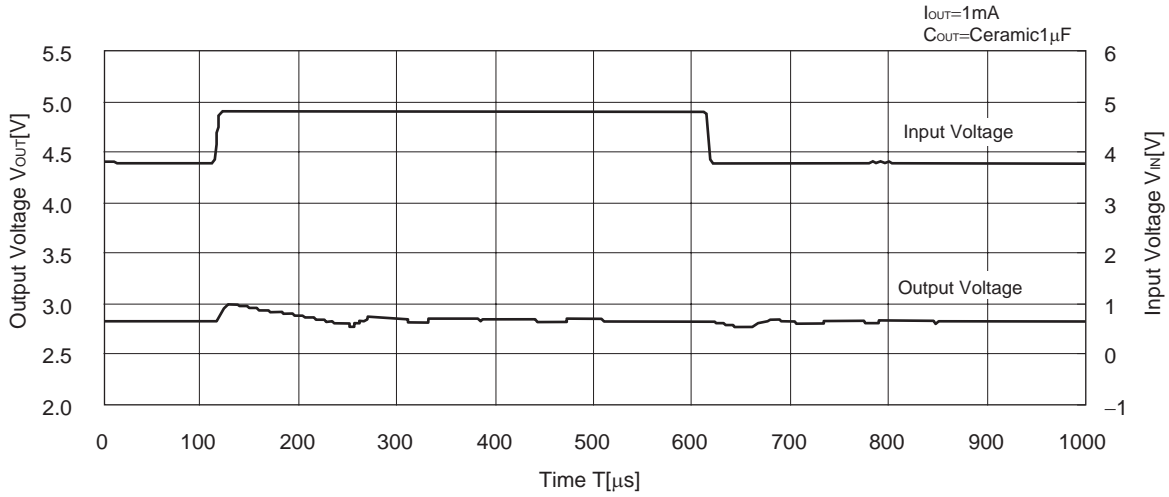

R1180x281x

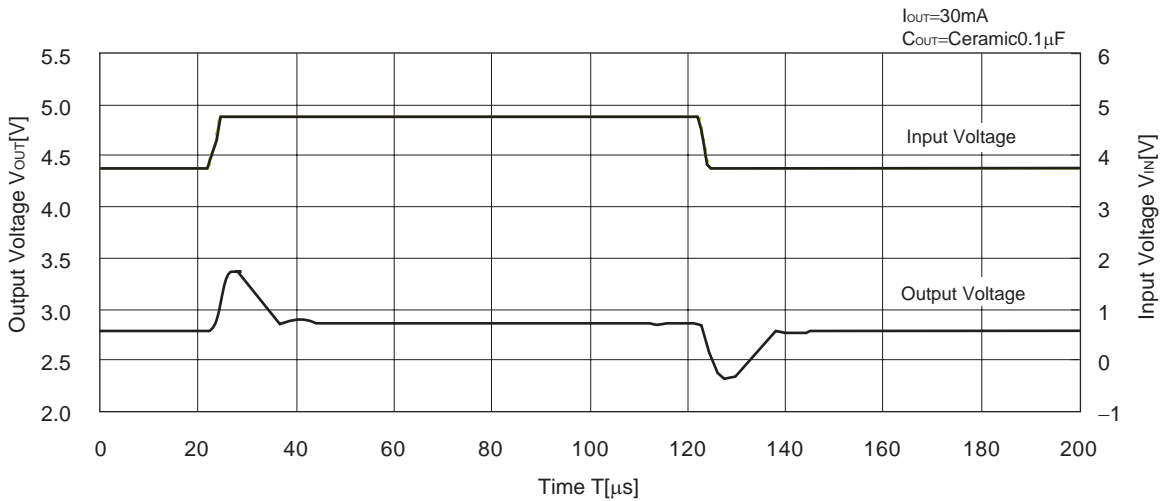

R1180x281x

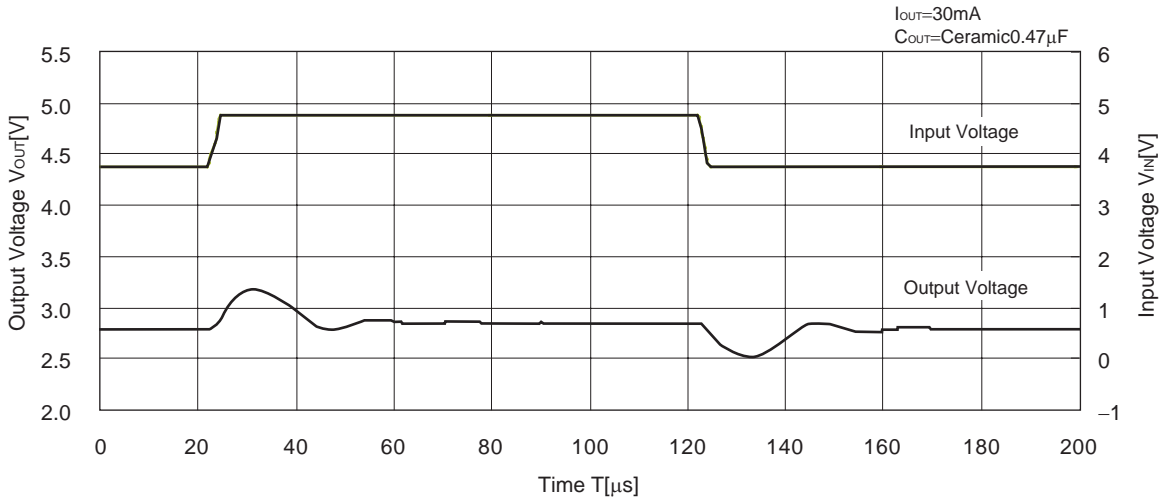

R1180x281x

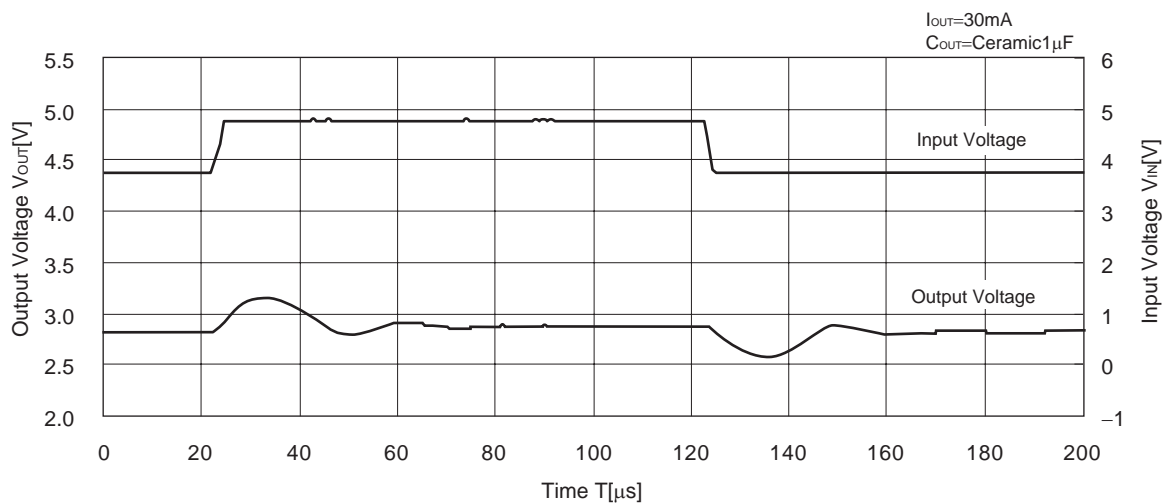

11) Load Transient Response ( $t_r=t_f=0.5\mu\text{s}$   $V_{IN}=3.8\text{V}$ )

R1180x281x

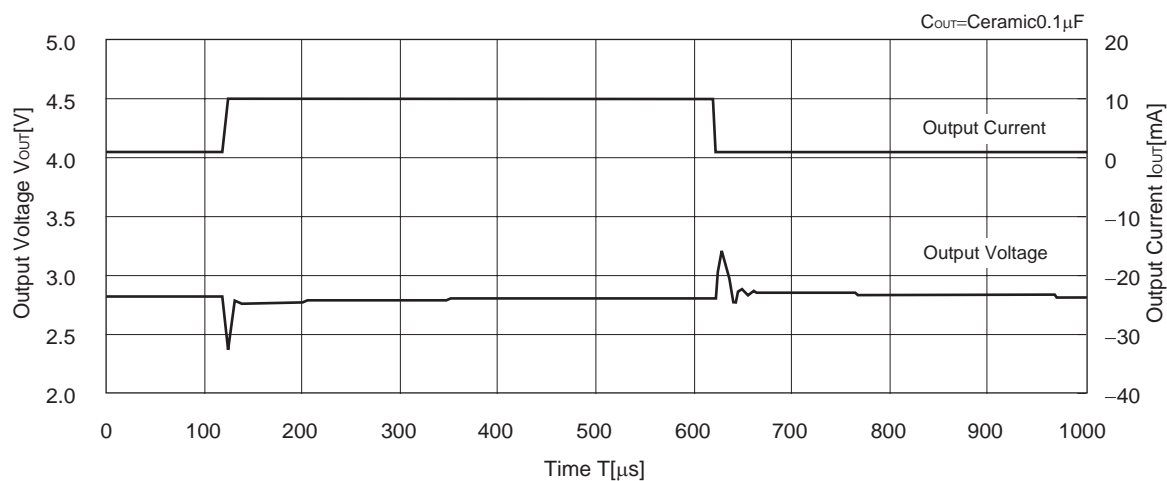

R1180x281x

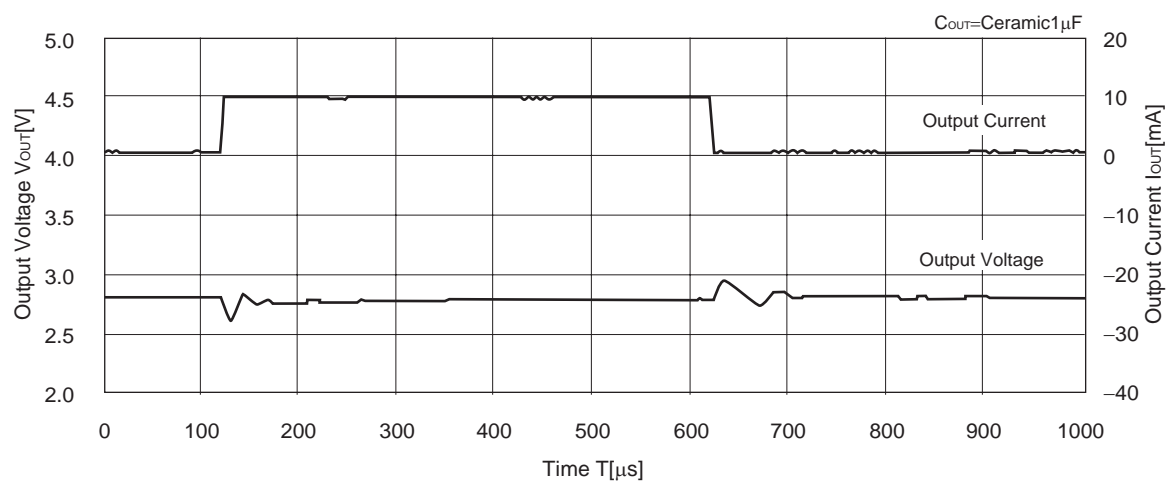

R1180x281x

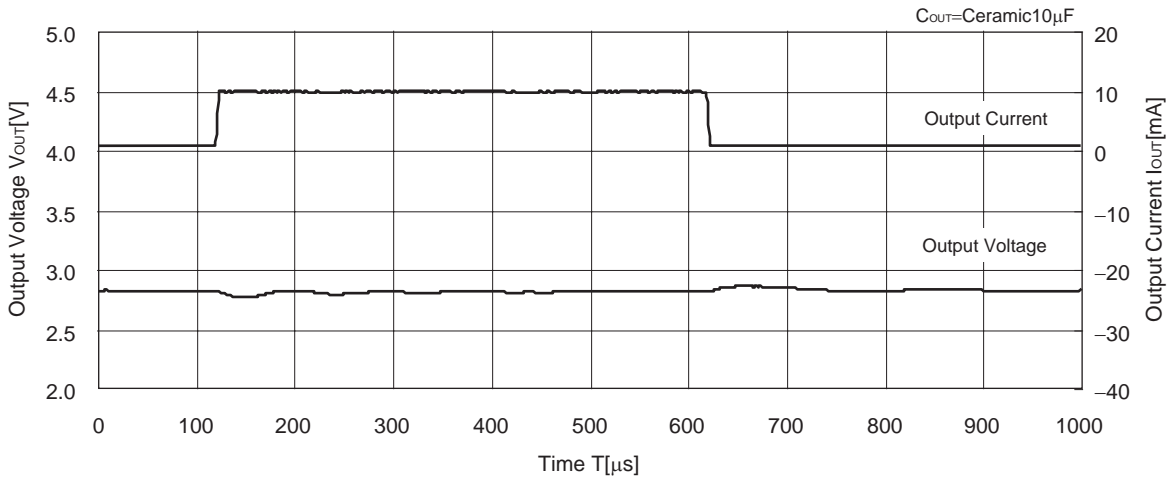

R1180x281x

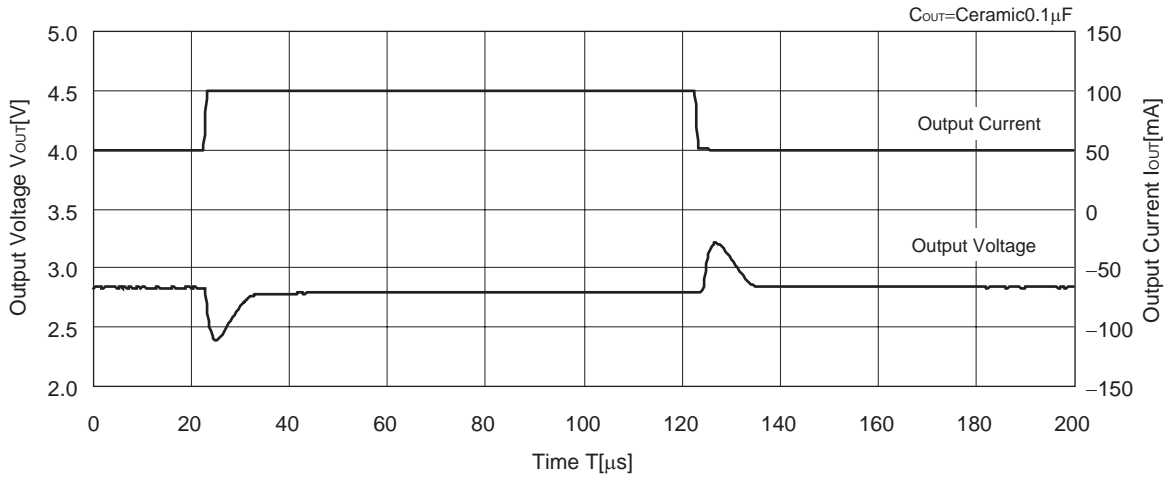

R1180x281x

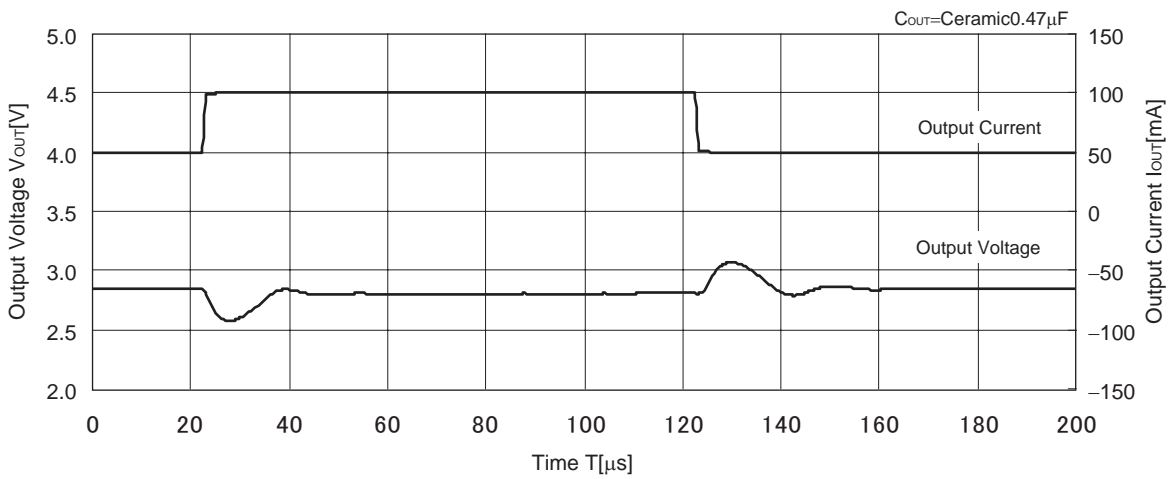



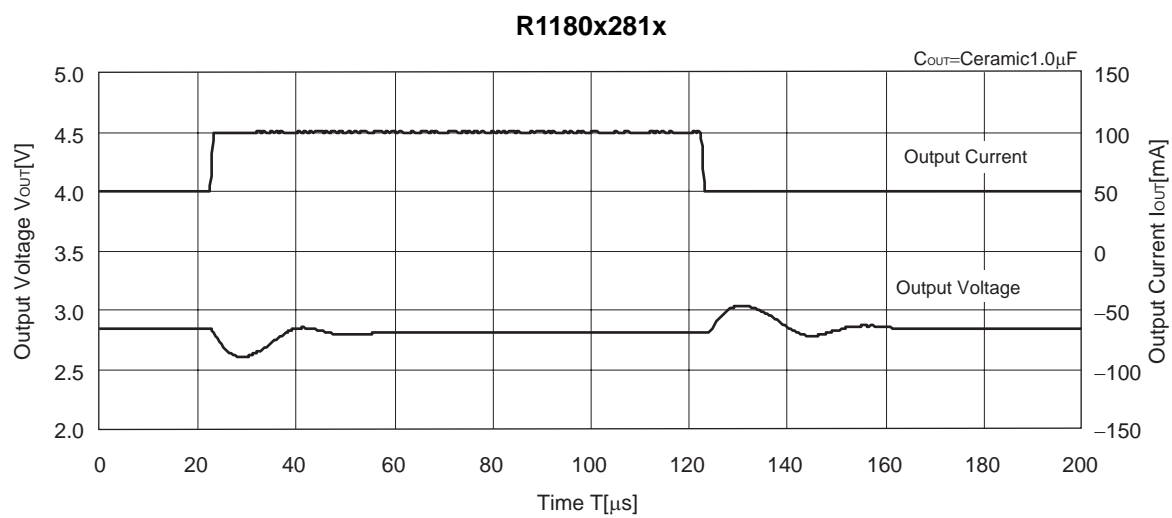

## ESR vs. Output Current

The relations between  $I_{OUT}$  (Output Current) and ESR of an output capacitor are shown above. The conditions when the white noise level is under  $40\mu V$  (Avg.) are marked as the hatched area in the graph.

<Measurement conditions>

- (1)  $V_{IN}=V_{OUT}+1V$
- (2) Frequency Band: 10Hz to 2MHz (BW=30Hz)
- (3) Temperature:  $-40^{\circ}C$  to  $85^{\circ}C$

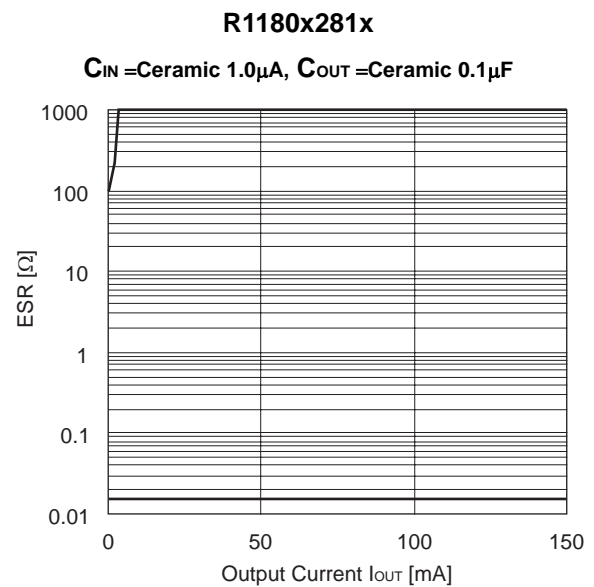
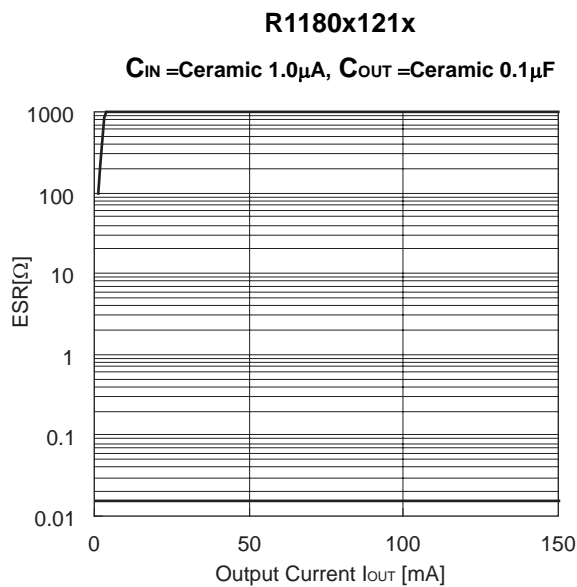



1. The products and the product specifications described in this document are subject to change or discontinuation of production without notice for reasons such as improvement. Therefore, before deciding to use the products, please refer to Ricoh sales representatives for the latest information thereon.
2. The materials in this document may not be copied or otherwise reproduced in whole or in part without prior written consent of Ricoh.
3. Please be sure to take any necessary formalities under relevant laws or regulations before exporting or otherwise taking out of your country the products or the technical information described herein.
4. The technical information described in this document shows typical characteristics of and example application circuits for the products. The release of such information is not to be construed as a warranty of or a grant of license under Ricoh's or any third party's intellectual property rights or any other rights.
5. The products listed in this document are intended and designed for use as general electronic components in standard applications (office equipment, telecommunication equipment, measuring instruments, consumer electronic products, amusement equipment etc.). Those customers intending to use a product in an application requiring extreme quality and reliability, for example, in a highly specific application where the failure or misoperation of the product could result in human injury or death (aircraft, spacevehicle, nuclear reactor control system, traffic control system, automotive and transportation equipment, combustion equipment, safety devices, life support system etc.) should first contact us.
6. We are making our continuous effort to improve the quality and reliability of our products, but semiconductor products are likely to fail with certain probability. In order to prevent any injury to persons or damages to property resulting from such failure, customers should be careful enough to incorporate safety measures in their design, such as redundancy feature, fire containment feature and fail-safe feature. We do not assume any liability or responsibility for any loss or damage arising from misuse or inappropriate use of the products.
7. Anti-radiation design is not implemented in the products described in this document.
8. The X-ray exposure can influence functions and characteristics of the products. Confirm the product functions and characteristics in the evaluation stage.
9. WLCSP products should be used in light shielded environments. The light exposure can influence functions and characteristics of the products under operation or storage.
10. There can be variation in the marking when different AOI (Automated Optical Inspection) equipment is used. In the case of recognizing the marking characteristic with AOI, please contact Ricoh sales or our distributor before attempting to use AOI.
11. Please contact Ricoh sales representatives should you have any questions or comments concerning the products or the technical information.



**Ricoh is committed to reducing the environmental loading materials in electrical devices with a view to contributing to the protection of human health and the environment.**

Ricoh has been providing RoHS compliant products since April 1, 2006 and Halogen-free products since April 1, 2012.

**RICOH** RICOH ELECTRONIC DEVICES CO., LTD.

<https://www.e-devices.ricoh.co.jp/en/>

#### Sales & Support Offices

##### **Ricoh Electronic Devices Co., Ltd.**

##### **Shin-Yokohama Office (International Sales)**

2-3, Shin-Yokohama 3-chome, Kohoku-ku, Yokohama-shi, Kanagawa, 222-8530, Japan  
Phone: +81-50-3814-7687 Fax: +81-45-474-0074

##### **Ricoh Americas Holdings, Inc.**

675 Campbell Technology Parkway, Suite 200 Campbell, CA 95008, U.S.A.  
Phone: +1-408-610-3105

##### **Ricoh Europe (Netherlands) B.V.**

##### **Semiconductor Support Centre**

Prof. W.H. Keesomlaan 1, 1183 DJ Amstelveen, The Netherlands  
Phone: +31-20-5474-309

##### **Ricoh International B.V. - German Branch**

##### **Semiconductor Sales and Support Centre**

Oberrather Strasse 6, 40472 Düsseldorf, Germany  
Phone: +49-211-6546-0

##### **Ricoh Electronic Devices Korea Co., Ltd.**

3F, Haesung Bldg, 504, Teheran-ro, Gangnam-gu, Seoul, 135-725, Korea  
Phone: +82-2-2135-5700 Fax: +82-2-2051-5713

##### **Ricoh Electronic Devices Shanghai Co., Ltd.**

Room 403, No.2 Building, No.690 Bibo Road, Pu Dong New District, Shanghai 201203,  
People's Republic of China  
Phone: +86-21-5027-3200 Fax: +86-21-5027-3299

##### **Ricoh Electronic Devices Shanghai Co., Ltd.**

##### **Shenzhen Branch**

1205, Block D (Jinlong Building), Kingkey 100, Hongbao Road, Luohu District,  
Shenzhen, China  
Phone: +86-755-8348-7600 Ext 225

##### **Ricoh Electronic Devices Co., Ltd.**

##### **Taipei office**

Room 109, 10F-1, No.51, Hengyang Rd., Taipei City, Taiwan (R.O.C.)  
Phone: +886-2-2313-1621/1622 Fax: +886-2-2313-1623

# Mouser Electronics

Authorized Distributor

Click to View Pricing, Inventory, Delivery & Lifecycle Information:

## Ricoh Electronics:

[R1180N151C-TR-FE](#) [R1180N301C-TR-FE](#) [R1180Q181B-TR-FE](#) [R1180N151B-TR-FE](#) [R1180N331C-TR-FE](#)  
[R1180Q181C-TR-FE](#) [R1180N281B-TR-FE](#) [R1180Q281C-TR-FE](#) [R1180N121B-TR-FE](#) [R1180N331B-TR-FE](#)  
[R1180N181B-TR-FE](#) [R1180N301B-TR-FE](#) [R1180N251B-TR-FE](#) [R1180D181B-TR-FE](#) [R1180N261B-TR-FE](#)  
[R1180Q121B-TR-FE](#) [R1180D331B-TR-FE](#) [R1180Q231B-TR-FE](#) [R1180Q251B-TR-FE](#) [R1180N271C-TR-FE](#)  
[R1180Q151B-TR-FE](#) [R1180Q301C-TR-FE](#) [R1180N291C-TR-FE](#) [R1180Q351B-TR-FE](#) [R1180N321B-TR-FE](#)  
[R1180Q281B-TR-FE](#) [R1180D301C-TR-FE](#) [R1180N311C-TR-FE](#) [R1180D241C-TR-FE](#) [R1180D121B-TR-FE](#)  
[R1180D151B-TR-FE](#) [R1180Q221B-TR-FE](#) [R1180Q221C-TR-FE](#) [R1180D211C-TR-FE](#) [R1180D151C-TR-FE](#)  
[R1180D251B-TR-FE](#) [R1180N361B-TR-FE](#) [R1180Q241B-TR-FE](#) [R1180D281B-TR-FE](#) [R1180Q331C-TR-FE](#)  
[R1180D301B-TR-FE](#) [R1180D231C-TR-FE](#) [R1180Q301B-TR-FE](#) [R1180Q211B-TR-FE](#) [R1180Q331B-TR-FE](#)  
[R1180D221B-TR-FE](#) [R1180D181B5-TR-FE](#) [R1180D281C-TR-FE](#) [R1180Q211C-TR-FE](#) [R1180D121C-TR-FE](#)  
[R1180D131B-TR-FE](#) [R1180D131C-TR-FE](#) [R1180D141B-TR-FE](#) [R1180D161B-TR-FE](#) [R1180D161C-TR-FE](#)  
[R1180D321B-TR-FE](#) [R1180D321C-TR-FE](#) [R1180D331C-TR-FE](#) [R1180D331D-TR-FE](#) [R1180D351B-TR-FE](#)  
[R1180Q291C-TR-FE](#) [R1180Q311B-TR-FE](#) [R1180Q321B-TR-FE](#) [R1180Q341B-TR-FE](#) [R1180D291B-TR-FE](#)  
[R1180D311B-TR-FE](#) [R1180Q201C-TR-FE](#) [R1180Q231C-TR-FE](#) [R1180Q261B-TR-FE](#) [R1180Q271B-TR-FE](#)  
[R1180Q271C-TR-FE](#) [R1180Q291B-TR-FE](#) [R1180Q121C-TR-FE](#) [R1180Q131B-TR-FE](#) [R1180Q141B-TR-FE](#)  
[R1180Q151C-TR-FE](#) [R1180Q191B-TR-FE](#) [R1180Q191C-TR-FE](#) [R1180N281C-TR-FE](#) [R1180N291B-TR-FE](#)  
[R1180N311B-TR-FE](#) [R1180N321C-TR-FE](#) [R1180N351B-TR-FE](#) [R1180N361C-TR-FE](#) [R1180N211C-TR-FE](#)  
[R1180N221B-TR-FE](#) [R1180N221C-TR-FE](#) [R1180N231C-TR-FE](#) [R1180N251C-TR-FE](#) [R1180N271B-TR-FE](#)  
[R1180N121C-TR-FE](#) [R1180N131B-TR-FE](#) [R1180N141B-TR-FE](#) [R1180N161B-TR-FE](#) [R1180N181C-TR-FE](#)  
[R1180N201B-TR-FE](#) [R1180D231B-TR-FE](#) [R1180D251C-TR-FE](#) [R1180D261B-TR-FE](#) [R1180D261C-TR-FE](#)