

16-bit and 32-bit Controllers Software Resources

Summer 2011



Software Solutions and Tools for the 16-bit and 32-bit Designer

A comprehensive overview of software libraries, application solutions and software development tools for Microchip's PIC24, dsPIC® and PIC32 embedded control product families.

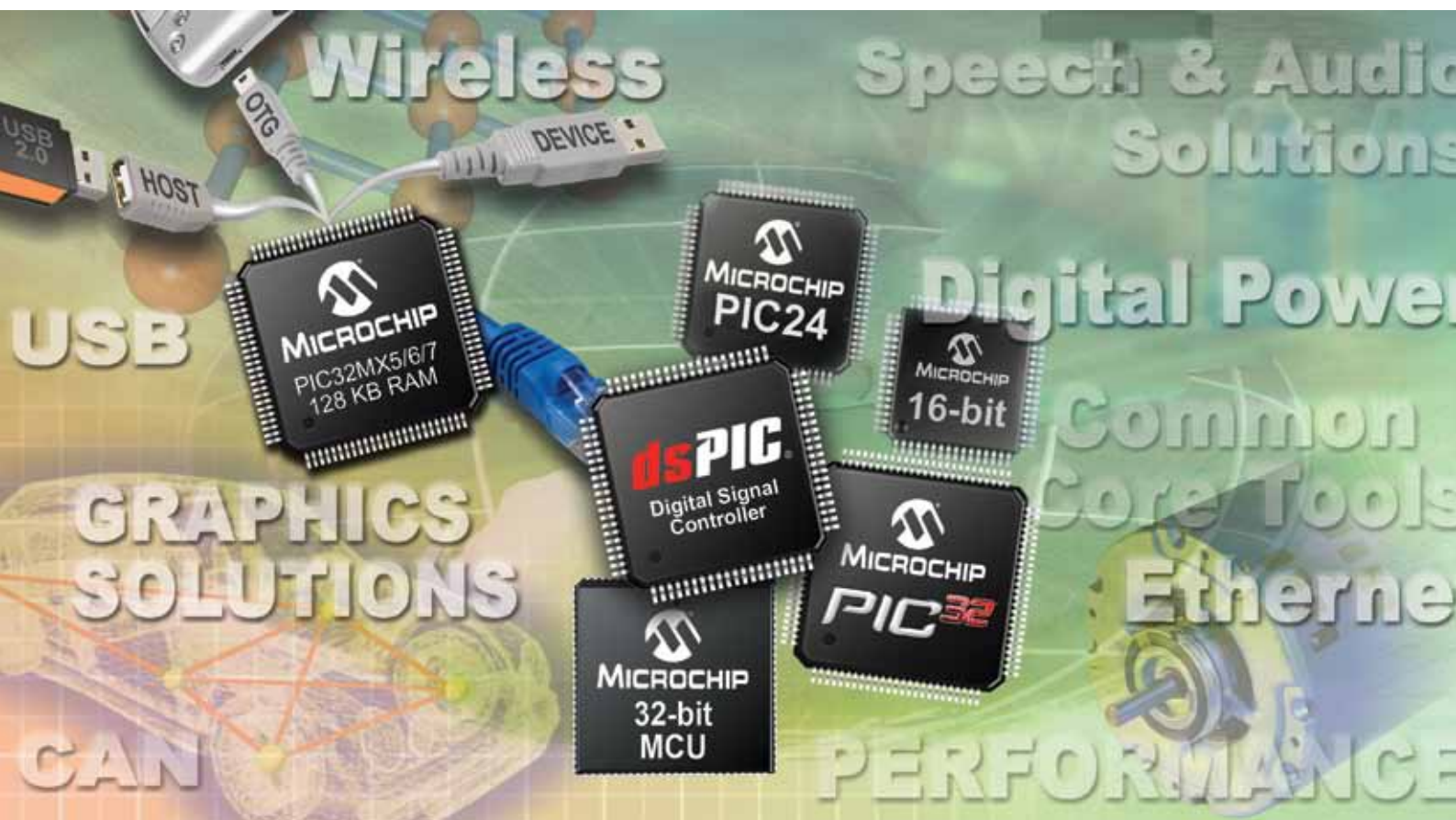

www.microchip.com/16bit
www.microchip.com/32bit

Software Solutions and Tools for the 16-bit and 32-bit Designer

Table of Contents

Topic	Product	Part Number	Page
Software Library	dsPIC DSC Noise Suppression Library	SW300040	7
	dsPIC DSC Acoustic Echo Cancellation Library	SW300060	8
	dsPIC DSC Line Echo Cancellation Library	SW300080	9
	dsPIC DSC Equalizer Library	–	9
	dsPIC DSC Automatic Gain Control Library	–	10
	PIC24/dsPIC DSC G.711 Speech Encoding/Decoding Library	SW300026	10
	dsPIC DSC G.726A Speech Encoding/Decoding Library	SW300090	11
	dsPIC DSC Speex Speech Encoding/Decoding Library	SW300070	11
	ADPCM and Speex (Audio) Library for PIC32 MCUs	–	12
	dsPIC DSC Symmetric Key Embedded Encryption Library	SW300050	13
	dsPIC DSC Asymmetric Key Embedded Encryption Library	SW300055	14
	Data Encryption Libraries	SW300052	15
	dsPIC DSC DSP Algorithm Library	Included in MPLAB® C Compiler	16
	PIC32 MCU DSP Library	Included in MPLAB C Compiler	17
	PIC24 MCU/dsPIC DSC Floating Point Math Library	Included in MPLAB C Compiler	18
	PIC24 MCU/dsPIC DSC Fixed Point Math Library	Included in MPLAB C Compiler	18
	PIC32 MCU Floating Point Math Library	Included in MPLAB C Compiler	19
	PIC24 MCU/dsPIC DSC Peripheral Library	Included in MPLAB C Compiler	20
	PIC32 MCU Peripheral Library	Included in MPLAB C Compiler	20
	Microchip USB Framework	–	21
	Microchip Graphics Library	–	21
	Image Decoder Library	–	22
	dsPIC DSC DTMF Generation/Detection Libraries	–	22
	Microchip TCP/IP Stack	–	23
	IEEE 802.11 Wi-Fi®	–	24
	IEEE 802.15.4: Microchip MiWi™ and MiWi P2P Protocol	–	24
	IEEE 802.15.4: ZigBee®, ZigBee PRO, ZigBee Smart Energy Profile Suite	–	25
	PIC32 CAN Library Using MCP2515 CAN Controller	–	25
	Bluetooth® Stack for PIC24 and PIC32 MCUs and dsPIC DSCs	–	26
	Microchip FAT File System for PIC24 and PIC32 MCUs and dsPIC DSCs	–	26
	FATFs File System for PIC32 MCUs	–	27
	Data EEPROM Emulation for PIC18, PIC24 and PIC32 MCUs and dsPIC DSCs	AN1095	27
	Memory Disk Drive File System for PIC18, PIC24 and PIC32 MCUs and dsPIC DSCs	–	28
	PMBus Stack	–	28
Class B Safety Software Library for PIC® MCUs and dsPIC DSCs	AN1229	29	
mTouch™ Capacitive Touch Library	–	29	
Consumer-band BPSK-based 7.2 kbps Powerline Soft Modem Demonstration Software	AC164142	30	

Software Solutions and Tools for the 16-bit and 32-bit Designer

Table of Contents

Topic	Product	Part Number	Page
Application Solutions	Sensorless BLDC Motor Control Using a dsPIC30F or dsPIC33F	AN901	32
	Using a dsPIC30F or dsPIC33F for Vector Control of an ACIM	AN908	33
	Sensored BLDC Motor Control Using a dsPIC30F or dsPIC33F	AN957	33
	Introduction to AC Induction Motor Control Using a dsPIC30F or dsPIC33F	AN984	34
	Using a dsPIC30F for Sensorless BLDC Motor Control	AN992	34
	Sinusoidal Control of PMSM Motors with dsPIC30F or dsPIC33F Devices	AN1017	35
	Sensorless Field-Oriented Control for PMSM Motors	AN1078	35
	Power Factor Correction Using dsPIC DSCs	AN1106	36
	Sensorless BLDC Control with Back EMF Filtering Using a Majority Function	AN1160	36
	Sensorless Field Oriented Control (FOC) of an AC Induction Motor (ACIM)	AN1162	37
	Sensorless Field Oriented Control (FOC) of an AC Induction Motor (ACIM) Using Field Weakening	AN1206	37
	Integrated Power Factor Correction (PFC) and Sensorless Field Oriented Control (FOC) System	AN1208	38
	Sensorless Field Oriented Control for a Permanent Magnet Synchronous Motor Using a PLL Estimator and Field Weakening	AN1292	38
	Single-Shunt Three-Phase Current Reconstruction Algorithm for Sensorless FOC of a PMSM	AN1299	39
	Stepper Motor Control with dsPIC DSCs	AN1307	39
	Microchip TCP/IP Stack	AN833	40
	Using the C30 Compiler and the SPI Module to Interface EEPROMs with dsPIC33F and PIC24F Devices	AN1069	40
	IrDA® Standard Stack	AN1071	41
	Using the C30 Compiler to Interface Serial EEPROMs with dsPIC33F Devices	AN1100	41
	HTTP Server Using BSD Socket API for PIC32MX Devices	AN1107	42
	TCP/IP Stack with BSD Socket API for PIC32MX Devices	AN1108	42
	SNMP Agent Using BSD Socket API for PIC32MX Devices	AN1109	43
	FTP Server Using BSD Socket API for the PIC32MX Device	AN1111	43
	Using External Memory with PIC24F, PIC24H and dsPIC33F Devices	AN1210	44
	ZigBee® 2006 Protocol Stack	AN1232	44
	ECAN™ Operation with DMA on dsPIC33F and PIC24H Devices	AN1249	45
	AC-DC Reference Design	User's Guide: DS70320 AN1114, AN1207	45
	Offline UPS Reference Design	AN1279	46
	Digital Power Interleaved PFC Reference Design	AN1278	46
	Bootloader for dsPIC30F/33F and PIC24F/24H Devices	AN1094	47
	Serial Bootloader for PIC32 MCUs	AN851	47
	Serial Bootloader for PIC24F Devices	AN1157	48
	Graphics Display Solution	AN1136	48
	Using a Keyboard with the Microchip Graphics Library	AN1227	49
	Data Encryption Routines for PIC24 and PIC32 MCUs and dsPIC DSCs	AN1044	49
	Implementing Digital Lock-In Amplifiers Using a dsPIC DSC	AN1115	50
	File I/O Functions Using Memory Disk Drive File System Library	AN1045	50
	Digital LED Lighting Development Kit	DM330014	51
	Automotive Headlamp HID Ballast Reference Design Using a dsPIC® DSC Device	AN1372	51
	Grid-Connected Solar Micro Inverter Reference Design Using a dsPIC® DSC	AN1338	52
	DC/DC LLC Reference Design Using a dsPIC® DSC	AN1336	52
	Quarter Brick DC/DC Converter Reference Design	–	53
	Porting the Helix MP3 Decoder onto Microchip's PIC32MX 32-bit MCUs	AN1367	53

Software Solutions and Tools for the 16-bit and 32-bit Designer

Table of Contents

Topic	Product	Part Number	Page
Software and Application Development Tools	MPLAB® IDE (Integrated Development Environment) Tools	SW007002	55
	MPLAB ICD In-Circuit Debugger	DV164035	56
	MPLAB REAL ICE™ In-Circuit Emulator	DV244005	57
	PICkit™ 3 In-Circuit Debugger	PG164130	58
	MPLAB PM3 Universal Device Programmer	DV007004	59
	MPLAB C Compiler for PIC24 MCUs and dsPIC® DSCs	SW006012	60
	MPLAB C Compiler for PIC32 MCUs	SW006015	60
	dsPICworks™ Data Analysis and DSP Software	SW300021	61
	Digital Filter Design Digital Filter Design Lite	SW300001 SW300001-LT	62
	Real-Time Data Monitoring Tool	MPLAB Plug-in	63
	dsPIC DSC Speech and Audio Fast Forward (SAFF) Tool	Included in MPLAB C Compiler	64
	Microchip Graphics Display Designer	MPLAB Plug-In	64
	nanoWatt XLP Battery Life Estimator	–	65
	Google PowerMeter Reference Implementation	–	65
	Third Party Software Tools, RTOS and Libraries	–	66

Software Application Library Overview

A suite of advanced solution libraries have been developed and are available for your application requirements. The table below presents a summary of the libraries available for the PIC24 Microcontrollers (MCUs), dsPIC® Digital Signal Controllers (DSCs) and PIC32 MCUs. Additional information on each specific library is provided within this section.

Some of the benefits of the comprehensive library suite for 16- and 32-bit product families are:

- Reduce development time by using ready-made libraries
- No royalties for libraries and only a one-time license fee per project lifetime for some libraries
- Free and low cost evaluation and development support:
 - Most libraries are free downloads
 - Encryption libraries are handling cost only

Application	Application Library	Device Support					Part Number	Price
		PIC24F	PIC24H/E	dsPIC30F	dsPIC33F/E	PIC32		
Speech, Audio and Communication	dsPIC DSC Noise Suppression Library			✓	✓		SW300040	Free
	dsPIC® DSC Acoustic Echo Cancellation Library			✓	✓		SW300060	Free
	dsPIC DSC Line Echo Cancellation Library			✓	✓		SW300080	Free
	dsPIC DSC Equalizer Library			✓	✓		–	Free
	dsPIC® DSC Automatic Gain Control Library			✓	✓		–	Free
	PIC24 MCU/dsPIC® DSC G.711 Speech Encoding/Decoding Library	✓	✓	✓	✓		SW300026	Free
	dsPIC DSC G.726A Speech Encoding/Decoding Library			✓	✓		SW300090	Free
	dsPIC® DSC Speex Speech Encoding/Decoding Library			✓	✓		SW300070	Free
	ADPCM and Speex (Audio) Library for PIC32 MCUs					✓	–	Free
Encryption and Security	dsPIC DSC Symmetric Key Embedded Encryption Library			✓	✓		SW300050	\$5
	dsPIC DSC Asymmetric Key Embedded Encryption Library			✓	✓		SW300055	\$5
	Data Encryption Libraries	✓	✓	✓	✓	✓	SW300052	\$5
DSP and Math	dsPIC® DSC DSP Algorithm Library			✓	✓		Included in MPLAB C Compiler	Free
	PIC32 MCU DSP Library					✓	Included in MPLAB C Compiler	Free
	PIC24 MCU/dsPIC DSC Floating Point Math Library	✓	✓	✓	✓		Included in MPLAB C Compiler	Free
	PIC24 MCU/dsPIC DSC Fixed Point Math Library	✓	✓	✓	✓		Included in MPLAB C Compiler	Free
	PIC32 MCU Floating Point Math Library					✓	Included in MPLAB C Compiler	Free
Peripherals	PIC24 MCU/dsPIC DSC Peripheral Library	✓	✓	✓	✓		Included in MPLAB C Compiler	Free
	PIC32 MCU Peripheral Library					✓	Included in MPLAB C Compiler	Free

*Not available for dsPIC33E.

**Future support planned for PIC24E/dsPIC33E.

Software Application Library Overview

Application	Application Library	Device Support					Part Number	Price
		PIC24F	PIC24H/E	dsPIC30F	dsPIC33F/E	PIC32		
Graphics	Microchip Graphics Library	✓	✓		✓	✓	–	Free
	Image Decoder Library	✓	✓	✓	✓	✓	–	Free
	dsPIC DSC DTMF Generation/ Detection Libraries*			✓	✓		–	Free
	Microchip Graphics Display Designer	✓	✓		✓	✓	MPLAB IDE Plug-in	Free
Wired and Wireless Connectivity	Microchip TCP/IP Stack	✓	✓	✓	✓	✓	–	Free
	Microchip USB Framework	✓				✓	–	Free
	IEEE 802.11: Wi-Fi®	✓	✓	✓	✓	✓	–	Free
	IEEE 802.15.4: MiWi™ and MiWi P2P	✓	✓		✓	✓	–	Free
	IEEE 802.15.4: ZigBee® , ZigBee PRO, ZigBee Smart Energy Profile Suite	✓	✓		✓	✓	–	Free
	PIC32 CAN Library Using MCP2515 CAN Controller					✓	–	Free
	IrDA® Standard Stack**	✓	✓	✓	✓		IrDA PICtail Plus Daughter Board (AC164124)	\$25
	Bluetooth® Stack for PIC24 and PIC32 MCUs and dsPIC DSCs**		✓	✓	✓	✓	✓	dotstack™ Bluetooth Stack EVAL
							SW500151-5K (16-bit)	\$4250
							SW500155-5K (32-bit)	\$4250
File System and Memory	Microchip FAT File System for PIC24 and PIC32 MCUs and dsPIC DSCs	✓	✓		✓	✓	–	Free
	FATfs File System for PIC32 MCUs					✓	–	
	Data EEPROM Emulation for PIC18, PIC24 and PIC32 MCUs and dsPIC DSCs	✓	✓		✓	✓	–	Free
	Memory Disk Drive File System for PIC18, PIC24 and PIC32 MCUs and dsPIC DSCs	✓	✓	✓	✓	✓	–	Free
Other	PMBus Stack**				✓		–	Free
	Class B Safety Software Library for PIC® MCUs and dsPIC DSCs	✓	✓		✓		–	Free
	mTouch™ Capacitive Touch Library	✓	✓	✓	✓	✓	–	Free
	PIC32 CAN Library Using MCP2515 CAN Controller					✓	–	Free
	Consumer-band BPSK-based 7.2 kbps Powerline Soft Modem Demonstration Software**				✓		–	Free
	nanoWatt XLP Battery Life Estimator	✓					–	Free
	Google PowerMeter Reference Implementation**	✓	✓		✓	✓	–	Free
	Digital Filter Design			✓	✓		SW300001	\$249
	Digital Filter Design Lite			✓	✓		SW300001-LT	\$29

*Not available for dsPIC33E.

**Future support planned for PIC24E/dsPIC33E.

dsPIC® DSC Noise Suppression Library (SW300040)

Summary

The dsPIC® DSC Noise Suppression Library provides a function to suppress the effect of noise in a speech signal. This function is useful for microphone-based applications that have a potential for incoming speech corruption from ambient noise. It is especially suitable for systems where an acoustically isolated noise reference is not available. The noise suppression library removes noise from a 10 ms block of 16-bit speech data sampled at 8 kHz. Fast Fourier Transform (FFT) is performed on each 10 ms block of data to analyze the frequency components of the signal. The library, adapts to changes in the nature and level of noise, and does not require a separate noise reference input.

Key Features

- 0 dB to 44 dB noise reduction
- Audio bandwidth: 0-4 kHz at 8 kHz sampling rate
- Simple user interface – only one library file and one header file
- All functions called from a C application program
- Full compliance with the MPLAB® C Compiler, Assembler and Linker
- Highly optimized assembly code that uses DSP instructions and advanced addressing modes
- Comprehensive API provides parametric control of the noise suppression engine
- Supported by Microchip SAFF Tool

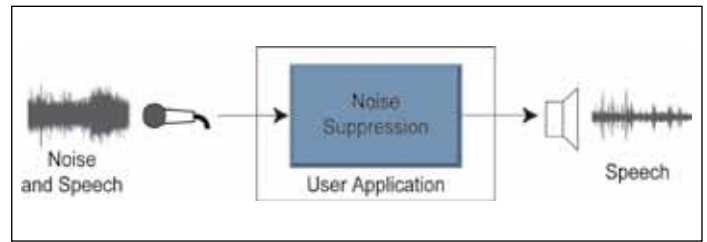

Applications

- Hands-free cell phone kits
- Speaker phones
- Intercoms
- Teleconferencing systems
- Headsets
- A front-end to a speech recognition system
- Any microphone-based application that needs to eliminate undesired noise

dsPIC® DSC Acoustic Echo Cancellation Library (sw300060)

Summary

The dsPIC® DSC Acoustic Echo Cancellation (AEC) Library is fully compatible with G.167 standard for Acoustic Echo Cancellation. The software library provides a function to eliminate echo generated in the acoustic path between a speaker and a microphone. This function is useful for speech and telephony applications in which a speaker and a microphone are located in close proximity to each other, and therefore susceptible to signals propagating from the speaker to the microphone resulting in a perceptible and distracting echo effect at the far end.

Key Features

- Simple user interface – only one library file and one header file
- All functions can be called from a C application program
- Compatible with the Microchip C30 Compiler, Assembler and Linker
- Highly optimized assembly code that uses DSP instructions and advanced addressing modes
- Acoustic echo cancellation for 16, 32, 64 or 128 ms echo delays or “tail lengths” (configurable)
- Fully tested for compliance with G.167 specifications for in-car applications
- Audio bandwidth: 0 to 4 kHz at 8 kHz sampling rate
- Convergence Rate: Up to 47 dB/sec., typically greater than 30 dB/sec
- Acoustic echo cancellation: Up to 50 dB, typically > 40 dB
- Can be used together with the Noise Suppression (NS) Library

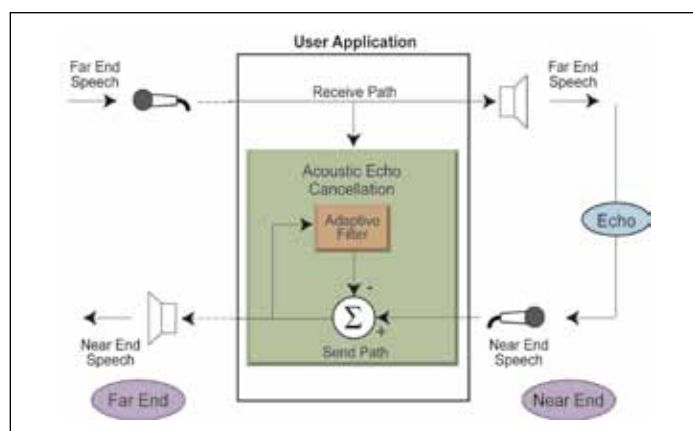

- Demo application source code is provided with the Library
- Can be instantiated multiple times to support multiple input audio streams.
- NLP attenuation level can be adjusted to suit application requirements
- Acoustic echo cancellation adaptation can be force-enabled or disabled by the user application
- Run-time control of key algorithm parameters is provided

Applications

- Automobile hands-free cell phone kits
- Speaker phones
- Intercoms
- Teleconferencing systems

dsPIC® DSC Line Echo Cancellation Library (SW300080)

Summary

The dsPIC® DSC Line Echo Cancellation (LEC) Library is compatible with the ITU-T G.168 standard. It provides a function to eliminate echo generated in telephone or digital network components. LEC library functions can be used to eliminate far-end as well as near-end echo.

Key Features

- Line echo cancellation for 16, 32, 64 or 128 ms echo delays
- Audio bandwidth: 0 to 4 kHz at 8 kHz sampling rate
- Convergence Rate: Up to 60 dB/sec., typically greater than 30 dB/sec
- Can be used together with the Noise Suppression (NS) Library
- Can be instantiated multiple times to support multiple input audio streams
- Line echo cancellation adaptation can be force-enabled or disabled by the user application
- Tone detection for disabling LEC during test or measurement processes
- Run-time control of key algorithm parameters is provided
- Supported by Microchip SAFF Tool

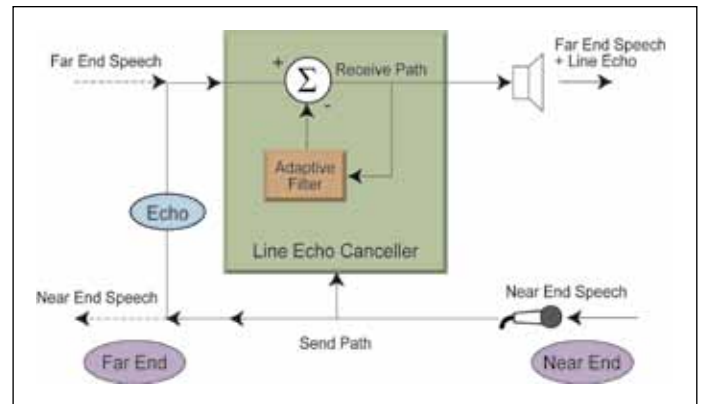

Applications

- Hands-free cell phone kits
- Speaker phones
- Intercoms
- Teleconferencing systems
- Voice over internet protocol

dsPIC® DSC Equalizer Library

Summary

The dsPIC® DSC Equalizer Library provides functionality to adjust the spectral characteristics of a voice band signal. The equalizer library enables compensation for the changes in total properties of the voice signal resulting because of signal processing and mechanical limitations of Input-Output devices. Equalizer library enables user to modify the spectral characteristics of the signal.

Key Features

- Audio bandwidth sampling rate at 8 KHz
- Quality factor of 1.4 for each band-pass filter
- Individual band gain control from 0-18 dB
- Master gain control from 0-12 dB
- Can be integrated with the dsPIC DSC Noise Suppression, Acoustic Echo Cancellation and Line Echo Cancellation libraries
- Can process multiple audio streams
- Simple user interface – only one library file and one header file
- Supported by Microchip SAFF Tool

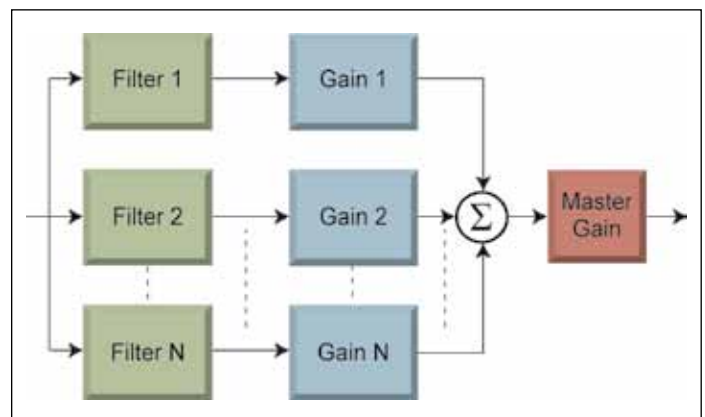

Applications

- Hands-free cell phone kits
- Speaker phones
- Intercoms
- Teleconferencing systems

FREE dsPIC® DSC Automatic Gain Control Library

Summary

The dsPIC® DSC Automatic Gain Control Library automatically adjusts the amplitude of a speech signal to match a set level. This is useful in speech applications where the distance between the speech source and the microphone is not fixed. The automatic gain control library can be used readily with Microchip's speech and audio solutions for speech signal pre-processing.

Key Features

- Input signal clip detection
- Hooks to control gain of external codec
- Gain attack, release and leakage rate controls
- Audio bandwidth: 8-48 kHz sampling rate
- All functions called from a C application program
- Full compliance with the Microchip MPLAB C Compiler, Assembler and Linker
- Highly optimized assembly code that uses the DSP instructions and advanced addressing modes
- Comprehensive API provides parametric control of the AGC engine

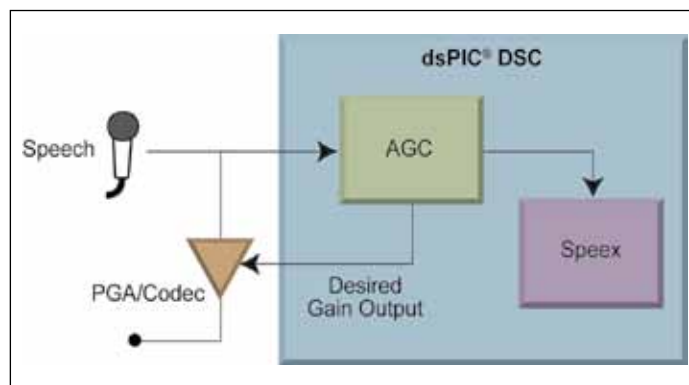

Applications

- Hands-free cell phone kits
- Speaker phones
- Intercoms
- Headsets
- Front-end to a speech recognition system or speech encoding algorithm

FREE PIC24/dsPIC® DSC G.711 Speech Encoding/Decoding Library (SW300026)

Summary

The PIC24/dsPIC® DSC G.711 Speech Encoding/Decoding Library performs toll-quality voice compression and voice decompression. The library is an implementation of the ITU-T G.711 standard on the dsPIC DSC and PIC24 MCU. The encoding algorithm used is either A-law or μ -law companding (user-selectable), and features a 2:1 compression ratio. The G.711 library can be used for both half-duplex and full-duplex systems.

Key Features

- A-law or μ -law based coding
- Playback-only applications benefit from the speech encoder utility. Encoded files can be created from the desktop using a PC microphone or WAV file

G.711

Compression Ratio	2:1
Sampling Frequency	8 KHz
Output Data Rate	64 Kbps
MIPS	1
MOS	4-4.5
Memory	8 KB/Sec of Speech

Applications

- Intercoms
- Emergency phones
- Walkie-talkies
- Mobile hands-free kits
- Digital radios
- Voice-over-IP telephony

dsPIC® DSC G.726A Speech Encoding/Decoding Library (SW300090)

Summary

The dsPIC® DSC G.726A Speech Encoding/Decoding Library performs toll-quality voice compression and voice decompression. The encoding algorithm used is Adaptive Differential Pulse Code Modulation (ADPCM). The compression can be configured by the user to be either 3.2:1, 4:1, 5.33:1 and 8:1, corresponding to output data rates of 40, 32, 24 and 16 kbps respectively. The G.726A library is suitable for both half-duplex and full-duplex systems.

Key Features

- Adaptive Differential Pulse Code Modulation (ADPCM) – based coding
- Playback-only applications benefit from the speech encoder utility. Encoded files can be created from the desktop using a PC microphone or WAV file

G.726A

Compression Ratio	3.2:1 to 8:1
Sampling Frequency	8 KHz
Output Data Rate	16-40 Kbps
MIPS	15
MOS	3.5-4.5
Memory	2-5 KB/Sec of Speech

Applications

- Intercoms
- Emergency phones
- Walkie-talkies
- Mobile hands-free kits
- Digital radios
- Voice-over-IP telephony
- Building and home safety systems
- Smart appliances
- Voice recorders
- Answering machines

dsPIC® DSC Speex Speech Encoding/Decoding Library (SW300070)

Summary

The dsPIC® DSC Speex Speech Encoding/Decoding Library performs toll-quality voice compression and voice decompression. The library is a modified version of the Speex speech coder made specifically for the dsPIC DSC families and features a multiple compression ratio. Encoding uses popular Code Excited Linear Prediction (CELP) techniques. The library is appropriate for both half-duplex and full-duplex systems.

Key Features

- Multiple encoders and/or decoders can be instantiated
- Full-duplex and half-duplex operations
- Compact and concise API for easier integration with application

Compression Ratio	16:1 / 11.6:1	26:1/20:1
Sampling Frequency	8 KHz	16 KHz
Output Data Rate	8 Kbps/11 Kbps	9.8/12.8 Kbps
MIPS	20	30
MOS	3.7-4.2	3.5-4

PC-based Speech Encoder Utility Program

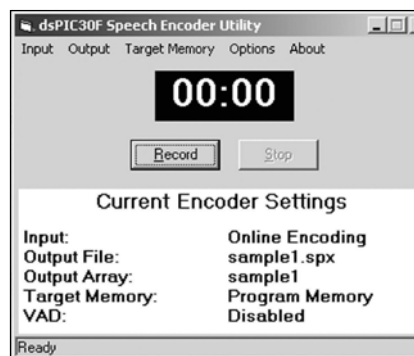

Applications

- Answering machines
- Building and home safety systems
- Intercoms
- Smart appliances
- Voice recorders
- Walkie-talkies
- Any application using message playback

ADPCM and Speex (Audio) Library for PIC32 MCUs

Summary

The audio library for PIC32 MCUs consists of APIs for Pulse Code Modulation, Adaptive Differential Pulse Code Modulation and Speex encoding and decoding algorithms. Speex is an Code Excited Linear Prediction (CELP) based open source patent-free audio compression format designed for speech. The ADPCM algorithm takes advantage of the high correlation between consecutive speech samples, which enables future sample values to be predicted.

Key Features

- Free software/open-source, patent and royalty-free
- Portable across all PIC32 microcontrollers
- Supported encoding formats: PCM (raw, uncompressed), IMA ADPCM, Speex
- Implements an audio player behavior with play, record, pause, stop functionality
- Supports standard input/output stream formats: Wave, Ogg for Speex, as well as a raw format containing just data

- Supports various sampling rates in both play and record mode
- Supports narrowband (8 KHz) and wideband (16 KHz) bit-streams for Speex
- Provides information about the missed samples
- User selectable ratio between the sampling frequency and the play/record frequency

Applications

- Answering machines
- Building and home safety systems
- Intercoms
- Smart appliances
- Voice recorders
- Walkie-talkies
- Toys and robots
- Any application using message playback

dsPIC® DSC Symmetric Key Embedded Encryption Library (SW300050)

Summary

Microchip offers a reliable security solution for embedded applications built on the dsPIC® Digital Signal Controller (DSC) platform. This solution is provided by means of Symmetric Key Encryption Library.

Key Features

- Symmetric key encryption/decryption functions support multiple modes of operation:
 - Electronic Code Book (ECB) mode
 - Cipher Block Chaining with Message Authentication (CBC-MAC) mode
 - Counter (CTR) mode
 - Combined CBC-MAC and Counter (CCM) mode

- C-callable library functions developed in MPLAB® ASM30 Assembly language
- Optimized for speed, code size and RAM usage
- Library functions extensively tested for adherence to applicable standards

Applications

- Mobile and wireless devices, PDAs
- Secure banking and web transactions
- ZigBee® technology and other monitoring and control applications
- Smart card readers/trusted card readers
- Friend/foe identification
- Secure devices and peripherals interoperating with TCG and NGSCB PCs

Cryptographic Functions

Cryptographic Algorithm	Applicable Specification	Cryptographic Function ⁽²⁾	Code Size (bytes)	Data Rate ⁽⁴⁾ (Kbps)
RNG	ANSI X9.82, FIPS 180-2	Deterministic Random Bit Generator	1353	–
SHA-1	FIPS 180-2	Secure Hash Algorithm – 160-bit	909	563
MD5	RFC 1321	Message Digest – 128-bit	1428	872
T-DES	FIPS 46-3	Basic Encryption and Decryption	8892	65 ⁽³⁾
	FIPS 46-3	ECB Wrapper ⁽¹⁾	123	
	NISTSP 800-38A	CBC Wrapper ⁽¹⁾	903	
	NISTSP 800-38A	CTR Wrapper ⁽¹⁾	348	
AES (128-bit)	FIPS 197	Basic Encryption	2505	309 ⁽³⁾
	FIPS 197	Basic Decryption	2895	
	FIPS 197	ECB Wrapper ⁽¹⁾	234	
	FIPS 113	CBC-MAC Encryption Wrapper ⁽¹⁾	663	
	NISTSP 800-38A	CBC Decryption Wrapper ⁽¹⁾	357	
	NISTSP 800-38A	CTR Wrapper ⁽¹⁾	348	
	IEEE 802.11i	CCM Wrapper ⁽¹⁾	930	

- Notes: 1. Wrapper functions are used in combination with the underlying basic encryption and/or decryption functions for the respective algorithm (AES,T-DES).
 2. All library functions use the stack and require input and output message buffers to be set up by the calling application, stack usage is below 60 bytes of RAM.
 3. AES and T-DES data rate represents the average of the data rates for performing basic encryption and decryption functions for a single block of data.
 4. All data rate statistics shown here assume device operation of 40 MIPS.

dsPIC® DSC Asymmetric Key Embedded Encryption Library (SW300055)

Summary

Microchip offers a reliable security solution for embedded applications built on the dsPIC Digital Signal Controller (DSC) platform. This solution is provided by means of Asymmetric Key Encryption Library.

Key Features⁽⁴⁾

- SC-callable library functions developed in MPLAB® ASM30 Assembly language
- Optimized for speed, code size and RAM usage
 - RAM usage below 100 bytes
- Library functions extensively tested for adherence to applicable standards
- Fast execution of algorithms
- RSA Encryption and Verification functions execute in 3.95 ms for a 17-bit exponent

- RSA Decryption and Signing functions execute in 85.71 ms for a 17-bit exponent
- DSA Signing function executes in 45 ms
- DSA Verification function executes in 85.71 ms
- Diffie-Hellman key agreement executes in:
 - 44.36 ms for 160-bit key
 - 275.18 ms for 1024-bit key

Applications

- Mobile and wireless devices, PDAs
- Secure banking and web transactions
- ZigBee® technology and other monitoring and control applications
- Smart card readers
- Friend/foe identification
- Peripherals interoperating with TCG and NGSCB PCs

Cryptographic Functions

Cryptographic Algorithm	Applicable Specification	Cryptographic Function ⁽¹⁾	Security Strength (in bits)	Code Size ⁽²⁾ (bytes)
Primary Functions				
RSA	PKCS#1 v1.5	Encryption/Decryption	1024, 2048	2574
RSA	PKCS#1 v1.5	Signing/Verification	1024, 2048	2658
Diffie-Hellman	PKCS#3	Key Agreement Protocol	1024, 2048	2067
DSA	FIPS 186-2	Signing/Verification	1024	4341
Auxillary Functions				
Big Integer ⁽³⁾	–	Modulus Arithmetic Functions	–	927
		Inverse Modulus Arithmetic	–	495
		Montgomery Arithmetic	–	552
Deterministic	ANSI X9.82	Random Number Generator	–	1353
SHA-1	FIPS 180-2	Secure Hash Algorithm	160	912
MD5	RFC 1321	Message Digest MD5	128	1428

Notes: 1. Wrapper functions are used in combination with the underlying basic encryption and/or decryption functions for the respective algorithm (AES,T-DES).
 2. All library functions use the stack and require input and output message buffers to be set up by the calling application, stack usage is below 60 bytes of RAM.
 3. AES and T-DES data rate represents the average of the data rates for performing basic encryption and decryption functions for a single block of data.
 4. All data rate statistics shown here assume device operation of 40 MIPS.

Data Encryption Libraries (SW300052)

Summary

Microchip offers a reliable security solution for embedded applications built on the 16- and 32-bit microcontroller platform. This solution is provided by means of a single library. This library features the symmetric key encryption/decryption functions Advanced Encryption Standard (AES) and Triple-Data Encryption Algorithm (Triple-DES). These algorithms are also recommended by most Internet Engineering Task Force (IETF), Federal Information Processing Standards (FIPS) and IPSec standards.

Key Features

- Optimized for speed, code size and RAM usage
- Library functions tested for adherence to applicable standards
- Application note describing APIs
- Several examples of use are provided for each library function

Applications

- Web access
- E-mail
- Secure XML transactions
- Virtual Private Networks (VPN)
- Secure transfer of stored calibration data

Cryptographic Functions: 16-bit MCUs and DSCs

Cryptographic Algorithm	Applicable Specification	Cryptographic Function ⁽¹⁾	Code Size (bytes)	Data Rate ⁽²⁾ (Kbps)
T-DES	FIPS 46-3	Basic Encryption and Decryption	7500	19.8 (16 MIPS) 49.5 (40 MIPS)
AES (128-bit)	FIPS 197	Basic Encryption	3018	74.1 (16 MIPS) 184.7 (40 MIPS)

Notes: 1. Wrapper functions are used in combination with the underlying basic encryption and/or decryption functions for the respective algorithm (AES,T-DES).
2. AES and T-DES data rate represents the average of the data rates for performing basic encryption and decryption functions for a single block of data.

Cryptographic Functions: 32-bit MCUs

Cryptographic Algorithm	Cryptographic Function	CPU Cycle Times in μ Secs ^(1,2)	Throughput (Kbytes/Sec)
AES (128-bit)	Create Session Key	40.45	764
	Encrypt Block	20.45	
	Decrypt Block	20.45	
AES (128-bit)	Create Session Key	48.83	634.4
	Encrypt Block	24.63	
	Decrypt Block	24.63	
AES (128-bit)	Create Session Key	57.68	544.4
	Encrypt Block	28.70	
	Decrypt Block	28.70	

AES Library for PIC32 MCUs Memory Usage:
With MIPS32 Instructions: 14.9 KB
With MIPS16 Instructions: 13.9 KB

Notes: 1. Speed (Time) optimized -03 loops unrolled.
2. PIC32 MCU running at 80 MHz.

Summary

The dsPIC® DSC DSP Library provides a set of speed optimized functions for the most common digital signal processing applications. This library provides significant performance savings over equivalent functions coded in C and allows developers to dramatically shorten their development time. The dsPIC DSC DSP Library is written predominantly in Assembly language and makes extensive use of the dsPIC DSC DSP instruction set and hardware resources, including X and Y memory addressing, modulo addressing, bit-reversed addressing, 9.31 saturation and REPEAT and DO loops.

Key Features

- 49 total functions
- Full compliance with the Microchip MPLAB® C Compiler for PIC24 MCUs and dsPIC DSCs, assembler and linker
- Functions are both C and assembly callable
- FIR filtering functions include support for lattice, decimating, interpolating and LMS filters

- IIR filtering functions include support for canonic, transposed canonic and lattice filters
- FIR and IIR functions may be used with the filter files generated by the dsPIC® DSC Digital Filter Design Tool
- Transform functions include support for in-place and out-of-place DCT, FFT and IFFT transforms
- Window functions include support for Bartlett, Blackman, Hamming, Hanning and Kaiser windows
- Support for program space visibility
- Complete function profile information including register usage, cycle count and function size information

The dsPIC DSC DSP Algorithm Library provides functions for the following:

- Vector operations
- Matrix operations
- Filtering operations
- Transform operations
- Windows operations

Function	Cycle Count Equation	Conditions*	Number of Cycles	Execution Time @40 MIPS
16-bit Complex FFT**	–	N = 64	3739	93.5 µs
16-bit Complex FFT**	–	N = 128	8485	212.1 µs
16-bit Complex FFT**	–	N = 256	19055	476.4 µs
32-bit Complex FFT**	–	N = 64	14293	357.325 µs
32-bit Complex FFT**	–	N = 128	32781	819.525 µs
32-bit Complex FFT**	–	N = 256	74181	1854.525 µs
Single Tap FIR	–	–	1	25 ns
Block FIR	53 + N (4 + M)	N = 32, M = 32	1205	30.2 µs
Block FIR Lattice	41 + N (4 + 7M)	N = 32, M = 32	7337	183.5 µs
Block 16-bit IIR Canonic	36 + N (8 + 7S)	N = 32, S = 4	1188	29.7 µs
Block 32-bit IIR Canonic	43 + N (49 + 197S)	N = 32, S = 4	26827	670.7 µs
Block IIR Lattice	46 + N (16 + 7M)	N = 32, M = 8	2350	58.7 µs
Matrix Add	20 + 3 (C*R)	C = 8, R = 8	212	5.3 µs
Matrix Transpose	16 + C (6 + 3 (R - 1))	C = 8, R = 8	232	5.8 µs
Vector Dot Product	17 + 3N	N = 32	113	2.9 µs
Vector Max	19 + 7 (N-2)	N = 32	229	5.7 µs
Vector Multiply	17 + 4N	N = 32	145	3.6 µs
Vector Power	16 + 2N	N = 32	80	2.0 µs
Proportional Integral Derivative (PID)	30	N = 1	30	0.75 µs

*C = # columns, N = # samples, M = # taps, S = # sections, R = # rows
 **Complex FFT routine inherently prevents overflow.
 1 cycle = 25 nanoseconds @ 40 MIPS

Summary

Microchip's PIC32 DSP Library enables developers to add DSP capabilities to many applications by taking advantage of the highly optimized hardware features inside the PIC32 MCU, including its multiply-accumulate, math unit with parallel execution and two full sets of CPU registers. Additionally, this DSP Library's use of a RADIX-2 based FFT provides more options for sample size than the RADIX-4 designs. The PIC32 DSP Library allows users to select from the common 64-, 128-, 256-, 512- and 1024-point FFTs, as well as other sizes. The PIC32 DSP Library also includes support for 32-bit FFTs. PIC32 DSP Library is a part of Microchip's free DSP Library package in MPLAB C Compiler for PIC32 MCUs.

Key Features

- C callable DSP functions written in assembly using the standard MIPS DSP library APIs
- Easier FFT – eliminates setup function
- Complete function profile information including register usage, cycle count and function size information

FFT Benchmarks (Radix-2) Measured on PIC32 MCUs @ 80 MHz	
16-bit, 256 point	283 μ S
16-bit, 512 point	630 μ S
16-bit, 1024 point	1.39 mS
32-bit, 512 point	617 μ S

The PIC32 DSP Library provides functions for the following:

- 16- and 32-bit vector math
- Finite Impulse Response (FIR) Filter
- Infinite Impulse Response (IIR) Filter
- Least Mean Squares (LMS) Filter
- 16- and 32-bit Fast Fourier Transforms (FFTs)

PIC24 MCU/dsPIC® DSC Floating Point Math Library

Summary

The PIC24/dsPIC® DSC Math Library is the compiled version of the math library that is distributed with the highly optimized, ANSI-compliant MPLAB® C Compiler for PIC24 MCUs and dsPIC DSCs (SW006012). It contains advanced single and double-precision floating-point arithmetic and trigonometric functions from the standard C header file <math.h>. The library delivers small program code size and data size, reduced cycles and high accuracy.

Key Features

- The PIC24/dsPIC DSC Math Library is callable from either MPLAB C Compiler or PIC24/dsPIC DSC Assembly language
- The functions are IEEE 754 compliant, with signed zero, signed infinity, NaN (Not a Number) and denormal support and operated in the “round to nearest” mode
- Compatible with MPLAB ASM30 and MPLAB LINK30

Math Table

Function Group	Function	Performance (Cycles) ^(1, 2, 3)
Basic Floating Point	add	101
	sub	121
	mul	81
	div	197
Trigonometric and Hyperbolic	sinf	645
	sinhf	1817
	asinf	647
	cosf	634
	acosf	701
	coshf	3593
	tanf	2795
	tanhf	1070
	atanf	585
	atan2f	2719
Logarithmic and Exponential	logf	661
	log10f	713
	expf	617
	frexpf	39
	ldexpf	44
Power Functions	powf	7494
	sqrtf	492
Rounding Functions	floorf	128
	ceilf	199
Absolute Value Functions	fabsf	5
Modular Arithmetic Functions	fmodf	159
	modff	257

- Notes:**
1. Results are based on using the MPLAB C Compiler (SW006012) version 3.21 and represent an average.
 2. All performance statistics represented here are for 32-bit IEEE-754 floating-point input and output data types.
 3. Performance listed represent an average number of instruction cycles required to perform the floating-point operation.

PIC24 MCU/dsPIC® DSC Fixed Point Math Library

Summary

The Fixed Point Math library provides mathematical functions useful in for wide range of applications including Motor Control, Digital Power Control, Digital Signal Processing and General purpose real-time control using fractional data types. The Fixed Point math library includes over 65 general-purpose functions composed of twenty eight functions supporting Q15 math and thirty seven functions supporting Q16 math.

Key Features

- Integrated with MPLAB C Compiler for PIC 24 MCUs and dsPIC DSCs
- Q15 (0.15) and Q16 (15.16) formats are provided in library
- Q15 format supports numerical data ranges from -32768 to 32767
- Q16 format supports numerical data ranges from -2147483648 to 2147483647
- The IQ math functions are callable from both ‘C’ and Assembly



PIC32 MCU Floating Point Math Library

Summary

The optimized PIC32 Math Library is packaged within the MPLAB C Compiler for PIC32 MCUs. The floating-point math library provided with the compiler has been significantly optimized to take full advantage of the PIC32 MCU instruction set. Single-precision and double precision math library functions are now available, giving users a choice between double- and single-precision operations. The library provides the greatest benefit for the more complex operations offering a greater than 5x performance improvement over the previous versions of library for many operations.

Key Features

- 22 optimized math library functions for faster execution and less power consumption
- Available in single or double precision
- The functions are ANSI-89 compliant
- IEEE 754 Compliant

Math Table

Function	Description	Average Single Precision Performance (Cycles)	Time (μ s)**
sin/sinf*	Sin of a double/single precision floating point variable	299	3.7375
cos/cosf*	Cos of a double/single precision floating point variable	299	3.7375
tan/tanf*	Tan of a double/single precision floating point variable	389	4.8625
exp/expf*	Calculates the exponential function of a double/single precision floating point variable	133	1.6625
fabs/fabsf*	Calculates the absolute value of a double/single precision floating point variable	6	0.075
fmod/fmodf*	Calculates the remainder of x/y as a double/single precision floating point value	86	1.075
log/logf*	Calculates the log of a double/single precision variable	301	3.7625
sqrt/sqrtf*	Calculates the square root of a double/single precision variable	237	2.9625
pow/powf*	Calculates x raised to the power of y	367	4.5875
floor/floorf*	Calculates the floor of a double/single precision floating point variable	33	0.4125
ceil/ceilf*	Calculates the ceiling of a double/single precision floating point variable	34	0.425
asin/asinf*	Arc sin of a double/single precision floating point variable	618	7.725
acos/acosf*	Arc cos of a double/single precision floating point variable	685	8.5625
atan/atanf*	Arc tan of a double/single precision floating point variable	353	4.4125

*"f" denotes single precision floating point number.

** PIC32 MCU at 80 MHz.

A complete list of floating point math functions is available in the MPLAB® C32 C Libraries Manual.

PIC24 MCU/dsPIC® DSC Peripheral Library

Summary

The PIC24/dsPIC Digital Signal Controller (DSC) Peripheral Library provides a set of functions for setting up and controlling the operation of all the peripheral modules available in the PIC24 microcontrollers and dsPIC DSCs, as well as functions for interfacing with an external LCD.

Key Features

- A library file for each device from the PIC24/dsPIC DSC families, including functions corresponding to peripherals present in that particular device
- C include files that enable pre-defined constants for passing parameters to various library functions, as well as a file for each peripheral module
- Functions in pre-compiled libraries that may be called from an application program written in either MPLAB® C Compiler for PIC24 MCUs and dsPIC DSCs or PIC24/dsPIC DSC assembly languages
- C source code is included to customize functions to specific application requirements
- Pre-defined constants in the C include files eliminate the need to refer to the details and structure of every special function register, while initializing peripherals or checking status bits
- API Compatible with PIC32

The PIC24/dsPIC DSC Peripheral Library supports the following hardware peripheral modules:

- Timers
- Input capture and output compare
- Quadrature Encoder Interface (QEI)
- Power supply and motor control PWM
- Real-Time Clock Calendar (RTCC)
- Cyclic Redundancy Check (CRC)
- I/O ports and external interrupts
- Reset
- UART, SPI, I²C™
- Data Converter Interface (DCI)
- 10-bit/12-bit A/D converter
- Digital-to-Analog Converter (DAC)
- Analog comparator
- CAN
- Functions for controlling an external LCD through configurable I/O port pins are also provided
- Parallel master port

PIC32 MCU Peripheral Library

Summary

PIC32 Peripheral Library provides functions and macros for setting up and controlling the 32-bit peripherals. Applications wishing to use peripheral libraries need to include one single file in their source file <plib.h> to access any of the supported functions and macros.

The PIC32 Peripheral Library supports the following peripheral module functions:

- System level function
- Prefetch cache
- DMA
- Bus matrix function
- Reset/control, power saving functions
- Oscillator, timer, input capture/output compare
- I/O ports and external interrupts
- PMP function
- UART, SPI, I²C™, CAN, Ethernet and USB functions
- RTCC functions
- 10-bit/A/D converter
- Comparator
- CVREF
- Watchdog timer

Key Features

- Peripheral library is optimized for faster execution and lower code memory
- One single peripheral library file to access many peripheral module functions
- C include files that enable pre-defined constants for passing parameters to various library functions, as well as a file for each peripheral module
- Functions in pre-compiled libraries that may be called from an application program written in either MPLAB C Compiler for PIC32 MCUs or PIC32 assembly languages
- C source code is included to customize functions to specific application requirements
- Pre-defined constants in the C include files eliminate the need to refer to the details and structure of every special function register, while initializing peripherals or checking status bits
- API compatible with 16-bit devices

Microchip USB Framework

Summary

Microchip's USB software supports USB on 8-, 16- and 32-bit MCUs. This software is royalty free source code and also includes example projects. The 8-bit PIC18 family supports USB device mode. The 16-bit PIC24F, PIC24E and dsPIC33E and 32-bit PIC32 products with USB support device mode, embedded host and On-The-Go.

Key Features

- Supports 8-bit, 16-bit and 32-bit PIC® MCUs
- Includes related drivers and resources to use with PC
- Includes various demonstration examples
- Includes class driver examples for:
 - HID
 - Mass Storage
 - CDC
 - Audio
 - Printer
 - Charger
 - Custom



Applications

- USB mouse and keypad
- Thumb drive data logger
- Mass storage devices
- Printers
- Bar code scanner
- CDC serial emulator

Microchip Graphics Library

Summary

Microchip provides a complete graphics library that allows users to quickly and easily implement a Graphical User Interface (GUI) on small color touch screen displays. The complete graphics display solution that will enable designer to quickly evaluate a graphics display solution at minimal cost. Graphics library is highly modular and is optimized for Microchip's 16- and 32-bit microcontrollers (PIC24F, PIC24H/E, dsPIC33F/E and PIC32 MCUs).

Key Features

- Up to 16-bit or 65K colors
- 2D objects such as line, circle, text, rectangle, polygon, bar
- 3D objects such as buttons, panels, window, group box, slider
- Image, animation
- Resistive touch screen, keypad
- Multiple fonts

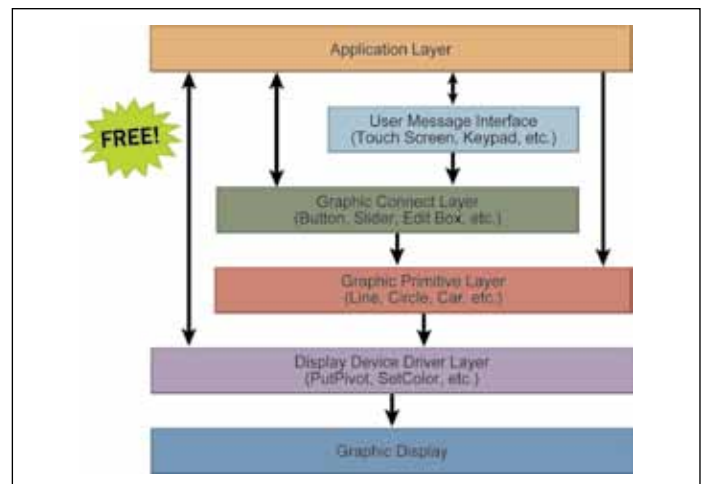

Applications

- MIMIC panels
- Hand-held devices
- Many other applications that require front-end graphics display

FREE Image Decoder Library

Summary

The Image decoder library supports the decoding of images in JPEG, BMP and GIF format in PIC24 and PIC32 MCUs and dsPIC DSC devices. This is a supplement to the Graphics Library but could be used stand alone. This library not only supports input data through Microchip's MDD file system but it can also be configured to support user specific inputs from ROM, external EEPROM, etc. The output can be sent to the graphics display through the driver provided with the graphics library or to a callback function where the user can further render the decoded image (even if graphics library is not used). The individual decoder provided uses the stack for the work memory, so additional memory is not needed.

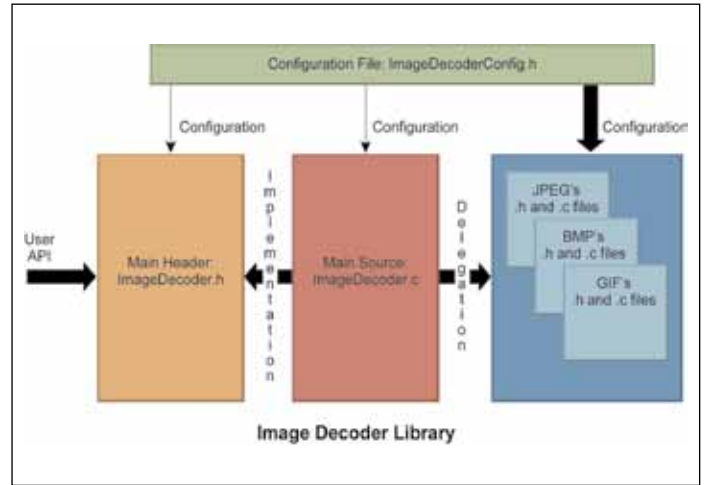

FREE dsPIC® DSC DTMF Generation/Detection Libraries

Summary

The dsPIC DSC DTMF Generation Library and DTMF Detection Library provide algorithms to generate and detect Dual Tone Multi-Frequency (DTMF) signals, in accordance with ITU-T Q.23 technical features of push button telephone set recommendations.

Library Resource Usage

Library	Data Memory (Bytes)	Program Memory (Bytes)	MIPS
dsPIC® DSC DTMF Generation Library	1K	4.0K	0.3
dsPIC DSC DTMF Detection Library	1.2K	6.2K	1.2

For ease of integration and customization, full source code is provided. In addition, sample application programs running on a dsPIC33F device and dsPICDEM.net™ development board are provided to demonstrate these libraries.

Applications

- Answering machines
- Public and private telephone exchanges
- Telephony and line test equipment
- Telephone equipment

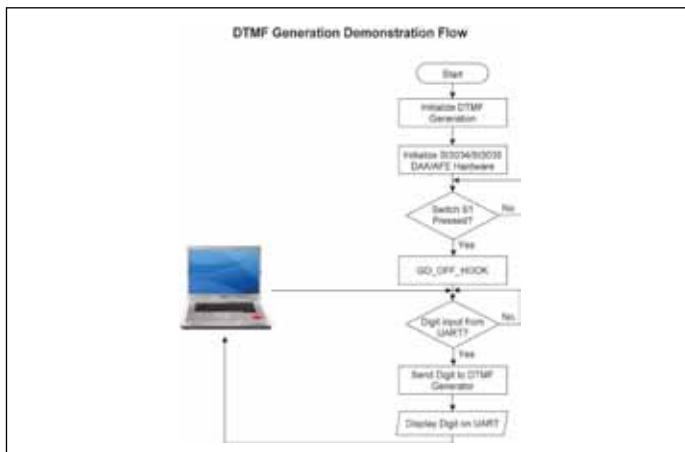
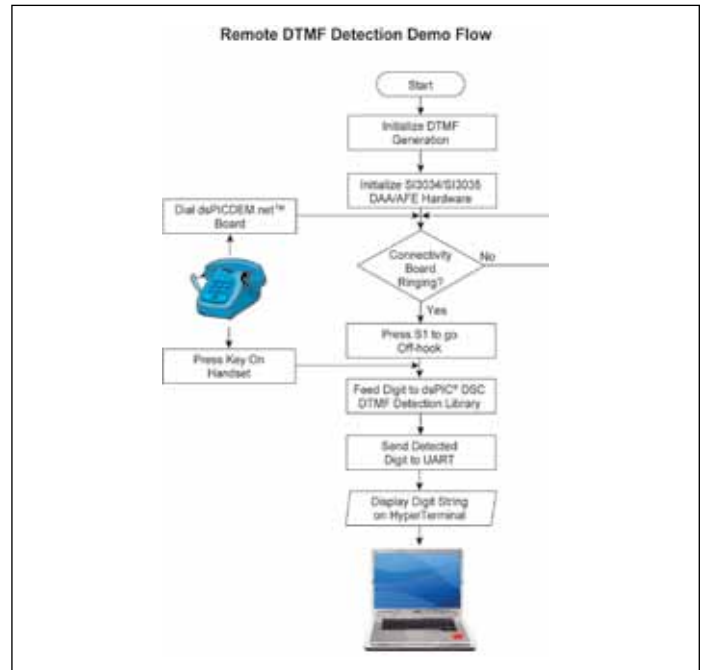

Microchip TCP/IP Stack

Summary

Communication over the Internet is accomplished by implementing the TCP/IP protocol. Microchip offers a free TCP/IP software stack that is optimized for the PIC18, 16-bit and 32-bit device family. The stack is a suite of programs that provide services to all TCP/IP based applications. Users do not need to know all the intricacies of the TCP/IP specifications in order to use the stack. Microchip's TCP/IP stack supports the PIC32MX6/7 32-bit MCU family with Ethernet MAC and the PIC18F97J60 family of 8-bit microcontrollers with Ethernet MAC and PHY and ENC28J60/ENC624J600 stand alone Ethernet controllers.

Key Features

- Socket support for TCP and UDP
- Portable across all PIC18, PIC24, dsPIC30F, dsPIC33F/E and PIC32MX products
- Support for MPLAB® C compilers
- RTOS independent
- Full TCP state machine
- Modular design

Supported Protocols

- | | |
|----------|-------------|
| ■ ARP | ■ IP |
| ■ ICMP | ■ UDP |
| ■ TCP | ■ SHOUTcast |
| ■ SNMP | ■ HTTP |
| ■ Telnet | ■ SNTp |
| ■ SMTP | ■ DNS |
| ■ DHCP | ■ FTP |
| ■ NBNS | ■ TFTP |



Additional Algorithm Support

- MD5 and SHA-1 Hashing
- MIME
- MPFS
- Base64
- Secure Random Number

Applications

- Streaming MP3 internet radio
- UART to TCP bridge
- Ethernet/Internet bootloader
- Web monitorable and configurable vending machine
- Remote sensor monitoring and control

FREE IEEE 802.11: WiFi®

Summary

Microchip has added 802.11 wireless communications to its lineup of wireless technologies for the embedded market. Microchip has a Wi-Fi PICTail™ development board that adds 802.11 capabilities to development platforms for the PIC18, PIC24 and PIC32 microcontroller families and dsPIC® DSCs. The PICTail development board contains the MRF24WB0MA FCC and Wi-Fi certified module.

Key Features

- Compatible with PIC18, PIC24 and PIC32 MCUs and dsPIC DSCs
- IEEE 802.11b compliant wireless solution compatible with b/g/n routers
- Supports infrastructure and ad-hoc networks
- MRF24WB0MA small footprint module integrated antenna, MAC, baseband, RF and power amplifier
- MRF24WB0MA/B module is FCC, IC, Wi-Fi certified, and ROHS, CE and ETSI compliant, providing considerable cost savings and quick time-to-market
- License free TCP/IP stack supporting standard suite of Internet Protocols
- Built-in EZConfig application to facilitate network provisioning without a keyboard or display



MRF24WB0MA WiFi® PICTail™/PICTail Plus Daughter Board (AC164136-4)

- Built-in ZeroConf (Bonjour, Avahi) application to simplify human interaction
- Supports WEP, WPA and WPA2 security protocols on module
- Solutions as simple as a single PIC® MCU plus WiFi module with power and passives

FREE IEEE 802.15.4: Microchip MiWi™ and MiWi P2P Protocol

Summary

MiWi™ and MiWi P2P are proprietary protocol stacks developed by Microchip for short-range wireless networking applications based on the IEEE 802.15.4™ wireless personal area network (WPAN) specification. The MiWi protocol stacks are optimized for low-power, low data rate, cost sensitive application and offer a small footprint alternative to the standard based ZigBee® compliant protocol stack. This protocol stack supports 8-, 16- and 32-bit PIC MCUs and dsPIC DSCs.

MiWi

- Microchip wireless proprietary protocol stack
- Based on IEEE 802.15.4 standard
- Small footprint, highly optimized Mesh and Star network protocol



Your wireless connectivity made simple.

MiWi P2P

- Microchip wireless proprietary peer-to-peer protocol stack
- Based on IEEE 802.15.4 standard
- Ultra-Small footprint (3 KB), Peer-to-Peer network protocol

Applications

- Data loggers
- Security systems
- Display controllers
- Photo display frames



IEEE 802.15.4: ZigBee® , ZigBee PRO and ZigBee Smart Energy Profile Suite

Summary

As a member of the ZigBee® Alliance, Microchip offers certified ZigBee Compliant Platform (ZCP) for the ZigBee 2006, ZigBee PRO and ZigBee Smart Energy Suite protocol stacks.

Key Features

ZigBee Smart Energy Profile Suite

- Support for the following Smart Energy devices:
 - Energy Service Portal (ESP)
 - Meter (MTR)
 - In Premise Display (IPD)
 - Load Control Device (LCD)
 - Programmable Communicating Thermostat (PCT)
 - Smart Appliance (SAP)
 - Range Extender (RED)
- Support for Certificate Based Key Exchange (CBKE) security mechanism
- The ZigBee Cluster Library (ZCL) (SE profile clusters only)
- Support for commissioning via the Startup Attribute Set (SAS)
- Portable across the PIC24, PIC32 MX MCUs and dsPIC® DSCs

ZigBee PRO

- Microchip's Certified ZigBee PRO Compliant Platform (ZCP)
 - Certified ZigBee PRO Stack
 - PIC24 MCUs or dsPIC DSC family of microcontrollers
 - MRF24J40, MRF24J40MA, MRF24J40MB 2.4 GHz IEEE 802.15.4 transceiver/modules
- Full featured, interoperable, Mesh and Star network protocol

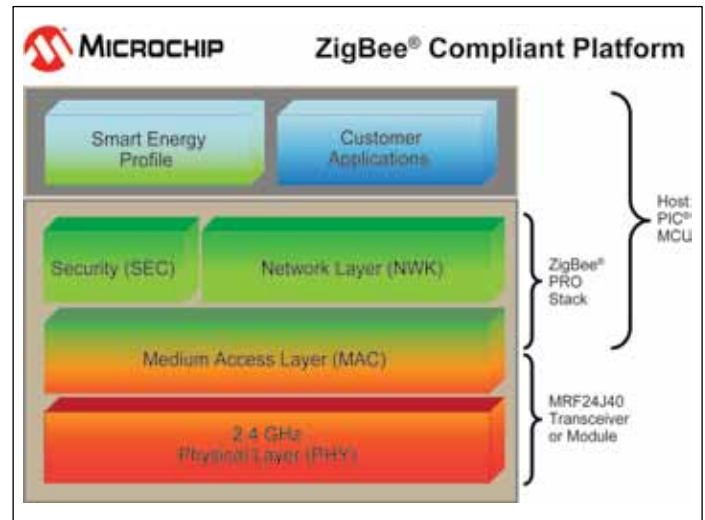

ZigBee 2006

- Zero-cost-license and royalty-free ZigBee 2006 protocol stack
- Microchip's Certified ZigBee 2006 Compliant Platform (ZCP)
 - Certified ZigBee 2006 Stack
 - PIC18 or PIC24 MCUs or dsPIC DSCs
 - MRF24J40, MRF24J40MA, MRF24J40MB 2.4 GHz IEEE 802.15.4 transceiver/modules
- Full featured, interoperable, Mesh and Star network protocol



PIC32 CAN Library Using MCP2515 CAN Controller*

Summary

PIC32 CAN library is based on the MCP2515 CAN controller. The MCP2515 is connected to the PIC32 microcontroller via SPI port. The Library provides seamless access to the CAN controller over the SPI bus.

Key Features

- Library provides enumerated interface
- Well-documented API functions
- The library supports 125 kbps, 250 kbps and 500 kbps bus speeds.
- The MCP2515 support max SPI clock speed of 10 MHz

Applications

- Automotive applications
- Data loggers
- Physical layer for custom communication protocols

*This library is not for use with PIC32 MCUs with integrated CAN controllers. The CAN APIs for integrated CAN controllers are available in the MPLAB® C Compiler.



Bluetooth® Stack for PIC24 and PIC32 MCUs and dsPIC® DSCs

Summary

Microchip has partnered with CandleDragon to offer the Bluetooth® software stack. The dotstack™ Bluetooth stack was designed for low cost and low power embedded devices. The Bluetooth stack is SIG compliant and has a small footprint.

Key Features

- Written in ANSI C
- Well defined protocols and profile application interface
- Supports Bluetooth specification version 1.2, 2.0, 2.1, +EDR
- Supported profiles: SPP, HID, HFP, Headset, Simple Secure Pairing, FTP, HDP and PBAP
- Bluetooth chipsets supported CSR



Microchip FAT File System for PIC24 and PIC32 MCUs and dsPIC® DSCs

Summary

Microchip's FAT file system interface library brings the ability to transfer and share portable memory devices between an embedded system and a personal computer. Most SD cards, CF cards and MultiMedia Cards (MMCs), particularly those sized below 2 GB, use the FAT16 standard. The FAT32 standard can be used to address memory sized between 2 GB and 2 TB. This library with complimentary application note provides a method to read and/or write to these storage devices through a microcontroller. The data of these storage devices can be read by a PC, and the data written by a PC can be read by a microcontroller. Most operating systems (i.e., Windows® XP) support the FAT16 and FAT32 file systems.

Key Features

- Based on ISO/IEC 9293 specifications
- Provides a method of interfacing to files and directories on FAT12, FAT16 and FAT32 file systems.
- FAT16 and FAT32 allow access to up to 2 GB and 2 TB of memory, respectively



PICtail™ Plus Daughter Board for SD and MMC Cards (AC164122)

- Most popular file system with SecureDigital (SD) cards, CompactFlash® (CF) cards and USB thumb drives
- Hardware evaluation supported by PICtail Plus® SD and MMC Daughter Card and USB PICtail Plus Daughter Card

FATFs File System for PIC32 MCUs

Summary

FATFs is an open source file system software stack designed for microcontrollers to easily access multiple media sources during run-time. This small footprint low-overhead software supports FAT32, FAT16 and FAT12 formats using an 8.3 file name format. FatFs can be modified to use multiple media sources (ATA, USD, SD Card, etc.). FatFs is an open source module that can be used, modified, and/or republished for personal, non-profit, education, R&D or commercial use without any restriction.

Key Features

- Large number of media drive support and easy drive addition
- Write buffer flushing
- Compile time options to minimize memory footprint
- Simultaneous multiple media access
- Application software control of file structure
- No pre-defined limit to the number of files structures that can be used

Data EEPROM Emulation for PIC18, PIC24 and PIC32 MCUs and dsPIC[®] DSCs Ref Application Note: AN1095 · Ready-to-Use Solution

Summary

Microchip has expanded its product portfolio to include a wide variety of cost-effective PIC[®] microcontrollers without an internal data EEPROM. Many applications store non-volatile information in the Flash program memory using table write and read operations. Applications that need to frequently update this data may have greater endurance requirements than the specified Flash endurance for the device. The alternate solution of using an external, serial EEPROM device may not be appropriate for cost-sensitive or pin-constrained applications. This application library presents a third alternative that addresses these issues. This algorithm features an interface similar to an internal data EEPROM, uses available program memory and can improve endurance by a factor as high as 500.

Key Features

- Easy to use application interface
- Memory sizes of 0 to 255 words per block
- Total EEPROM memory size limited only by Flash size
- Endurance increased by a factor of up to 500
- Endurance can be further increased by allocating additional program memory

Applications

- Applications which require to store user definable parameters
- Frequently updated calibration or adjustable parameters
- Saving critical data due to power failure



Memory Disk Drive File System for PIC18, PIC24 and PIC32 MCUs and dsPIC® DSCs

Summary

Microchip's Memory Disk Drive (MDD) file system interface library brings the ability to transfer and share portable memory devices between an embedded system and a personal computer. The MDD library provides a method to read and/or write to these storage devices through a microcontroller. The data of these storage devices can be read by a PC, and the data written by a PC can be read by a microcontroller. Most operating systems (i.e., Windows® XP) support the FAT16 and FAT32 file systems.

Key Features

- Based on ISO/IEC 9293 specifications
- Provides a method of interfacing to files and directories on FAT12, FAT16 and FAT32 file systems
- FAT16 and FAT32 allow access to up to 2 GB and 2 TB of memory, respectively
 - FAT16 standard used for most SecureDigital (SD) cards, CompactFlash® (CF) cards and MMCs MultiMedia Cards sized below 2 GB
 - FAT32 standard can be used to address memory sized between 2 GB and 2 TB



PICtail™ Plus Daughter Board for SD and MMC Cards (AC164122)

- Most popular file system with SD cards, CF cards and USB thumb drives
- Hardware evaluation supported by PICtail™ Plus SD and MMC Daughter Card (AC164122) and USB PICtail Plus Daughter Card (AC164131)
- MDD file system library supports the 8-bit PIC18 devices as well as the 16-bit PIC24F, PIC24H/E, dsPIC30 and dsPIC33 devices and 32-bit PIC32 devices



PMBus Stack

Summary

Microchip PMBus stack implements the PMBus protocol over the traditional I²C™ communication interface for dsPIC® SMPS Digital Signal Controllers from dsPIC33F “GS” family and Mid-Range PIC® microcontrollers from the PIC16F88X family. PMBus is an open standard protocol that was defined as a means of communication with power conversion and other devices, thus creating the first open communications standard in the world of digital control over power devices and systems. PMBus is a superset of the System Management Bus (SMBus™), an industry standard serial communication interface.

Key Features

- Modular software and easy integration with application code
- On/Off control
- Sequencing: event driven and time driven status reporting
- Fault management

Applications

- Communication between two power stages
- Communication interface for external world
- AC-DC power supply
- Isolated/Non isolated DC-DC power supply
- Power factor correction
- Fan controllers, temperature sensors



Class B Safety Software Library for PIC® MCUs and dsPIC® DSCs

Ref Application Note: AN1229 · Ready-to-Use Solution

Summary

The Class B Safety Software Library routine detects the occurrence of faults in a single channel CPU. These routines have been developed in accordance with the IEC 60730 standard to support the Class B certification process. These routines can be directly integrated with the end user's application to test and verify the critical functionalities of a controller without affecting the end user's application. Application Note, AN1229 describes the Application Programming Interface (API) functions that are available in the Class B Safety Software Library.

Key Features

The following tests can be implemented using this library:

- CPU register test
- Program counter test
- Variable memory test
- Invariable memory (Flash/EEPROM) test
- Interrupt test
- Clock test

Applications

- Automotive applications
- Home appliances
- Home security devices



mTouch™ Capacitive Touch Library

Summary

The mTouch software packages enables designers to easily integrate touch technologies into their application. It allows the implementation in a small dedicated controller as well as integrating the complete application in a single MCU. Separate packages are available depending on the microcontroller: mTouch PIC16F Framework, mTouch PIC18/24/32 or dsPIC libraries. Software package features include:

- Multiple demo projects:
 - Swiping gesture
 - Proximity detection
 - Direct key sensing
 - Matrix key sensing
 - 2-channel sliders
 - 4-channel sliders
- Graphics integration with keys (runs on DM240312 board)
- Interoperability with Microchip Graphics and USB libraries
- Demo projects can be run directly on the enhanced mTouch Capacitive Evaluation Kit.

Application Notes for Capacitive Touch

- Techniques for Robust Capacitive Touch Sensing, AN1334
- mTouch™ Metal Over Cap Technology, AN1325

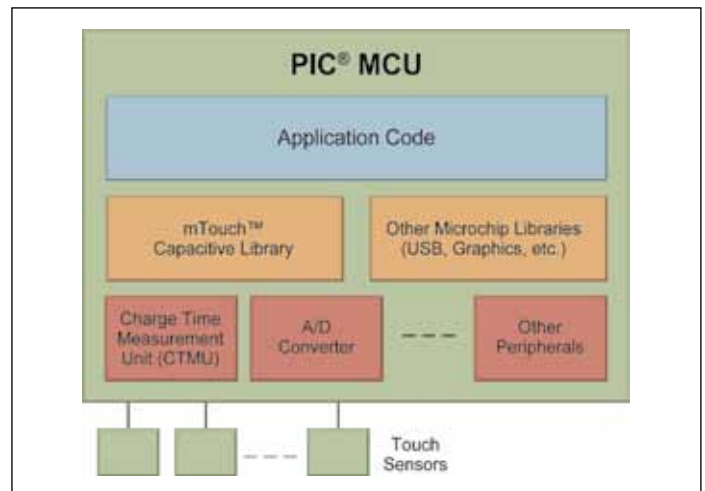

- mTouch Conducted Noise Immunity Techniques for CTMU Peripheral, AN1317
- Capacitive Touch Using Only an ADC (CVD) (suitable for PIC10/12/16/24H/32 MCUs and dsPIC DSCs), AN1298
- Microchip CTMU for Capacitive Touch Applications (suitable for PIC18 and PIC24F MCUs), AN1250
- Capacitive Touch Algorithm Simulation, AN1254



Consumer-band BPSK-based 7.2 kbps Powerline Soft Modem Demonstration Software

Summary

The Power Line Modem (PLM) PICtail™ Plus Daughter Board provides communication over power lines using a Binary Phase Shift Keying (BPSK) modulation scheme. These boards interface to the popular Explorer 16 Demo Board and operate in the consumer frequency band at a carrier frequency of 129.6 kHz. The software modem runs on the dsPIC33F DSC and utilizes an analog front end (AFE) to interface to the AC power mains.

Key Features

- Operates on 5V and 9V power supply
- Modulation and demodulation in software
- Software selectable baud rates: 1200, 2400, 3600, 4800, 5400 and 7200
- Variable transmit power level setting
- Compatible with 220V/50 Hz and 110V/60 Hz power lines



Consumer-band BPSK-based 7.2 kbps PLM PICtail™ Plus Daughter Board (AC164142)

The demonstration software provides all of the source code required to implement power line communication. In addition, there are also five different demos with example source code. Two consumer-band BPSK-based 7.2 kbps Powerline Soft Modems are included in this kit.

Application Solutions

Application	Document Title	Application Note Number
Motor Control	Sensorless BLDC Motor Control Using a dsPIC30F or dsPIC33F	AN901
	Using a dsPIC30F or dsPIC33F for Vector Control of an ACIM	AN908
	Sensored BLDC Motor Control Using a dsPIC30F or dsPIC33F	AN957
	Introduction to AC Induction Motor Control Using a dsPIC30F or dsPIC33F	AN984
	Using a dsPIC30F for Sensorless BLDC Motor Control	AN992
	Sinusoidal Control of PMSM Motors with dsPIC30F or dsPIC33F Devices	AN1017
	Sensorless Field-Oriented Control for PMSM Motors	AN1078
	Power Factor Correction Using dsPIC DSCs	AN1106
	Sensorless BLDC Control with Back EMF Filtering Using the Majority Function	AN1160
	Sensorless Field Oriented Control (FOC) of an AC Induction Motor (ACIM)	AN1162
	Sensorless Field Oriented Control (FOC) of an AC Induction Motor (ACIM) Using Field Weakening	AN1206
	Integrated Power Factor Correction (PFC) and Sensorless Field Oriented Control (FOC) System	AN1208
	Sensorless Field Oriented Control for a Permanent Magnet Synchronous Motor Using the PLL Estimator and Field Weakening	AN1292
	Single-Shunt Three-Phase Current Reconstruction Algorithm for Sensorless FOC of a PMSM	AN1299
	Stepper Motor Control with dsPIC DSCs	AN1307
Wired and Wireless Connectivity	Microchip TCP/IP Stack	AN833
	Using the C30 Compiler and the SPI Module to Interface EEPROMs with dsPIC33F and PIC24F Devices	AN1069
	IrDA® Standard Stack	AN1071
	Using the C30 Compiler to Interface Serial EEPROMs with dsPIC33F Devices	AN1100
	HTTP Server Using BSD Socket API for PIC32MX Devices	AN1107
	TCP/IP Stack with BSD Socket API for PIC32MX Devices	AN1108
	SNMP Agent Using BSD Socket API for PIC32MX Devices	AN1109
	FTP Server Using BSD Socket API for the PIC32MX Device	AN1111
	Using External Memory with PIC24F, PIC24H and dsPIC33F Devices	AN1210
	ZigBee® 2006 Protocol Stack	AN1232
	ECAN™ Operation with DMA on dsPIC33F and PIC24H Devices	AN1249
Digital Power	AC-DC Reference Design	User's Guide: DS70320 AN1114, AN1207
	Offline UPS Reference Design	AN1279
	Digital Power Interleaved PFC Reference Design	AN1278
Bootloader	Bootloader for dsPIC30F/33F and PIC24F/24H Devices	AN1094
	Serial Bootloader for PIC32 MCUs	AN851
	Serial Bootloader for PIC24F Devices	AN1157
Graphics	Graphics Display Solution	AN1136
	Using a Keyboard with the Microchip Graphics Library	AN1227
General Purpose	Data Encryption Routines for PIC24, dsPIC and PIC32 Devices	AN1044
	Implementing Digital Lock-In Amplifiers Using a dsPIC DSC	AN1115
	File I/O Functions Using Memory Disk Drive File System Library	AN1045
	Grid-Connected Solar Microinverter Reference Design Using a dsPIC DSC	AN1338
	Digital LED Lighting Development Kit	DM330014
	DC/DC LLC Converter Reference Design Using a dsPIC DSC	AN1336
	Quarter Brick DC/DC Converter Reference Design	–
	Porting the Helix MP3 Decoder onto Microchip's PIC32MX 32-bit MCUs	AN1367
	Automotive Headlamp HID Ballast Reference Design Using a dsPIC® DSC Device	AN1372



Sensorless BLDC Motor Control Using the dsPIC30F or dsPIC33F

Application Note: AN901 · Ready-to-Use Solution



Proven Software Source Code

Summary

Microchip provides a proven, fully functional and highly flexible solution for using the dsPIC30F/33F to control Brushless DC (BLDC) motors without Hall-effect position sensors. The software makes extensive use of dsPIC30F/33F peripherals for motor control. The algorithm implemented for sensorless control is particularly suitable for use on fans and pumps. The program is written in C and has been specifically optimized and well-annotated for ease of understanding and program modification/configuration.

Capabilities of this Application Solution

- Current control and speed control modes
- Back EMF zero-crossing routine precludes the need for position sensing components
- Good transient response
- Can run the motor as low as 200 RPM
- Supports braking features
- Remote control through UART
- Program code size: 15 KB of program Flash memory
- RAM size: 276 bytes of data RAM memory

DMCI Graphical Data Display

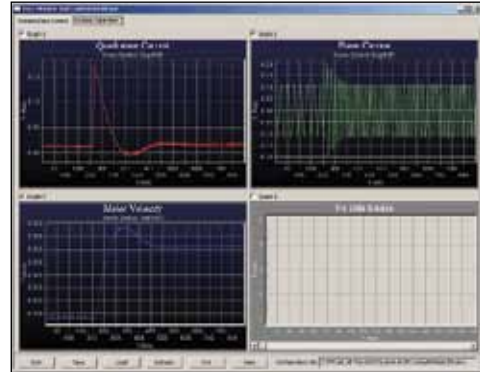

**dsPICDEM™ MCLV
Development Board
(DM330021)**



**dsPICDEM™ MCHV
Development Board
(DM330023)**



Using a dsPIC30F or dsPIC33F for Vector Control of an ACIM

Application Note: AN908 · Ready-to-Use Solution



Proven Software Source Code

Summary

Microchip's AC Induction Motor (ACIM) vector control solution is written for the dsPIC30F/33F family of devices. The software makes extensive use of dsPIC30F/33F peripherals for motor control. The software implements vector control of an ACIM, using the indirect flux control method. The program is written in C and has been specifically optimized and well annotated for ease of understanding and program modification.

Capabilities of this Application Solution

- 50 µs control loop period
- Requires approximately 9 MIPS of CPU usage (less than one-third of the total available CPU)
- Optional diagnostic mode can be enabled to allow real time observation of internal program variables on DMCI/RTDM
- Easy control loop adjustment through DMCI/RTDM
- Program code size: 8 KB of program Flash memory
- RAM size: 512 bytes of data RAM memory

DMCI Graphical Data Display

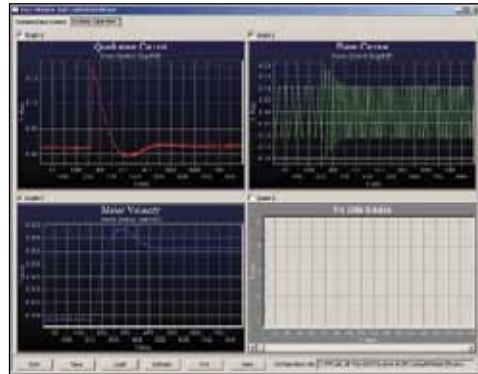

dsPICDEM™ MCHV Development Board (DM330023)

Sensored BLDC Motor Control Using a dsPIC30F or dsPIC33F

Application Note: AN957 · Ready-to-Use Solution



Proven Software Source Code

Summary

Microchip provides a fully working and highly flexible solution to control Brushless DC (BLDC) motors with Hall-effect position sensors. The software makes extensive use of dsPIC30F/33F peripherals for motor control. The program is written in C and has been specifically optimized and well annotated for ease of understanding and program modification.

Capabilities of this Application Solution

- Source code provides both open-loop control and closed-loop control algorithms
- Potentiometer for speed control
- Program code size: 2 KB of program Flash memory
- RAM size: 180 bytes of data RAM memory



dsPICDEM™ MCLV Development Board (DM330021)



dsPICDEM™ MCHV Development Board (DM330023)

Introduction to AC Induction Motor Control Using a dsPIC30F or dsPIC33F

Application Note: AN984 · Ready-to-Use Solution

 **Proven Software Source Code**

Summary

This application solution demonstrates how to use the dsPIC30F/33F to control an AC Induction Motor (ACIM). The solution presented requires a basic understanding of ACIM characteristics and is based on the dsPICDEM™ MCHV Development Board. The program is written in assembly code and has been specifically optimized and well annotated for ease of understanding and program modification. It provides basic variable speed control of an ACIM in open-loop Volts/Hertz mode.



**dsPICDEM™ MCHV
Development Board
(DM330023)**

Capabilities of this Application Solution

- Supports sinusoidal waveforms for motor drive
- Provides volts-hertz drive operation for various torque profiles
- Program code size: 1200 bytes of program Flash memory
- RAM size: 86 bytes of data RAM memory

Using a dsPIC30F for Sensorless BLDC Motor Control

Application Note: AN992 · Ready-to-Use Solution

 **Proven Software Source Code**

Summary

This application note provides a fully working and highly flexible solution for using the dsPIC30F2010, dsPIC30F3010 or dsPIC30F4012 to control BLDC sensorless motors without mechanical position sensors. The software makes extensive use of dsPIC30F peripherals for motor control. The algorithm implemented for sensorless control is particularly suitable for use on fans and pumps. The program is written in C and has been specifically optimized and well annotated for ease of understanding and programming.



**PICDEM™ MC LV
Motor Control Development
Board (DM183021)**

Capabilities of this Application Solution

- Based on Application Note AN901
- Uses a potentiometer to select the motor speed
- A user interface is available to provide control of up to 45 control parameters
- Program code size: 10 Kbytes of program Flash memory
- RAM size: 300 bytes of data RAM memory

Sinusoidal Control of PMSM Motors with dsPIC30F or dsPIC33F/E Devices

Application Note: AN1017 • Ready-to-Use Solution

Proven Software Source Code

Summary

Application note AN1017 provides a fully working and highly flexible solution for using the dsPIC® Motor Control DSCs to control Brushless DC (BLDC) motors with the use of Hall-effect position sensors and sinusoidal commutation. The software makes extensive use of dsPIC30F/dsPIC33F/E peripherals for motor control. The program is written in C and has been specifically optimized and well annotated for ease of understanding and program modification.

Capabilities of this Application Solution

- Potentiometer for speed control
- Sinusoidal control with Space-Vector Modulation (SVM)
- Optimized PID implementation
- Program code size: 2 KB of program Flash memory
- RAM size: 180 bytes of data RAM memory



**dsPICDEM™ MCLV
Development Board
(DM330021)**



**dsPICDEM™ MCHV
Development Board
(DM330023)**

Sensorless Field-Oriented Control for PMSM Motors

Application Note: AN1078 • Ready-to-Use Solution

Proven Software Source Code

Summary

The implementation of advanced, cost-effective motor control is made easy with dsPIC® Digital Signal Controllers (DSCs). This solution presents a Sensorless FOC control for PMSM motors and helps to develop energy efficient air conditioners, washing machines and other home appliances.

Capabilities of this Application Solution

- Position and speed estimation using slide mode controller
- Low cost current sensing using two shunt resistors
- 8 kHz and 20 kHz PWM switching frequency
- Implementation on dsPIC30F and dsPIC33F/E family of products
- Angle estimation compensation
- Field weakening enables higher speed operation
- Three PI control loops for speed and current components for torque and flux
- Program code size: 6 Kbytes
- RAM used: 0.5 Kbytes
- CPU usage: 11 MIPS with control loops at 8 kHz, and 21 MIPS with 20 kHz control loops



**dsPICDEM™ MCLV
Development Board
(DM330021)**



**dsPICDEM™ MCHV
Development Board
(DM330023)**

Power Factor Correction Using dsPIC® DSCs

Application Note: AN1106 • Ready-to-Use Solution

Proven Software Source Code

Summary

Many applications in the areas of motor control, power control, Uninterruptible Power Supplies (UPS) and Switched Mode Power Supplies (SMPS) demand a stable, regulated DC power source with reduced input current harmonic content and better power factor. The application solution describes the efficient Average Current Mode Control using a dsPIC® DSC to implement Power Factor Correction (PFC).

Capabilities of this Application Solution

- Power factor correction up to 0.99
- Implementation using output compare or motor control PWM modules
- Implementation on dsPIC30F and dsPIC33F family of products
- Voltage feed forward compensator implementation to improve stability
- Voltage and current PI control loops for better dynamic response



**dsPICDEM™ MCHV
Development Board
(DM330023)**

- User configurable switching frequency, default frequency of 80 kHz
- Synchronization of PWM and ADC allowing low cost current sensing
- Program code size: 2 Kbytes
- RAM used: 142 bytes
- CPU usage: 10 MIPS

Sensorless BLDC Control with Back EMF Filtering Using a Majority Function

Application Note: AN1160 • Ready-to-Use Solution

Proven Software Source Code

Summary

This application note describes a sensorless Brushless Direct Current (BLDC) motor control algorithm that is implemented using a dsPIC33F/E DSC. The algorithm works utilizing a majority function for digitally filtering the Back-Electromotive Force (BEMF). Each phase of the motor is filtered to determine when to commutate the motor drive voltages. This control technique excludes the need for discrete, low-pass filtering hardware and off-chip comparators.

Capabilities of this Application Solution

- Sensorless motor control
- Simple and easy to implement and lower board cost
- Can run the motors at very low speed
- Majority function helps to improve transient response of motor
- Majority detect algorithm greatly eases motor tuning process



**dsPICDEM™ MCLV
Development Board
(DM330021)**

Sensorless Field Oriented Control (FOC) of an AC Induction Motor (ACIM)

Application Note: AN1162 · Ready-to-Use Solution

 **Proven Software Source Code**

Summary

Where efficiency and low cost control of the induction motor drive is a concern, the sensorless Field Oriented Control (FOC), also known as vector control provides the best solution. This application note provides a solution for sensorless Field Oriented Control (FOC) of induction motors using a dsPIC33F/E DSC.

Capabilities of this Application Solution

- FOC control of AC induction motor provides an improved transient response
- Sensorless FOC reduces cost of hardware and increases reliability
- FOC algorithm maintains a tighter control on performance of motor and hence preferred over simple V/F control
- Use of PLL estimator enables very low speed of operation of motor
- Improves efficiency of the system and reduces disturbances on the supply line



**dsPICDEM™ MCHV
Development Board
(DM330023)**

Sensorless Field Oriented Control (FOC) of an AC Induction Motor (ACIM) Using Field Weakening

Application Note: AN1206 · Ready-to-Use Solution

 **Proven Software Source Code**

Summary

This application note describes sensorless Field oriented control with field weakening of an AC Induction motor using a dsPIC® Digital Signal Controller (DSC). This application note is an extension of AN1162: *Sensorless Field Oriented Control (FOC) of an AC Induction Motor (ACIM)*.

Capabilities of this Application Solution

- FOC control of AC induction motor provides an improved transient response
- Sensorless FOC reduces cost of hardware and increases reliability
- FOC algorithm maintains a tighter control on performance of motor and hence preferred over simple V/F control
- Use of PLL estimator enables very low speed of operation of motor
- Improves efficiency of system and reduce disturbance on supply line
- The motor can be run at speeds higher than nominal values



**dsPICDEM™ MCHV
Development Board
(DM330023)**

Integrated Power Factor Correction (PFC) and Sensorless Field Oriented Control (FOC) System

Application Note: AN1208 • Ready-to-Use Solution

 **Proven Software Source Code**

Summary

This dsPIC33F/E application note describes the process of integrating two complex applications: PFC and Sensorless FOC. Harmonic content in input current can be reduced by implementing Power Factor Correction and efficient control of a motor can be realized using Sensorless Field Oriented Control (FOC) techniques. These applications are implemented on a Permanent Magnet Synchronous Motor (PMSM). In addition, this application notes also describes the integration of algorithms, lists the necessary hardware requirements and provides guidelines to optimize the development procedure.

Capabilities of this Application Solution

- PFC Implemented to improve overall efficiency
- Reduced harmonics
- FOC control of AC induction motor provides an improved transient response



**dsPICDEM™ MCHV
Development Board
(DM330023)**

- Sensorless FOC reduces cost of hardware and increases reliability
- FOC algorithm maintains a tighter control on performance of motor and hence preferred over simple V/F control
- Uses a SMO estimator which is more tolerant to motor parameter variations than a PLL
- Improves efficiency of system and reduces disturbance on supply line

Sensorless Field Oriented Control for Permanent Magnet Synchronous Motor Using a PLL Estimator and Field Weakening

Application Note: AN1292 • Ready-to-Use Solution

 **Proven Software Source Code**

Summary

This dsPIC33F/E application note presents a sensorless Field Oriented Control (FOC) for Permanent Magnet Synchronous Motor (PMSM) using a PLL type estimator. The novelty of this sensorless control approach is the speed and angle estimator implementation, with a simple but robust and versatile design, making it suitable for most of the PMSM motors. The estimation requires only two current shunts measurement, while the FOC assures separate control of torque and field current components – permitting Field Weakening (FW) technique to be applied.

Capabilities of this Application Solution

- Use of PLL estimator enables very low speed of operation of motor
- Sensorless FOC reduces cost of hardware and increases reliability



**dsPICDEM™ MCLV
Development Board
(DM330021)**



**dsPICDEM™ MCHV
Development Board
(DM330023)**

- FOC algorithm maintains a tighter control on the performance of motor
- Use of field weakening extends the usable speed range of PMSM

Single-Shunt Three-Phase Current Reconstruction Algorithm for Sensorless FOC of a PMSM

Application Note: AN1299 · Ready-to-Use Solution

FREE Proven Software Source Code

Summary

This dsPIC33F/E application note describes a motor control technique where a single-shunt resistor circuit is used to measure the motor phase current. The algorithm reconstructs all three phase currents which are then used to estimate the rotor position in Sensorless Field Oriented Control (FOC) of Permanent Magnet Synchronous Motors (PMSM). This algorithm also corrects the PWM waveforms to compensate for the changes made to take the phase current readings.

Capabilities of this Application Solution

- Lowest-cost FOC sensorless PMSM solution
- Optimized torque response and energy efficiency benefits of FOC
- Trades off sensor cost for a slight decrease in efficiency



dsPICDEM™ MCLV Development Board (DM330021)



dsPICDEM™ MCHV Development Board (DM330023)

Stepper Motor Control with dsPIC® DSCs

Application Note: AN1307 · Ready-to-Use Solution

FREE Proven Software Source Code

Summary

This application note describes how to drive a stepper motor with a dsPIC33F/E motor control family DSC. PWM outputs are used to control both unipolar and bipolar stepper motors. Full stepping, half-stepping or variable micro-stepping is supported, in open or closed loop mode with a variety of decay modes. The application note software includes a MPLAB IDE DMC1 /RTDM file that providing an easy to use GUI for selecting the stepping mode, open or closed loop operation, the decay mode and a “step to position” command.

Capabilities of this Application Solution

- Supports both unipolar and bipolar motor operation
- Open loop control (fixed current or fixed voltage)
- Closed loop PI current control
- Full-, half- and micro-stepping modes
- Supports multiple decay modes (fixed/alternating)
- Stepper motor control user GUI included



dsPICDEM™ MCSM Development Board (DM330022)

dsPICDEM™ MCSM Development Board	DM330022
dsPICDEM™ MCSM Stepper Motor Development Board Kit	DV330021

Microchip TCP/IP Stack

Application Note: AN833 • Ready-to-Use Solution

Proven Software Source Code

Summary

There is nothing new about implementing TCP/IP (Transmission Control Protocol/Internet Protocol) on Microchip microcontrollers. Interested developers can easily find many commercial and non-commercial implementations of TCP/IP for Microchip products.

This application note details Microchip's own freely available implementation of the TCP/IP Stack. The Microchip TCP/IP Stack is a suite of programs that provides services to standard TCP/IP-based applications (HTTP Server, Mail Client, etc.), or can be used in a custom TCP/IP-based application.

The Microchip TCP/IP Stack is implemented in a modular fashion, with all of its services creating highly abstracted layers. Potential users do not need to know all the intricacies of the TCP/IP specifications to use it. In fact, those who are only interested in the accompanying HTTP Server application do not need any specific knowledge of TCP/IP.

Using the C30 Compiler and the SPI Module to Interface EEPROMs with dsPIC33F and PIC24F Devices

Application Note: AN1069 • Ready-to-Use Solution

Proven Software Source Code

Summary

The 25XXX series serial EEPROMs are SPI compatible and have maximum clock frequencies ranging from 3 MHz to 20 MHz. The SPI module available on dsPIC33F DSCs and PIC24F MCUs provides a very easy-to-use interface for communicating with the 25XXX series devices.

The largest benefit of using the SPI module is that the signal timings are handled through hardware rather than software. This allows the firmware to continue executing while communication is handled in the background. This also means that an understanding of the timing specifications associated with the SPI protocol is not required in order to use the 25XXX series devices in designs.

IrDA® Standard Stack

Application Note: AN1071 • Ready-to-Use Solution

 **Proven Software Source Code**

Summary

Infrared communication is a low-cost method of providing wireless, point-to-point communication between two devices. A wide variety of devices implement the IrDA standard specification, including computers, printers, PDAs, cell phones, watches and other instruments. AN1071 implements a complete IrDA® Standard Stack on Microchip's PIC24F, PIC24H and PIC32 microcontrollers and dsPIC30F and dsPIC33F DSCs. With the free source code these low-cost microcontrollers, with their built-in IrDA standard support, provide an inexpensive solution with plenty of computing power.

Capabilities of this Application Solution

The stack layers perform the following functions:

- Driver
- Framer



**IrDA PICTail™ Plus
Daughter Board (AC164124)**

- IrLAP (Infrared Link Access Protocol)
- IrLMP (Link Management Protocol)
- IAS (Information Access Service)
- TinyTP (Tiny Transport Protocol)
- IrCOMM 3-wire raw
- IrCOMM 9-wire cooked
- OBEX

Using the C30 Compiler to Interface Serial EEPROMs with dsPIC33F Devices

Application Note: AN1100 • Ready-to-Use Solution

 **Proven Software Source Code**

Summary

The 24XXX series serial EEPROMs are I²C™ compatible and have maximum clock frequencies ranging from 100 kHz to 1 MHz. The I²C module available on the dsPIC33F family of Digital Signal Controllers (DSC) provides a very easy-to-use interface for communicating with the 24XXX series devices. However, there are instances when the hardware peripheral cannot be used.

This application note is intended to serve as a reference for communicating with Microchip's 24XXX series of serial EEPROMs using the dsPIC33F family of devices when the I²C module is not available. This applications note describes a software implementation to use any two I/O pins for I²C communications. Source code for common data transfer modes is also provided. The source code is easily transferable to the PIC24 family of devices.



**dsPIC33 GP 100P to 100P
TQFP Plug-In Module
(MA330011)**



**Explorer 16
Development Board
(DM240001)**

HTTP Server Using BSD Socket API for PIC32MX Devices

Application Note: AN1107 • Ready-to-Use Solution

 **Proven Software Source Code**

Summary

An embedded HTTP (Hyper Text Transfer Protocol) server, or web server is an excellent addition to any network-enabled device. HTTP server capability allows an embedded device to be monitored and controlled remotely using any standard, off-the-shelf Internet browser. Owing to the ubiquitous deployment of Internet browsers, a web-enabled device can be accessed from almost any computer – desktop or mobile. This Microchip HTTP server application note and the included FAT16 module, supplemented by the TCP/IP Application Note AN1108, *Microchip TCP/IP Stack with BSD Socket AP*, provide an HTTP server module that can be integrated with almost any application on a PIC32 microcontroller.

Capabilities of this Application Solution

- Provides portability across the 32-bit family of PIC® microcontrollers
- HTTP Server APIs compatible with PIC18/PIC24 Microchip HTTP Server APIs
- Supports multiple HTTP connections
- Automatic interaction with the FAT16 file system



PIC32 Ethernet Starter Kit (DM320004)

- Supports the HTTP methods: GET, HEAD, POST and PUT
- Supports “continue” response that may be requested by the client
- Supports a modified Common Gateway Interface (CGI) to invoke predefined functions from within the remote browser
- Supports dynamic web page content generation
- Supports HTTP web page authentication

TCP/IP Stack with BSD Socket API for PIC32MX Devices

Application Note: AN1108 • Ready-to-Use Solution

Summary

This application note describes the Microchip TCP/IP stack with BSD (Berkley Socket Distribution) Socket API and provides the socket library for Internet TCP/IP communications. Many popular operating systems and many commercial TCP/IP stacks support BSD socket API. With a common programming interface, applications can now be ported easily across completely different platforms. For example, network applications written for a PC environment can also be compiled in an embedded environment, provided the embedded platform supplies the BSD library API. The demo applications included with this application note provide example client and server applications that use stream socket.

Capabilities of this Application Solution

- Creating client/server applications in an embedded environment
- TCP/IP stack components and design
- Socket functions included in the API



PIC32 Ethernet Starter Kit (DM320004)

- Application can be a server or a client, or both
- Full duplex communication
- Stream and datagram socket support
- IP address resolution done in background
- Can be used with or without a kernel/RTOS

SNMP Agent Using BSD Socket API for PIC32MX Devices

Application Note: AN1109 • Ready-to-Use Solution

 **Proven Software Source Code**

Summary

This Microchip SNMP agent application note and the included FAT16 module, supplemented by the TCP/IP application note AN1108, *Microchip TCP/IP Stack with BSD Socket API*, provide an SNMP agent that can be integrated with almost any application on a Microchip 32-bit microcontroller products. The TCP/IP application note and the FAT16 module are required to compile and run the SNMP agent module. The software in the installation files includes a sample application that demonstrates all of the features offered by this SNMP agent module.

Capabilities of this Application Solution

- Provides portability across the 32-bit family of PIC® microcontrollers
- SNMP agent APIs (Application Program Interfaces) are compatible with PIC18/24 SNMP agent APIs
- Functions independently of RTOS or application
- Supports MPLAB® C32 C Compiler
- Supports SNMP version 1 over UDP
- Supports Get, Get-Next, Set and Trap PDUs
- Automatically handles access to constant OIDs



PIC32 Ethernet Starter Kit (DM320004)

- Supports up to 255 dynamic OIDs and unlimited constant OIDs
- Supports sequence variables with 7-bit index
- Supports enterprise-specific trap with one variable information
- Uses an MIB that can be stored using FAT16
- Includes a PC-based MIB compiler
- Does not contain built-in TCP/UDP/IP statistics counters (user application must define and manage the required MIB)

FTP Server Using BSD Socket API for PIC32MX Devices

Application Note: AN1111 • Ready-to-Use Solution

 **Proven Software Source Code**

Summary

An embedded FTP (File Transfer Protocol) server is an excellent addition to any network-enabled device. FTP server capability facilitates the uploading of files to, and downloading of files from, an embedded device. Almost all computers have, at the very least, a command line FTP client that will allow a user to connect to an embedded FTP server. This Microchip FTP server application note and the included FAT16 module, supplemented by the TCP/IP application note AN1108, *Microchip TCP/IP Stack with BSD Socket API*, provide an FTP Server module that can be integrated with almost any application on a Microchip 32-bit microcontroller product.

Capabilities of this Application Solution

- Provides portability across all 32-bit PIC® microcontrollers
- FTP Server APIs are compatible with PIC18 and PIC24 Microchip FTP Server APIs
- FTP connection is authenticated by your application
- Automatic interaction with the FAT16 file system



PIC32 Ethernet Starter Kit (DM320004)

- Upload files to the server using the PUT command
- Download file to the client using the GET command
- Supports the FTP NOOP command
- Supports the PORT command, allowing you to change the data port
- FTP Server APIs compatible with older Microchip FTP Server APIs

Using External Memory with PIC24F, PIC24H and dsPIC33F Devices

Application Note: AN1210 • Ready-to-Use Solution

Proven Software Source Code

Summary

This application note describes the methodology to use the Parallel Master Port (PMP) module to interface with external data memory; either external Flash or external RAM. This document also lists the APIs and describes how to implement different types of interfaces. Using the PMP module, the memory devices with 64K locations (Kbytes or K words) can be interfaced with no extra I/Os and software. This application note describes how to interface the memory devices with more than 64K locations using some I/O pins and provides the required APIs.

Capabilities of this Application Solution

- External data memory interface overview
- Functional implementation
- Expansion of external memory
- Reference code

ZigBee® 2006 Protocol Stack

Application Note: AN1232 • Ready-to-Use Solution

Proven Software Source Code

Summary

The ZigBee® protocol is a wireless network protocol specifically designed for low data rate sensors and control networks. There are a number of applications that can benefit from the ZigBee protocol including, but not limited to: building automation networks, home security systems, industrial control networks, remote metering and PC peripherals. When compared against other wireless protocols, the ZigBee wireless protocol offers low complexity, reduced resource requirements and, most importantly, a standard set of specifications. It also offers three frequency bands of operation along with a number of network configurations and optional security capability.

Capabilities of this Application Solution

- A certified ZigBee 2006 compliant platform
- Support for the 2.4 GHz frequency band
- Support for all ZigBee protocol device types (coordinators, routers and end devices)
- Implements nonvolatile storage for the Group table and other critical network parameters such as neighbor and routing tables
- Portable across many of the PIC18 and PIC24 families of microcontrollers
- RTOS and application independent

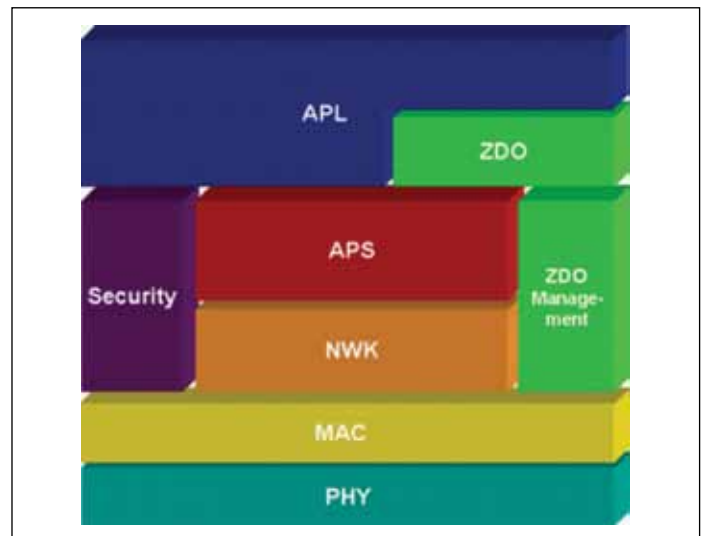

- Out-of-box support for Microchip MPLAB® C Compiler for PIC18 MCUs (formerly MPLAB C18 C Compiler) and MPLAB C Compiler for PIC24 MCUs and dsPIC® DSCs (formerly MPLAB C30 C Compiler)
- Support for multicast addressing
- Support for the end device rejoin mechanism for the PIC24H/E MCU and dsPIC33F/E DSC families

ECAN™ Operation with DMA on dsPIC33F and PIC24H Devices

Application Note: AN1249 • Ready-to-Use Solution

 **Proven Software Source Code**

Summary

This application note is focused on helping designers understand the role of Direct Memory Access (DMA) in implementing the functionality of the Enhanced Controller Area Network (ECAN™) module. The ECAN module works in conjunction with the DMA controller in dsPIC33F/E and PIC24H/E devices. The DMA controller allows data transfer from RAM to a peripheral and vice versa without any CPU assistance, and operates across its own data bus and address bus with no impact on CPU operation.



**Explorer 16
Development Board
(DM240001)**



**CAN/LIN PICtail Plus
Daughter Board
(AC164130-2)**

AC-DC Reference Design

User's Guide DS70320, Application Notes: AN1114 & AN1207 • Ready-to-Use Solution

 **Proven Software Source Code**

Summary

This reference design provides an easy method to evaluate the performance and features of SMPS dsPIC® DSCs for high wattage AC-DC conversion application. Discover the many benefits of digital power control implementation in this reference design. The SMPS AC-DC Reference Design unit works with universal input voltage range, and produces multiple DC outputs.

Capabilities of this Application Solution

- Operates at universal input voltage (85-265 VAC, 45-65 Hz)
- Operates up to 300W sustained output
- Full load operation on 3.3V and 5V outputs when loaded individually and/or simultaneously
- Power factor performance of 0.99 at full load (110 VAC/220 VAC)
- Fault indication and protection
- Excellent dynamic load performance and output sequencing



**Digital Power AC/DC
Reference Design**

- Modular and optimized software design
- Separate boards, one for digital signals (signal board) and the other for the power stages (power board)
- Signal board has two dsPIC33F16GS504 devices controlling different power stages

Offline UPS Reference Design

Application Note: AN1279 • Ready-to-Use Solution

 **Proven Software Source Code**

Summary

The application note describes the design of an Offline Uninterruptible Power Supply (UPS) using a Switch Mode Power Supply (SMPS) dsPIC® Digital Signal Controller (DSC). This reference design demonstrates how digital-power techniques when applied to UPS applications enable easy modifications through software, the use of smaller magnetics, intelligent battery charging, higher efficiency, compact designs, reduction in audible and electrical noise via a purer sine-wave output, USB communication and low-cost overall bill of materials.

Capabilities of this Application Solution

- High-frequency design
- Input Range AC
 - 95-135V, 60 Hz (110V design)
 - 210-242V, 50 Hz (220V design)
- Output Voltage AC
 - 110V @ 60 Hz (110V design)
 - 230V @ 50 Hz (220V design)
- Rating
 - 1000 VA steady-state output power
 - 1350 VA peak power (surge)



Digital Pure Sine Wave UPS Reference Design

- 36V battery input
- Adjustable charging current
- Efficiency of 84%
- Pure sine wave output with THD <3%
- Mains to battery transfer time < 10 ms
- Supports crest factor of 3:1
- Fault indications
- USB communication with PC
- LCD front panel

Digital Power Interleaved PFC Reference Design

Application Note: AN1278 • Ready-to-Use Solution

 **Proven Software Source Code**

Summary

The application note describes the design of an Digital Power Interleaved PFC (IPFC) using a Switch Mode Power Supply (SMPS) dsPIC® Digital Signal Controller (DSC). This reference design provides an easy method to evaluate the performance and features of SMPS dsPIC DSCs for an Interleaved Power Factor Correction application. The Interleaved PFC reference design unit works with universal input voltage range, and produces a single high voltage DC output up to 350W of power.

Capabilities of this Application Solution

- Operates at universal input voltage (85-265 VAC, 45-65 Hz)
- Operates up to 350W sustained output
- Output voltages up to 400 VDC



Digital Power Interleaved PFC Reference Design

- Power factor correction of 0.998 at full load and 120 VAC input
- Current Total Harmonic Distortion (ITHD) of 3% at full load and 120 VAC input
- Fault protection

Bootloader for dsPIC30F/33F and PIC24F/24H Devices

Application Note: AN1094 • Ready-to-Use Solution

Proven Software Source Code

Summary

The bootloader for dsPIC30F/33F and PIC24H/24F devices is used to load a user application on the target device without using external programmer. The bootloader consists of two applications:

1. Target side bootloader application which must be programmed into dsPIC30F/33F or PIC24F/24H program memory prior to bootloader operation.
2. Host PC bootloader application which communicates with the target side bootloader.

Capabilities of this Application Solution

Communication channels for firmware upgrade include: UART, SPI, I²C™, CAN, Ethernet, USB etc. The example in this application note uses the UART channel.

Serial Bootloader for PIC32 MCUs

Ref Application Note: AN851 • Ready-to-Use Solution

Proven Software Source Code

Summary

The serial bootloader for PIC32 MCUs is used to program the user application to the Program Flash Memory (PFM) using the UART serial port. The software comes with a PC application that reads the user provided HEX file and writes the program flash contents to the PIC32. This PC application works in conjunction with the bootloader (BL) firmware installed on the PIC32 MCU.

Capabilities of this Application Solution

- RS-232 based
- Auto baud detection
- Checksum validation of application code
- Bootloader located in protected Flash
- Graphical user interface provided
- Application code is located exclusively in program Flash
- Simple development system

Serial Bootloader for PIC24F Devices

Ref Application Note: AN1157 • Ready-to-Use Solution

 **Proven Software Source Code**

Summary

The serial bootloader for 16-bit PIC24F devices uses the UART module as a communication channel. The bootloader application uses the communication protocols originally outlined in Application Note AN851, *A Flash Bootloader for PIC16 and PIC18 Devices*. Some modifications to the original protocol have been made to maintain compatibility with the PIC24 architecture. It has also been redesigned to accommodate the current generation of PIC24FJ Flash microcontrollers, as well as the next generation of PIC24F devices.

Graphics Display Solution

Application Note: AN1136 • Ready-to-Use Solution

 **Proven Software Source Code**

Summary

This application note describes How to Use Widgets in the Microchip Graphics Library and also acts as a guide to the use of Microchip's graphics display solution which consists of the Explorer 16, a Graphics PICtail™ Plus (AC164127) daughter card, and a free Graphics Library. The graphics display solution allows a designer to quickly implement a graphical user interface on a display. The library also includes the software need to quickly implant a touch screen display, turning the display into a modern user interface.

Capabilities of this Application Solution

- Up to 16-bit or 65K colors
- 2D objects such as line, circle, text, rectangle, polygon, bar
- 3D objects such as buttons, panels, window, group box, slider
- Image, animation
- Resistive touch screen, keypad
- Multiple fonts

Graphics Screen Display



Graphics PICtail™ Plus Daughter Board with 3.2" Display Kit (AC164127-3)

Using a Keyboard with the Microchip Graphics Library

Application Note: AN1227 • Ready-to-Use Solution

Proven Software Source Code

Summary

Graphics displays are widely used in many applications and the number of products with displays is steadily growing. A primary reason is that a Graphical User Interface (GUI) can greatly simplify the use of a device. The GUI can interface a display with a variety of input devices, such as keyboards, touch screens or mice. Keyboards range from devices with several side buttons to those enabling text entry. Low cost and the ability to quickly enter data result in frequent use of keyboards.



Graphics PICtail™ Plus Daughter Board with 3.2" Display Kit (AC164127-3)

Data Encryption Routines for PIC24 and PIC32 MCUs and dsPIC DSCs

Application Note: AN1044 • Ready-to-Use Solution

Proven Software Source Code

Summary

Currently, there are three data encryption standards approved for use in the Federal Information Processing Standards (FIPS). This application note discusses the implementation of two of these for PIC24, dsPIC30/33 and PIC32 devices: Triple Data Encryption Standard (TDES) and Advanced Encryption Standard (AES). Source code for this application note (Part Number SW300052) is available from Microchip for a nominal fee.

Capabilities of this Application Solution

- Optimized for speed, code size and RAM usage
- Library functions tested for adherence to applicable standards
- Application note describes APIs
- Several examples of use are provided for each library function
- All Microchip 16-bit families supported

Cryptographic Algorithm	Applicable Specification	Cryptographic Function*	Code Size (bytes)	Data Rate (Kbytes/sec)
T-DES	FIPS 46-3	Basic Encryption and Decryption	7500	19.8 (16 MIPS) 37.2 (30 MIPS)
AES (128-bit)	FIPS 197	Basic Encryption	3018	74.1 (16 MIPS) 138.9 (30 MIPS)

*AES and T-DES data rate represents the average of the data rates for performing basic encryption and decryption functions for a single block of data.

Implementing Digital Lock-In Amplifiers Using a dsPIC® DSC

Application Note: AN1115 • Ready-to-Use Solution

Proven Software Source Code

Summary

Conventionally, lock-in amplifiers use complicated (and expensive) analog circuitry to perform the phase sensitive detection and filtering. However, modern DSCs, such as the dsPIC30F and dsPIC33F families, can be used to remove large amounts of the analog circuitry by performing the necessary operations in software. This capability provides a number of additional benefits including increased reliability, resistance to temperature and aging effects, and the ease with which the system can be modified in the field. By using the built-in signal processing capabilities of the dsPIC33F, it is possible to perform high-speed, high-accuracy measurements on sensors such as strain gauges. The same technique can be applied to other noisy systems such as capacitive sensors or the measurement of modulated light levels.

Capabilities of this Application Solution

- Useful for measuring small signals
- Avoids noise introduced at DC and low frequencies
- Measures signal changes caused by devices with complex impedances, such as capacitive sensors
- Signal processing is performed in the digital domain
- Minimum external components

File I/O Functions Using Memory Disk Drive File System Library

Application Note: AN1045 • Ready-to-Use Solution

Proven Software Source Code

Summary

Application note AN1045 covers the implementation of a memory disk drive file system on Microchip's 16-bit families. This memory disk drive file system allows a designer to easily implement a removable Flash-based media card of up to 2 GB into their application. Applications that require data logging or retrieval of large blocks of data such as fonts or bit maps are often taking advantage of removable Flash-based memory cards. The memory disk drive file system library is modular and provided in "C" source to easily integrate into any application.

Capabilities of this Application Solution

- Developed based on ISO/IEV9293 specification
- Known as FAT16 File System used on early DOS operating systems by Microsoft® Corporation
- Most popular files system with SD cards, CF cards and USB thumb drives
- Provides directory manipulation support
- Provides file/directory search support



PICtail™ Plus Daughter Board for SD and MMC Cards (AC164122)

- Easy-to use standard I/O style functions
- Available free for use on Microchip microcontrollers
- Portable across PIC18 and PIC24 MCUs and dsPIC® DSC devices
- Supports up to 2 GB

Digital LED Lighting Development Kit

Summary

Microchip's Digital LED Lighting Development Kit (DM330014) enables designers to quickly leverage the capabilities and performance of the dsPIC33 'GS' series of Digital Signal Controllers (DSCs), to develop LED lighting products. The dsPIC33 'GS' DSC and this reference design allow developers to create a 100% digitally controlled ballast function, while including advanced features such as dimming and color hue control. The dsPIC33 'GS' DSCs can support an entire system implementation for LED lighting products, including power-conversion circuits, such as AC-to-DC and DC-to-DC conversion, along with functions such as Power Factor Correction (PFC), which are necessary for a complete product and lower the overall system cost.

Benefits offered by the digital-power techniques in this reference design and the dsPIC33 'GS' series of DSCs include:

- Reduced system cost via higher integration
- Higher efficiency using digital-control techniques
- Flexible and reusable designs
- Advanced features implemented in software



Digital LED Lighting Development Kit (DM330014)

Key Features

- Color control for RGB LEDs
- Supports DMX512 Standard for brightness control
- Flexible input voltage support, including both buck and boost topologies
- Fully dimmable
- Full digital control
- Fault protection
- Fully controlled with a single dsPIC33FJ16GS504 DSC
- Supports dsPIC33F devices

Automotive Headlamp HID Ballast Reference Design Using a dsPIC[®] DSC

Application Note: AN1372 • Ready-to-Use Solution

Proven Software Source Code

Summary

In recent years, High Intensity Discharge (HID) lamps have been accepted as a good lighting source for automotive headlight applications. However, the startup process of an automotive HID lamp is complex. It consists of six stages and each stage presents different characteristics, which need different control strategies. A digitally controlled ballast has many advantages over the traditional analog approach.

Key Features

- Convenient implementation of sophisticated control algorithms
- High performance operation
- Effective protection
- Very robust
- Low cost

This application note focuses on the implementation of an automotive HID electronic ballast using a Microchip GS-series 16-bit Digital Signal Controller (DSC).

Digital Reference Design Automotive HID Ballast

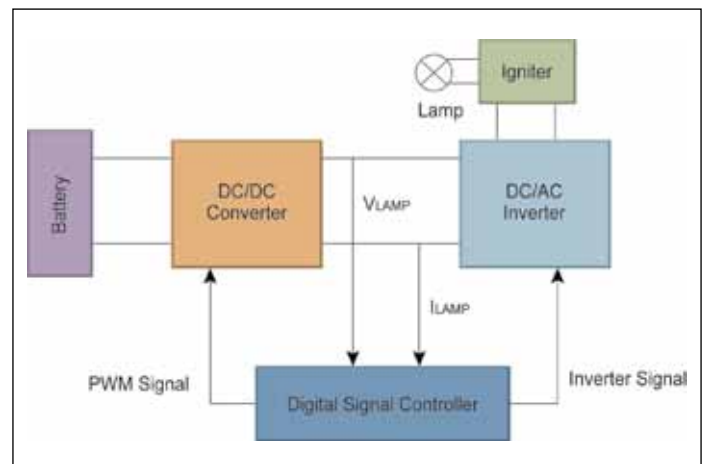

Grid-Connected Solar Micro Inverter Reference Design Using a dsPIC® DSC

Application Note: AN1338 • Ready-to-Use Solution

 **Proven Software Source Code**

Summary

This reference design demonstrates the flexibility and power of SMPS dsPIC Digital Signal Controllers in grid connected power conversion systems. This reference design works with any photovoltaic (PV) panel of maximum 220 Watts having open circuit voltage between 25V to 55 VDC. This reference design ensures maximum power tracking for PV panel voltage between 25V to 45 VDC. Two versions of this reference design are available to support 110V and 220V grid.

Key Features

- Peak efficiency of 94%
- Output current THD < 5%
- Power factor >0.95
- Maximum power point tracking
- Grid voltage and frequency tracking



Grid Connected Solar Micro Inverter Reference Design

- Protection against various current and voltage faults
- System islanding to detect grid failure
- Full digital control
- Supports dsPIC33F devices

DC/DC LLC Converter Reference Design Using a dsPIC® DSC

Application Note: AN1336 • Ready-to-Use Solution

 **Proven Software Source Code**

Summary

Microchip's 200W DC/DC LLC Resonant Converter Reference Design operates over a wide input voltage range (350-420 VDC) with a nominal input of 400V, providing a 12 VDC output, while maintaining high-voltage isolation between the primary and secondary. High efficiency is achieved through Zero Voltage Switching (ZVS) on the half-bridge converter and Zero Current Switching (ZCS) on the synchronous rectifier. A synchronous rectifier is implemented over the traditional full wave rectifier for improved efficiency. The reference design utilizes Microchip's digital power conversion dsPIC® DSC for unique "adaptive" control of the half-bridge converter and synchronous rectifier.

This reference design is implemented using a single dsPIC33F "GS" digital-power DSC that provides full digital control of the power conversion and system management functions. As shown in this reference design the dsPIC33F 'GS' device enable designers to easily and cost effectively create products using advanced switching techniques such as LLC that lower switching losses and enable efficiencies as high as 95%. The DC-DC LLC Converter Reference Design is royalty free when used in accordance with the licensing agreement.



DC/DC LLC Converter Reference Design

Key Features

- Low power consumption at no load
- Programmable soft-start
- Voltage, current, temperature monitoring and protection
- Primary and secondary MOSFET control
- Full digital control

Quarter Brick DC/DC Converter Reference Design

Ready-to-Use Solution

 **Proven Software Source Code**

Summary

Microchip's Quarter Brick DC/DC Converter Reference Design provides an easy method to evaluate the power, and features of SMPS dsPIC® Digital Signal Controllers in high density quarter brick DC-DC converters for Intermediate Bus Architectures (IBA). This reference design is implemented using a single dsPIC33F "GS" digital-power DSC that provides the full digital control of the power conversion and system management functions. As shown in this reference design, the dsPIC33F 'GS' device enable designers to easily and cost effectively create products using advanced switching techniques such as Phase Shift Full Bridge (PSFB) topology that lower switching losses and enable efficiencies as high as 94%. The Quarter Brick DC/DC Converter Reference Design is royalty-free when used in accordance with the licensing agreement.

Key Features

- Primary and secondary MOSFET control
- Active current share
- Remote ON/OFF



Quarter Brick DC/DC Converter Reference Design

- Programmable soft start
- Controlled fall time
- Voltage, current, temperature monitoring and protection
- Configurable output voltage
- Full digital control
- Supports dsPIC33F devices

Porting the Helix MP3 Decoder onto Microchip's PIC32MX 32-bit MCUs

Application Note: AN1367 • Ready-to-Use Solution

 **Proven Software Source Code**

Summary

This application note describes the procedure to port the open source Helix MP3 decoder algorithm onto Microchip's PIC32MX 32-bit microcontrollers (MCUs). The source code provided with this document demonstrates a MP3 player application using the Helix MP3 decoder. The MP3 player application uses Microchip's USB stack to read MP3 files from a USB flash drive (thumb drive), and the Microchip graphics stack to implement a Graphical User Interface (GUI) with touch screen support.

The Helix MP3 decoder is available as both floating point and fixed point implementations. The fixed point implementation is considered for porting the algorithm onto the PIC32MX microcontroller. The algorithm runs on any 32-bit fixed point processor and is coded entirely in the C language with options to replace certain code sections with optimized assembly instructions.

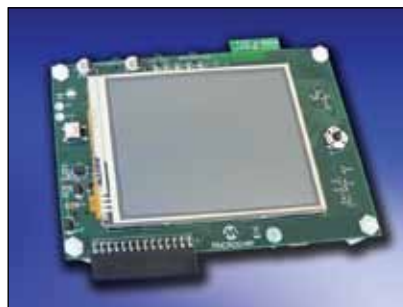

Multimedia Expansion Board (DM320005)

The Helix MP3 decoder provides Layer 3 support for MPEG-1, MPEG-2 and MPEG-2.5. It supports variable bit rates, constant bit rates and stereo and mono audio formats.

Software and Application Development Tools

Software and Application Development Tool	Part Number	List Price
MPLAB® IDE (Integrated Development Environment) Tools	SW007002	Free
MPLAB ICD In-Circuit Debugger	DV164035	\$189.99
MPLAB REAL ICE™ In-Circuit Emulator	DV244005	\$499.98
PICkit™ 3 In-Circuit Debugger	PG164130	\$44.95
MPLAB PM3 Universal Device Programmer	DV007004	\$895
MPLAB C Compiler for PIC24 MCUs and dsPIC® DSCs	SW006012	\$895
MPLAB C Compiler for PIC32 MCUs*	SW006015	\$895
dsPICworks™ Data Analysis and DSP Software	SW300021	Free
Digital Filter Design Digital Filter Design Lite	SW300001 SW300001-LT	\$249 \$29
Real-Time Data Monitoring Tool	MPLAB Plug-in	Free
dsPIC DSC Speech and Audio Fast Forward (SAFF) Tool	Included in MPLAB C Compiler	Free
Microchip Graphics Display Designer	Included in MPLAB C Compiler	Free
nanoWatt XLP Battery Life Estimator	MPLAB Plug-in	Free
Google PowerMeter Reference Implementation	-	Free

*MPLAB Compiler in LITE mode and Standard Eval Version are available for free download.

MPLAB® IDE (Integrated Development Environment) Tools

Summary

All of Microchip's MCU and DSC tools operate cohesively under the MPLAB IDE umbrella. The powerful and easy-to-use MPLAB IDE includes a host of free software components for fast application development and super-charged debugging. MPLAB IDE integrates not only software, but all of Microchip's hardware tools and many third party tools.

Key Features

- Project build and management
- Source level debug in ASM and C
- Flexible watch windows
- Searchable trace buffers
- Mouse over variable inspection
- Version control integration
- MATLAB Device Blocks for MPLAB IDE (for dsPIC30 and dsPIC33 DSCs)
- Real-time data monitoring
- Supports ALL 600+ MCUs and DSCs

Available for MPLAB IDE



Assembler/Linker/Librarian

The MPLAB ASM30 is a full-featured macro assembler. User defined macros, conditional assembly and a variety of assembler directives make the MPLAB ASM30 a powerful code generation tool.



MPLAB SIM Software Simulator

The MPLAB SIM Software Simulator is a full-featured, cycle accurate software simulator. In addition to simulating the CPU and the instruction set, it also supports key peripherals.

MATLAB/Simulink Device Blocks for dsPIC3X

The Microchip Device Blocksets for MATLAB Simulink provide a set of interface-compliant configuration and run-time peripheral blocks for the dsPIC30 and dsPIC33 DSCs. Complete applications can be created in the form of a MATLAB/SIMULINK model using blocksets provided by Microchip and Simulink. C code for the application will be generated. These blocksets are compatible with the MATLAB plug-in available in MPLAB IDE.

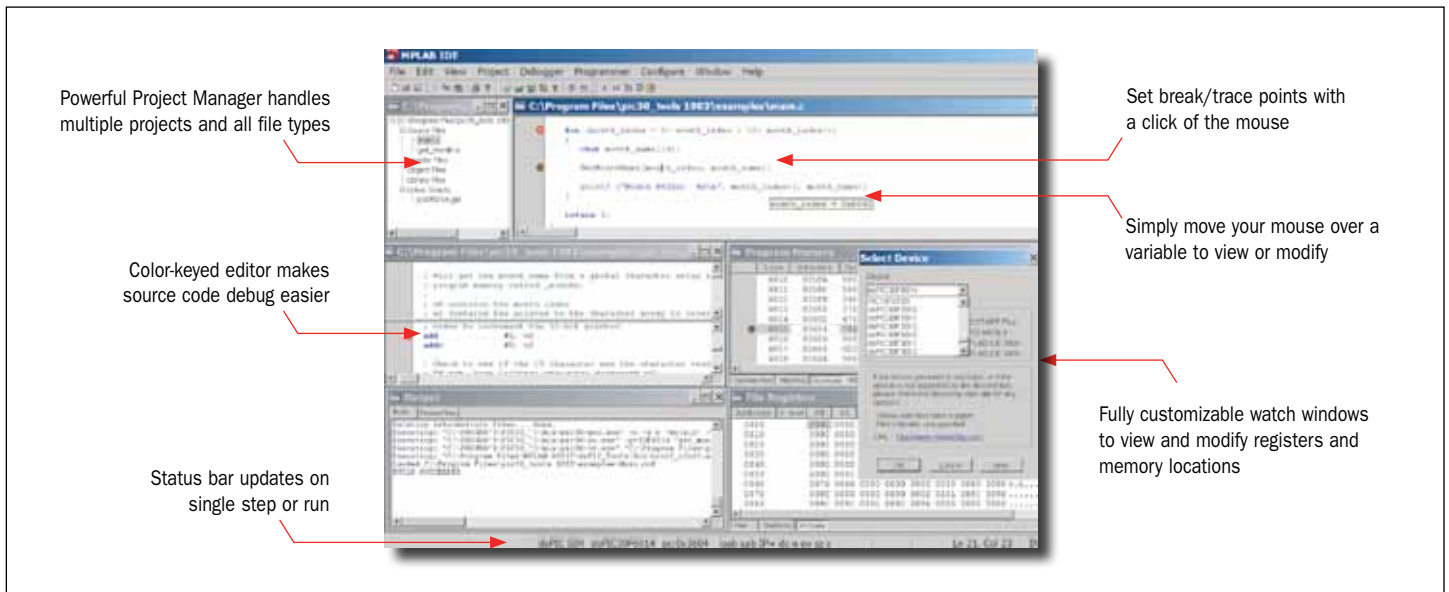

MPLAB® ICD In-Circuit Debugger (DV164035)

Summary

MPLAB® ICD In-Circuit Debugger System is Microchip's most cost effective high-speed hardware debugger/programmer for Microchip Flash Digital Signal Controller (DSC) and microcontroller (MCU) devices. It debugs and programs PIC® MCUs and dsPIC® DSCs with the powerful, yet easy-to-use graphical user interface of MPLAB Integrated Development Environment (IDE).

The MPLAB ICD In-Circuit Debugger probe is connected to the design engineer's PC using a high-speed USB 2.0 interface and is connected to the target with a connector compatible with the MPLAB ICD or MPLAB REAL ICE™ systems (RJ-11). MPLAB ICD supports all emulation headers.

Key Features

- Real-time debugging
- Ruggedized probe interface
- Microchip standard connectivity
- Portable, USB-powered and RoHS-Compliant
- High speed programming
- Low voltage emulation
- Test interface module
- Ease of maintenance and feature upgrade
- Low cost
- Powerful debugging



Products Supported

MPLAB ICD In-Circuit Debugger/Programmer supports most Flash PIC MCUs and dsPIC DSCs. For the current list of supported parts, review the latest release notes. The firmware is regularly updated to add support for new devices. As new device firmware is released, it can be downloaded with the latest version of MPLAB IDE, free of charge.

MPLAB® REAL ICE In-Circuit Emulator (DV244005)

Summary

MPLAB REAL ICE In-Circuit Emulator System is Microchip's high-speed emulator for Microchip Flash DSC and MCU devices. It debugs and programs PIC® microcontrollers and dsPIC® DSCs with the easy-to-use but powerful graphical user interface of the MPLAB Integrated Development Environment (IDE), included with each kit.

The MPLAB REAL ICE probe is connected to the design engineer's PC using a high-speed USB 2.0 interface and is connected to the target with either a connector compatible with the popular MPLAB ICD system (RJ11) or with the high-speed, noise tolerant, low voltage differential signal (LVDS) interconnection (CAT5).



Key Features

- Real-time execution and real time trace collection
- Stopwatch
- Real-time watch
- Full hardware debugging: breakpoints, single-step, variable inspect/modify
- Logic probe inputs/outputs (8)
- I/O port trace and SPI trace options for high-speed upload of trace data
- Over voltage/short-circuit monitor protection
- Low voltage: to 2.0 volts (2.0V to 5.5V range)
- High-speed USB 2.0 communication protocol

MPLAB REAL ICE offers the following advantages

- Low cost
- Full speed emulation
- Fast debugging and programming
- Ruggedized probe interface
- High speed connectivity (high-speed option)
- Long cable interconnects (validated to 3 meters)
- MPLAB IDE integration (included free)
- Small footprint (3 3/8" x 4 5/8" x 3/4")

PICKit™ 3 In-Circuit Debugger (PG164130)

Summary

The PICKit In-Circuit Debugger allows debugging and programming of Flash PIC® MCUs and dsPIC® DSCs at an affordable price point using the powerful MPLAB Integrated Development Environment (IDE) graphical user interface. The PICKit ICD is connected to the design engineer's PC using a full speed USB interface and can be connected to the target via a Microchip debug (RJ-11) connector (compatible with MPLAB ICD and MPLAB REAL ICE™). The connector uses two device I/O pins and a reset line to implement in-circuit debugging and In-Circuit Serial Programming™.

Key Features

- USB (Full speed 12 Mbits/s interface to host PC)
- Real-time execution
- MPLAB IDE compatible (free copy included)
- Built-in over-voltage/short circuit monitor
- Firmware upgradeable from PC/web download
- Totally enclosed
- Supports low voltage to 2.0 volts (2.0V to 6.0V range)
- Diagnostic LEDs (power, busy, error)
- Read/write program and data memory of microcontroller
- Erase of program memory space with verification
- Freeze-peripherals at breakpoint
- Program up to 512 KB Flash with the Programmer-to-Go



MPLAB® PM3 Universal Device Programmer (DV007004)

Summary

The MPLAB® PM3 Universal Device Programmer is easy to use and operates with a PC or as a stand-alone unit. This development tool programs Microchip's entire line of PIC® MCUs as well as the latest dsPIC® DSC devices. When used standalone, data can be loaded and saved with the SD/MMC card.



Key Features

- RS-232 or USB interface
- Integrated In Circuit Serial Programming™ (ICSP™) interface
- Fast programming time
- Three operating modes:
 - PC host mode for full control
 - Safe mode for secure data
 - Standalone mode for programming without a PC
- Complete line of interchangeable socket modules to support all Microchip devices and package options (sold separately)
- SQTPSM serialization for programming unique serial numbers while in PC host mode.
- An alternate DOS command line interface is available for batch control
- Supports PROMATE® II socket modules via adapter (sold separately)
- Large easy-to-read display
- Field upgradable firmware allows quick new device support
- Secure Digital (SD) and Multimedia Card (MMC)
- Buzzer notification for noisy environments

MPLAB® C Compiler for PIC24 MCUs and dsPIC® DSCs (SW006012)

Summary

The MPLAB® C Compiler for PIC24 MCUs and dsPIC® DSCs (also known as MPLAB C30) is a full-featured ANSI-compliant C compiler for Microchip's 16-bit devices: PIC24F and PIC24H/E, dsPIC30F and dsPIC33F/E. It is highly optimized and takes advantage of many PIC24/dsPIC DSC-specific features to provide efficient software code generation. Compiler also provides extensions that allow for excellent support of the hardware, such as interrupts and peripherals. It is fully integrated with the MPLAB IDE for high level, source level debugging with the hardware debugging tools. This compiler comes complete with its own assembler, linker and librarian to write mixed mode C and assembly programs and link the resulting object files into a single executable file. The compiler is also available separately for PIC24 MCUs and dsPIC DSCs. A free evaluation version is available for download, and is fully functional for 60 days. After the evaluation period, certain optimization levels are disabled. The evaluation edition has no code size limit.

Key Features

- ANSI-compliant with standard, math, memory, data conversion and math libraries
- Generates relocatable object modules for enhanced code reuse
- Optimized to generate as much as 30% less code than other 16-bit MCU compilers
- Strong support for in-line assembly when total control is absolutely necessary
- Peripheral library for quick coding using Microchip device peripherals
- Allows code and data to be located at absolute addresses
- Supports advanced code size optimizations
- Support for DSP accumulator registers from the C language (dsPIC devices only)
- Support for DSP intrinsics (functions) from the C language. DSP intrinsics map directly to native dsPIC assembly language instruction (dsPIC devices only)
- Free unrestricted evaluation version of the C compiler available for download

Compiler	Part Number	Price
MPLAB C Compiler for PIC24 MCUs and dsPIC DSCs*	SW006012	\$895
MPLAB C Compiler for dsPIC DSCs*	SW006013	\$495
MPLAB C Compiler for PIC24 MCUs*	SW006014	\$495

*Free evaluation copy can be downloaded.

MPLAB® C Compiler for PIC32 MCUs* (SW006015)

Summary

The MPLAB® C Compiler for PIC32 MCUs is a full-featured ANSI-compliant C compiler for Microchip's 32-bit microcontrollers. A free evaluation version is available for download, and is fully functional for 60 days. After the evaluation period, certain optimization levels are disabled. The evaluation edition has no code size limit, and is fully compatible with Microchip's MPLAB IDE and other popular third party IDEs.

Key Features

- DSP library – C callable DSP functions written in assembly using the standard MIPS DSP library APIs. A future compiler release will contain a second set of APIs that are compatible with Microchip's 16-bit compilers.
- Quick migration – Complete run-time optimized peripheral libraries that are API compatible with Microchip compiler libraries for 16-bit products.

- Includes floating point math library
- Even smaller code size – Use 16-bit instruction mode for up to 40% code size reduction
- Small and fast – mix 16- and 32-bit instruction types in the same source file: 32-bit instructions for performance critical code and 16-bit instructions for size reduction
- ANSI-compliant with standard, math, memory and data conversion libraries
- Highly optimized math library functions in v1.03 and later
- Supports in-line assembly
- Single and multi-vector interrupt support
- Generates relocatable object modules for enhanced code reuse
- Allows code and data to be located at absolute addresses

*MPLAB Compiler for PIC32 MCU family in LITE mode and Standard Eval Version are available for free download.

dsPICworks™ Data Analysis and DSP Software (SW300021)

Summary

dsPICwork Data Analysis and DSP Software tool is an easy-to-use data analysis and signal processing package for designs using dsPIC® Digital Signal Controllers (DSCs). This software supports an extensive number of functions which include signal generation, arithmetic operations, digital signal processing, up to 3 dimensional display and data import/export capabilities with MPLAB IDE and MPLAB ASM30.

Key Features

- Wide variety of signal generators – sine, square, triangular, window functions, noise
- Extensive DSP functions – FFT, DCT, filtering, convolution, interpolation
- Extensive arithmetic functions – algebraic expressions, data-scaling, clipping, etc.
- One, two and three-dimensional displays
- Multiple data quantization and saturation options
- Multi-channel data support
- Automatic script file-based execution options available for any user-defined sequence of dsPICworks data analysis and DSP software functions

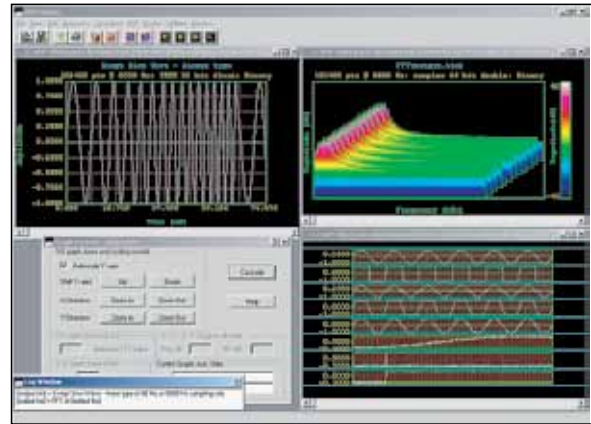

- File import/export interoperable with MPLAB IDE
- Digital filtering options support filters generated by dsPIC® DSC Digital Filter Design
- MPLAB ASM30 assembler file option to export data tables into dsPIC30F and dsPIC33F/E RAM

Digital Filter Design/Digital Filter Design Lite (SW300001/ SW300001-LT)

Summary

The Digital Filter Design tool for the 16-bit dsPIC30 and dsPIC33F/E Digital Signal Controllers (DSCs) makes designing, analyzing and implementing Finite Impulse Response (FIR) and Infinite Impulse Response (IIR) digital filters easy through a menu-driven and intuitive user interface. The filter design tool performs complex mathematical computations for filter design, provides superior graphical displays and generates comprehensive design reports. Desired filter frequency specifications are entered and the tool generates the filter code and coefficient files ready to use in the MPLAB® IDE Integrated Development Environment. System analysis of the filter transfer function is supported with multiple generated graphs.

Key Features

Finite Impulse Response Filter Design

- Design method selection
 - FIR window design
 - FIR equiripple design (Parks-McClellan)
- Low-pass, high-pass, band-pass and band-stop filters
- FIR filters can have up to 513 taps
- Various window functions are supported:
- Reports provide design details such as window coefficients and impulse response prior to multiplying by the window function

Infinite Impulse Response Filter Design

- Low-pass, high-pass, band-pass and band-stop filters
- Filter orders up to 10 for low-pass and high-pass filters
- Filter orders up to 20 for band-pass and band-stop filters
- Five analog prototype filters are available:
 - Butterworth
 - Tschebyscheff
 - Inverse Tschebyscheff
 - Elliptic
 - Bessel

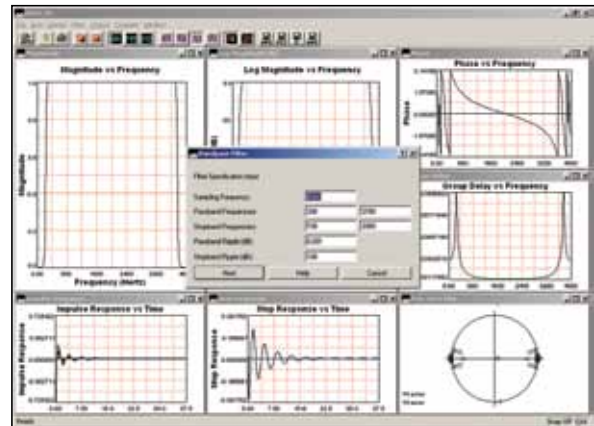

- Digital transformations are performed by bilinear transformation method
- Reports show design details such as all transformations from normalized low-pass filter to desired filter

Code Generation Features

- Generated files are compliant with Microchip's MPLAB C Compiler, assembler and linker
- Choice of placement of coefficients in program space or data space
- C wrapper/header code generation

Graphs

- Magnitude response vs. frequency
- Log magnitude vs. frequency
- Phase response vs. frequency
- Group delay vs. frequency
- Impulse response vs. time (per sample)
- Step response vs. time (per sample)
- Pole and zero locations (IIR only)

Real-Time Data Monitoring Tool

Summary

Applications such as motor control and power conversion require high-speed data monitoring from MPLAB® DMCI. Achieving such tasks with the existing debugging tools and the on-chip debugging module, requires the use of an additional communication link between a host PC and a target device. RTDM, along with MPLAB DMCI (MPLAB 8.10 or higher), creates an alternative link between a host PC and a target device for debugging applications in real time. Using these tools for getting data in and out of the target device allows developers to run their applications, while providing the ability to tune the variables and immediately see the effect without halting the application.

Key Features

- Runs under debug mode or user's application
- Fully compatible with MPLAB DMCI
- Provides dynamic access to control and monitor software variables without halting program execution
- No recompiling is required between debug sessions
- Ability to control or view any global variable defined by the target application code
- Provides an alternative link to read/write data from/to the target device
- Uses the RS-232 standard protocol as the primary communication link between the host PC and target device
- Maximum baud rate: 460800 bps
- Configurable to use the UART1 or UART2 modules on the target device
- Supported by all dsPIC30F, dsPIC33F/E and PIC24H/E devices

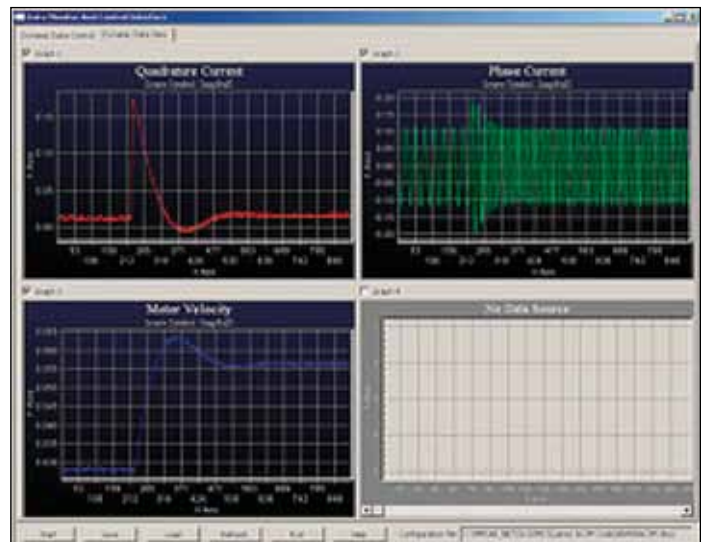
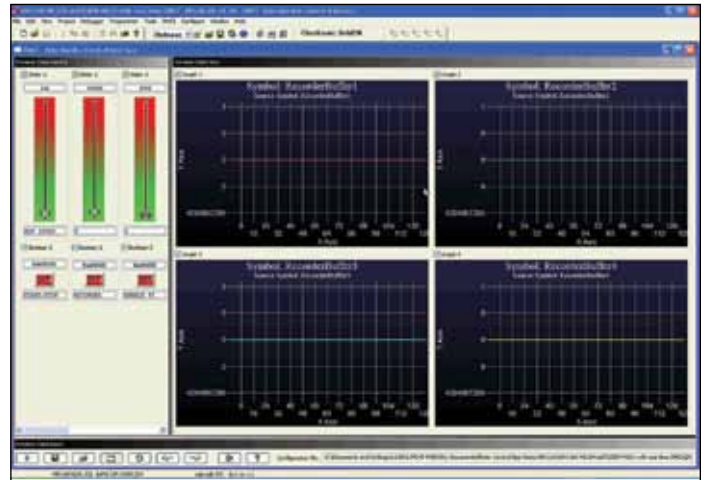

dsPIC® DSC Speech and Audio Fast Forward (SAFF) Tool

Summary

The SAFF is a PC-based application GUI simplifies speech and audio application development. The SAFF tool communicates with the target hardware via Microchip's Real-Time Data Monitoring (RTDM) protocol over an RS-232 or USB link. User can select several audio functions to implement and user has flexibility in choosing the speech/audio path (send or receive) to implement them in actual applications. The SAFF GUI tool is ready to use with Microchip's development boards and also on custom dsPIC30F/dsPIC33F/E hardware platform. The GUI has unique feature of generating code for selected controller platforms. This also can be used to tune algorithm parameters in addition to enable or disable algorithms for intended operation.

Key Features

- Supports dsPIC® DSC Acoustic Echo Cancellation, Line Echo Cancellation, Noise Suppression and Equalizer Libraries
- Implements typical full duplex communication signal processing chain with optimal arrangement of algorithms
- All algorithm parameters can be controlled in real time via RTDM
- The generated code from GUI tool can be ported to custom dsPIC DSC hardware

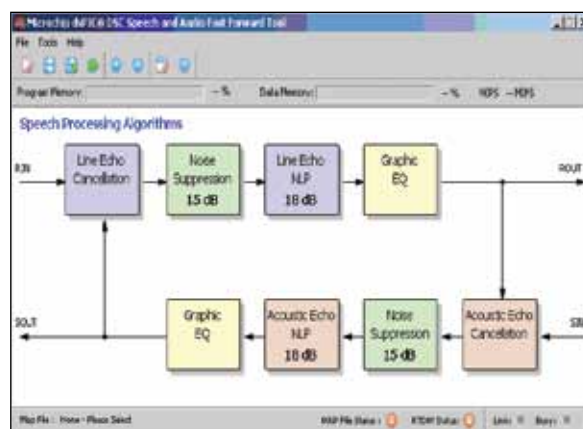

- Quick Start Demonstration included with installation
- Supports multiple serial communication rates for communicating with target dsPIC DSC
- Uses UART and Timer peripheral on the dsPIC DSC device to implement RTDM and MIPS measurement
- Parameters on target device can be update individually or in groups
- Simplifies the algorithm parameter tuning process generates code for selected hardware

FREE Microchip Graphics Display Designer

Summary

The Microchip Graphics Display Designer (GDD) is a visual design tool that provides customers with a quick and easy way of creating graphical user interface (GUI) screens for graphical interface applications on Microchip MCUs.

The GDD is a design tool created for use with the Microchip Graphics Library. It is also an MPLAB® IDE plug-in.

Key Features

- Simplifies coding for the GUI screens with an ability to draw, resize, and delete screen objects
- Eliminates the need to manually calculate the X/Y coordinates for on-screen object placements
- Generates output source files
- Ability to import various graphical resources, including custom fonts and bitmap images



FREE nanoWatt XLP Battery Life Estimator

Summary

The XLP Battery Life Estimator is a free software utility to aid in developing eXtreme Low Power applications with Microchip's PIC® MCUs featuring XLP technology. The tool estimates average current consumption and battery life. The utility allows users to select the target device, battery type, the application's operating conditions (such as voltage and temperature) and finally model the active and power-down times for their applications. The tool comes pre-loaded with the specifications of Microchip's PIC MCUs featuring nanoWatt XLP technology and commonly used batteries in embedded applications. Users can also create additional profiles for a custom battery of their choice, if necessary.

Key Features

- Profile your application Run and Sleep time (duty cycle)
- Select operating temperature and operating voltage
- Pre-loaded with electrical specifications of all PIC MCUs featuring XLP technology
- Pre-loaded with most common battery specifications
- Customizable to allow you to add other battery and peripheral device profiles and specifications

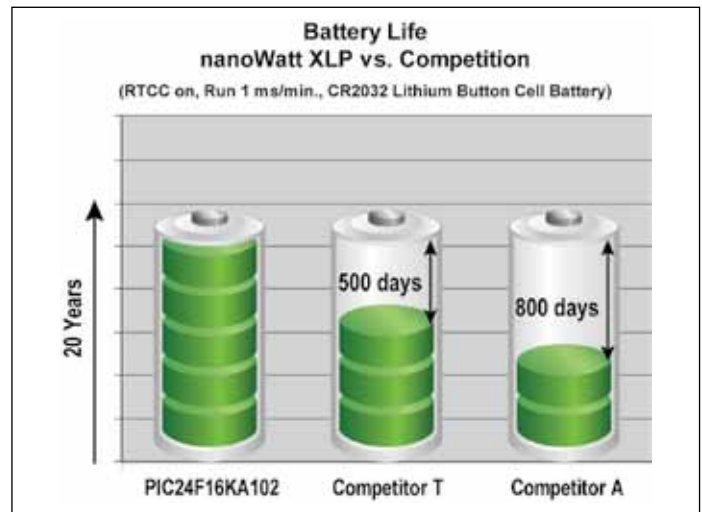

FREE Google PowerMeter Reference Implementation

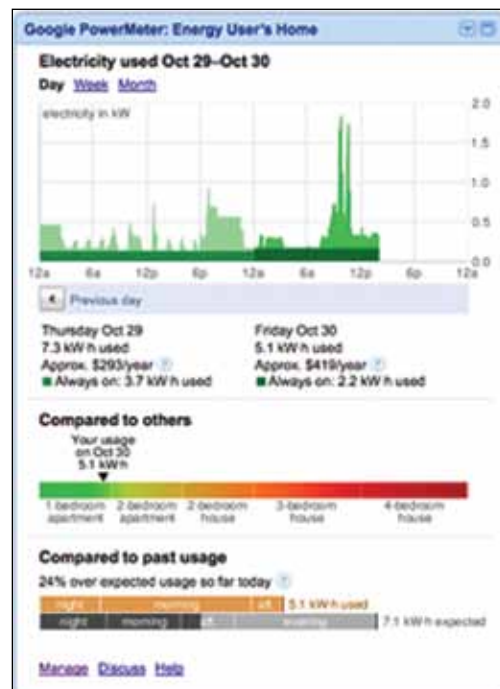

Summary

The Google PowerMeter service provides the ability to view power usage data through a web-based interface. This data can be uploaded to Google by embedded devices in breaker boxes, power strips or even in electronics themselves. Tracking power consumption makes users aware of the direct effect that various devices have on their power bills, which allows them to avoid using devices during peak power consumption hours and adjust their power usage to lower their bills. This makes the ability to monitor power consumption an attractive feature in a new device.



Third Party Software Tools, RTOS and Libraries

Third Party 16-bit Software Tools







Vendor	IDE	Compilers	Supports
	IAR Embedded Workbench	C/EC++	PIC24 MCU dsPIC DSC
	C Windows IDE	C	PIC24 MCU dsPIC® DSC
	Multi IDE	MPLAB® C	MPLAB® C IDE

Third Party 16-bit Libraries and RTOS Support



	Library/Tool Name	dsPIC33F	PIC24H	PIC24F
RTOS	CMX-Tiny+™	✓	✓	✓
	CMX-RTX™	✓	✓	✓
	CMX-Scheduler™	✓	✓	✓
	Micrium - µCOS II	✓	-	✓
	freeRTOS™	✓	✓	✓
	Segger - embOS	✓	✓	✓
	Express Logic - ThreadX®	✓	✓	✓
	AVIX-RT	✓	✓	✓
Connectivity	TCP/IP (CMX)	✓	✓	✓
	CANbedded (Vector-Informatik)	✓	✓	-
	OsCAN (Vector-Informatik)	✓	✓	-
Graphics	Segger - emWIN	✓	✓	✓
	RamTeX - GUI Lib	✓	✓	✓

Third Party Software Tools, RTOS and Libraries

PIC32 Third Party Software Options

Vendor	RTOS	GUI	TCP/IP	USB	Example Projects	Application Note	MPLAB IDE RTOS Viewer
	✓	-	-	-	✓	✓	✓
	✓	-	✓	-	-	-	✓
expresslogic	✓	-	-	✓	-	✓	✓
Micrium Empowering Embedded Systems	✓	-	-	-	✓	✓	✓
	✓	✓	✓	-	✓	✓	✓
	✓	-	-	-	-	-	-
	✓	-	✓	✓	✓	✓	-
	✓	✓	-	-	✓	-	✓
easyGUI	-	✓	-	-	-	-	-
	-	✓	-	-	-	-	-

PIC32 C++ and Eclipse Options from Third Parties

Vendor	IDE	Compilers	Debug Hardware
	Customized Eclipse	GNU C/C++ Microchip C	Ashling JTAG
	Multi IDE	Green Hills C/C++	Green Hills JTAG
LAUTERBACH 	Trace32 IDE	GNU C/C++ Microchip C	Lauterbach JTAG
Macraigor Systems Complete JTAG Debug Support	Standard Eclipse	GNU C/C++ Microchip C	Macraigor JTAG (3 models)

Support

Microchip is committed to supporting its customers in developing products faster and more efficiently. We maintain a worldwide network of field applications engineers and technical support ready to provide product and system assistance. In addition, the following service areas are available at www.microchip.com:

- **Support** link provides a way to get questions answered fast: <http://support.microchip.com>
- **Sample** link offers evaluation samples of any Microchip device: <http://sample.microchip.com>
- **Forum** link provides access to knowledge base and peer help: <http://forum.microchip.com>
- **Buy** link provides locations of Microchip Sales Channel Partners: www.microchip.com/sales

Sales Office Listing

AMERICAS

Atlanta
Tel: 678-957-9614

Boston
Tel: 774-760-0087

Chicago
Tel: 630-285-0071

Cleveland
Tel: 216-447-0464

Dallas
Tel: 972-818-7423

Detroit
Tel: 248-538-2250

Indianapolis
Tel: 317-773-8323

Los Angeles
Tel: 949-462-9523

Santa Clara
Tel: 408-961-6444

Toronto
Mississauga, Ontario
Tel: 905-673-0699

EUROPE

Austria - Wels
Tel: 43-7242-2244-39

Denmark - Copenhagen
Tel: 45-4450-2828

France - Paris
Tel: 33-1-69-53-63-20

Germany - Munich
Tel: 49-89-627-144-0

Italy - Milan
Tel: 39-0331-742611

Netherlands - Druen
Tel: 31-416-690399

Spain - Madrid
Tel: 34-91-708-08-90

UK - Wokingham
Tel: 44-118-921-5869

Training

If additional training interests you, then Microchip can help. We continue to expand our technical training options, offering a growing list of courses and in-depth curriculum locally, as well as significant online resources – whenever you want to use them.

- Technical Training Centers: www.microchip.com/training
- MASTERS Conferences: www.microchip.com/masters
- Worldwide Seminars: www.microchip.com/seminars
- eLearning: www.microchip.com/webseminars
- Resources from our Distribution and Third Party Partners www.microchip.com/training

ASIA/PACIFIC

Australia - Sydney
Tel: 61-2-9868-6733

China - Beijing
Tel: 86-10-8569-7000

China - Chengdu
Tel: 86-28-8665-5511

China - Chongqing
Tel: 86-23-8980-9588

China - Hangzhou
Tel: 86-571-2819-3180

China - Hong Kong SAR
Tel: 852-2401-1200

China - Nanjing
Tel: 86-25-8473-2460

China - Qingdao
Tel: 86-532-8502-7355

China - Shanghai
Tel: 86-21-5407-5533

China - Shenyang
Tel: 86-24-2334-2829

China - Shenzhen
Tel: 86-755-8203-2660

China - Wuhan
Tel: 86-27-5980-5300

China - Xiamen
Tel: 86-592-2388138

China - Xian
Tel: 86-29-8833-7252

China - Zhuhai
Tel: 86-756-3210040

ASIA/PACIFIC

India - Bangalore
Tel: 91-80-3090-4444

India - New Delhi
Tel: 91-11-4160-8631

India - Pune
Tel: 91-20-2566-1512

Japan - Yokohama
Tel: 81-45-471-6166

Korea - Daegu
Tel: 82-53-744-4301

Korea - Seoul
Tel: 82-2-554-7200

Malaysia - Kuala Lumpur
Tel: 60-3-6201-9857

Malaysia - Penang
Tel: 60-4-227-8870

Philippines - Manila
Tel: 63-2-634-9065

Singapore
Tel: 65-6334-8870

Taiwan - Hsin Chu
Tel: 886-3-6578-300

Taiwan - Kaohsiung
Tel: 886-7-213-7830

Taiwan - Taipei
Tel: 886-2-2500-6610

Thailand - Bangkok
Tel: 66-2-694-1351

5/2/11

Microcontrollers • Digital Signal Controllers • Analog • Memory • Wireless

The Microchip name and logo, the Microchip logo, PIC³² logo, dsPIC, MPLAB and PIC are registered trademarks of Microchip Technology Incorporated in the U.S.A. and other countries. FilterLab is a registered trademark of Microchip Technology Incorporated in the U.S.A. dsPICDEM, dsPICworks, ECAN, MiWi, mTouch, PICtail, PROMATE and REAL ICE are trademarks of Microchip Technology Incorporated in the U.S.A. and other countries. All other trademarks mentioned herein are property of their respective companies. © 2011, Microchip Technology Incorporated, All Rights Reserved. Printed in the U.S.A. 5/11 DS39962B



MICROCHIP
www.microchip.com

Microchip Technology Inc.
2355 W. Chandler Blvd.
Chandler, AZ 85224-6199