

Multifunction voltage regulator for car radio

Features

- L5958 six outputs:
 - 8.5 V @ 200 mA
 - 5.0 V @ 300 mA
 - 3.3 V @ 250 mA
 - 1.8 V @ 350 mA
 - 3.3 V @ 100 mA standby
 - 1.8 V @ 100 mA standby
- 2 A high side driver
- Reset function
- VDD core reset function
- Battery audio warning
- Battery can warning
- Ignition comparator
- Load dump protection
- Thermal shutdown
- Overcurrent limitation
- All pin ESD protected

Description

The L5958 includes 6 linear voltage regulators and a 2 A power switch, working down to 4.5 V battery level. All the voltage regulators can be switched off through the three enable pins.

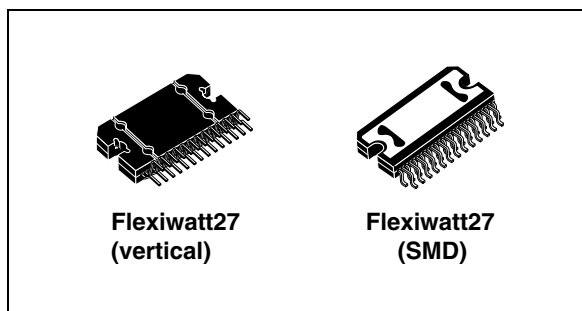

The two 3.3 V (REG5) and 1.8 V (REG6) stand-by regulators can reach a quasi-zero current consumption when switched off.

The device is equipped with two different reset buffers to control the operating voltages: the reset which checks the two stand-by outputs, 3.3V and 1.8 V, and the VDD core reset which checks the linear switched outputs, 3.3 V and 1.8 V. It is also equipped with two different battery voltage warnings, provided by the Hold CAN and the Hold audio detectors, with the possibility to program the lower threshold through an external resistance.

The ignition buffer completes the device.

A backup function is available through two pins which needs to be connected to two independent capacitors: one for the 3.3 V and 1.8 V linear switched outputs and one for the 3.3 V and 1.8 V standby outputs.

Table 1. Device summary

Order code	Package	Packing
L5958	Flexiwatt27 (vertical)	Tube
L5958SM	Flexiwatt27 (SMD)	Tube
L5958SMTR	Flexiwatt27 (SMD)	Tape and reel

Contents

1	Block diagram	5
2	Pin description	6
3	Electrical specifications	8
3.1	Absolute maximum ratings	8
3.2	Thermal data	8
3.3	Electrical characteristics	8
3.4	Application diagram	12
3.5	Timing diagrams	14
4	Package information	17
5	Revision history	19

List of tables

Table 1.	Device summary	1
Table 2.	Pin description	7
Table 3.	Absolute maximum ratings	8
Table 4.	Thermal data	8
Table 5.	Electrical characteristics	8
Table 6.	Document revision history	19

List of figures

Figure 1.	Block diagram	5
Figure 2.	Flexiwatt27 (SMD and vertical) pin connection (top view)	6
Figure 3.	Application circuit	12
Figure 4.	Regulator and power switch diagram	13
Figure 5.	Timing chart V_{batt} detection	14
Figure 6.	Timing chart 1.8 Vperm/3.3 Vperm and 1.8V sw/3.3 Vsw	14
Figure 7.	Reset and BU1 backup diagram	15
Figure 8.	BU2 backup diagram	15
Figure 9.	Maximum ESR for stability (valid for all the regulator outputs)	15
Figure 10.	Current limit of the power switch	16
Figure 11.	Flexiwatt27 (vertical) mechanical data and package dimensions	17
Figure 12.	Flexiwatt27 (SMD) mechanical data and package dimensions	18

1 Block diagram

Figure 1. Block diagram

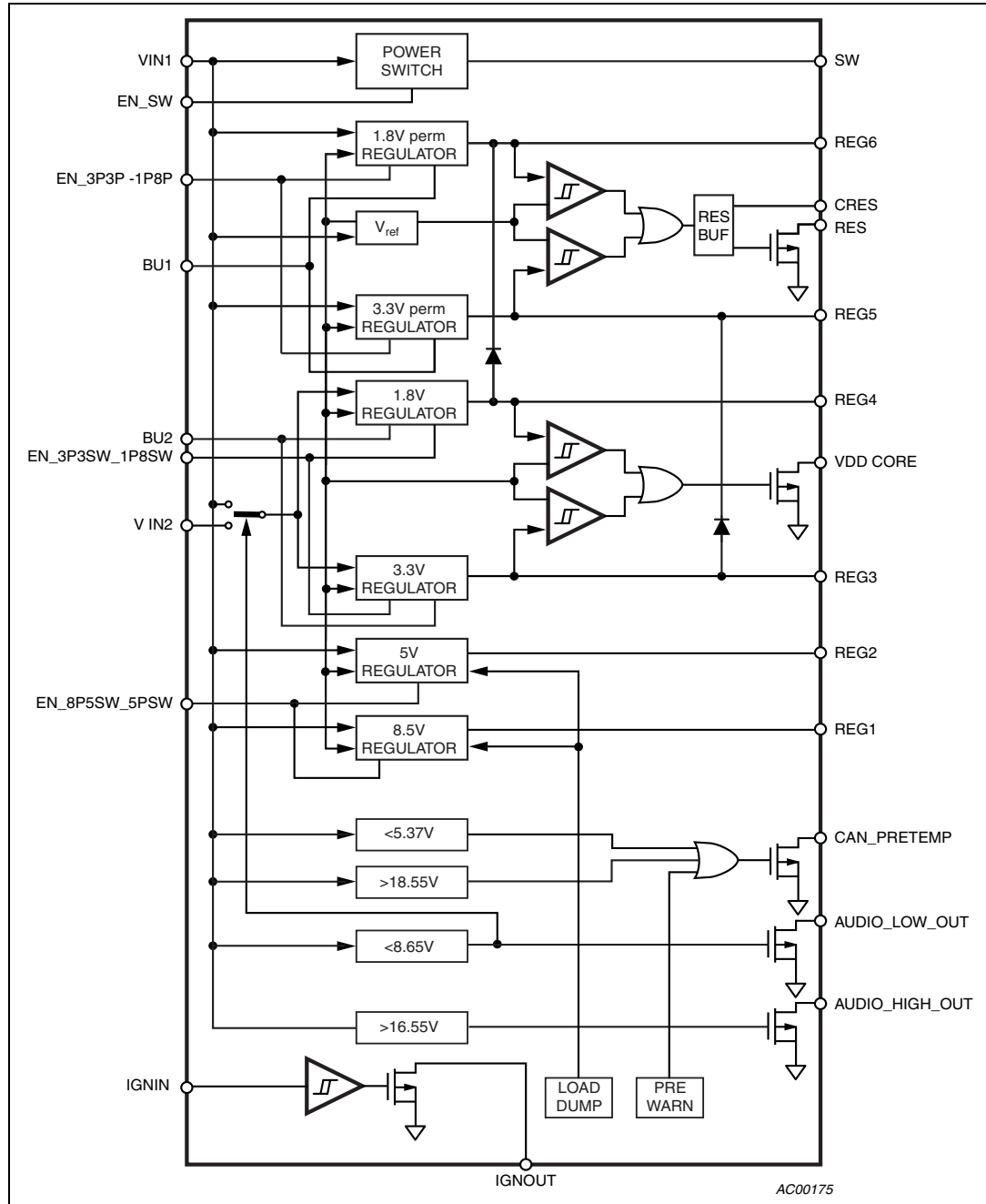

2 Pin description

Figure 2. Flexiwatt27 (SMD and vertical) pin connection (top view)

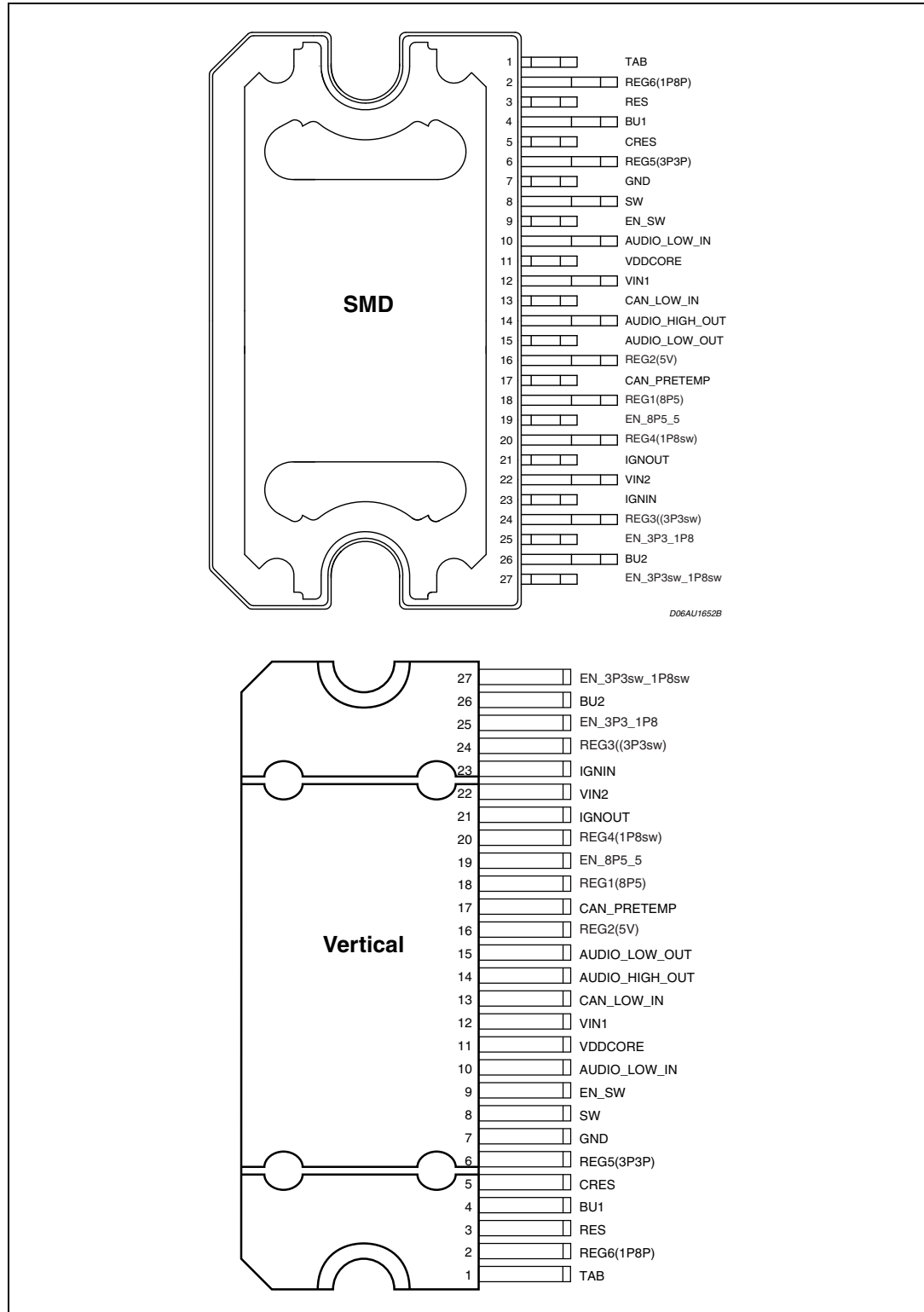

Table 2. Pin description

Pin N#	Pin name	Function	Type
1	TAB		
2	REG6(1P8P)	Output of Reg6 (1.8 V/100 mA)	O
3	RES	Reset signal for MCU application	O
4	BU1	Connect to a reserve capacitor. When battery is removed suddenly, the energy stored in this capacitor can still supply reg5 and reg6 for some time.	I/O
5	CRES	Connect a capacitor to delay reset signal	O
6	REG5(3P3P)	Output of Reg5 (3.3 V/100 mA)	O
7	GND	Power supply ground	S
8	SW	Output of power switch	O
9	EN_SW	Enable signal for SW	I
10	AUDIO_LOW_IN	Hold Audio Low threshold adjustment	I
11	VDDCORE	Warn signal to 3.3 Vsw or 1. 8Vsw	O
12	VIN1	Power supply for Reg1,Reg2,Reg5,Reg6 and SW	S
13	CAN_LOW_IN	Hold CAN Low threshold adjustment	I
14	AUDIO_HIGH_OUT	Hold Audio High signal for MCU application	O
15	AUDIO_LOW_OUT	Hold Audio Low signal for MCU application	O
16	REG2(5V)	Output of Reg2	O
17	CAN_PRETEMP	Hold can low signal or hold can high signal with load dump detection or pretemp warning	O
18	REG1(8P5)	Output of Reg1	O
19	EN_8P5_5	Enable signal for 5 V and 8.5 V	I
20	REG4(1P8sw)	Output of Reg4 (1.8 V/350 mA)	O
21	IGNOUT	Ignition signal output	O
22	VIN2	Power supply for Reg3 and Reg4	S
23	IGNIN	Ignition signal input	I
24	REG3((3P3sw)	Output of Reg3 (3.3 V / 250 mA)	O
25	EN_3P3_1P8	Enable signal for 3.3 Vperm and 1.8 Vperm. A resistor of 1 kΩ in series to this control pin is suggested.	I
26	BU2	Connect to a reserve capacitor. When battery is removed suddenly, the energy stored in this capacitor can still supply reg3 and reg4 for some time.	I/O
27	EN_3P3sw_1P8sw	Enable signal for 3.3 V and 1.8 V	I

3 Electrical specifications

3.1 Absolute maximum ratings

Table 3. Absolute maximum ratings

Symbol	Parameter	Value	Unit
V _{SDC}	DC operating supply voltage	30	V
V _{STR}	Transient supply voltage	50	V
I _O	Output current	internally limited	
T _{op}	Operating temperature range	-40 to 105	°C
T _{stg}	Storage temperature	-55 to 150	°C
T _j	Junction temperature	-55 to 150	°C
V _{pinMIN}	Minimum pin voltage (EN_SW, AUDIO_LOW_IN, CAN_LOW_IN, EN_8P5_5, IGNIN, EN_3P3_1P8, EN_3P3sw_1P8sw)	-0.3	V

3.2 Thermal data

Table 4. Thermal data

Symbol	Parameter	Value	Unit
R _{th j-case}	Thermal resistance junction-to-case	Max. 1.0	°C/W

3.3 Electrical characteristics

V_S = 14.4 V; T_{amb} = 25 °C; unless otherwise specified

Table 5. Electrical characteristics

Symbol	Parameter	Test condition	Min.	Typ.	Max.	Unit
Input supplies						
V _{in1}	Input supply voltage 1	Operating	9	-	18	V
V _{in2}	Input supply voltage 2	Operating	4.5	-	18	V
V _{in1}	Input supply voltage 1	Reverse polarity	-	not operating	-	-
V _{in2}	Input supply voltage 2	Reverse polarity	-	not operating	-	-
I _q	Total quiescent current	Standby (-40 °C to 85 °C) Perm reg on	-	50	100	µA
		Standby (25 °C) Perm reg off	-	4	10	µA
		Standby (-40 °C to 85 °C) Perm reg off	-	4	30	µA

Table 5. Electrical characteristics (continued)

Symbol	Parameter	Test condition	Min.	Typ.	Max.	Unit
Load dump V_{in1}	Battery over voltage	V_{in1}	24	26	28	V
Load dump V_{in2}	Battery over voltage	V_{in2}	24	26	28	V
Regulator 1						
$V_{O(8.5sw)}$	Output voltage 8.5V	-	8.0	8.5	8.9	V
ΔV	Line regulation	$I = 20\text{ mA}; 9\text{ V} < V_s < 18\text{ V}$	-	-	50	mV
ΔV_i	Load regulation	$I_{reg1} = 1\text{ to }20\text{ mA}$	-	-	100	mV
PSRR	Supply voltage ripple rejection	$f = 1\text{ kHz}; V_{in1} = 1.5\text{ Vpp}; I_o = 200\text{ mA}$	45	-	-	dB
V_{drop}	Drop out voltage	$I_{reg1} = 200\text{ mA}^{(1)}$	-	-	0.35	V
I_m	Current limit	$R_{short} = 0.5\ \Omega$	0.3	-	0.6	A
Regulator 2						
$V_{O(5Vsw)}$	Output voltage 5V	-	4.75	5	5.25	V
ΔV	Line regulation	$I = 300\text{ mA}; 9\text{ V} < V_s < 18\text{ V}$	-	-	50	mV
ΔV_i	Load regulation	$I_{reg2} = 1\text{ to }300\text{ mA}$	-	-	100	mV
PSRR	Supply voltage ripple rejection	$f = 1\text{ kHz}; V_{in1} = 1.5\text{ Vpp}; I_o = 300\text{ mA}$	50	-	-	dB
V_{drop}	Drop out voltage	$I_{reg2} = 300\text{ mA}^{(1)}$	-	-	0.45	V
I_m	Current limit	$R_{short} = 0.5\ \Omega$	400	-	800	mA
Regulator 3						
$V_{O(3.3sw)}$	Output voltage 3.3V	-	3.15	3.30	3.45	V
ΔV	Line regulation	$I = 250\text{ mA}; 4.5\text{ V} < V_s < 18\text{ V}$	-	-	50	mV
ΔV_i	Load regulation	$I_{reg3} = 1\text{ to }250\text{ mA}$	-	-	100	mV
PSRR	Supply voltage ripple rejection	$f = 1\text{ kHz}; V_{in1} = 1.5\text{ Vpp}; I_o = 250\text{ mA}$	50	-	-	dB
V_{drop}	Drop out voltage	$I_{reg3} = 250\text{ mA}^{(1)}$	-	-	0.75	V
I_m	Current limit	$R_{short} = 0.5\ \Omega$	400	-	800	mA
Regulator 4						
$V_{O(1.8sw)}$	Output voltage 1.8V	-	1.73	1.80	1.90	V
ΔV	Line regulation	$I = 350\text{ mA}; 4.5\text{ V} < V_s < 18\text{ V}$	-	-	50	mV
ΔV_i	Load regulation	$I_{reg4} = 1\text{ to }350\text{ mA}$	-	-	100	mV
PSRR	Supply voltage ripple rejection	$f = 1\text{ kHz}; V_{in1} = 1.5\text{ Vpp}; I_o = 350\text{ mA}$	50	-	-	dB
V_{drop}	Drop out voltage	$I_{reg4} = 350\text{ mA}^{(1)}$	-	-	2.2	V
I_m	Current limit	$R_{short} = 0.5\ \Omega$	430	-	800	mA

Table 5. Electrical characteristics (continued)

Symbol	Parameter	Test condition	Min.	Typ.	Max.	Unit
Regulator 5						
$V_{O(3.3perm)}$	Output voltage 3.3 V	-	3.15	3.30	3.45	V
ΔV	Line regulation	$I = 100 \text{ mA}; 9 \text{ V} < V_s < 18 \text{ V}$	-	-	50	mV
ΔV_i	Load regulation	$I_{reg4} = 1 \text{ to } 100 \text{ mA}$	-	-	100	mV
PSRR	Supply voltage ripple rejection	$f = 1 \text{ kHz}; V_{in1} = 1.5 \text{ Vpp}; I_o = 100 \text{ mA}$	50	-	-	dB
V_{drop}	Drop out voltage	$I_{reg4} = 100 \text{ mA}^{(1)}$	-	-	0.7	V
I_m	Current limit	$R_{short} = 0.5 \Omega$	150	-	300	mA
Regulator 6						
$V_{O(1.8perm)}$	Output voltage 1.8V	-	1.73	1.80	1.90	V
ΔV	Line regulation	$I = 100 \text{ mA}; 9 \text{ V} < V_s < 18 \text{ V}$	-	-	50	mV
ΔV_i	Load regulation	$I_{reg4} = 1 \text{ to } 100 \text{ mA}$	-	-	100	mV
PSRR	Supply voltage ripple rejection	$f = 1 \text{ kHz}; V_{in1} = 1.5 \text{ Vpp}; I_o = 100 \text{ mA}$	50	-	-	dB
V_{drop}	Drop out voltage	$I_{reg4} = 100 \text{ mA}^{(1)}$	-	-	2.2	V
I_m	Current limit	$R_{short} = 0.5 \Omega$	150	-	300	mA
Power switch						
V_{dropSW}	Drop voltage power switch	$I_{dcSW} = 1.8 \text{ A max.}$	-	-	0.5	V
I_{pSW1}	Peak current power switch	Peak time < 10 ms	2	-	3.5	A
I_{pSW2}	Peak current power switch	Peak time > 40 ms	0.9	-	2	A
SWDEL	Delay Protection	-	10	-	40	ms
Reset buffer (open drain RESET for permanent regulators)						
RES_{reg5}	RES threshold voltage for reg5	$V_{reg5} = 3.3 \text{ V}$	3.00	3.15	3.25	V
V_{hys_reg5}	hysteresis of reset for reg5		10	50	100	mV
RES_{reg6}	RES threshold voltage for reg6	$V_{reg6} = 1.8 \text{ V}$	1.67	-	1.833	V
V_{hys_reg6}	Hysteresis of reset for reg6		10	20	40	mV
V_{ol}	Low level	$I_{SINK(RES)} = 1 \text{ mA}$	-	0.3	0.5	V
$I_{Lsink(RES)}$	Low level sink current	Reset = 5 V	15	20	24	mA
RES delay	$C_{res} = 47\text{nF}$		20	42	70	ms
ΔT_{RES}	Reset rise and fall time	$R = 10 \text{ k}\Omega \text{ \& } C = 15 \text{ pF}$	-	-	50	μs
I_{Charge}	Charge current	$C_{RES} = 0 \text{ V}$	1	2	3	μA
$I_{Discharge}$	Discharge current	$C_{RES} = 5 \text{ V}$	0.5	-	3	mA

Table 5. Electrical characteristics (continued)

Symbol	Parameter	Test condition	Min.	Typ.	Max.	Unit
VDD_CORE_VAL buffer (open drain RESET for switched regulators)						
RES _{reg3}	RES threshold voltage for reg3	V _{reg3} = 3.3 V	3.00	3.15	3.25	V
V _{hys_reg3}	Hysteresis of reset for reg3	-	10	50	100	mV
RES _{reg4}	RES threshold voltage for reg4	V _{reg4} = 1.8 V	1.67	-	1.833	V
V _{hys_reg4}	Hysteresis of reset for reg4	-	10	20	40	mV
V _{ol}	Low level	I _{SINK(RES)} = 1 mA	-	0.3	0.5	V
Hold CAN signal (open drain for VIN1 battery warning 1)						
Hold1_high	Hold high threshold	-	17	-	20	V
V _{HYS}	Hysteresis high TH.	-	150	400	600	mV
Hold1_low	Hold low threshold	-	5	-	6	V
V _{HYS}	Hysteresis low TH.	-	200	400	600	mV
V _{ol}	Low level	I _{SINK(RES)} = 1 mA	-	0.3	0.5	V
V _{REF}	Reference voltage	-	-	1.2565	-	V
Hold audio signal (open drain for VIN1 battery warning 2)						
Hold2_high	Hold high threshold	-	15.2	-	17.8	V
V _{HYS}	Hysteresis high TH.	-	150	400	600	mV
Hold2_low	Hold low threshold	-	7.8	-	9.2	V
V _{HYS}	Hysteresis low TH.	-	200	400	600	mV
V _{ol}	Low level	I _{SINK(RES)} = 1 mA	-	0.3	0.5	V
V _{REF}	Reference voltage	-	-	1.2565	-	V
Ignition buffer (open drain)						
IGN _{IN}	I _{GNout} falling	-	1.03	1.17	1.28	V
V _{hys(IGNout)}	Hysteresis of ignition buffer	-	30	50	100	mV
V _{ol}	Low level	I _{Lsink(IGNout)} = 1 mA	-	0.3	0.5	V
IGN _{RISE}	Rising time	C = 15 pF	-	-	10	μs
IGN _{FALL}	Fall time	C = 15 pF	-	-	10	μs
I _{CLAMP}	Input clamp current	V _{CC} < V _{IGN} < 50 V	-	-	2	mA
IGN _{IN}	Input voltage	Operative	0	-	50	V
Enable input (regulators 1,2,3,4,5,6 and power switch)						
V _{TH}	Voltage threshold	-	1.3	-	2.3	V
EN _{IN(reg1,2,3,4 power switch)}	Input voltage	Operative	0	-	5	V
EN _{IN(reg5,6)}	Input voltage	Operative	0	-	24	V

1. Drop condition means that the supply voltage drop down to 100 mV from the regulated output and the regulator is sourcing its maximal load current

3.4 Application diagram

Figure 3. Application circuit

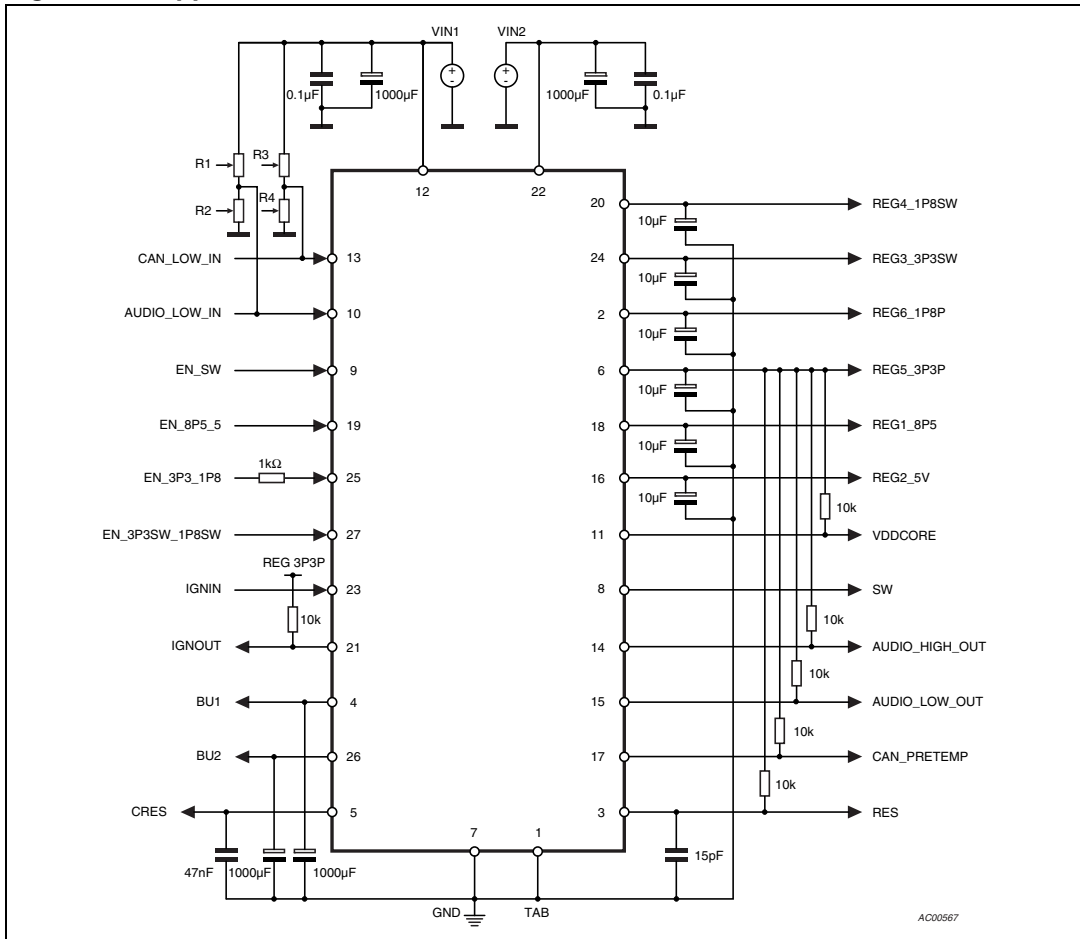

Recommended output filtering capacitors for all the regulators: C range = 5 µF to 100 µF, ESR range = 50 mΩ to 10 Ω (T= -40 °C to +85 °C)

The detection voltage thresholds (for both the battery warning 1 and 2) can be changed lower with external resistors, as following:

$$V_{TH1}(\text{hold_can}) = 1.25V (R3 + R4) / R4$$

$$V_{TH2}(\text{hold_audio}) = 1.25V (R1 + R2) / R2$$

Figure 4. Regulator and power switch diagram

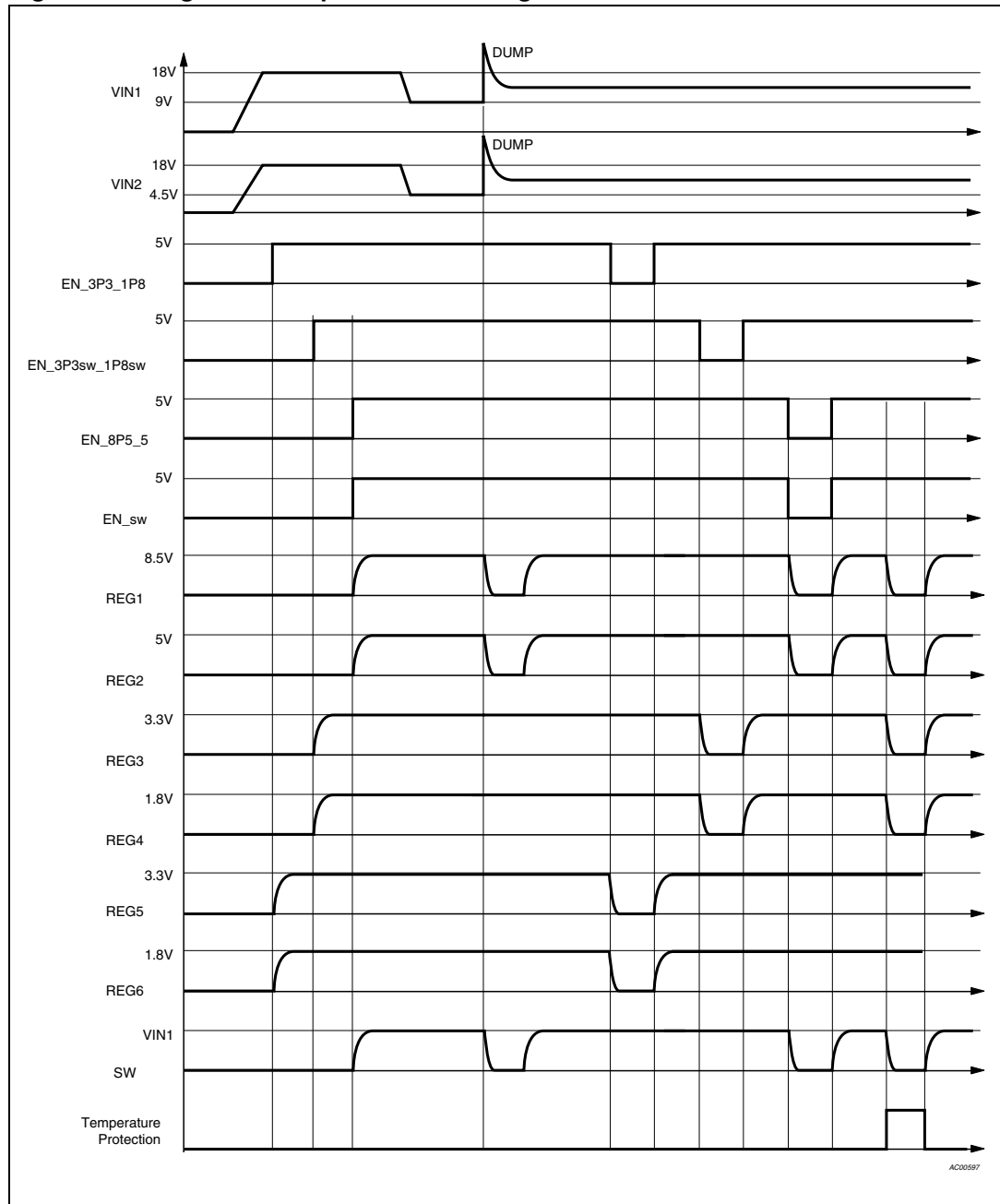

3.5 Timing diagrams

Figure 5. Timing chart V_{batt} detection

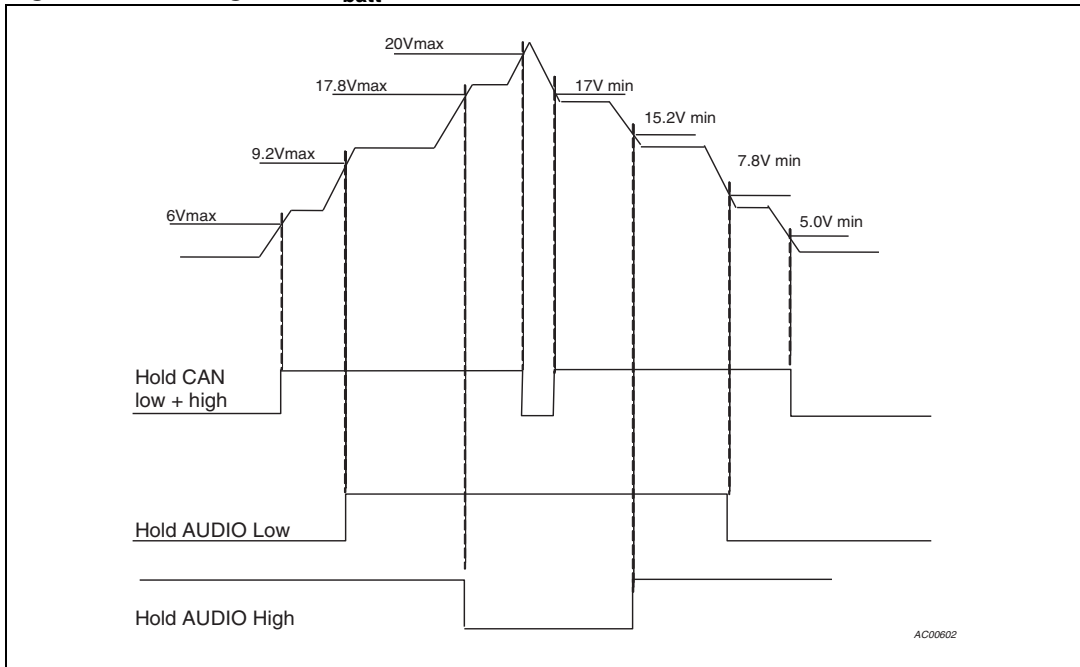

Figure 6. Timing chart 1.8 Vperm/3.3 Vperm and 1.8V sw/3.3 Vsw

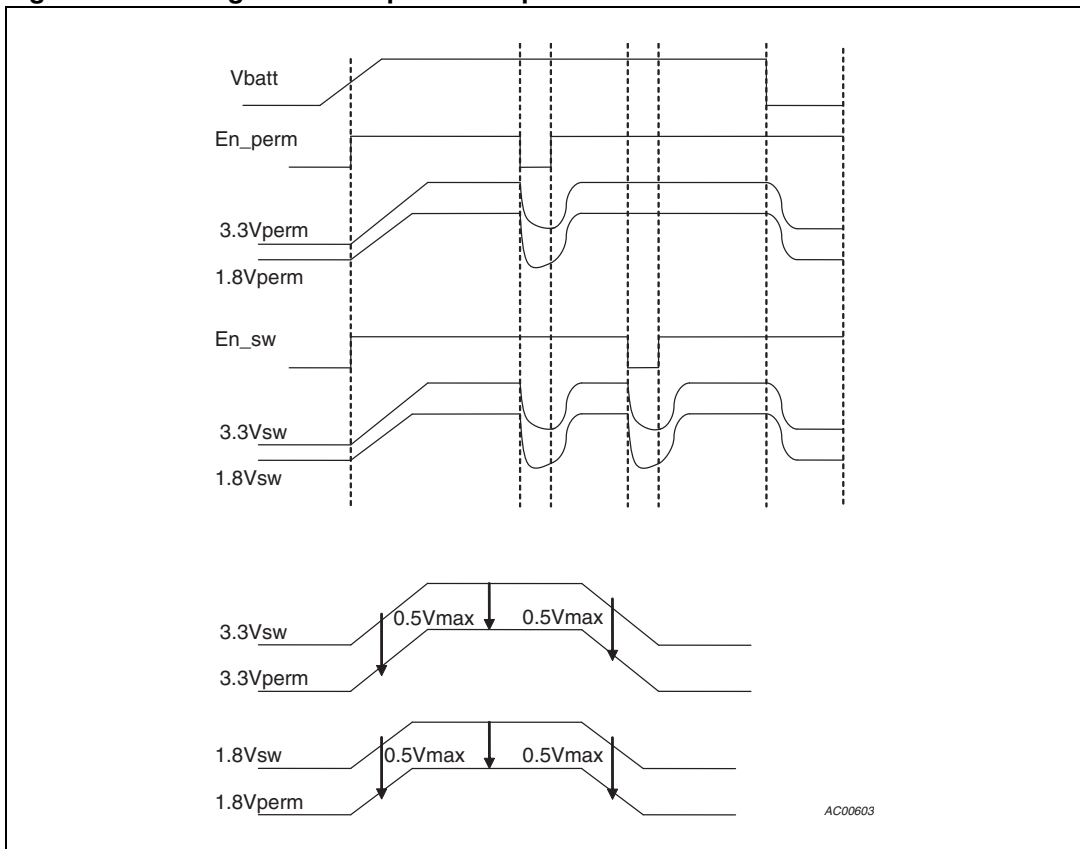

Figure 7. Reset and BU1 backup diagram

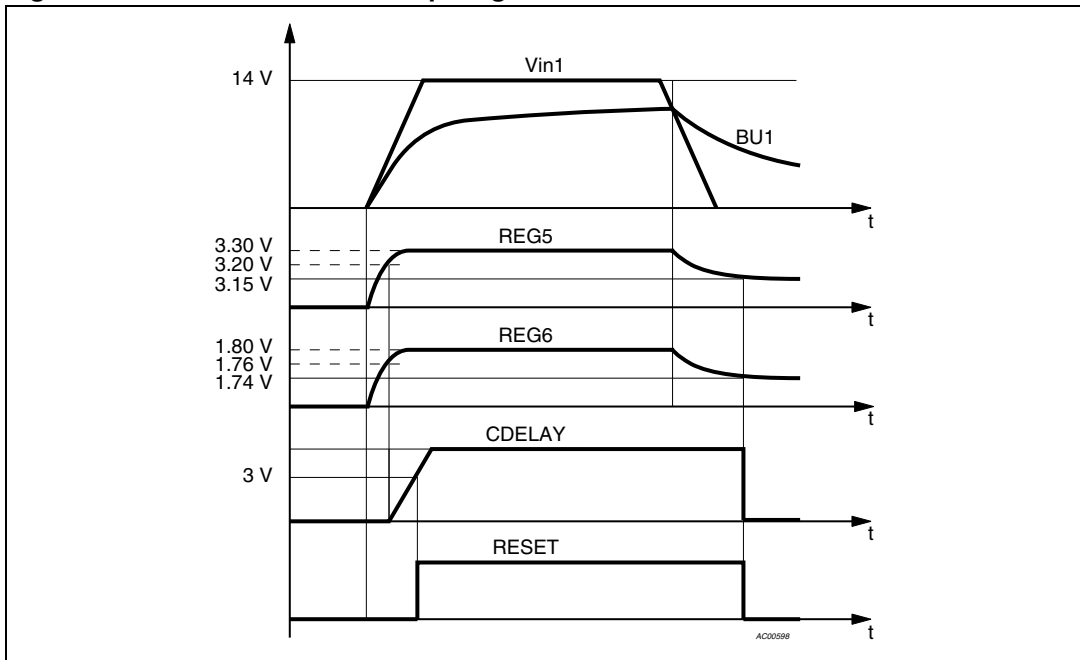

Figure 8. BU2 backup diagram

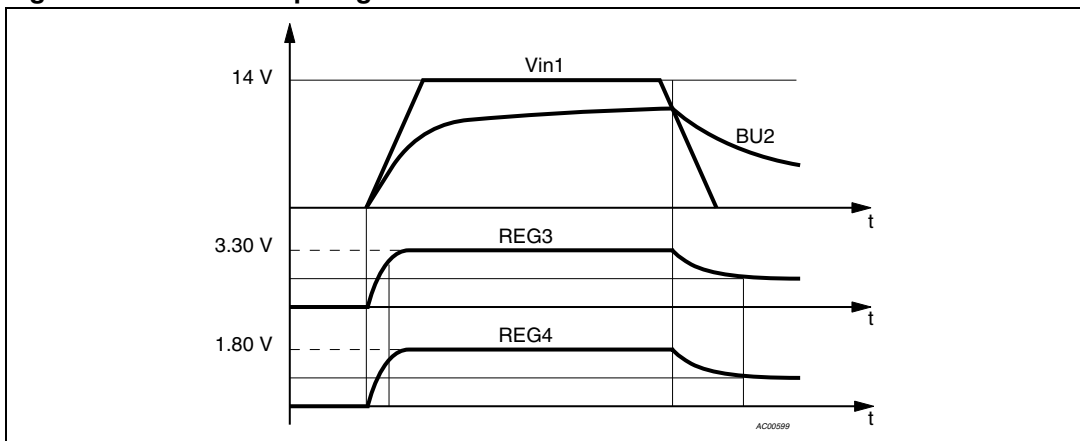

Figure 9. Maximum ESR for stability (valid for all the regulator outputs)

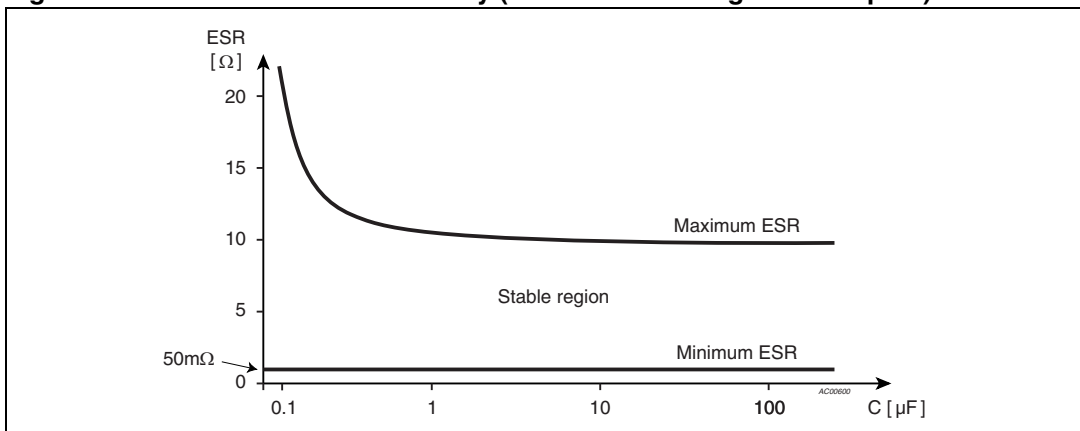
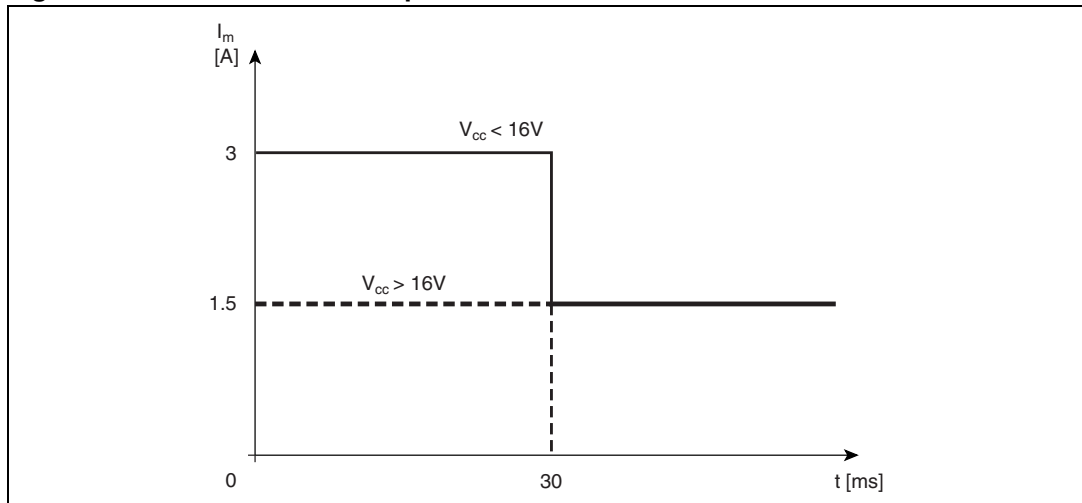

Figure 10. Current limit of the power switch



4 Package information

In order to meet environmental requirements, ST offers these devices in different grades of ECOPACK® packages, depending on their level of environmental compliance. ECOPACK® specifications, grade definitions and product status are available at: www.st.com.

ECOPACK® is an ST trademark.

Figure 11. Flexiwatt27 (vertical) mechanical data and package dimensions

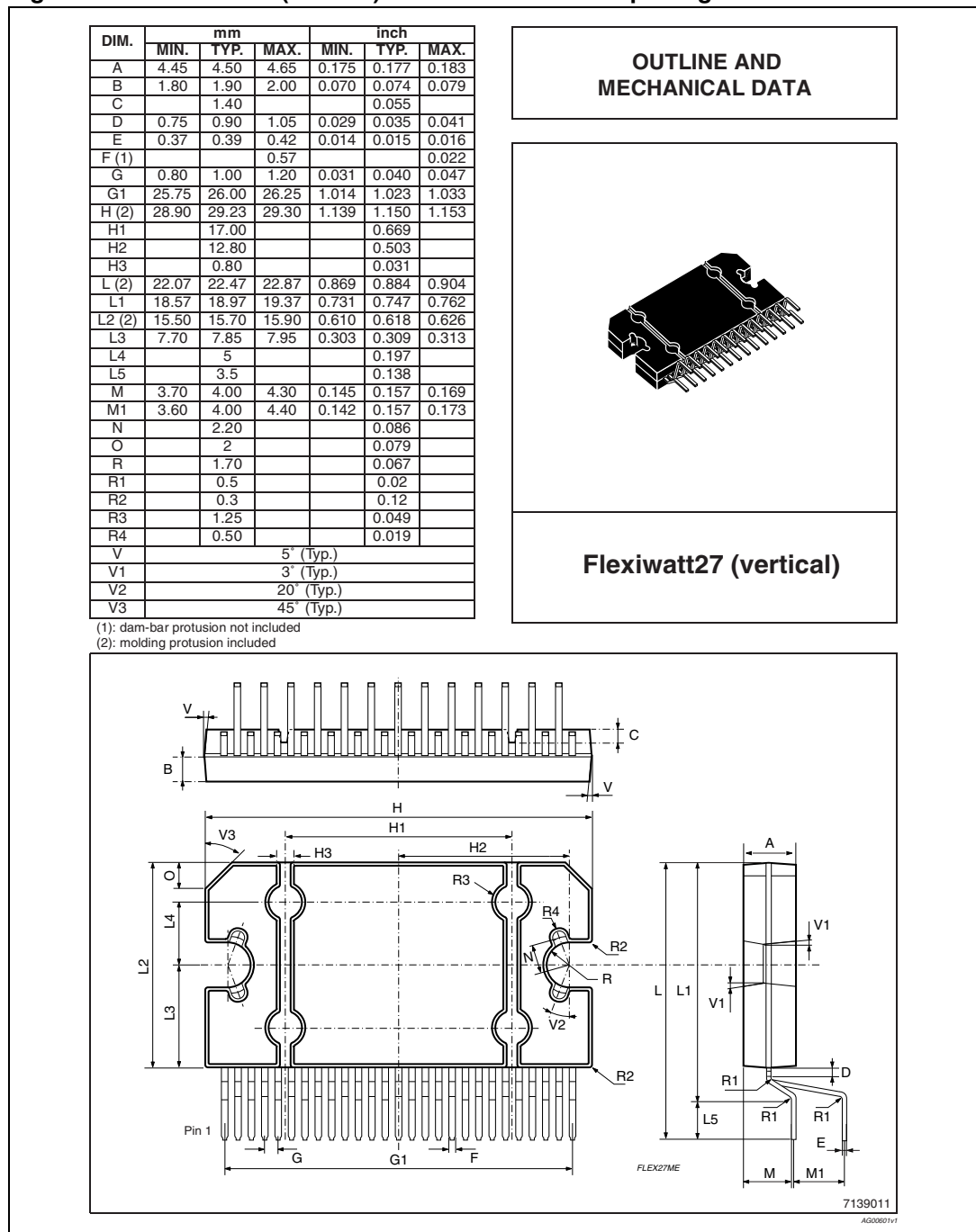
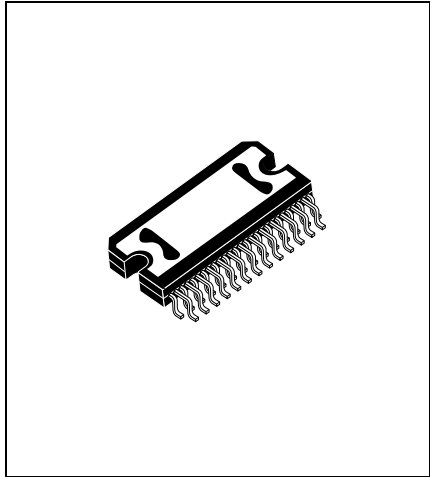

Figure 12. Flexiwatt27 (SMD) mechanical data and package dimensions

DIM.	mm			inch		
	MIN.	TYP.	MAX.	MIN.	TYP.	MAX.
A	4.45	4.50	4.65	0.1752	0.1772	0.1831
B	2.12	2.22	2.32	0.0835	0.0874	0.0913
C		1.40			0.0551	
D		2.00			0.0787	
E	0.36	0.40	0.44	0.0142	0.0157	0.0173
F**	0.47	0.51	0.57	0.0185	0.0201	0.0224
G(*)	0.75	1.00	1.25	0.0295	0.0394	0.0492
G1	25.70	26.00	26.30	1.0118	1.0236	1.0354
G2(*)	1.75	2.00	2.25	0.0689	0.0787	0.0886
H(**)	28.85	29.23	29.40	1.1358	1.1508	1.1575
H1		17.00			0.6693	
H2		12.80			0.5039	
H3		0.80			0.0315	
L(**)	15.50	15.70	15.90	0.6102	0.6181	0.6260
L1	7.70	7.85	7.95	0.3031	0.3091	0.3130
L2	14.00	14.20	14.40	0.5512	0.5591	0.5669
L3	11.80	12.00	12.20	0.4646	0.4724	0.4803
L4	1.30	1.48	1.66	0.0512	0.0583	0.0654
L5	2.42	2.50	2.58	0.0953	0.0984	0.1016
L6	0.42	0.50	0.58	0.0165	0.0197	0.0228
M		1.50			0.0591	
N		2.20			0.0866	
N1	1.30	1.48	1.66	0.0512	0.0583	0.0654
N2(*)	2.73	2.83	2.93	0.1075	0.1114	0.1154
P(*)	4.73	4.83	4.93	0.1862	0.1902	0.1941
R		1.70			0.0669	
R1		0.30			0.0118	
R2	0.35	0.40	0.45	0.0138	0.0157	0.0177
R3	0.35	0.40	0.45	0.0138	0.0157	0.0177
R4		0.50			0.0197	
T(*)	-0.08		0.10	-0.0031		0.0039
aaa(*)		0.1			0.0039	
V		45°			45°	
V1		3°			3°	
V2	3°	5°	7°	3°	5°	7°
V3	12°	15°	18°	12°	15°	18°
V4		5°			5°	
V5		20°			20°	

OUTLINE AND MECHANICAL DATA



Flexiwatt27 (SMD)

(*) Golden parameters
 (**) - Dimension "F" doesn't include dam-bar protrusion.
 - Dimensions "H" and "L" include mold flash or protrusions.

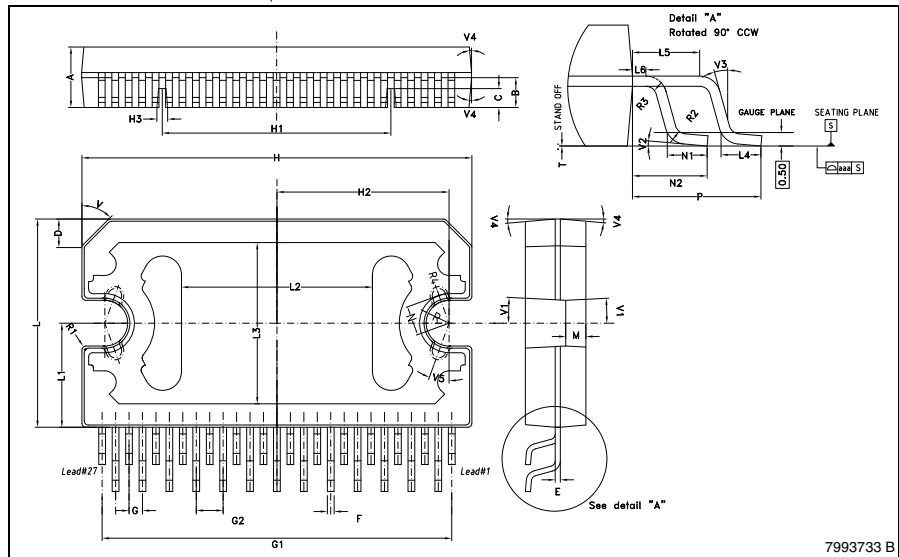

5 Revision history

Table 6. Document revision history

Date	Revision	Changes
12-Jul-2010	1	Initial release.
18-Sep-2013	2	Updated Disclaimer.

Please Read Carefully:

Information in this document is provided solely in connection with ST products. STMicroelectronics NV and its subsidiaries ("ST") reserve the right to make changes, corrections, modifications or improvements, to this document, and the products and services described herein at any time, without notice.

All ST products are sold pursuant to ST's terms and conditions of sale.

Purchasers are solely responsible for the choice, selection and use of the ST products and services described herein, and ST assumes no liability whatsoever relating to the choice, selection or use of the ST products and services described herein.

No license, express or implied, by estoppel or otherwise, to any intellectual property rights is granted under this document. If any part of this document refers to any third party products or services it shall not be deemed a license grant by ST for the use of such third party products or services, or any intellectual property contained therein or considered as a warranty covering the use in any manner whatsoever of such third party products or services or any intellectual property contained therein.

UNLESS OTHERWISE SET FORTH IN ST'S TERMS AND CONDITIONS OF SALE ST DISCLAIMS ANY EXPRESS OR IMPLIED WARRANTY WITH RESPECT TO THE USE AND/OR SALE OF ST PRODUCTS INCLUDING WITHOUT LIMITATION IMPLIED WARRANTIES OF MERCHANTABILITY, FITNESS FOR A PARTICULAR PURPOSE (AND THEIR EQUIVALENTS UNDER THE LAWS OF ANY JURISDICTION), OR INFRINGEMENT OF ANY PATENT, COPYRIGHT OR OTHER INTELLECTUAL PROPERTY RIGHT.

ST PRODUCTS ARE NOT DESIGNED OR AUTHORIZED FOR USE IN: (A) SAFETY CRITICAL APPLICATIONS SUCH AS LIFE SUPPORTING, ACTIVE IMPLANTED DEVICES OR SYSTEMS WITH PRODUCT FUNCTIONAL SAFETY REQUIREMENTS; (B) AERONAUTIC APPLICATIONS; (C) AUTOMOTIVE APPLICATIONS OR ENVIRONMENTS, AND/OR (D) AEROSPACE APPLICATIONS OR ENVIRONMENTS. WHERE ST PRODUCTS ARE NOT DESIGNED FOR SUCH USE, THE PURCHASER SHALL USE PRODUCTS AT PURCHASER'S SOLE RISK, EVEN IF ST HAS BEEN INFORMED IN WRITING OF SUCH USAGE, UNLESS A PRODUCT IS EXPRESSLY DESIGNATED BY ST AS BEING INTENDED FOR "AUTOMOTIVE, AUTOMOTIVE SAFETY OR MEDICAL" INDUSTRY DOMAINS ACCORDING TO ST PRODUCT DESIGN SPECIFICATIONS. PRODUCTS FORMALLY ESCC, QML OR JAN QUALIFIED ARE DEEMED SUITABLE FOR USE IN AEROSPACE BY THE CORRESPONDING GOVERNMENTAL AGENCY.

Resale of ST products with provisions different from the statements and/or technical features set forth in this document shall immediately void any warranty granted by ST for the ST product or service described herein and shall not create or extend in any manner whatsoever, any liability of ST.

ST and the ST logo are trademarks or registered trademarks of ST in various countries.

Information in this document supersedes and replaces all information previously supplied.

The ST logo is a registered trademark of STMicroelectronics. All other names are the property of their respective owners.

© 2013 STMicroelectronics - All rights reserved

STMicroelectronics group of companies

Australia - Belgium - Brazil - Canada - China - Czech Republic - Finland - France - Germany - Hong Kong - India - Israel - Italy - Japan - Malaysia - Malta - Morocco - Philippines - Singapore - Spain - Sweden - Switzerland - United Kingdom - United States of America

www.st.com

Mouser Electronics

Authorized Distributor

Click to View Pricing, Inventory, Delivery & Lifecycle Information:

[STMicroelectronics:](#)

[L5958SM](#) [L5958SMTR](#)