



SS1040HE SERIES

SURFACE MOUNT SCHOTTKY BARRIER RECTIFIER

VOLTAGE 40-200V **CURRENT** 1 Ampere

SOD-123HE Unit : inch(mm)

FEATURES

- Fast switching speed
- Surface mount package ideally suited for automatic insertion
- Electrical identical standard JEDEC.
- High conductor
- Lead free in compliance with EU RoHS 2.0
- Green molding compound as per IEC 61249 standard

MECHANICAL DATA

- Case: SOD-123HE, Plastic
- Terminals: Solderable per MIL-STD-750, Method 2026
- Apporx. Weight: 0.0006 ounces, 0.0184 grams
- Polarity: Color band denotes cathode end

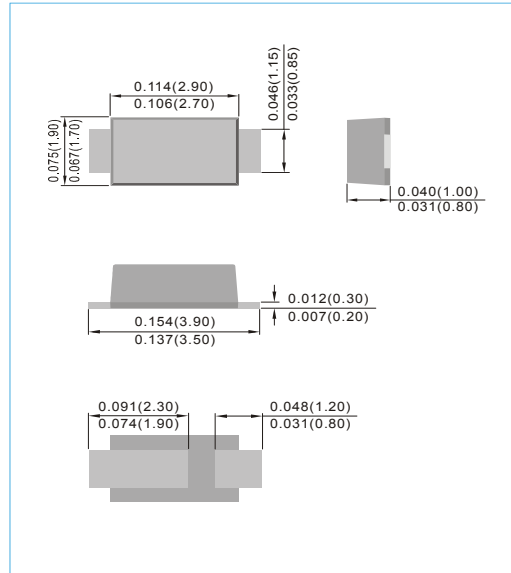
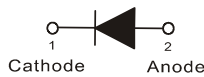
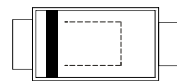

MAXIMUM RATINGS AND ELECTRICAL CHARACTERISTICS (T_A=25°C unless otherwise noted)

PARAMETER	SYMBOL	SS1040HE	SS1060HE	SS10100HE	SS10150HE	SS10200HE	UNITS
Marking Code		EM	EN	EP	ERL	ES	
Maximum Recurrent Peak Reverse Voltage	V _{RRM}	40	60	100	150	200	V
Maximum RMS Voltage	V _{RMS}	28	42	70	105	140	V
Maximum DC Blocking Voltage	V _R	40	60	100	150	200	V
Maximum Average Forward Current	I _O	1					A
Peak Forward Surge Current : 8.3ms single half sine-wave superimposed on rated load	I _{FSM}	30					A
Maximum Forward Voltage at 1A	V _F	0.55	0.7	0.8	0.85		V
Maximum DC Reverse Current	I _R	30					μA
Typical Junction capacitance at V _R =0V, f=1MHz	C _J	155	125	100	85		pF
Typical Thermal Resistance, Junction to Ambient (Note 2) Junction to Case (Note 1)	R _{θJA} R _{θJC}	185 20					°C/W
Operating Junction Temperature and Storage Temperature Range	T _J , T _{STG}	-55 to +150					°C

NOTES:

1. Mounted on a FR4 PCB, single-sided copper, with 100cm² copper pad area.
2. Mounted on a FR4 PCB, single-sided copper, mini pad.



SS1040HE SERIES

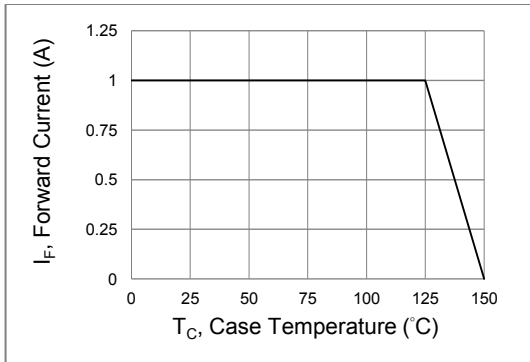

Fig.1 Forward Current Derating Curve

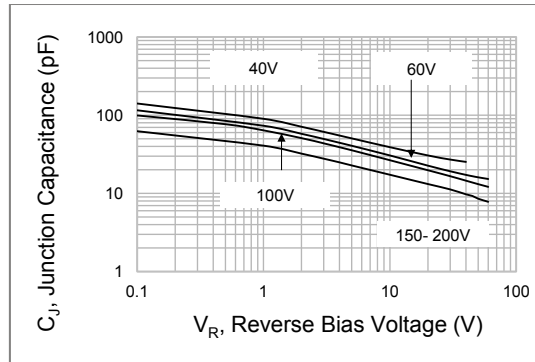

Fig.2 Typical Junction Capacitance

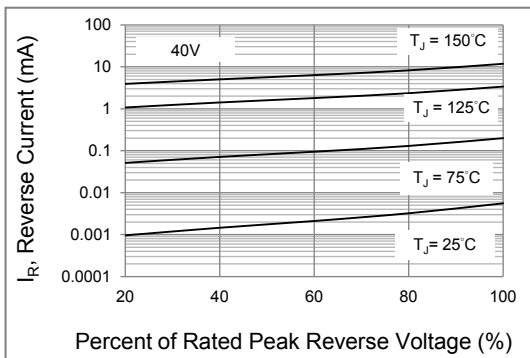

Fig.3 Typical Reverse Characteristics

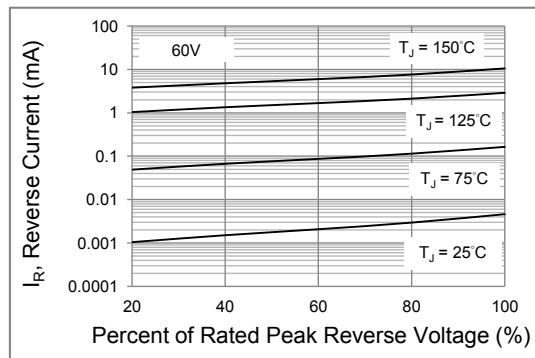

Fig.4 Typical Reverse Characteristics

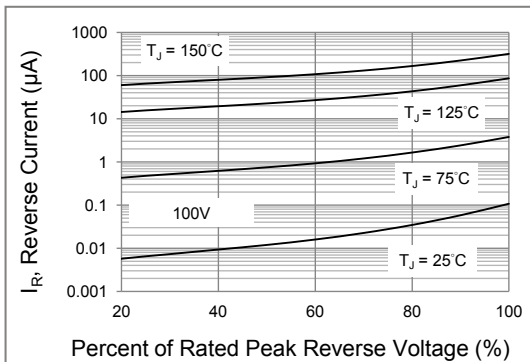

Fig.5 Typical Reverse Characteristics

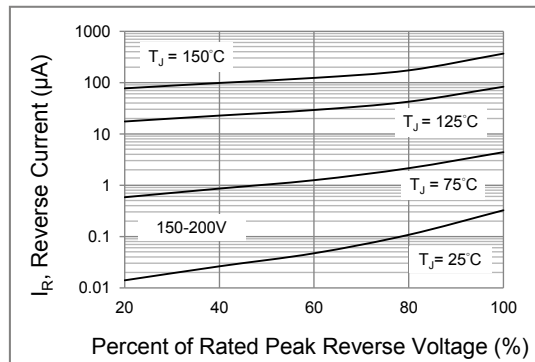

Fig.6 Typical Reverse Characteristics

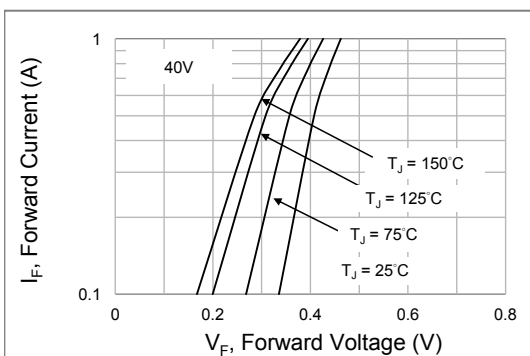

Fig.7 Typical Forward Characteristics

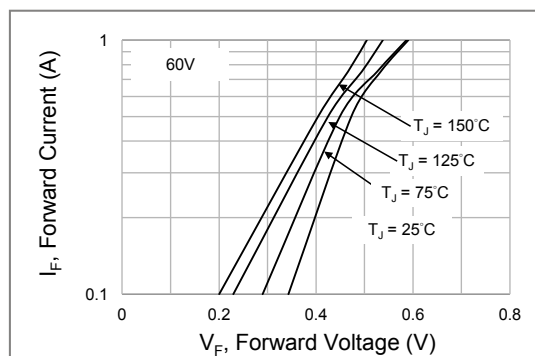

Fig.8 Typical Forward Characteristics



SS1040HE SERIES

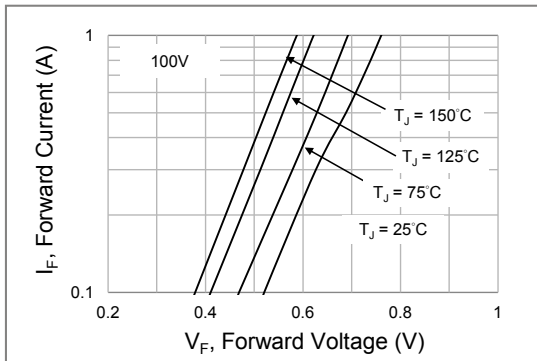

Fig.9 Typical Forward Characteristics

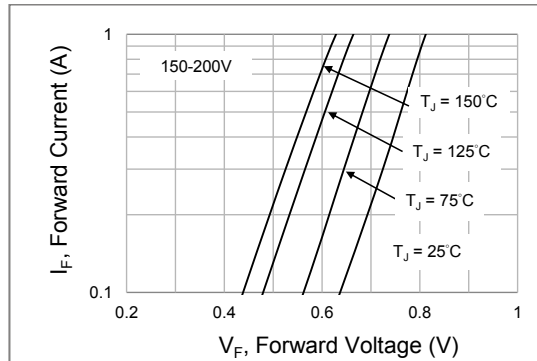

Fig.10 Typical Forward Characteristics

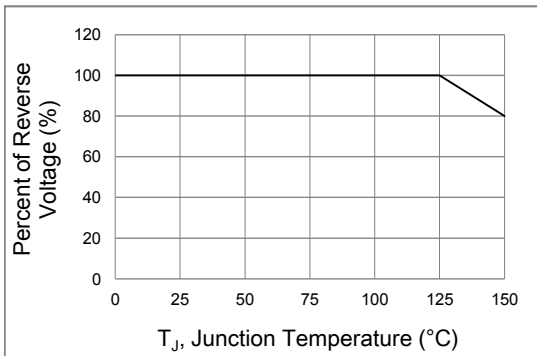

Fig.11 Operating Temperature Derating Curve



SS1040HE SERIES

MOUNTING PAD LAYOUT

SOD-123HE

Unit : inch(mm)

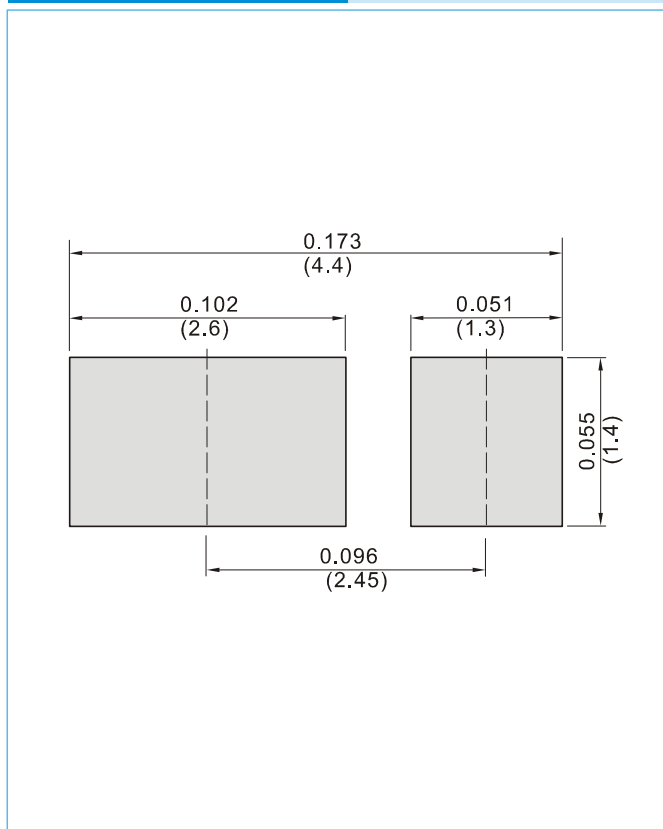

ORDER INFORMATION

- Packing information
T/R - 10K per 13" plastic Reel
T/R - 3K per 7" plastic Reel



SS1040HE SERIES

Part No_packing code_Version

SS1040HE_R1_00001

SS1040HE_R2_00001

For example :

RB500V-40_R2_00001

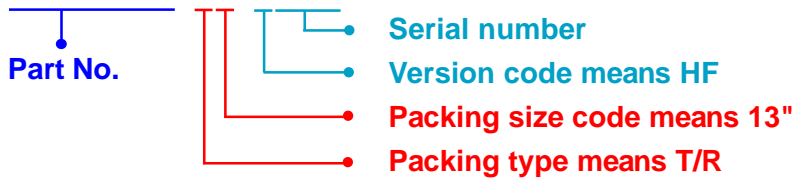

Packing Code XX				Version Code XXXXX		
Packing type	1 st Code	Packing size code	2 nd Code	HF or RoHS	1 st Code	2 nd ~5 th Code
Tape and Ammunition Box (T/B)	A	N/A	0	HF	0	serial number
Tape and Reel (T/R)	R	7"	1	RoHS	1	serial number
Bulk Packing (B/P)	B	13"	2			
Tube Packing (T/P)	T	26mm	X			
Tape and Reel (Right Oriented) (TRR)	S	52mm	Y			
Tape and Reel (Left Oriented) (TRL)	L	PANASERT T/B CATHODE UP (PBCU)	U			
FORMING	F	PANASERT T/B CATHODE DOWN (PBCD)	D			



SS1040HE SERIES

Disclaimer

- Reproducing and modifying information of the document is prohibited without permission from Panjit International Inc..
- Panjit International Inc. reserves the rights to make changes of the content herein the document anytime without notification. Please refer to our website for the latest document.
- Panjit International Inc. disclaims any and all liability arising out of the application or use of any product including damages incidentally and consequentially occurred.
- Panjit International Inc. does not assume any and all implied warranties, including warranties of fitness for particular purpose, non-infringement and merchantability.
- Applications shown on the herein document are examples of standard use and operation. Customers are responsible in comprehending the suitable use in particular applications. Panjit International Inc. makes no representation or warranty that such applications will be suitable for the specified use without further testing or modification.
- The products shown herein are not designed and authorized for equipments requiring high level of reliability or relating to human life and for any applications concerning life-saving or life-sustaining, such as medical instruments, transportation equipment, aerospace machinery et cetera. Customers using or selling these products for use in such applications do so at their own risk and agree to fully indemnify Panjit International Inc. for any damages resulting from such improper use or sale.
- Since Panjit uses lot number as the tracking base, please provide the lot number for tracking when complaining.

Mouser Electronics

Authorized Distributor

Click to View Pricing, Inventory, Delivery & Lifecycle Information:

[Panjit:](#)

[SS10200HE_R2_00001](#) [SS10200HE_R2_10001](#) [SS10200HE_R1_00001](#) [SS10200HE_R1_10001](#)