

IEC Appliance Inlet C14 with Filter, Fuseholder 1-pole



Screw-on from front side
 Type 5200, Fuseholder 1-pole with spare compartment
 Screw-On Version

Snap-in mounting from front side
 Type 5200, Fuseholder 1-pole with spare compartment
 Snap-In Version



See below:
[Approvals and Compliances](#)

Description

- Panel mount :
 Snap-in or screw-on mounting from front side
- 3 Functions :
 Appliance Inlet Protection class I , Fuseholder for fuse-links 5 x 20 mm 1-pole , Line filter in standard and medical version
- V-Lock notch standard
- Quick connect terminals 6.3 x 0.8 mm

Unique Selling Proposition

- Ultra-compact design
- Recessed faston connectors
- High quality filter case made of stainless steel
- Highly resistant since potted filter

Characteristics

- All single elements are already wired
- Plug removal necessary for fuse-link replacement
- For applications according IEC/UL 62368-1 we recommend variants with bleed resistor
 Standard and Medical Version, IEC 60939-2, UL 60939-3

Other versions on request

- Medical Version (M80)

References

Alternative: version without line filter [6200](#)
 Alternative: Standard version

Weblinks

[pdf data sheet](#), [html datasheet](#), [General Product Information](#), [Approvals](#), [Distributor-Stock-Check](#), [Accessories](#), [Detailed request for product](#)

Technical Data

Ratings IEC	1 - 10A @ Ta 40 °C / 250VAC; 50Hz	Appliance inlet/-outlet	C14 acc. to IEC 60320-1, UL 60320-1, CSA C22.2 no. 60320-1 (for cold conditions) pin-temperature 70 °C, 10A, Protection Class I
Ratings UL/CSA	1 - 10A @ Ta 40 °C / 250VAC; 60Hz	Fuseholder	1-pole, Shocksafe category PC2 acc. to IEC 60127-6, for fuse-links 5 x 20mm
Leakage Current	standard < 0.5mA (250V / 60Hz) medical < 5 µA (250 V / 60 Hz)	Rated Power Acceptance @ Ta 23 °C	5 x 20: 2W (1 pole)
Dielectric Strength	> 1.7kVDC between L-N > 2.7kVDC between L/N-PE Test voltage (2sec)	Power Acceptance @ Ta > 23°C	Admissible power acceptance at higher ambient temperature see derating curves
Allowable Operation Temperature	-25 °C to 85 °C	Line Filter	Standard and Medical Version, IEC 60939-2, UL 60939-3, CSA C22.2 no. 8 Technical Details
Climatic Category	25/085/21 acc. to IEC 60068-1	MTBF	> 2'300'000h acc. to MIL-HB-217 F
IP-Protection	from front side IP40 acc. to IEC 60529		
Protection Class	Suitable for appliances with protection class I acc. to IEC 61140		
Terminal	Quick connect terminals 6.3 x 0.8 mm		
Panel Thickness S	Screw: max 8mm Mounting screw torque max 0.5Nm Snap-in: 0.8mm to 3mm		
Material: Housing	Thermoplastic, black, UL 94V-0		

Approvals and Compliances



Detailed information on product approvals, code requirements, usage instructions and detailed test conditions can be looked up in [Details about Approvals](#)

SCHURTER products are designed for use in industrial environments. They have approvals from independent testing bodies according to national and international standards. Products with specific characteristics and requirements such as required in the automotive sector according to IATF 16949, medical technology according to ISO 13485 or in the aerospace industry can be offered exclusively with customer-specific, individual agreements by SCHURTER.

Approvals







The approval mark is used by the testing authorities to certify compliance with the safety requirements placed on electronic products.

Approval Reference Type: 5200

Approval Logo	Certificates	Certification Body	Description
	VDE Approvals	VDE	Certificate Number: 101307
	UL Approvals	UL	UL File Number: E495089
	CQC Approvals	CQC	CQC Certificate Number: CQC18001210262



Product standards

Product standards that are referenced

Organization	Design	Standard	Description
	Designed according to	IEC 60320-1	Appliance couplers for household and similar general purposes
	Designed according to	IEC 60939-2	Passive filters for suppressing electromagnetic interference
	Designed according to	IEC 60127-6	Miniature fuses. Part 6. Fuse-holders for miniature fuse-links
	Designed according to	UL 60320-1	Standard for Attachment Plugs and Receptacles
	Designed according to	UL 60939-3	Electromagnetic interference filters
	Designed according to	CSA C22.2 no. 60320-1	General Use Receptacles, Attachment Plugs, and Similar Wiring Devices
	Designed according to	CSA C22.2 no. 8	Electromagnetic interference (EMI) filters







Application standards

Application standards where the product can be used

Organization	Design	Standard	Description
	Designed for applications acc.	IEC/UL 62368-1	IEC 62368-1 includes the basic requirements for safety of audio, video, information technology and office equipment.
	Designed for applications acc.	IEC 60601-1	Medical electrical equipment - Part 1: General requirements for basic safety and essential performance
	Designed for applications acc.	IEC 60335-1	Safety of electrical appliances for household and similar purposes. Meets the requirements for appliances in unattended use. This includes the enhanced requirements of glow wire tests acc. to IEC 60695-2-11 or -12 & -13.

Compliances

The product complies with following Guide Lines

Identification	Details	Initiator	Description
	CE declaration of conformity	SCHURTER AG	The CE marking declares that the product complies with the applicable requirements laid down in the harmonisation of Community legislation on its affixing in accordance with EU Regulation 765/2008.
	RoHS	SCHURTER AG	Directive RoHS 2011/65/EU, Amendment (EU) 2015/863
	China RoHS	SCHURTER AG	The law SJ / T 11363-2006 (China RoHS) has been in force since 1 March 2007. It is similar to the EU directive RoHS.
	REACH	SCHURTER AG	On 1 June 2007, Regulation (EC) No 1907/2006 on the Registration, Evaluation, Authorization and Restriction of Chemicals 1 (abbreviated as "REACH") entered into force.
		SCHURTER AG	V-Lock system are based on a matching plug-dose combination. The connector is equipped with a notch intended for use with the latching cordset. The cord latching system prevents against accidental removal of the cordset.
	White Paper Glow wire test	SCHURTER AG	Meets the requirements of IEC 60335-1 for appliances in unattended use. This includes the enhanced requirements of glow wire tests acc. to IEC 60695-2-11 or -12 & -13.
	Medical Equipment	SCHURTER AG	Suitable for use in medical equipment according to IEC/UL 60601-1

Dimension [mm]

Screw-on mounting type 5200

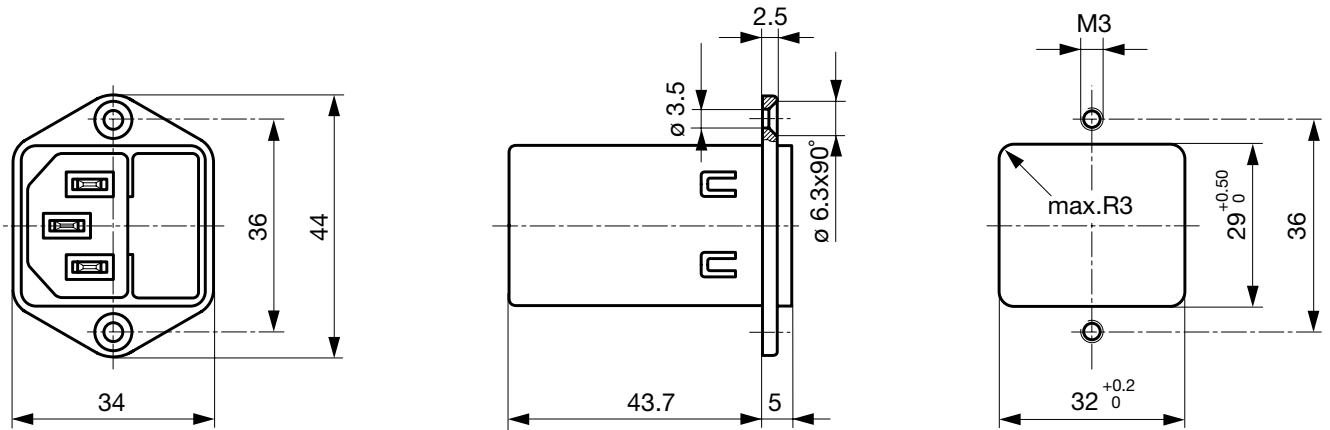

Snap-in mounting type 5200

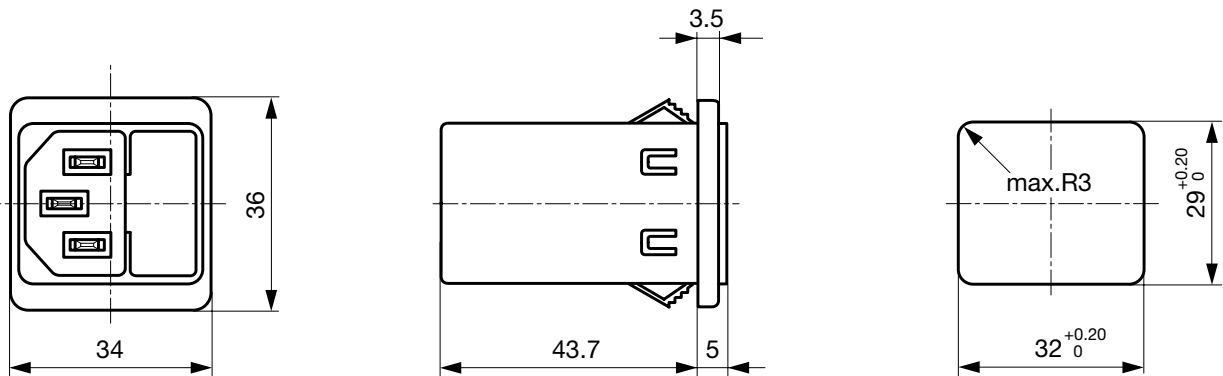

Technical Data of Filter-Components

Rated Current [A]	Filter-Type	Inductances L [mH]	Capacitance CX [nF]	Capacitance CY [nF]	R [MΩ]
1	Standard version	2 x 11	47	2.2	-
2	Standard version	2 x 4	47	2.2	-
4	Standard version	2 x 1.6	47	2.2	-
6	Standard version	2 x 0.7	47	2.2	-
8	Standard version	2 x 0.6	47	2.2	-
10	Standard version	2 x 0.4	47	2.2	-
1	Medical Version (M5)	2 x 11	47	-	1
2	Medical Version (M5)	2 x 4	47	-	1
4	Medical Version (M5)	2 x 1.6	47	-	1
6	Medical Version (M5)	2 x 0.7	47	-	1
8	Medical Version (M5)	2 x 0.6	47	-	1
10	Medical Version (M5)	2 x 0.4	47	-	1
10	Standard and Medical Version	2 x 11	47	2.2	1

Diagrams

5200 Standard Version

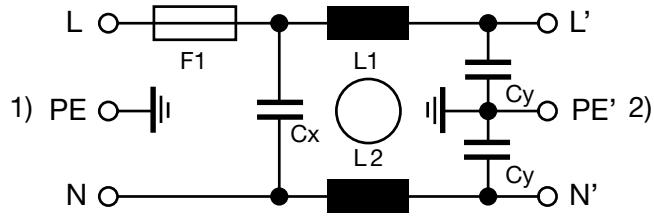

1) Line
 2) Load

5200 Medical Version (M5)

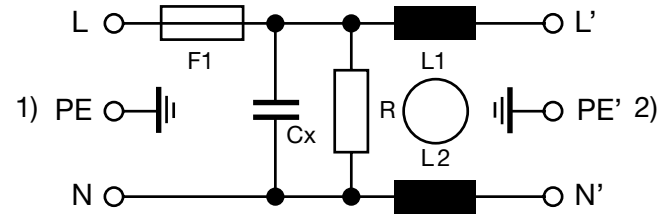

1) Line
 2) Load

Derating Curves

1-pole

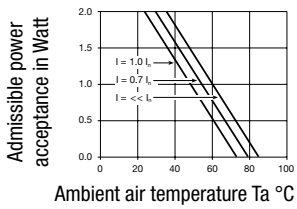

Attenuation Loss

--- 50Ω differential mode ___ 50Ω common mode

Standard version



Medical version (M5)

1 A



2 A

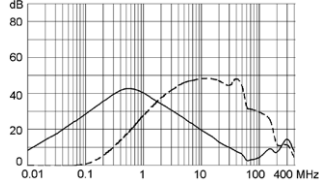

4 A

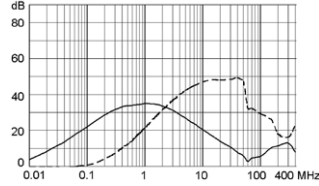

6 A

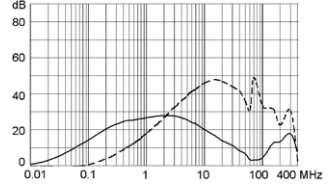

8 A

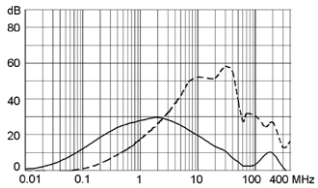

10 A

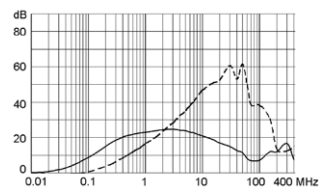

All Variants

Rated Current [A]	Filter-Type	Panel mounting	Fuseholder	Order Number	
1	Standard version	Snap-in	1-pole	5200.0143.1	■
2	Standard version	Snap-in	1-pole	5200.0243.1	■
4	Standard version	Snap-in	1-pole	5200.0443.1	■
6	Standard version	Snap-in	1-pole	5200.0643.1	■
8	Standard version	Snap-in	1-pole	5200.0843.1	
10	Standard version	Snap-in	1-pole	5200.1043.1	■
1	Standard version	Screw	1-pole	5200.0123.1	■
2	Standard version	Screw	1-pole	5200.0223.1	■
4	Standard version	Screw	1-pole	5200.0423.1	■
6	Standard version	Screw	1-pole	5200.0623.1	■
8	Standard version	Screw	1-pole	5200.0823.1	
10	Standard version	Screw	1-pole	5200.1023.1	■
1	Medical Version (M5)	Snap-in	1-pole	5200.0143.3	
2	Medical Version (M5)	Snap-in	1-pole	5200.0243.3	
4	Medical Version (M5)	Snap-in	1-pole	5200.0443.3	
6	Medical Version (M5)	Snap-in	1-pole	5200.0643.3	
8	Medical Version (M5)	Snap-in	1-pole	5200.0843.3	
10	Medical Version (M5)	Snap-in	1-pole	5200.1043.3	
1	Medical Version (M5)	Screw	1-pole	5200.0123.3	
2	Medical Version (M5)	Screw	1-pole	5200.0223.3	
4	Medical Version (M5)	Screw	1-pole	5200.0423.3	
6	Medical Version (M5)	Screw	1-pole	5200.0623.3	■
8	Medical Version (M5)	Screw	1-pole	5200.0823.3	
10	Medical Version (M5)	Screw	1-pole	5200.1023.3	

■ Most Popular.

Availability for all products can be searched real-time: <https://www.schurter.com/en/Stock-Check/Stock-Check-SCHURTER>

Packaging unit

10 Pcs

Accessories

Description

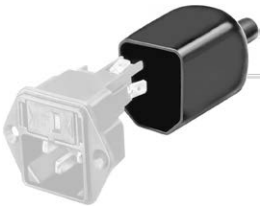

Assorted Covers
 Rear Cover

0859.0047



RC320
 Rear Cover for Power Entry Module



Cord retaining kits
 Cord retaining strain relief

Countersunk, B

4700.0002

Mating Outlets/Connectors

Category / Description

Appliance Outlet Overview complete



4787, Mounting: Screw-on mounting, Appliance Outlet: IEC Solder terminals, 10 A, Suitable for appliances with protection class I

4787

4788, Mounting: Snap-in version, Appliance Outlet: IEC Solder/Quick Connect Terminal, 10 A, Suitable for appliances with protection class I

4788

IEC Appliance Outlet F or H, Screw-on Mounting, Front Side, Solder, PCB or Quick-connect Terminal

5091

Connector Overview complete



4782 Mounting: Power Cord, 3 x 1 mm² / 3 x 18 AWG, Cable, Connector: IEC C13

4782

4785 Mounting: Power Cord, 3 x 1 mm² / 3 x 18 AWG, Cable, Connector: IEC C13

4785

4300-06 Mounting: Power Cord, 3 x 1 mm² / 3 x 18 AWG, Cable, Connector: IEC C13

4300-06

4781 Mounting: Power Cord, Cable, Connector: IEC C15

4781

4784 Mounting: Power Cord, 3 x 1 mm² / 3 x 18 AWG, Cable, Connector: IEC C15

4784

...

Mating Outlets/Connectors shuttered



Connector Overview complete

4783 Mounting: Power Cord, 3 x 1 mm² / 3 x 18 AWG, Cable, Connector: IEC C13

4783

Mouser Electronics

Authorized Distributor

Click to View Pricing, Inventory, Delivery & Lifecycle Information:

Schurter:

[5200.1023.3](#) [5200.1023.1](#) [5200.1043.1](#) [5200.0143.1](#) [5200.0423.1](#) [5200.0623.1](#) [5200.0643.1](#) [5200.0123.1](#)
[5200.0443.3](#) [5200.0443.1](#) [5200.0123.3](#) [5200.0143.3](#) [5200.0223.3](#) [5200.0243.3](#) [5200.0423.3](#) [5200.0423.5](#)
[5200.0623.3](#) [5200.0823.1](#) [5200.1043.3](#) [5200.0643.3](#) [5200.0843.1](#) [5200.0243.1](#) [5200.0223.1](#) [5200.0823.3](#)