

# MOSFET

## StrongIRFET™

### Applications

- UPS and Inverter applications
- Half-bridge and full-bridge topologies
- Resonant mode power supplies
- DC/DC and AC/DC converters
- OR-ing and redundant power switches
- Brushed and BLDC Motor drive applications
- Battery powered circuits

### Benefits

- Improved Gate, Avalanche and Dynamic dv/dt Ruggedness
- Fully Characterized Capacitance and Avalanche SOA
- Enhanced body diode dv/dt and di/dt Capability
- Pb-Free ; RoHS Compliant ; Halogen-Free

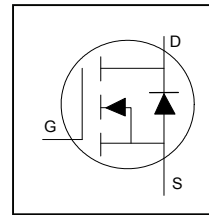

<b>V<sub>DSS</sub></b>	<b>200V</b>
<b>R<sub>DS(on) typ.</sub></b>	<b>9.5mΩ</b>
	<b>max</b>
<b>I<sub>D</sub></b>	<b>100A</b>

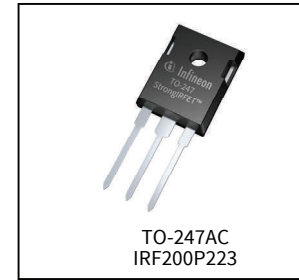

<b>G</b>	<b>D</b>	<b>S</b>
Gate	Drain	Source



Base part number	Package Type	Standard Pack		Orderable Part Number
		Form	Quantity	
IRF200P223	TO-247AC	Tube	25	IRF200P223

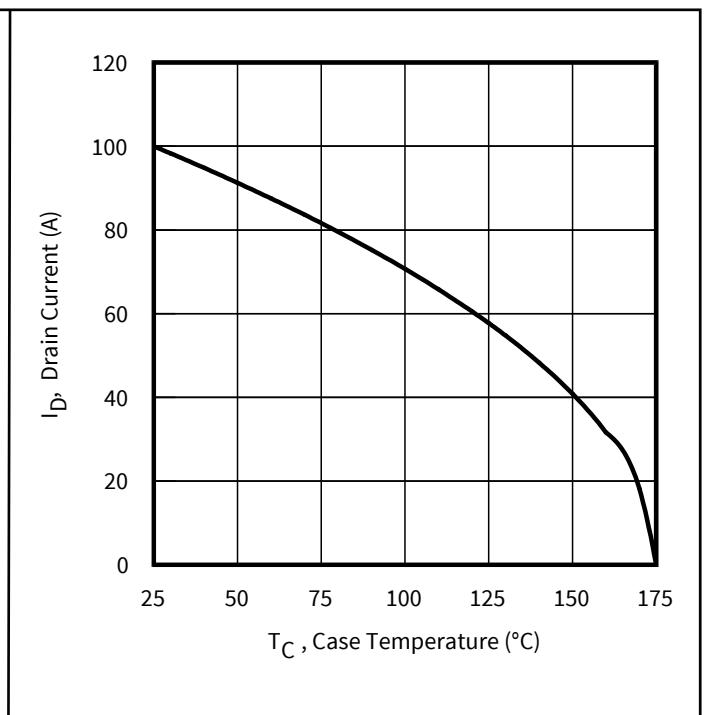
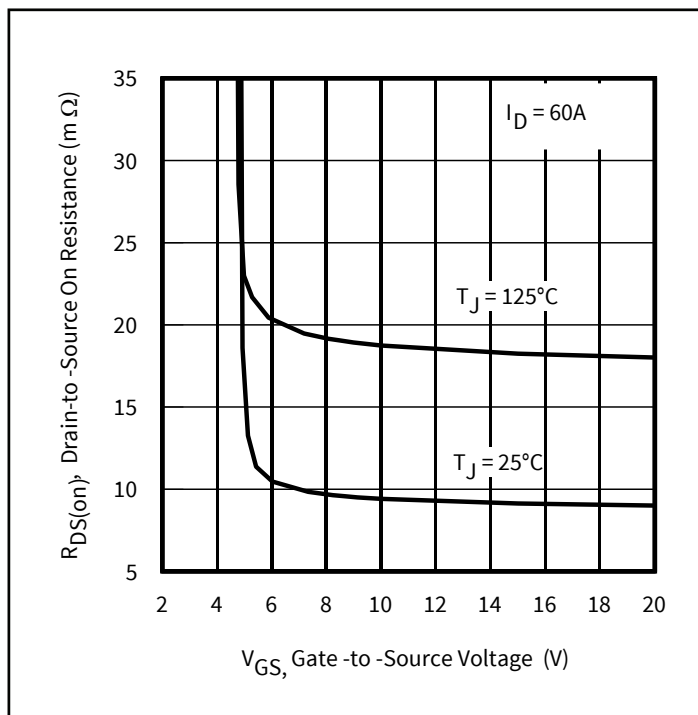

Figure 1 Typical On-Resistance vs. Gate Voltage

Figure 2 Maximum Drain Current vs. Case Temperature

**Table of Contents**

**Applications .....1**

**Benefits .....1**

**Ordering Table .....1**

**Table of Contents .....2**

**1 Parameters .....3**

**2 Maximum ratings, Thermal, and Avalanche characteristics .....4**

**3 Electrical characteristics .....5**

**4 Electrical characteristic diagrams .....6**

**Package Information .....14**

**Qualification Information .....15**

**Revision History .....16**

## 1 Parameters

**Table1 Key performance parameters**

Parameter	Values	Units
$V_{DS}$	200	V
$R_{DS(on) max}$	11.5	m $\Omega$
$I_D$	100	A

## 2 Maximum ratings and thermal characteristics

**Table 2 Maximum ratings (at  $T_J=25^\circ\text{C}$ , unless otherwise specified)**

Parameter	Symbol	Conditions	Values	Unit
Continuous Drain Current	$I_D$	$T_C = 25^\circ\text{C}$ , $V_{GS} @ 10\text{V}$	100	A
Continuous Drain Current	$I_D$	$T_C = 100^\circ\text{C}$ , $V_{GS} @ 10\text{V}$	71	
Pulsed Drain Current ①	$I_{DM}$	$T_C = 25^\circ\text{C}$	400	
Maximum Power Dissipation	$P_D$	$T_C = 25^\circ\text{C}$	313	W
Linear Derating Factor		$T_C = 25^\circ\text{C}$	2.1	W/ $^\circ\text{C}$
Gate-to-Source Voltage	$V_{GS}$	-	$\pm 20$	V
Operating Junction and Storage Temperature Range	$T_J$ $T_{STG}$	-	-55 to +175	$^\circ\text{C}$
Soldering Temperature, for 10 seconds (1.6mm from case)	-	-	300	
Mounting Torque, 6-32 or M3 Screw	-	-	10 lbf·in (1.1 N·m)	

**Table 3 Thermal characteristics**

Parameter	Symbol	Conditions	Min.	Typ.	Max.	Unit
Junction-to-Case ⑦	$R_{\theta JC}$	$T_J$ approximately $90^\circ\text{C}$	-	-	0.48	$^\circ\text{C}/\text{W}$
Case-to-Sink, Flat Greased Surface	$R_{\theta CS}$	-	-	0.24	-	
Junction-to-Ambient	$R_{\theta JA}$	-	-	-	40	

**Table 4 Avalanche characteristics**

Parameter	Symbol	Values	Unit
Single Pulse Avalanche Energy ②	$E_{AS}$ (Thermally limited)	429	mJ
Single Pulse Avalanche Energy ⑧	$E_{AS}$ (Thermally limited)	541	
Avalanche Current ①	$I_{AR}$	See Fig 16, 17, 23a, 23b	A
Repetitive Avalanche Energy ①	$E_{AR}$		mJ

**Notes:**

- ① Repetitive rating; pulse width limited by max. junction temperature.
- ② Limited by  $T_{Jmax}$ , starting  $T_J = 25^\circ\text{C}$ ,  $L = 0.24\text{mH}$ ,  $R_G = 50\Omega$ ,  $I_{AS} = 60\text{A}$ ,  $V_{GS} = 10\text{V}$ .
- ③  $I_{SD} \leq 60\text{A}$ ,  $di/dt \leq 2330\text{A}/\mu\text{s}$ ,  $V_{DD} \leq V_{(BR)DSS}$ ,  $T_J \leq 175^\circ\text{C}$ .
- ④ Pulse width  $\leq 400\mu\text{s}$ ; duty cycle  $\leq 2\%$ .
- ⑤  $C_{oss}$  eff. (TR) is a fixed capacitance that gives the same charging time as  $C_{oss}$  while  $V_{DS}$  is rising from 0 to 80%  $V_{DSS}$ .
- ⑥  $C_{oss}$  eff. (ER) is a fixed capacitance that gives the same energy as  $C_{oss}$  while  $V_{DS}$  is rising from 0 to 80%  $V_{DSS}$ .
- ⑦  $R_\theta$  is measured at  $T_J$  approximately  $90^\circ\text{C}$ .
- ⑧ Limited by  $T_{Jmax}$ , starting  $T_J = 25^\circ\text{C}$ ,  $L = 1\text{mH}$ ,  $R_G = 50\Omega$ ,  $I_{AS} = 33\text{A}$ ,  $V_{GS} = 10\text{V}$ .

### 3 Electrical characteristics

**Table 5 Static characteristics**

Parameter	Symbol	Conditions	Values			Unit
			Min.	Typ.	Max.	
Drain-to-Source Breakdown Voltage	$V_{(BR)DSS}$	$V_{GS} = 0V, I_D = 1mA$	200	-	-	V
Breakdown Voltage Temp. Coefficient	$\Delta V_{(BR)DSS}/\Delta T_J$	Reference to 25°C, $I_D = 1mA$ ①	-	0.10	-	V/°C
Static Drain-to-Source On-Resistance	$R_{DS(on)}$	$V_{GS} = 10V, I_D = 60A$	-	9.5	11.5	mΩ
Gate Threshold Voltage	$V_{GS(th)}$	$V_{DS} = V_{GS}, I_D = 270\mu A$	2.0	-	4.0	V
Drain-to-Source Leakage Current	$I_{DSS}$	$V_{DS} = 160V, V_{GS} = 0V$	-	-	1.0	μA
		$V_{DS} = 160V, V_{GS} = 0V, T_J = 125^\circ C$	-	-	100	
Gate-to-Source Forward Leakage	$I_{GSS}$	$V_{GS} = 20V$	-	-	100	nA
Gate Resistance	$R_G$		-	2.7	-	Ω

**Table 6 Dynamic characteristics**

Parameter	Symbol	Conditions	Values			Unit
			Min.	Typ.	Max.	
Forward Trans conductance	gfs	$V_{DS} = 50V, I_D = 60A$	93	-	-	S
Total Gate Charge	$Q_g$	$I_D = 60A$ $V_{DS} = 100V$ $V_{GS} = 10V$	-	68	102	nC
Gate-to-Source Charge	$Q_{gs}$		-	25	-	
Gate-to-Drain Charge	$Q_{gd}$		-	13	-	
Total Gate Charge Sync. ( $Q_g - Q_{gd}$ )	$Q_{sync}$		-	55	-	
Turn-On Delay Time	$t_{d(on)}$	$V_{DD} = 130V$	-	16	-	ns
Rise Time	$t_r$	$I_D = 60A$	-	66	-	
Turn-Off Delay Time	$t_{d(off)}$	$R_G = 2.7\Omega$	-	55	-	
Fall Time	$t_f$	$V_{GS} = 10V$	-	62	-	
Input Capacitance	$C_{iss}$	$V_{GS} = 0V$	-	5094	-	pF
Output Capacitance	$C_{oss}$	$V_{DS} = 50V$	-	628	-	
Reverse Transfer Capacitance	$C_{rss}$	$f = 1.0MHz$ , See Fig.7	-	8.7	-	
Effective Output Capacitance (Energy Related)	$C_{oss\ eff.(ER)}$	$V_{GS} = 0V, V_{DS} = 0V$ to 160V ⑥	-	537	-	
Output Capacitance (Time Related)	$C_{oss\ eff.(TR)}$	$V_{GS} = 0V, V_{DS} = 0V$ to 160V ⑤	-	783	-	

**Table 7 Reverse Diode**

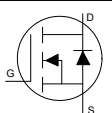
Parameter	Symbol	Conditions	Values			Unit
			Min.	Typ.	Max.	
Continuous Source Current (Body Diode)	$I_S$	MOSFET symbol showing the integral reverse p-n junction diode. 	-	-	100	A
Pulsed Source Current (Body Diode) ①	$I_{SM}$		-	-	400	
Diode Forward Voltage	$V_{SD}$	$T_J = 25^\circ C, I_S = 60A, V_{GS} = 0V$ ④	-	-	1.2	V
Peak Diode Recovery $dv/dt$ ③	$dv/dt$	$T_J = 175^\circ C, I_S = 60A, V_{DS} = 200V$	-	15	-	V/ns
Reverse Recovery Time	$t_{rr}$	$T_J = 25^\circ C$ $V_{DD} = 170V$	-	105	-	ns
		$T_J = 125^\circ C$ $I_F = 60A,$	-	150	-	
Reverse Recovery Charge	$Q_{rr}$	$T_J = 25^\circ C$ $di/dt = 100A/\mu s$ ④	-	283	-	nC
		$T_J = 125^\circ C$	-	580	-	
Reverse Recovery Current	$I_{RRM}$	$T_J = 25^\circ C$	-	4.1	-	A

## 4 Electrical characteristic diagrams

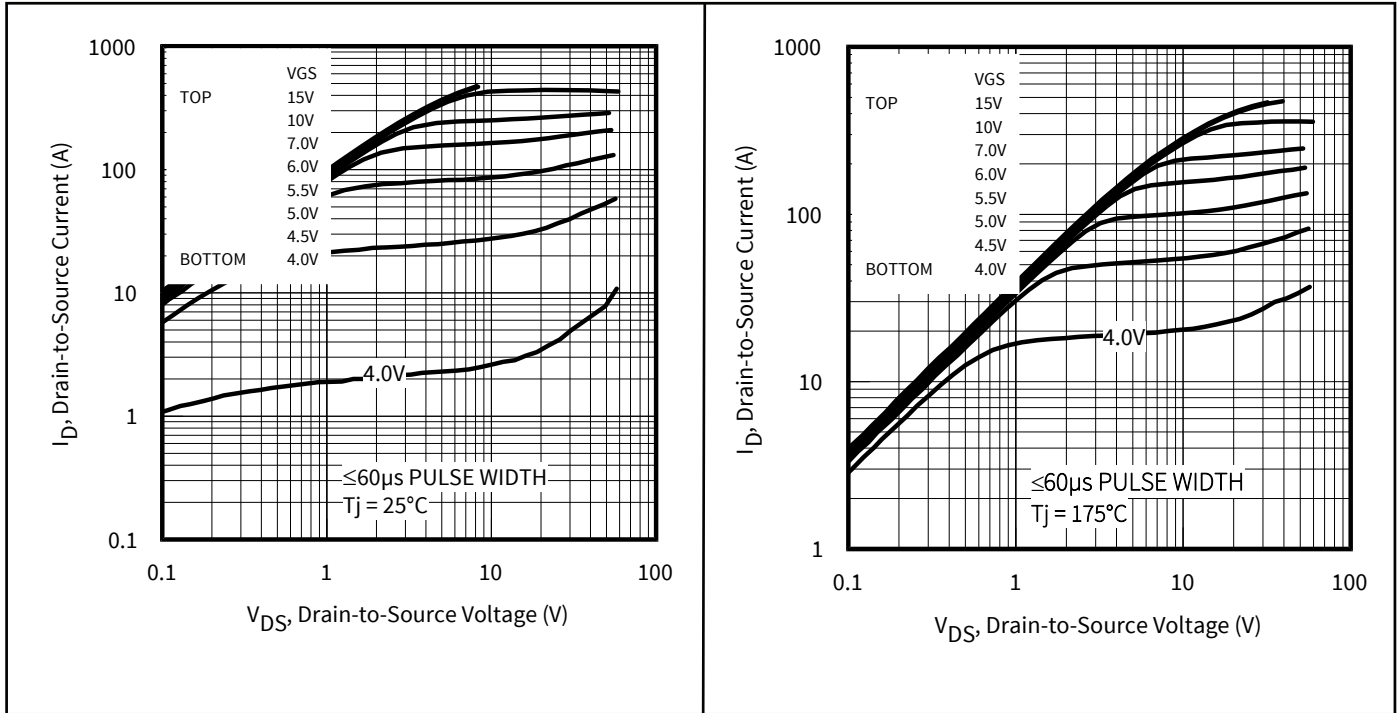

Figure 3 Typical Output Characteristics

Figure 4 Typical Output Characteristics

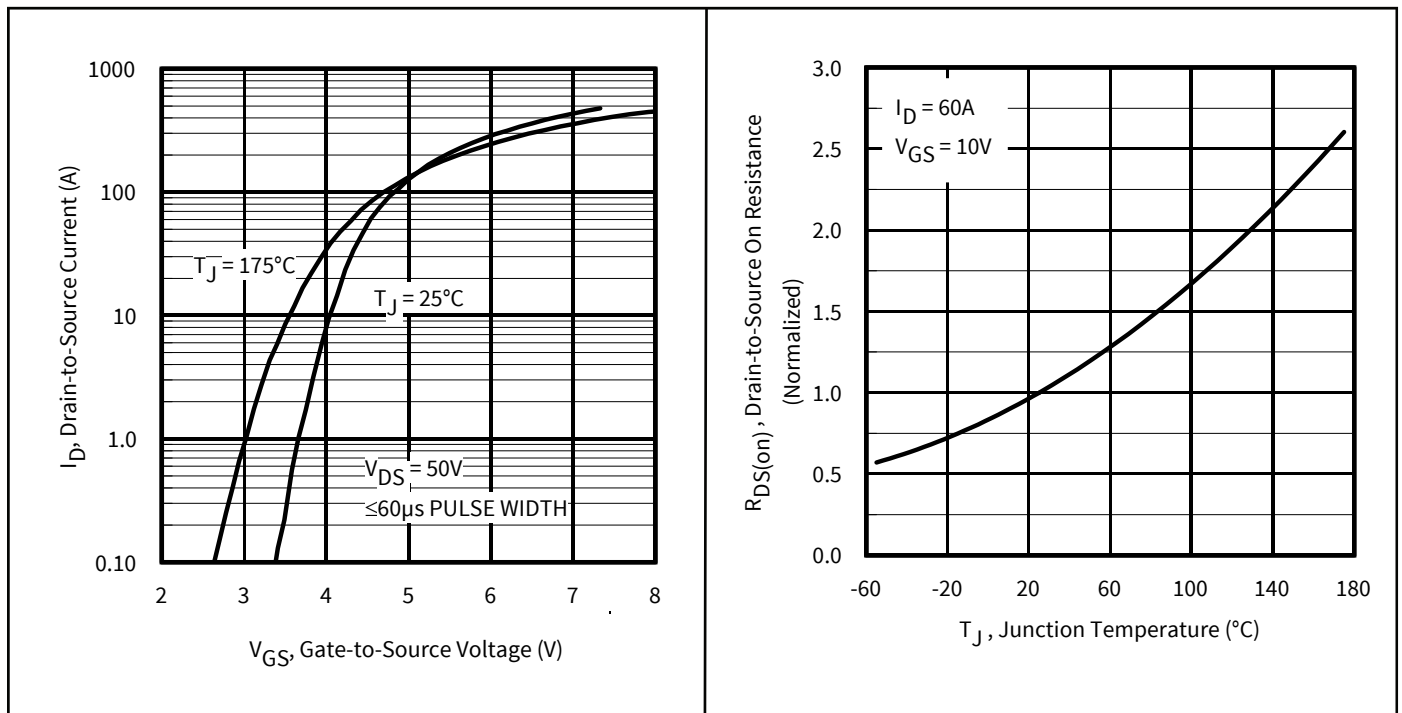

Figure 5 Typical Transfer Characteristics

Figure 6 Normalized On-Resistance vs. Temperature

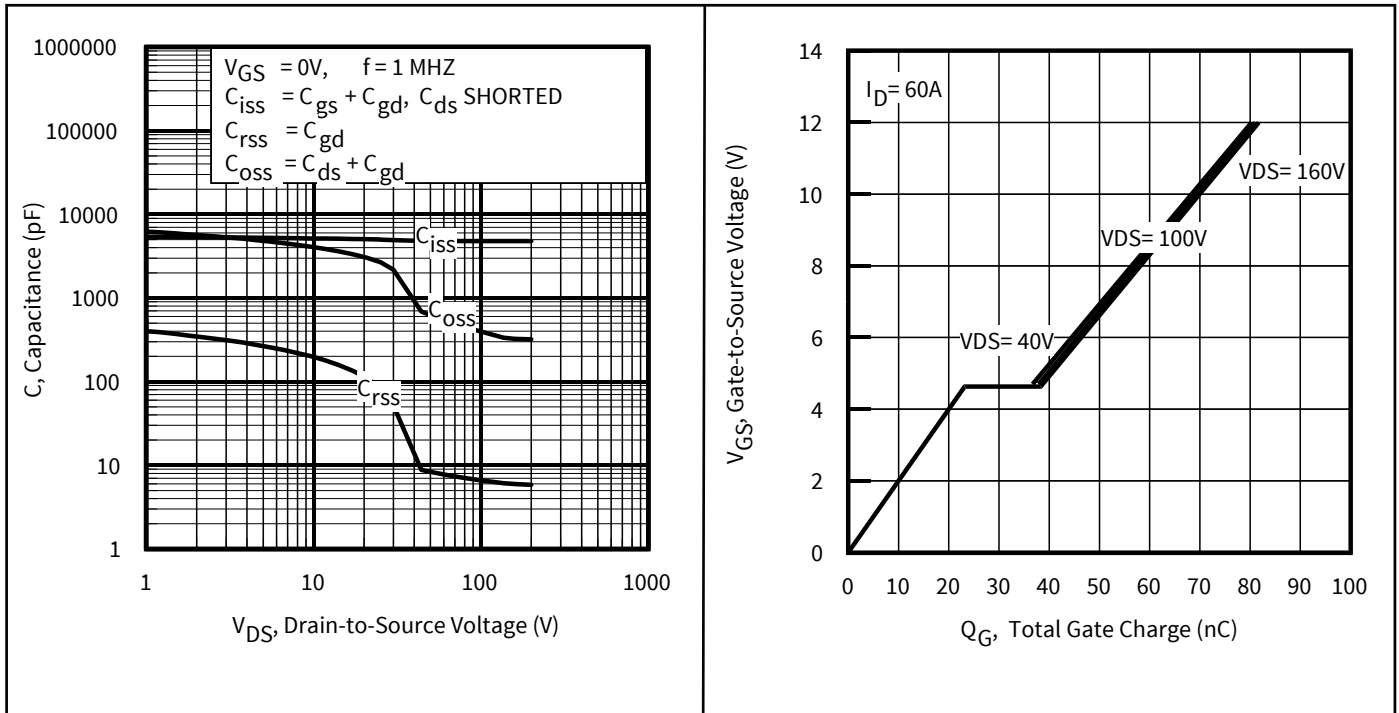

Figure 7 Typical Capacitance vs. Drain-to-Source Voltage

Figure 8 Typical Gate Charge vs. Gate-to-Source Voltage

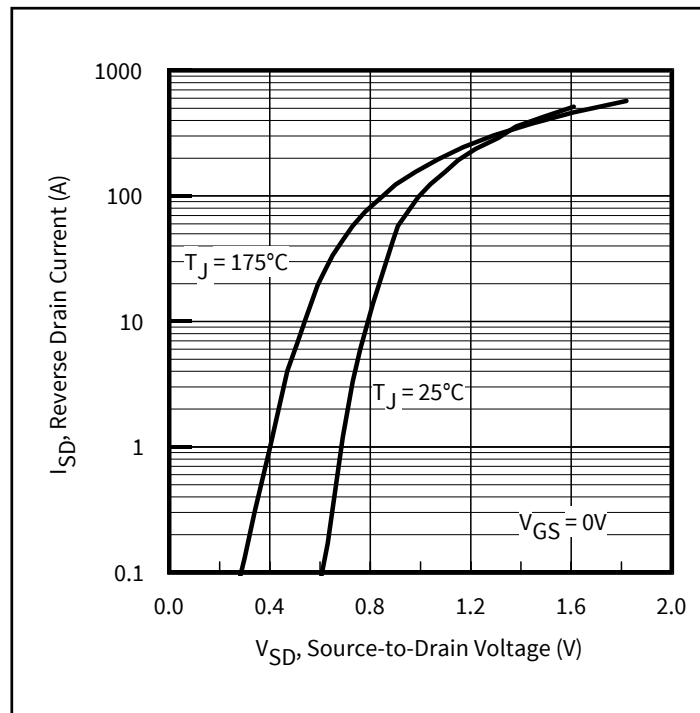

Figure 9 Typical Source-Drain Diode Forward Voltage

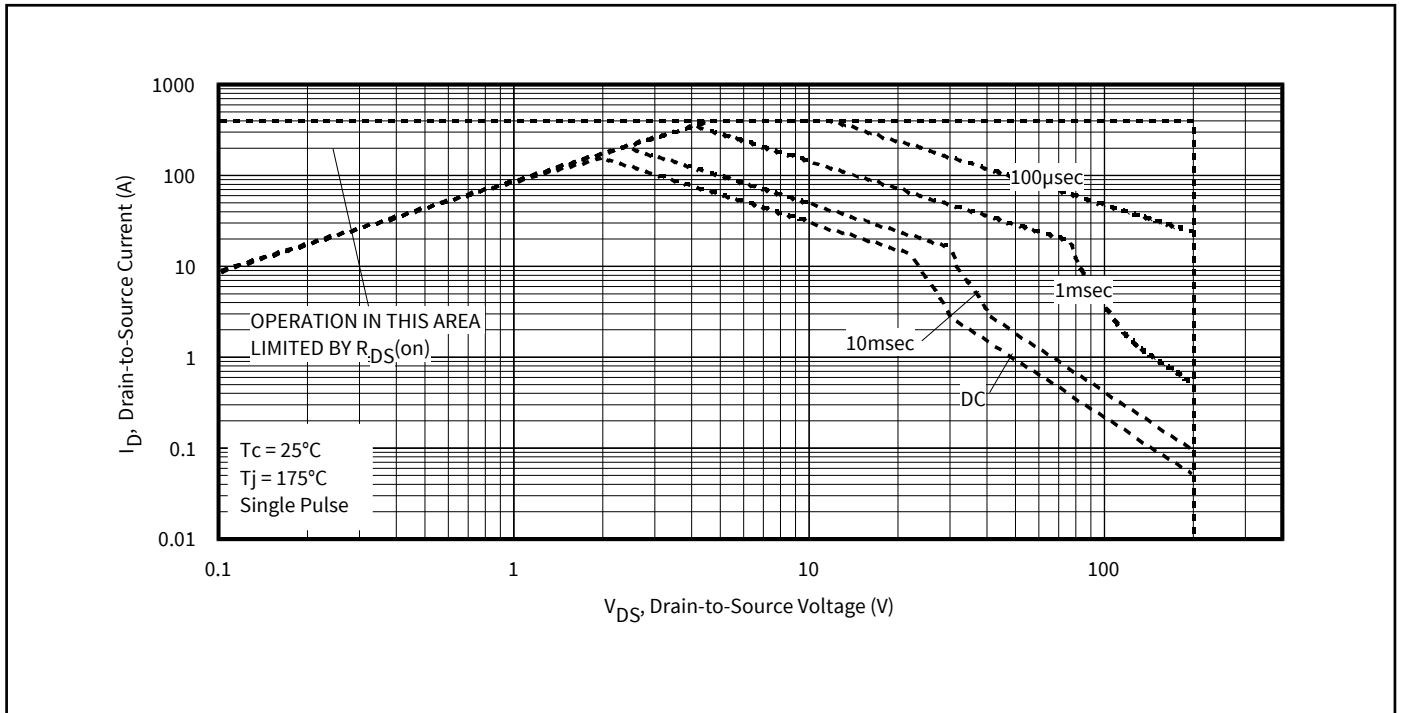

Figure 10 Maximum Safe Operating Area

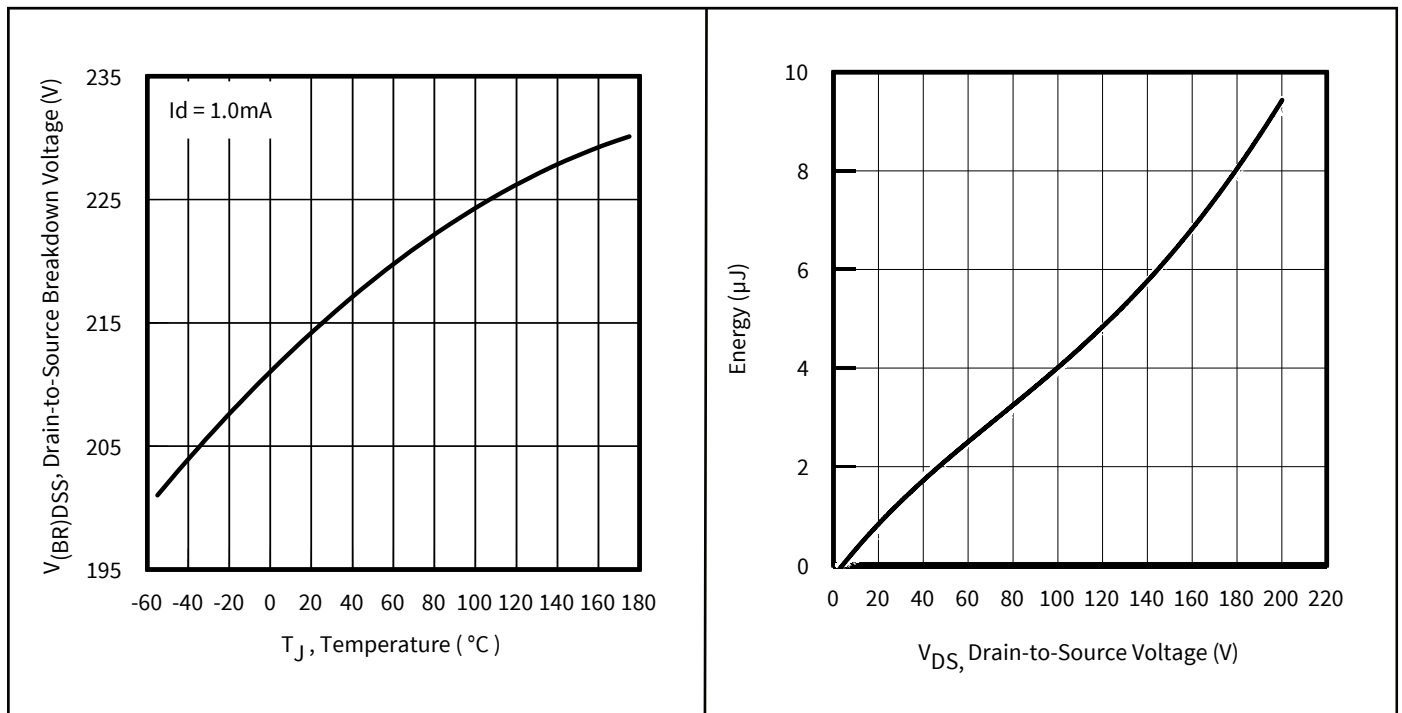

Figure 11 Drain-to-Source Breakdown Voltage

Figure 12 Typical Coss Stored Energy



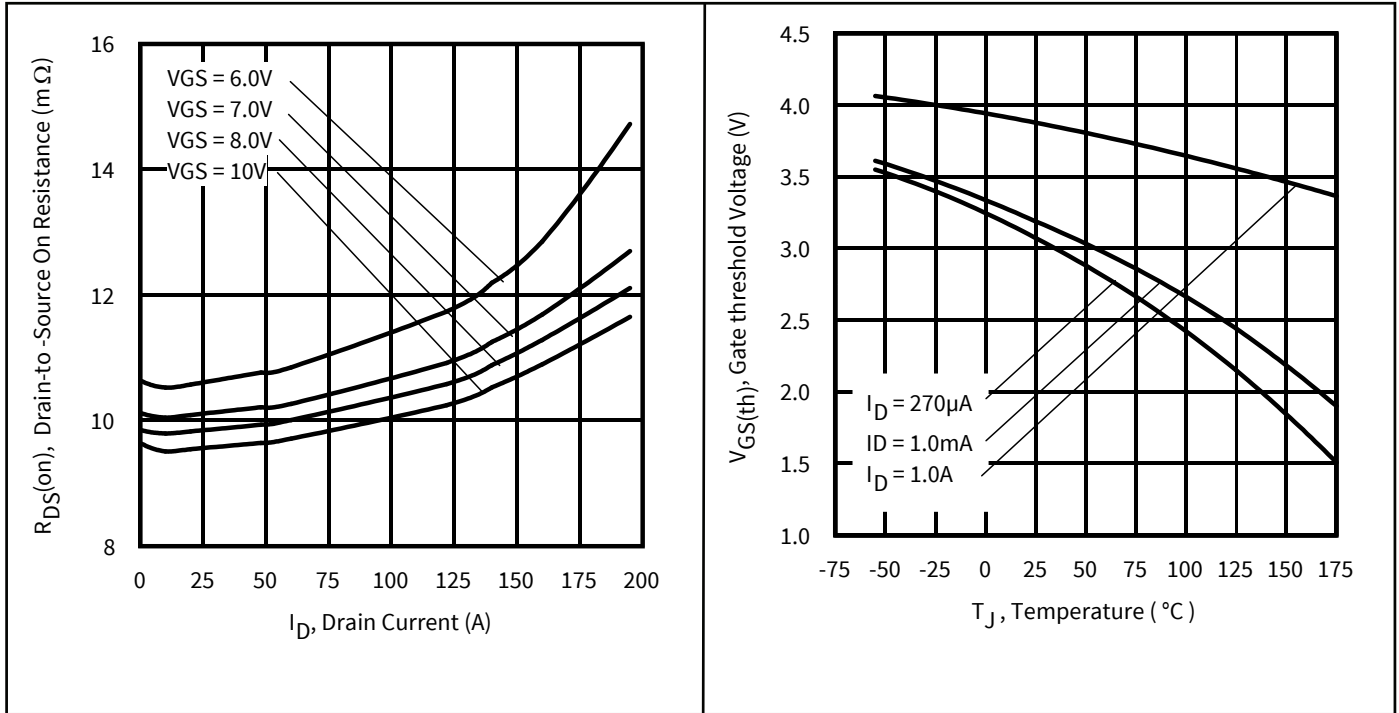

Figure 13 Typical On-Resistance vs. Drain Current

Figure 14 Threshold Voltage vs. Temperature

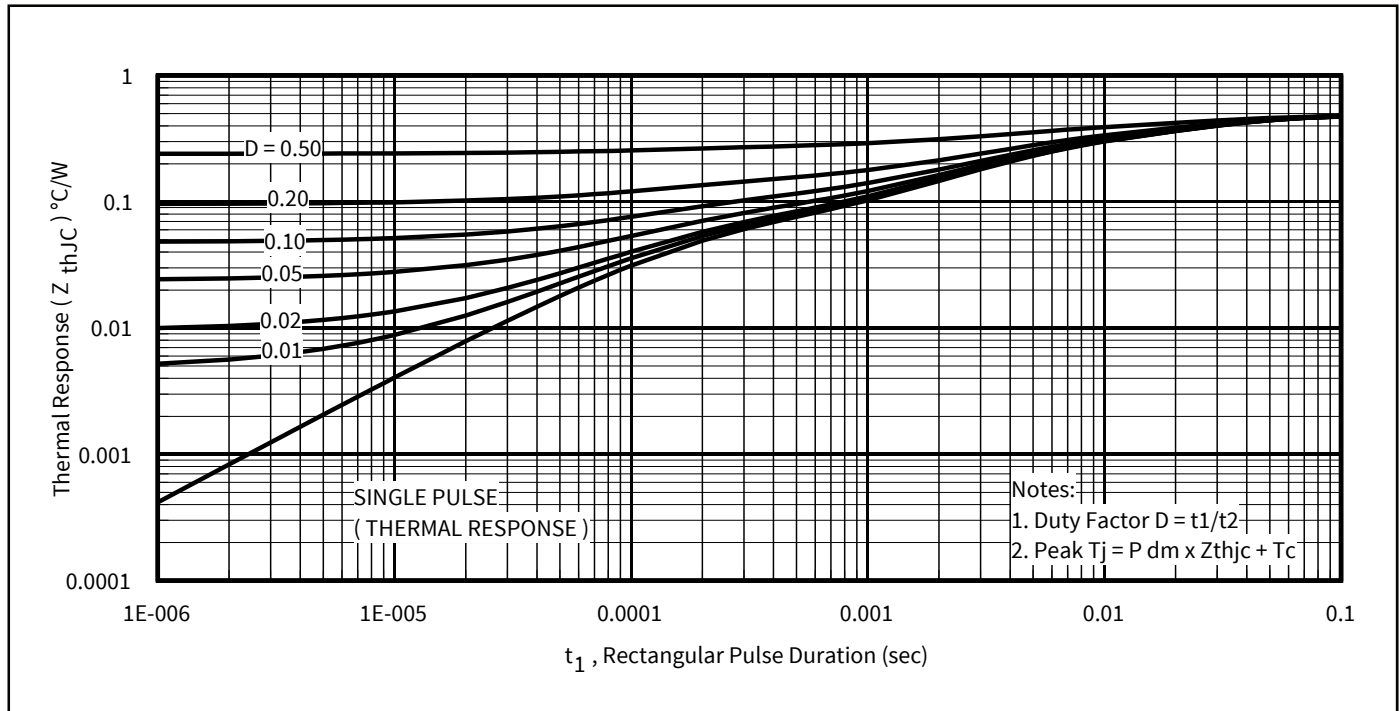

Figure 15 Maximum Effective Transient Thermal Impedance, Junction-to-Case

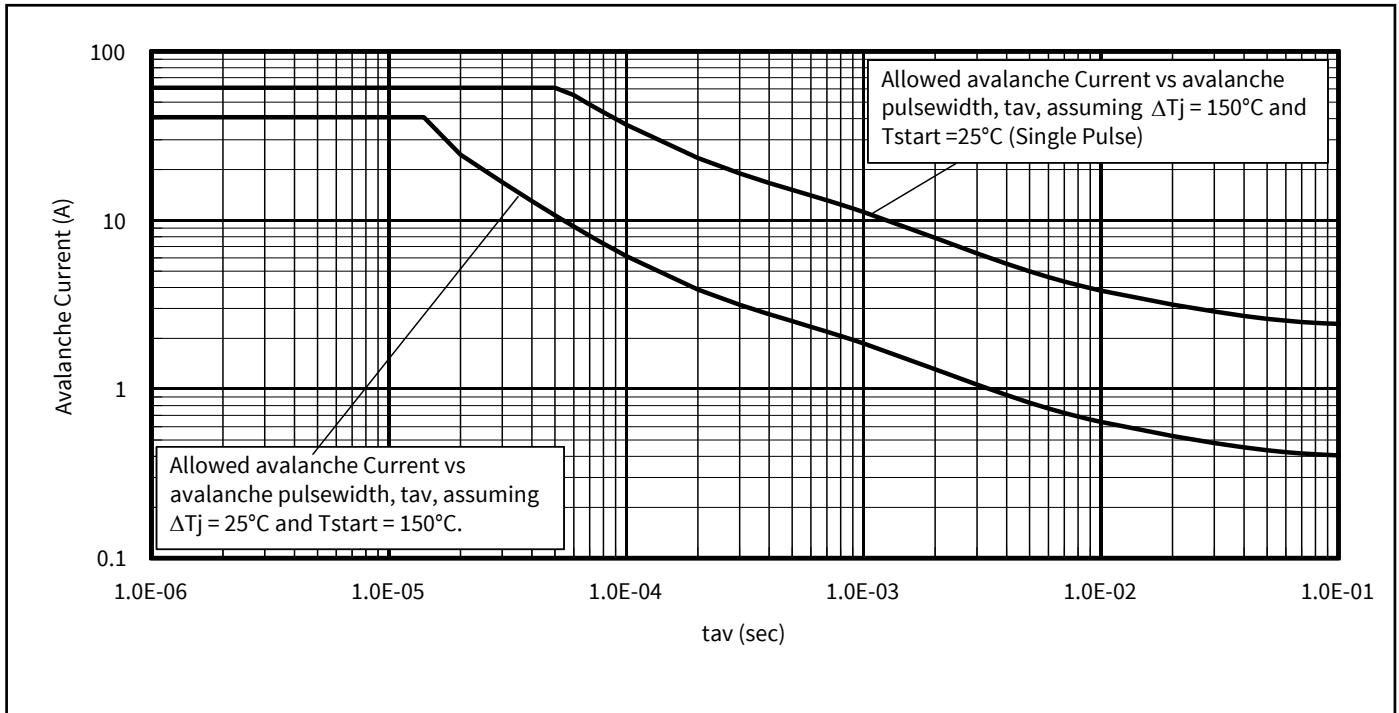
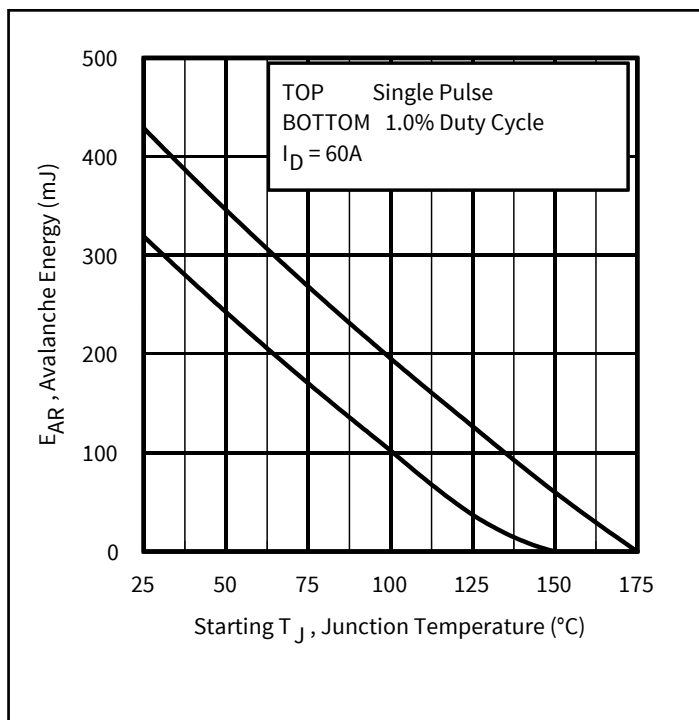

Figure 16 Avalanche Current vs. Pulse Width



**Notes on Repetitive Avalanche Curves , Figures 16, 17:  
(For further info, see AN-1005 at www.infineon.com)**

1. Avalanche failures assumption:  
Purely a thermal phenomenon and failure occurs at a temperature far in excess of  $T_{jmax}$ . This is validated for every part type.
2. Safe operation in Avalanche is allowed as long as  $T_{jmax}$  is not exceeded.
3. Equation below based on circuit and waveforms shown in Figures 23a, 23b.
4.  $P_{D(ave)}$  = Average power dissipation per single avalanche pulse.
5.  $BV$  = Rated breakdown voltage (1.3 factor accounts for voltage increase during avalanche).
6.  $I_{av}$  = Allowable avalanche current.
7.  $DT$  = Allowable rise in junction temperature, not to exceed  $T_{jmax}$  (assumed as 25°C in Figure 15, 16).

$t_{av}$  = Average time in avalanche.

$D$  = Duty cycle in avalanche =  $t_{av} \cdot f$

$Z_{thJC}(D, t_{av})$  = Transient thermal resistance, see Figures 14)

$$PD(ave) = 1/2 ( 1.3 \cdot BV \cdot I_{av} ) = \Delta T / Z_{thJC}$$

$$I_{av} = 2\Delta T / [1.3 \cdot BV \cdot Z_{th}]$$

$$E_{AS(AR)} = P_{D(ave)} \cdot t_{av}$$

Figure 17 Maximum Avalanche Energy vs. Temperature

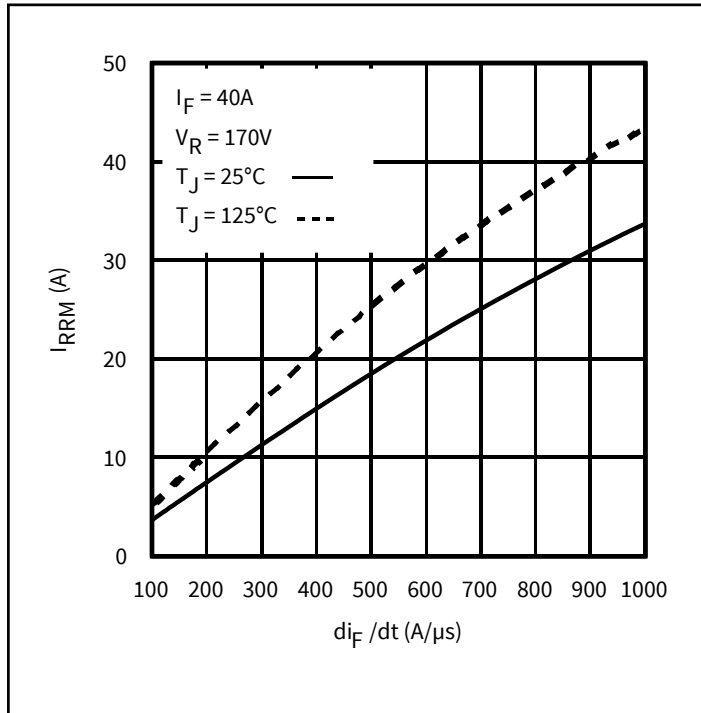

Figure 18 Typical Recovery Current vs.  $di_F/dt$

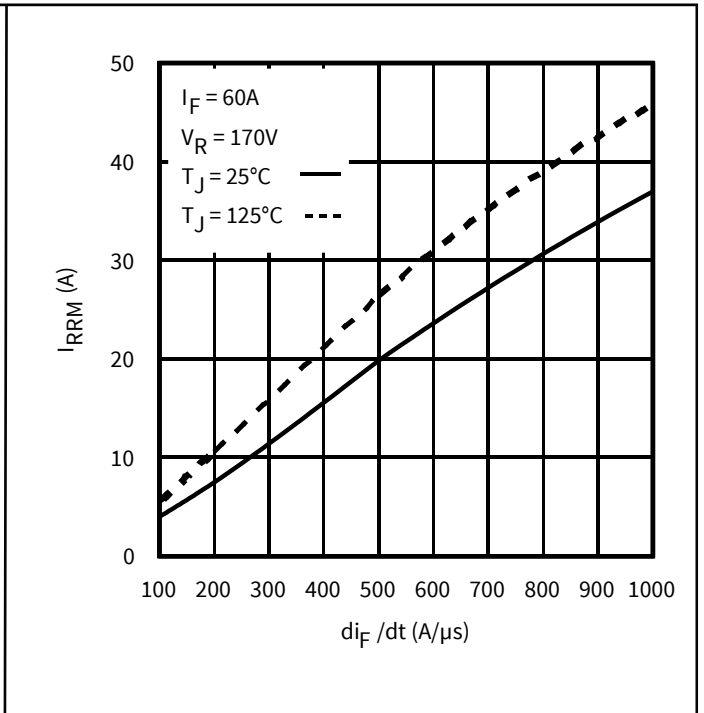

Figure 19 Typical Recovery Current vs.  $di_F/dt$

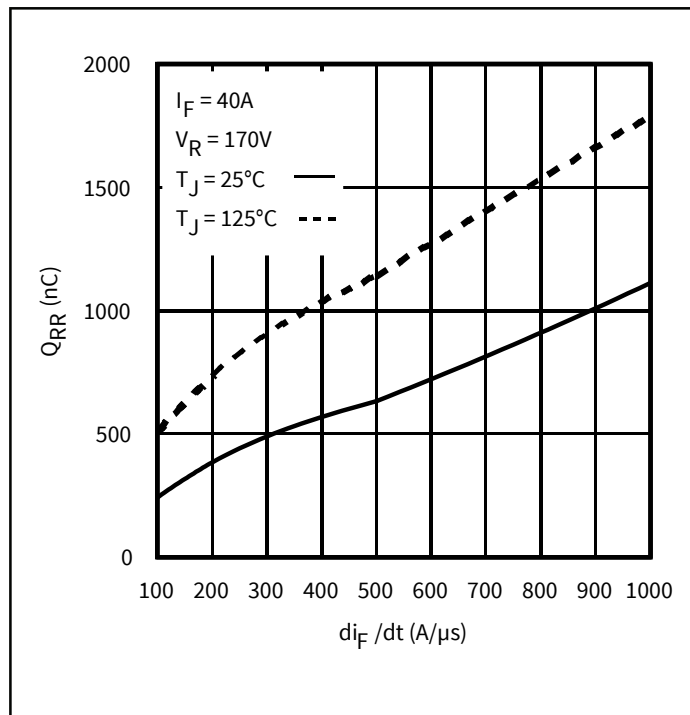

Figure 20 Typical Stored Charge vs.  $di_F/dt$

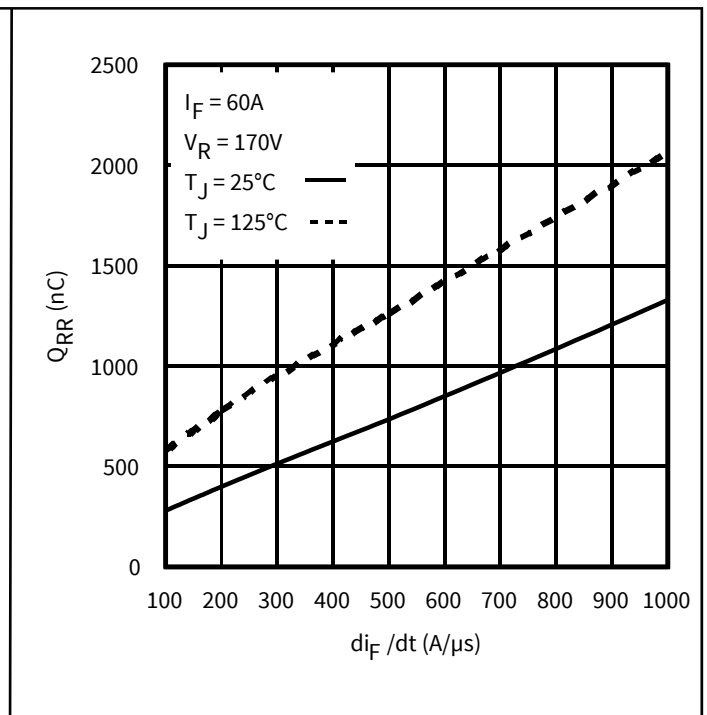

Figure 21 Typical Stored Charge vs.  $di_F/dt$

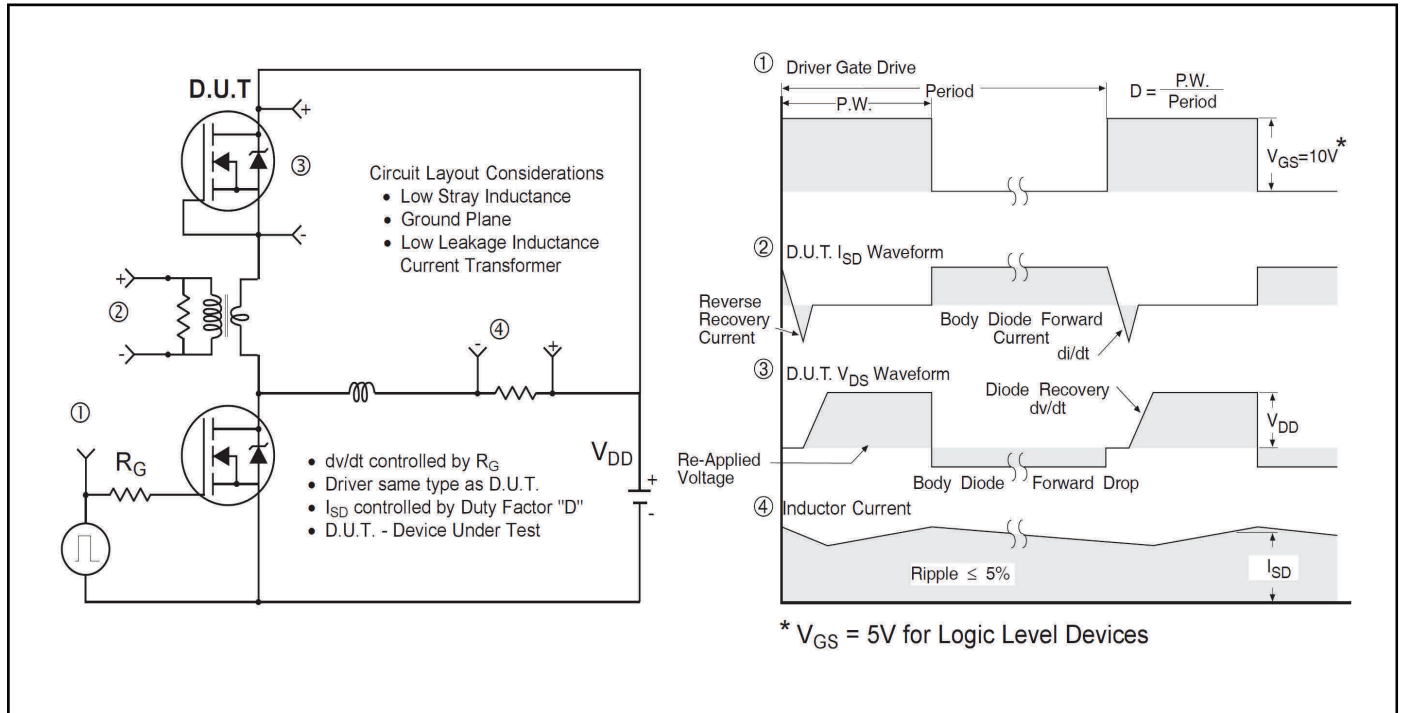

Figure 22 Peak Diode Recovery dv/dt Test Circuit for N-Channel HEXFET™ Power MOSFETs

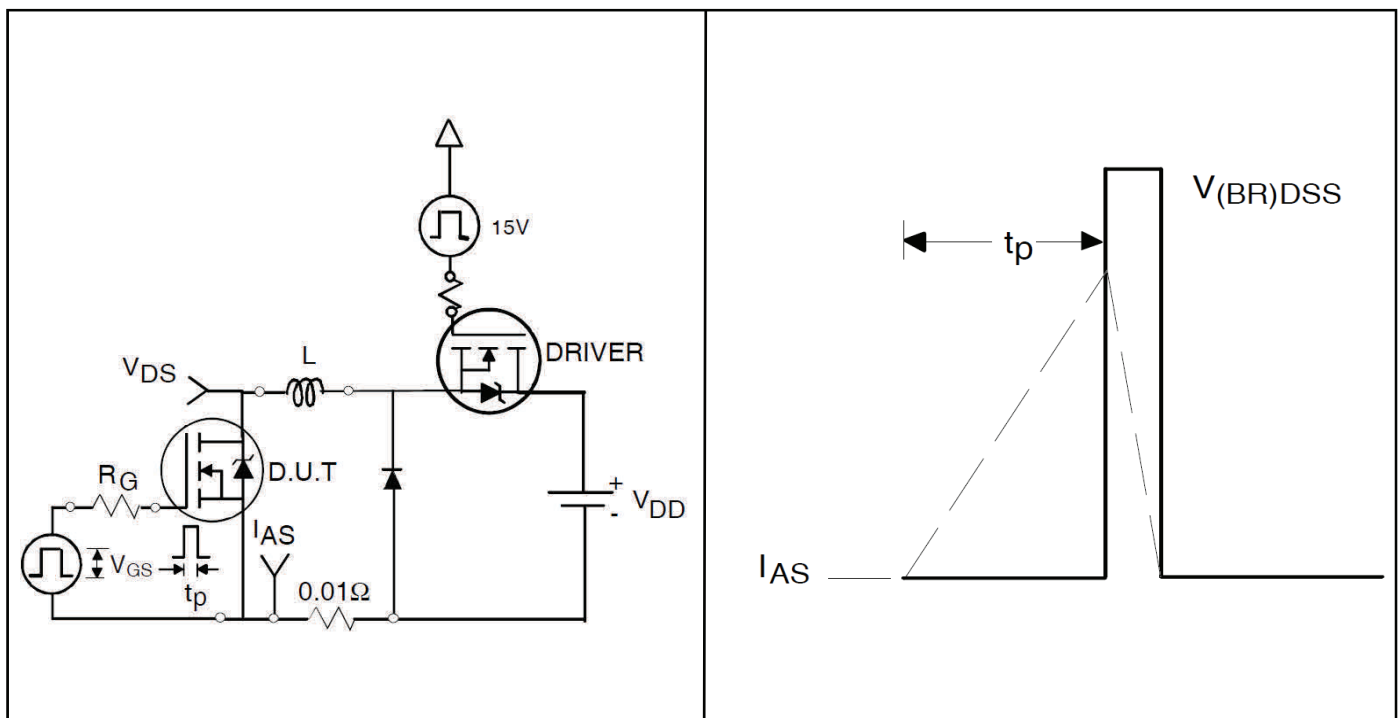

Figure 23a Unclamped Inductive Test Circuit

Figure 23b Unclamped Inductive Waveforms

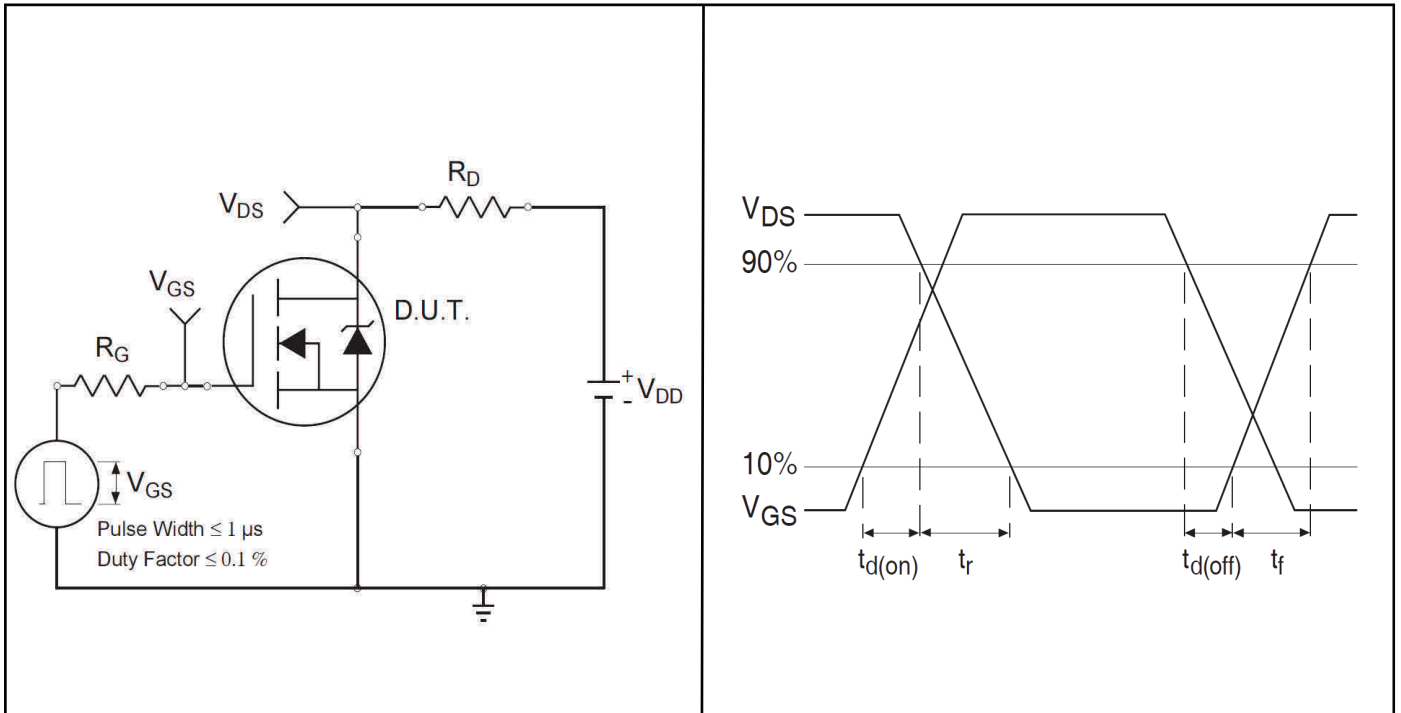
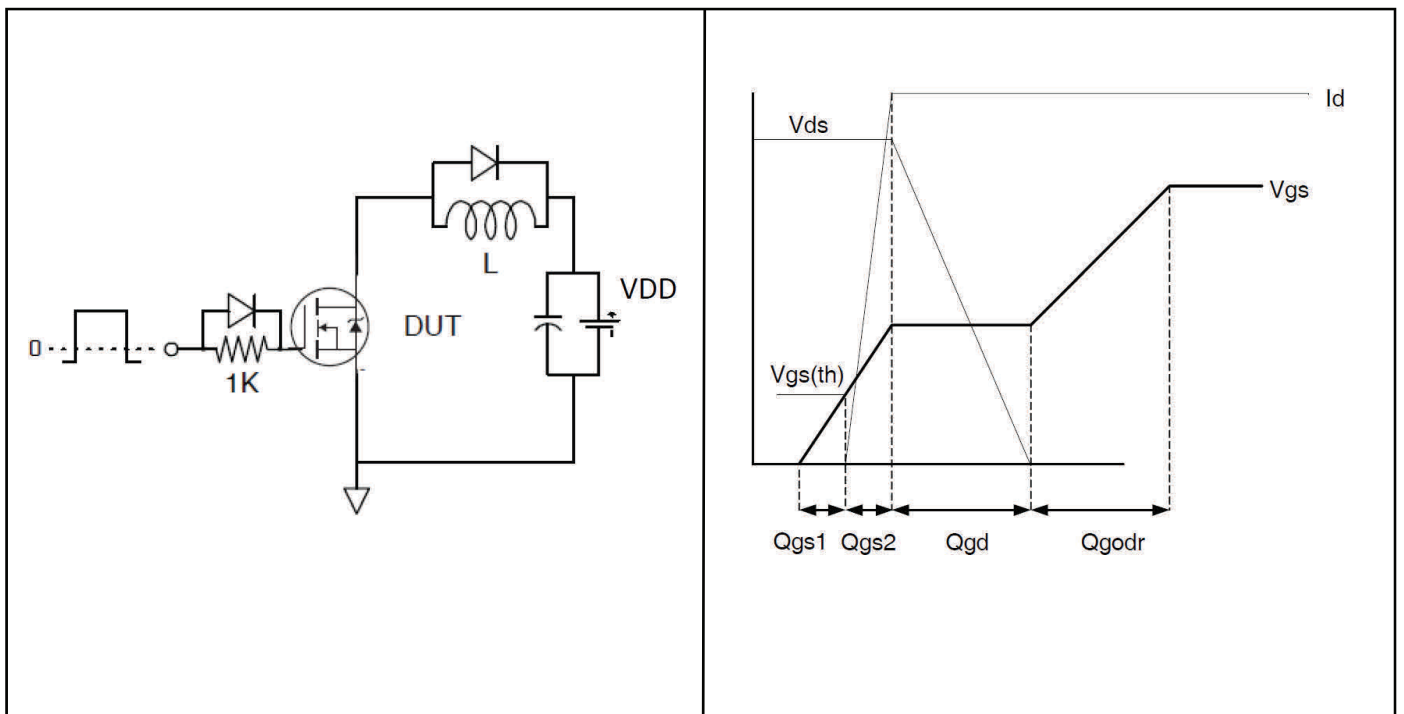

Figure 24a Switching Time Test Circuit

Figure 24b Switching Time Waveforms



## 5 Package Information

### TO-247AC Package Outline (Dimensions are shown in millimeters (inches))

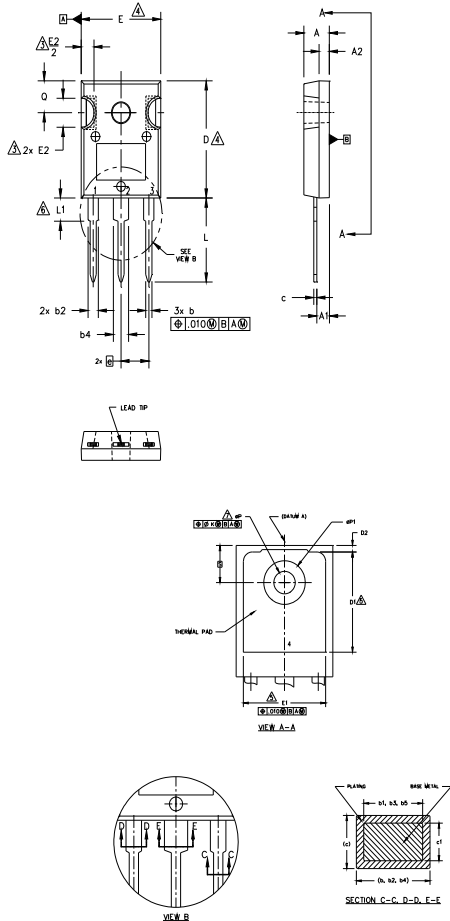

NOTES:

1. DIMENSIONING AND TOLERANCING AS PER ASME Y14.5M 1994.
2. DIMENSIONS ARE SHOWN IN INCHES.
3. CONTOUR OF SLOT OPTIONAL.
4. DIMENSION D & E DO NOT INCLUDE MOLD FLASH. MOLD FLASH SHALL NOT EXCEED .005" (0.127) PER SIDE. THESE DIMENSIONS ARE MEASURED AT THE OUTERMOST EXTREMES OF THE PLASTIC BODY.
5. THERMAL PAD CONTOUR OPTIONAL WITHIN DIMENSIONS D1 & E1.
6. LEAD FINISH UNCONTROLLED IN L1.
7.  $\phi P$  TO HAVE A MAXIMUM DRAFT ANGLE OF 1.5° TO THE TOP OF THE PART WITH A MAXIMUM HOLE DIAMETER OF .154 INCH.
8. OUTLINE CONFORMS TO JEDEC OUTLINE TO-247AC .

SYMBOL	DIMENSIONS				NOTES
	INCHES		MILLIMETERS		
	MIN.	MAX.	MIN.	MAX.	
A	.183	.209	4.65	5.31	
A1	.087	.102	2.21	2.59	
A2	.059	.098	1.50	2.49	
b	.039	.055	0.99	1.40	
b1	.039	.053	0.99	1.35	
b2	.065	.094	1.65	2.39	
b3	.065	.092	1.65	2.34	
b4	.102	.135	2.59	3.43	
b5	.102	.133	2.59	3.38	
c	.015	.035	0.38	0.89	
c1	.015	.033	0.38	0.84	
D	.776	.815	19.71	20.70	4
D1	.515	-	13.08	-	5
D2	.020	.053	0.51	1.35	
E	.602	.625	15.29	15.87	4
E1	.530	-	13.46	-	
E2	.178	.216	4.52	5.49	
e	.215 BSC		5.46 BSC		
$\phi k$	.010		0.25		
L	.559	.634	14.20	16.10	
L1	.146	.169	3.71	4.29	
$\phi P$	.140	.144	3.56	3.66	
$\phi P1$	-	.291	-	7.39	
Q	.209	.224	5.31	5.69	
S	.217 BSC		5.51 BSC		

LEAD ASSIGNMENTS

HEXFET

- 1.- GATE
- 2.- DRAIN
- 3.- SOURCE
- 4.- DRAIN

IGBTs, CoPACK

- 1.- GATE
- 2.- COLLECTOR
- 3.- EMITTER
- 4.- COLLECTOR

DIODES

- 1.- ANODE/OPEN
- 2.- CATHODE
- 3.- ANODE

### TO-247AC Part Marking Information

EXAMPLE: THIS IS AN IRFPE30  
WITH ASSEMBLY  
LOT CODE 5657  
ASSEMBLED ON WW 35, 2001  
IN THE ASSEMBLY LINE "H"

Note: "P" in assembly line position  
indicates "Lead-Free"

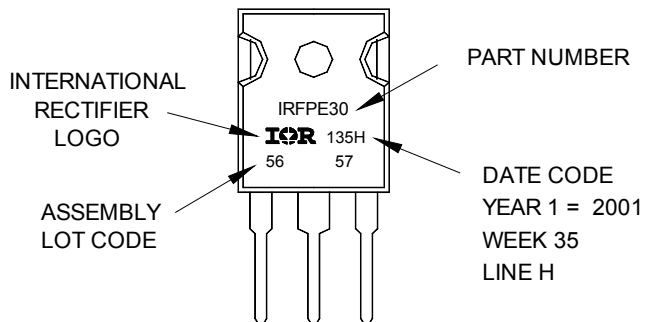

TO-247AC package is not recommended for Surface Mount Application.

## 6 Qualification Information

### Qualification Information

<b>Qualification Level</b>	Industrial (per JEDEC JESD47F) †	
<b>Moisture Sensitivity Level</b>	TO-247AC	N/A
<b>RoHS Compliant</b>	Yes	

† Applicable version of JEDEC standard at the time of product release.

## Revision History

### Major changes since the last revision

Page or Reference	Revision	Date	Description of changes
All pages	2.0	2017-03-16	<ul style="list-style-type: none"><li>• First release data sheet.</li></ul>
All pages	2.1	2020-01-07	<ul style="list-style-type: none"><li>• Update from “IR MOSFT/StrongIRFET™” to “StrongIRFET™” -all pages</li><li>• Update Package picture –page1</li></ul>



## Trademarks of Infineon Technologies AG

µHVIC™, µIPM™, µPFC™, AU-ConvertIR™, AURIX™, C166™, CanPAK™, CIPOST™, CIPURSE™, CoolDP™, CoolGaN™, COOLiR™, CoolMOS™, CoolSET™, CoolSiC™, DAVE™, DI-POL™, DirectFET™, DrBlade™, EasyPIM™, EconoBRIDGE™, EconoDUAL™, EconoPACK™, EconoPIM™, EiceDRIVER™, eupec™, FCOS™, GaNpowIR™, HEXFET™, HITFET™, HybridPACK™, iMOTION™, IRAM™, ISOFACE™, IsoPACK™, LEDrivIR™, LITIX™, MIPAQ™, ModSTACK™, my-d™, NovalithIC™, OPTIGA™, OptiMOS™, ORIGA™, PowIRaudio™, PowIRstage™, PrimePACK™, PrimeSTACK™, PROFET™, PRO-SIL™, RASIC™, REAL3™, SmartLEWIS™, SOLID FLASH™, SPOC™, StrongIRFET™, SupIRBuck™, TEMPFET™, TRENCHSTOP™, TriCore™, UHVIC™, XHP™, XMC™

Trademarks updated November 2015

## Other Trademarks

All referenced product or service names and trademarks are the property of their respective owners.

## IMPORTANT NOTICE

**Edition 2015-05-06**  
**Published by**  
**Infineon Technologies AG**  
**81726 Munich, Germany**

**© 2016 Infineon Technologies AG.**  
**All Rights Reserved.**

**Do you have a question about this document?**

**Email: [erratum@infineon.com](mailto:erratum@infineon.com)**

## Document reference

The information given in this document shall in no event be regarded as a guarantee of conditions or characteristics ("Beschaffenheitsgarantie").

With respect to any examples, hints or any typical values stated herein and/or any information regarding the application of the product, Infineon Technologies hereby disclaims any and all warranties and liabilities of any kind, including without limitation warranties of non-infringement of intellectual property rights of any third party.

In addition, any information given in this document is subject to customer's compliance with its obligations stated in this document and any applicable legal requirements, norms and standards concerning customer's products and any use of the product of Infineon Technologies in customer's applications.

The data contained in this document is exclusively intended for technically trained staff. It is the responsibility of customer's technical departments to evaluate the suitability of the product for the intended application and the completeness of the product information given in this document with

For further information on the product, technology, delivery terms and conditions and prices please contact your nearest Infineon Technologies office ([www.infineon.com](http://www.infineon.com)).

## WARNINGS

Due to technical requirements products may contain dangerous substances. For information on the types in question please contact your nearest Infineon Technologies office.

Except as otherwise explicitly approved by Infineon Technologies in a written document signed by authorized representatives of Infineon Technologies, Infineon Technologies' products may not be used in any applications where a failure of the product or any consequences of the use thereof can reasonably be expected to result in personal injury.