

- Designed small, 2- and 3-pole types break 5 A loads and 4-pole type, 3 A load
- High reliability, long life
- Ultra-high sensitivity with quick response
- High vibration/shock resistance
- 3- and 4-pole types have an arc barrier
- UL and CSA approved
- Withstands dielectric strength of 2,000 V
- Relays with high-capacity, LED indicator, diode surge suppression, push-to-test button, or RC circuit are available
- Changes due to aging are negligible because of use of special magnetic materials, thus ensuring long continuous holding time
- Little change in characteristics such as contact follow, contact pressure, etc., throughout long life



Ordering Information

To Order: Select the part number and add the desired coil voltage rating (e.g., MY4-DC6).

| Type | Terminal | Contact form | Construction | Part number | | | | | | |
|----------|----------------|--------------|--------------|---------------------------|------------------------|------------------------|---------------------------|------------------------|------------------------|---|
| | | | | Single contact | | | Bifurcated contact | | | |
| | | | | Standard bracket mounting | Upper mounting bracket | Lower mounting bracket | Standard bracket mounting | Upper mounting bracket | Lower mounting bracket | |
| Standard | Plug-in/solder | DPDT | Unsealed | MY2 | MY2F | MY2S | MY2Z | MY2ZF | MY2ZS | |
| | | | | MY3 | MY3F | MY3S | — | — | — | |
| | | | | MY4 | MY4F | MY4S | MY4Z | MY4ZF | MY4ZS | |
| | | PCB | | MY2-02 | — | — | MY2Z-02 | — | — | |
| | | | | MY3-02 | — | — | — | — | — | |
| | | | | MY4-02 | — | — | MY2Z-02 | — | — | |
| | Plug-in/solder | 4PDT | Sealed | MYQ4 | — | — | MYQ4Z | — | — | |
| | | | | MYQ4-02 | — | — | MYQ4Z-02 | — | — | |
| | PCB | 4PDT | | MY4H | — | — | MY4ZH | — | — | |
| | | | | MY4H-0 | — | — | MY4ZH-0 | — | — | |
| | Plug-in/solder | 4PDT | | Hermetically Sealed | MY4H | — | — | MY4ZH | — | — |
| | | | | | MY4H-0 | — | — | MY4ZH-0 | — | — |

- Note: 1. For SEV approved type, order the following: MY4-SV-DC6. (Lloyd's Register approval. See "Approvals" section.)
 2. To order connecting sockets and mounting tracks, see "Accessories" section.
 3. AgCdO contacts are also available (MY2E, MY3E, MY4E). Contact your OMRON sales representative for details.

Ordering information (continued)

| Type | Terminal | Contact form | Construction | Part number | | | | | |
|--|----------------|--------------|-------------------|---------------------------|------------------------|------------------------|---------------------------|------------------------|------------------------|
| | | | | Single contact | | | Bifurcated contact | | |
| | | | | Standard bracket mounting | Upper mounting bracket | Lower mounting bracket | Standard bracket mounting | Upper mounting bracket | Lower mounting bracket |
| LED indicator | Plug-in/solder | DPDT | | MY2N | — | — | MY2ZN | — | — |
| | | 3PDT | | MY3N | — | — | — | — | — |
| | | 4PDT | | MY4N | — | — | MY4ZN | — | — |
| High-capacity | | DPDT | w/o LED indicator | MY2-Y | — | — | — | — | — |
| | | | LED indicator | MY2N-Y | — | — | — | — | — |
| Diode surge suppression* | | DPDT | | MY2-D | — | — | MY2Z-D | — | — |
| | | 3PDT | | MY3-D | — | — | — | — | — |
| | | 4PDT | | MY4-D | — | — | MY4Z-D | — | — |
| LED indicator and diode surge suppression* | | DPDT | | MY2N-D2 | — | — | MY2ZN-D2 | — | — |
| | | 3PDT | | MY3N-D2 | — | — | — | — | — |
| | | 4PDT | | MY4N-D2 | — | — | MY4ZN-D2 | — | — |
| RC circuit** | | DPDT | w/o LED indicator | MY2-CR | — | — | MY2Z-CR | — | — |
| | | | | MY3-CR | — | — | — | — | — |
| | | | | MY4-CR | — | — | MY4Z-CR | — | — |
| | | 4PDT | LED indicator | MY2N-CR | — | — | — | — | — |
| | | | | MY4N-CR | — | — | — | — | — |
| | | | | | | | | | |
| Push-to-test button | | DPDT | | MY214 | — | — | MY2Z12 | — | — |
| | | 4PDT | | MY414 | — | — | MY4Z12 | — | — |
| LED indicator and RC circuit | | DPDT | | MY214N | — | — | MY2Z12N | — | — |
| | | 4PDT | | MY414N | — | — | MY4Z12N | — | — |

| Type | Terminal | Contact form | Part number |
|----------|---------------------|--------------|-------------------|
| Latching | Plug-in PC board | DPDT | MY2K-US |
| | | | MY2K-02-US |

- Note: 1. For SEV approved type, order as the following: MY4-SV-DC6. (Lloyd's Register approval. See "Approvals" section.)
 2. To order connecting sockets and mounting tracks, see "Accessories" section.
 3. AgCdO contacts are also available. Contact your OMRON sales representative for details.
 4. * DC coils only
 ** AC coils only

■ ACCESSORIES

Connecting Sockets

To Order: Select the appropriate part numbers for sockets, clips, and mounting tracks (if required) from the available types chart.

Available Types

Track mounted sockets

| Relay | Socket* | Relay hold-down clip | | Mounting track |
|-------|-----------------|----------------------|---------------|--|
| | | Standard | RC circuit | |
| DPDT | PYF08A-E | PYC-A1 | Y92-H3 | PFP-100N/PFP-50N & PFP-M or PFP-100N2 PFP-S (Optional spacer) |
| 3PDT | PYF11A | | | |
| 4PDT | PYF14A-E | | | |

* Track mounted socket can be used as a front connecting socket.

Back connecting sockets

| Relay | Solder terminal socket | Wire wrap terminal socket | Relay hold-down clip | | | | Socket Mounting Plate | | |
|-------|------------------------|---------------------------|----------------------|---------------|--------------|--------------|-----------------------|---------------|---------------|
| | | | Standard | Push-to-test | RC circuit | Mtg. plate | 1 | 18 | 36 |
| DPDT | PY08 | PY08QN | PYC-P | PYC-P2 | PYC-1 | PYC-S | PYP-1 | PYP-18 | PYP-36 |
| 3PDT | PY11 | PY11QN | | | | | | | |
| 4PDT | PY14 | PY14QN | | | | | | | |

Note: Types PYP-18, PTP-12 and PTP-10 may be cut to any desired length.

| Relay | PC terminal socket | Relay hold-down clip | | |
|-------|--------------------|----------------------|---------------|--------------|
| | | Standard | Push-to-test | RC circuit |
| DPDT | PY08-02 | PYC-P | PYC-P2 | PYC-1 |
| 3PDT | PY11-02 | | | |
| 4PDT | PY14-02 | | | |

Specifications

■ **CONTACT DATA**

Non-latching – Unsealed

| Load | DPDT, 3PDT | | 4DPT | | High-capacity | |
|----------------------------------|--|--|--|--|---------------------------|--|
| | Resistive load (p.f. = 1) | Inductive load (p.f. = 0.4) (L/R = 7 ms) | Resistive load (p.f. = 1) | Inductive load (p.f. = 0.4) (L/R = 7 ms) | Resistive load (p.f. = 1) | Inductive load (p.f. = 0.4) (L/R = 7 ms) |
| Rated load | 5 A at 220 VAC 5 A at 24 VDC | 2 A at 220 VAC 2 A at 24 VDC | 3 A at 220 VAC 3 A at 24 VDC | 0.8 A at 220 VAC 1.5 A at 24 VDC | 7 A 220 VAC 7 A 24 VDC | 3.5 A 220 VAC 3.5 A 24 VDC |
| Contact material | Ag | | Ag (Au Flash) | | AgCdO | |
| Carry current | 5 A | 3 A | 1 A | 3 A | 7 A | |
| Max. operating voltage | 250 VAC 125 VDC | | | | | |
| Max. operating current | 5 A | | 1 A | 3 A | 7 A | |
| Max. switching capacity | 1,100 VA 120 W | 440 VA 48 W | 660 VA 72 W | 176 VA 36 W | 1,540 VA 168 W | 770 VA 84 W |
| Min. permissible load (see note) | Standard type: 1 mA, 5 VDC Bifurcated type: 100 μA, 1 VDC | | Standard and high sensitivity types: 1 mA, 1 VDC | | 100 μA, 1 VDC | |

Non-latching – Sealed/Hermetically sealed

| Load | Sealed, 4PDT | | Hermetically sealed, 4DPT | |
|----------------------------------|--|--|---------------------------------|--|
| | Resistive load (p.f. = 1) | Inductive load (p.f. = 0.4) (L/R = 7 ms) | Resistive load (p.f. = 1) | Inductive load (p.f. = 0.4) (L/R = 7 ms) |
| Rated load | 1 A at 220 VAC 1 A at 24 VDC | 0.5 A at 220 VAC 0.5 A at 24 VDC | 3 A at 110 VAC 3 A at 24 VDC | 0.8 A at 110 VAC 1.5 A at 24 VDC |
| Contact material | Ag (Au Flash) | | | |
| Carry current | 1 A | | 3 A | |
| Max. operating voltage | 250 VAC 125 VDC | | 125 VAC 125 VDC | |
| Max. operating current | 1 A | | 3 A | |
| Max. switching capacity | 220 VA 24 W | 110 VA 12 W | 330 VA 72 W | 88 VA 36 W |
| Min. permissible load (see note) | Standard and high sensitivity types: 1 mA, 1 VDC Bifurcated type: 100 μA, 1 VDC | | | |

Note: P level: λ60 = 0.1 x 10⁻⁶/operation

■ COIL DATA

Non-latching – AC

| Rated voltage (V) | Rated current (mA) | | Coil resistance (Ω) | Coil inductance (ref. value) (H) | | Pick-up voltage (% of rated voltage) | Dropout voltage | Maximum voltage | Power consumption (VA, W) |
|-------------------|--------------------|-----------|---------------------|----------------------------------|-------------|--------------------------------------|-----------------|-----------------|---------------------------|
| | 50 Hz | 60 Hz | | Armature OFF | Armature ON | | | | |
| 6 | 214.10 | 183 | 12.20 | 0.04 | 0.08 | 80% max. | 30% min. | 110% max. | Approx. 1.00 to 1.20 |
| 12 | 106.50 | 91 | 46 | 0.17 | 0.33 | | | | |
| 24 | 53.80 | 46 | 180 | 0.69 | 1.30 | | | | |
| 50 | 25.70 | 22 | 788 | 3.22 | 5.66 | | | | |
| 100/110 | 11.70/12.90 | 10/11 | 3,750 | 14.54 | 24.60 | | | | Approx. 0.90 to 1.10 |
| 110/120 | 9.90/10.80 | 8.40/9.20 | 4,430 | 19.20 | 32.10 | | | | |
| 200/220 | 6.20/6.80 | 5.30/5.80 | 12,950 | 54.75 | 94.07 | | | | |
| 220/240 | 4.80/5.30 | 4.20/4.60 | 18,790 | 83.50 | 136.40 | | | | |

Non-latching – DC

| Rated voltage (V) | Rated current (mA) | Coil resistance (Ω) | Coil inductance (ref. value) (H) | | Pick-up voltage (% of rated voltage) | Dropout voltage | Maximum voltage | Power consumption (VA, W) |
|-------------------|--------------------|---------------------|----------------------------------|-------------|--------------------------------------|-----------------|-----------------|---------------------------|
| | | | Armature OFF | Armature ON | | | | |
| 6 | 150 | 40 | 0.17 | 0.33 | 80% max. | 10% min. | 110% max. | Approx. 0.90 |
| 12 | 75 | 160 | 0.73 | 1.37 | | | | |
| 24 | 36.90 | 650 | 3.20 | 5.72 | | | | |
| 48 | 18.50 | 2,600 | 10.60 | 21.00 | | | | |
| 100/110 | 9.10/10 | 11,000 | 45.60 | 86.20 | | | | |

Latching – AC

| Rated voltage (V) | Rated current (mA) | | | Coil resistance (Ω) | | Pick-up voltage (% of rated voltage) | Dropout voltage | Maximum voltage | Power consumption (VA, W) | |
|-------------------|--------------------|-------|------------|---------------------|------------|--------------------------------------|-----------------|-----------------|---------------------------|-------------------------|
| | Set coil | | Reset coil | Set coil | Reset coil | | | | Set coil | Reset coil |
| | 50 Hz | 60 Hz | 50/60 Hz | | | | | | | |
| 6 | 146 | 142 | 68 | 13 | 32 | 80% max. | 80% max. | 110% max. | Approx. 0.60 to 0.90 | Approx. 0.20 to 0.50 |
| 12 | 57 | 56 | 39 | 72 | 130 | | | | | |
| 24 | 27.40 | 26.40 | 18.60 | 320 | 550 | | | | | |
| 50 | 14 | 13.40 | 3.50 | 1,400 | 3,000 | | | | | |
| 120 | 15.80 | 5.60 | 3.50 | 8,300 | 3,000 | | | | | |

Latching – DC

| Rated voltage (V) | Rated current (mA) | | Coil resistance (Ω) | | Pick-up voltage (% of rated voltage) | Dropout voltage | Maximum voltage | Power consumption (VA, W) | |
|-------------------|--------------------|------------|---------------------|------------|--------------------------------------|-----------------|-----------------|---------------------------|-----------------|
| | Set coil | Reset coil | Set coil | Reset coil | | | | Set coil | Reset coil |
| | 50/60 Hz | 50/60 Hz | | | | | | | |
| 6 | 230 | 100 | 26 | 60 | 80% max. | 80% max. | 110% max. | Approx. 1.30 | Approx. 0.06 |
| 12 | 110 | 50 | 110 | 235 | | | | | |
| 24 | 52 | 25 | 470 | 940 | | | | | |

- Note:
1. The rated current and coil resistance are measured at a coil temperature of 23°C (73°F) with tolerances of +15%, -20% for AC rated current, and ±15% for DC rated coil resistance.
 2. The AC coil resistance and inductance are reference values at 60 Hz.
 3. The performance characteristics are measured at a coil temperature of 23°C (73°F).
 4. Because the coil is designed for low power consumption, connect a bleeder (if necessary after confirming the leakage current), when the coil is driven by an SCR.
 5. For AC type latching coils, the rated current values are half-wave rectified current values measured with a DC ammeter.

■ CHARACTERISTICS

Non-latching

| | | |
|-----------------------|-------------------------|---|
| Contact resistance | | 50 mΩ max. |
| Operate time | | 20 ms max. |
| Release time | | 20 ms max. |
| Operating frequency | Mechanically | 18,000 operations/hour |
| | Under rated load | 1,800 operations/hour |
| Insulation resistance | | 100 MΩ min. (at 500 VDC) |
| Dielectric strength | Single contact type | Unsealed: 2,000 VAC, 50/60 Hz for 1 minute 1,000 VAC, 50/60 Hz for 1 minute between contacts of same polarity Sealed: 1,500 VAC, 50/60 Hz for 1 minute 1,000 VAC, 50/60 Hz for 1 minute between contacts of same polarity Hermetically sealed: 1,000 VAC, 50/60 Hz for 1 minute 700 VAC, 50/60 Hz for 1 minute between contacts of same polarity |
| | Bifurcated contact type | 1,500 VAC, 50/60 Hz for 1 minute 1,000 VAC, 50/60 Hz for 1 minute between non-continuous contacts |
| Vibration | Mechanical durability | 10 to 55 Hz, 1.00 mm (0.04 in) double amplitude |
| | Malfunction durability | 10 to 55 Hz, 1.00 mm (0.04 in) double amplitude |
| Shock | Mechanical durability | 1,000 m/s ² (approx. 100 G) |
| | Malfunction durability | 200 m/s ² (approx. 20 G) |
| Ambient temperature | Operating | Unsealed: -55° to 70°C (-67° to 158°F) Sealed: -55° to 60°C (-67° to 140°F) Hermetically sealed: 25° to 60°C (77° to 140°F) |
| Humidity | | 35% to 85% RH |
| Service Life | Mechanically | Single contact type: AC: 50 million operations min. (at operating frequency of 18,000 operations/hour) DC: 100 million operations min. (at operating frequency of 18,000 operations/hour) |
| | Mechanically | Bifurcated contact type: AC: 50 million operations min. DC: 20 million operations min. (5 million operations for the sealed/hermetically sealed types) (at operating frequency of 1,800 operations/hour) |
| | Electrically | See "Characteristic Data" |
| Weight | | Sealed/unsealed: Approx. 35 g (1.23 oz) Hermetically sealed: Approx. 50 g (1.76 oz) |

Latching

| | | |
|-----------------------|------------------------|---|
| Contact resistance | | 50 mΩ max. |
| Operate time | | AC: 30 ms max.; DC: 15 ms max. |
| Release time | | AC: 30 ms max.; DC: 15 ms max. |
| Operating frequency | Mechanically | 18,000 operations/hour |
| | Under rated load | 1,800 operations/hour |
| Insulation resistance | | 100 MΩ min. (at 500 VDC) |
| Dielectric strength | | 1,500 VAC, 50/60 Hz for 1 minute 1,000 VAC, 50/60 Hz for 1 minute between contacts of same polarity, and between set and reset coils |
| Vibration | Mechanical durability | 10 to 55 Hz, 1.00 mm (0.04 in) double amplitude |
| | Malfunction durability | 10 to 55 Hz, 1.00 mm (0.04 in) double amplitude |
| Shock | Mechanical durability | 1,000 m/s ² (approx. 100 G) |
| | Malfunction durability | 200 m/s ² (approx. 20 G) |
| Ambient temperature | Operating | -55° to 70°C (-67° to 158°F) |
| Humidity | | 45% to 85% RH |
| Service Life | Mechanically | 100 million operations min. (at operating frequency of 18,000 operations/hour) |
| | Electrically | See "Characteristic Data" |
| Weight | | Approx. 30 g (1.06 oz) |

Note: Data shown are of initial value.

CHARACTERISTIC DATA

Maximum switching capacity – Non-latching

MY2, MY3



MY4

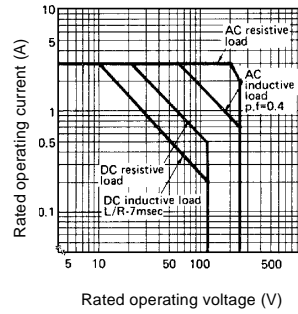

MY4(Z)H

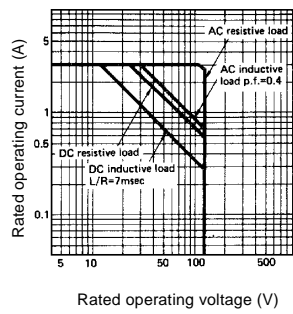

MYQ4(Z)H



Electrical service life

MY2, MY3 (Resistive load)

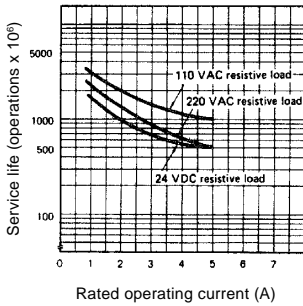

MY2, MY3 (Inductive load)

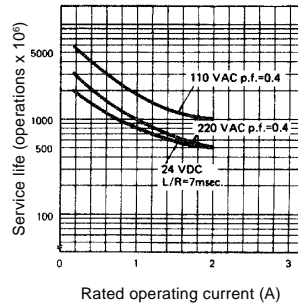

MY4 (Resistive load)

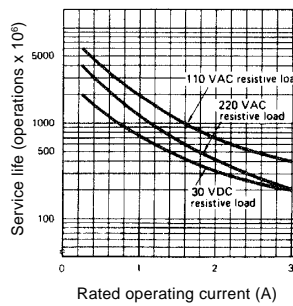

MY4 (Inductive load)

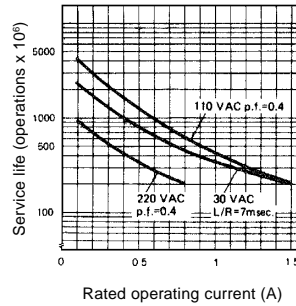

MY4H

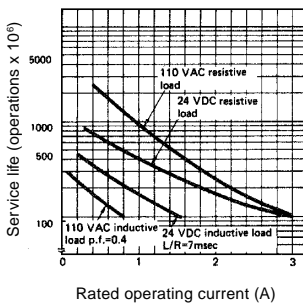

MY4Z (Resistive load)

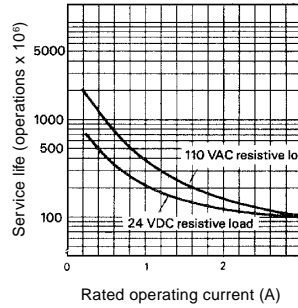

MY4Z (Inductive load)

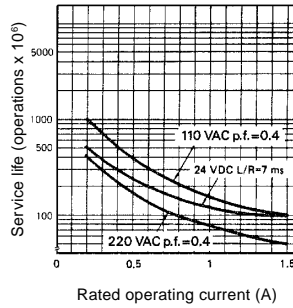

MYQ4

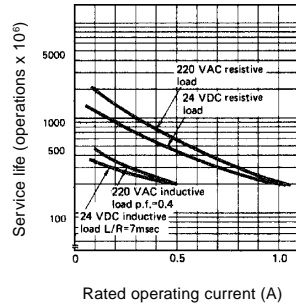

MY2-Y (Resistive load)

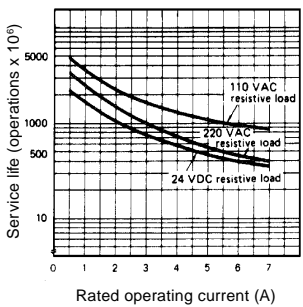

MY2-Y (Inductive load)

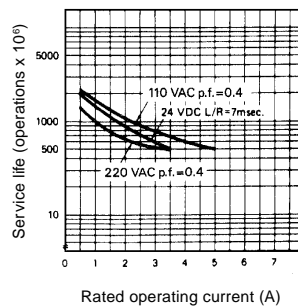

Maximum switching capacity – Latching

MY2K(-02)-US

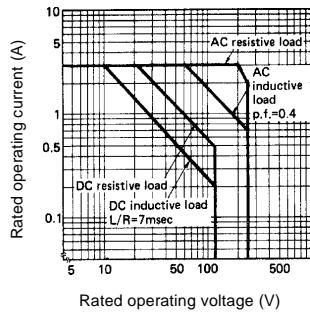

Electrical service life

MY2K(-02)-US

(Resistive load)

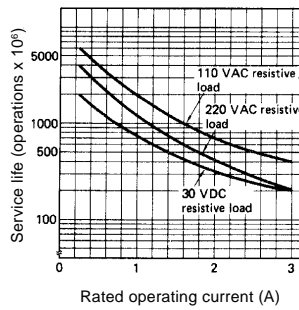

(Inductive load)

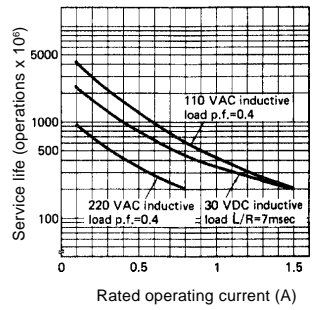

Dimensions

Unit: mm (inch)

RELAYS

MY2

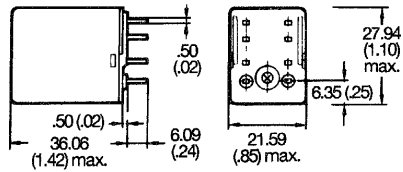
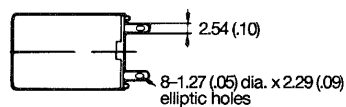

MY3

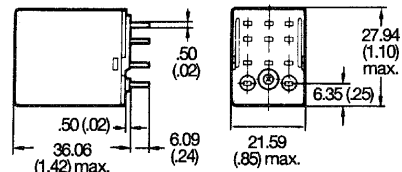
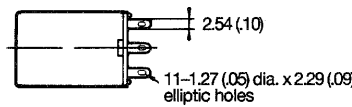

MY4

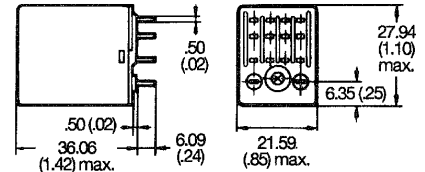
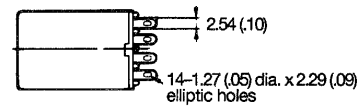

MY□-02

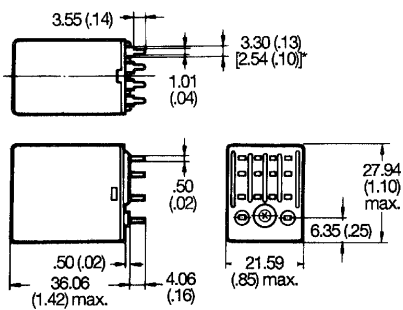

Mounting holes

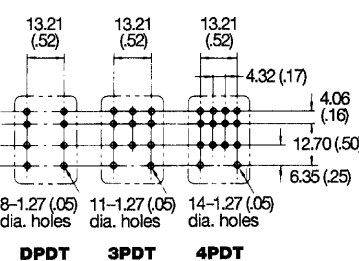

MY□F

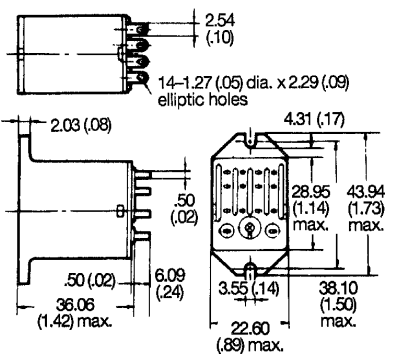

Mounting holes

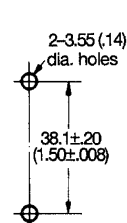

Note: The above dimensioned drawing shows the 4-pole type. The dimensions of the 2- and 3-pole types are identical to the 4-pole type.

Unit: mm (inch)

■ RELAYS (continued)

MY(Z)H



MY4(Z)H-0



MY□-5

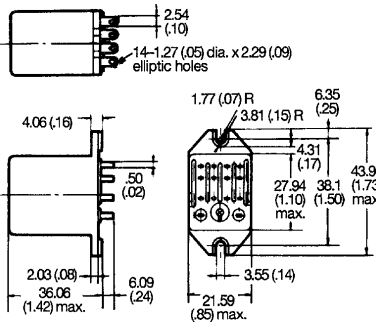

Mounting holes



Terminal arrangement

(Bottom view)

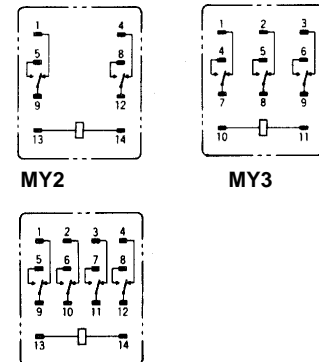

MY4, MYQ4(Z), MY4(Z)H, MY4H-0

Note: The above dimensioned drawing shows the 4-pole type. The dimensions of the 2- and 3-pole types are identical to the 4-pole type.

MYQ4(Z)

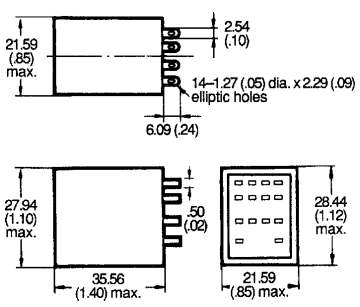

MYQ4(Z)-02

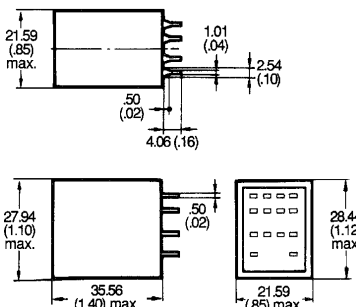

MY2K-US

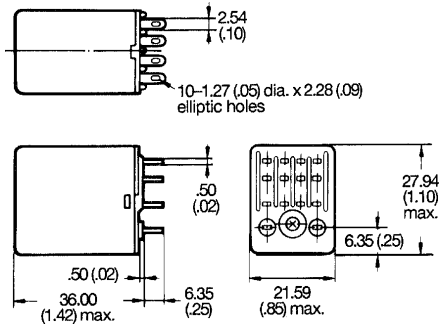

MY2K-02-US

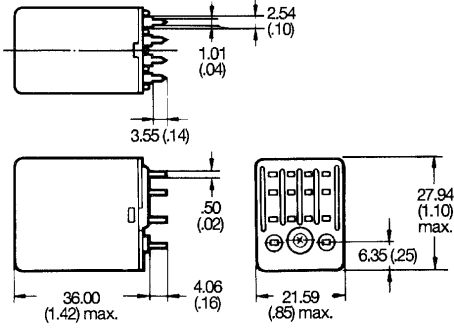

Mounting holes

(Bottom view)

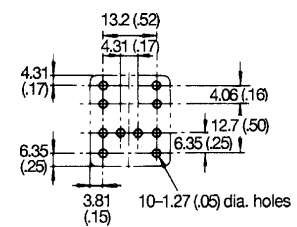

Unit: mm (inch)

■ ACCESSORIES

Track mounted sockets (UL File No. E87929) (CSA Report No. LR46088)

PYF08A-E

Terminal arrangement/
mounting holes
(Top view)

PYF11A

Terminal arrangement/
mounting holes
(Top view)

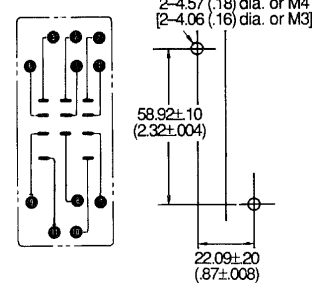
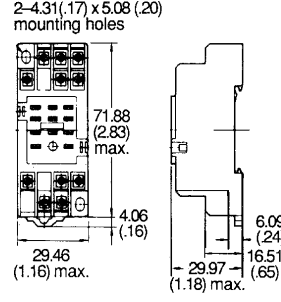
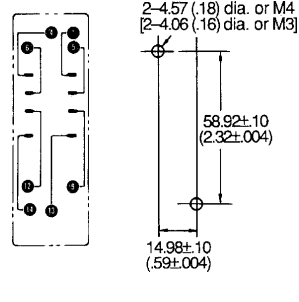
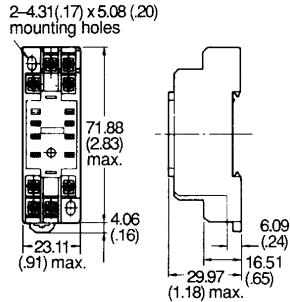

PYF14A-E

Terminal arrangement/
mounting holes
(Top view)

Mounting height of
relay with socket

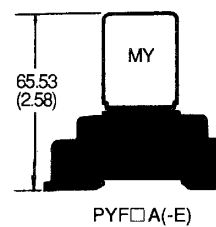
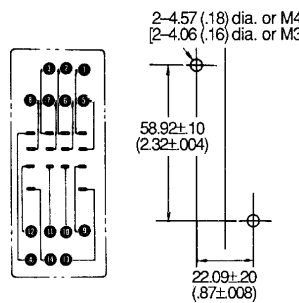
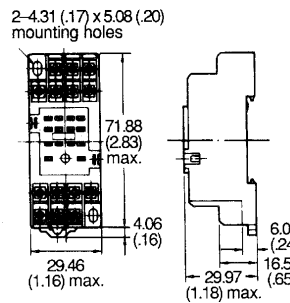

Back connecting socket (UL File No. E87929) (CSA Report No. LR46088) – DPDT

PY08

PY08QN

PY08-02

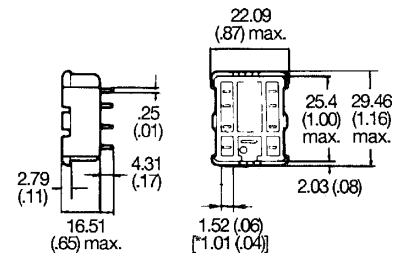
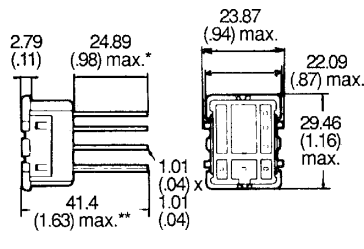
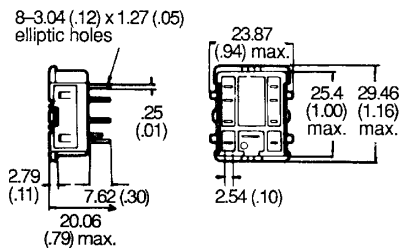

Back connecting socket (UL File No. E87929) (CSA Report No. LR46088) – 3PDT

PY11

PY11QN

PY11-02

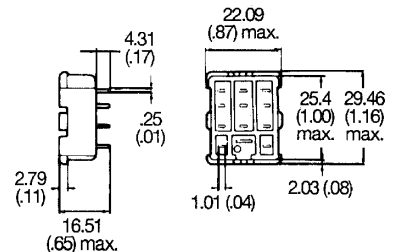
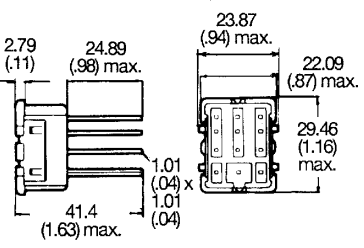
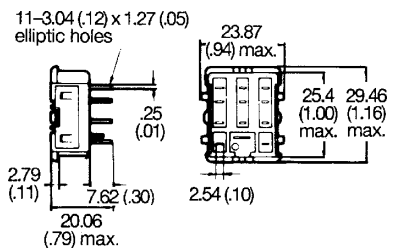

Note: 1. UL/CSA does not apply to wire wrap (Q) type sockets.
2. Value in brackets is for MY□CR.

Unit: mm (inch)

■ ACCESSORIES (continued)

Back connecting socket (UL File No. E87929) (CSA Report No. LR46088) – 4PDT

PY14

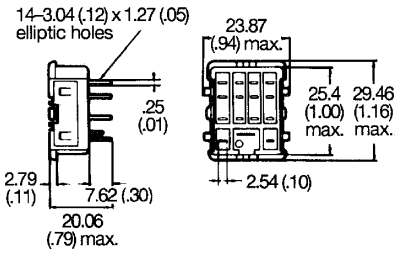

PY14QN



PY14-02

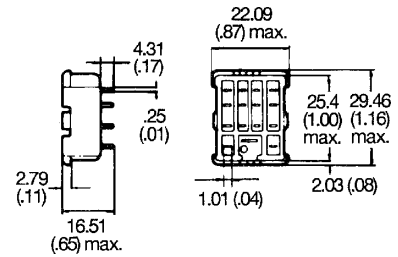

Terminal arrangement (Bottom view)

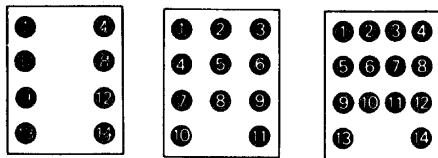

DPDT

3DPT

4DPT

Panel cutout

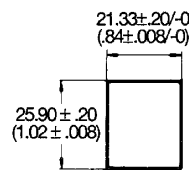

Mounting height of relay with socket

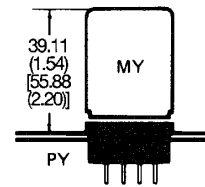

Note: Value in brackets is for MY□-CR.

Mounting holes

DPDT

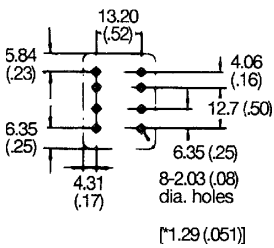

3PDT

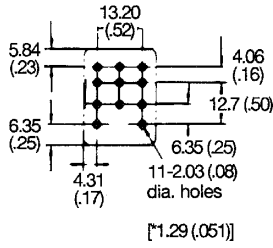

4PDT

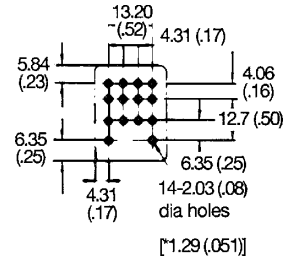

* For types with suffix - 02.

Relay hold-down clip

PYC-A1

for PYF□A socket

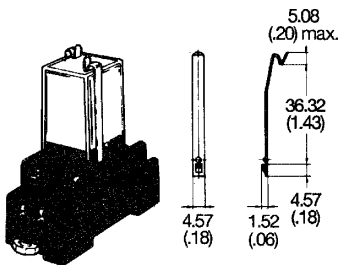

PYC-P

for PY□ socket

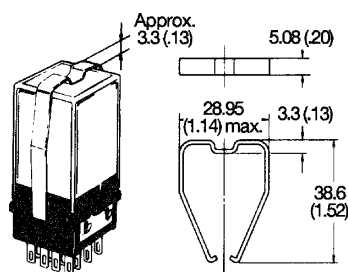

PYC-S

for relay mounting plates

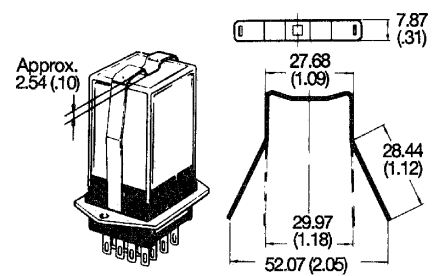

Relay hold-down clip

PYC-P2

for test button self-contained type with PY□A socket



Y92-HC

for RC circuit



PYC-1

for RC circuit



PFP-100N/PFP-50N mounting track

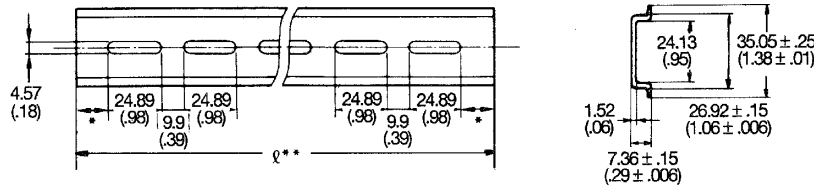

PFP-100N2 mounting track

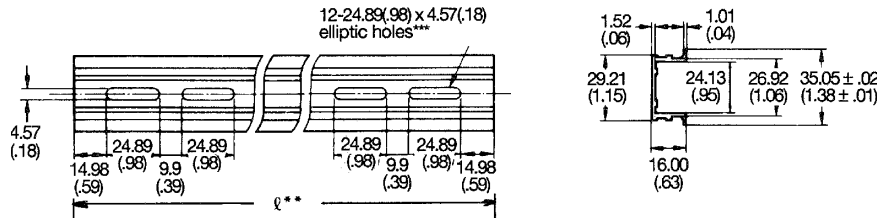

* This dimension is 14.99 mm (0.59 in) on both ends in the case of PFP-100N, but on one end in the case of PFP-50N.

** L = Length

PFP-50N L = 497.84 mm (19.60 in)

PFP-100N L = 990.60 mm (39.00 in)

PFP-100N2 L = 990.60 mm (39.00 in)

*** A total of twelve 24.89 x 4.57 mm (0.98 x 0.18 in) elliptical holes are provided, with six holes cut from each end of the track at a pitch of 9.91 (0.39) between holes.

PFP-M end plate

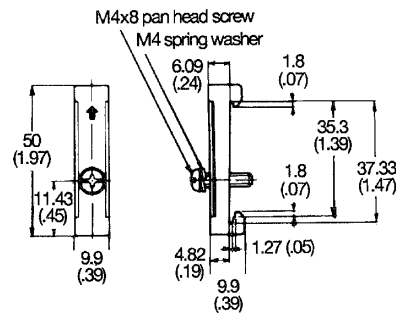

PFP-S spacer

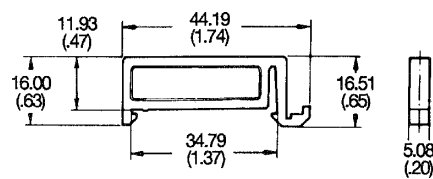

Unit: mm (inch)

■ **ACCESSORIES (continued)**

Socket mounting plates [t=1.52 (.06)]

PYP-1

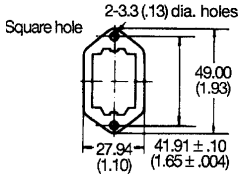

PYP-18

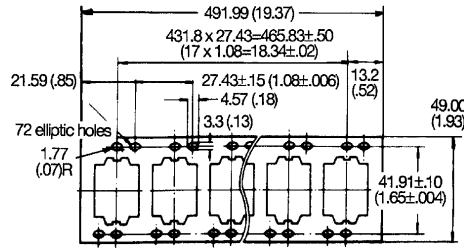

PYP-36

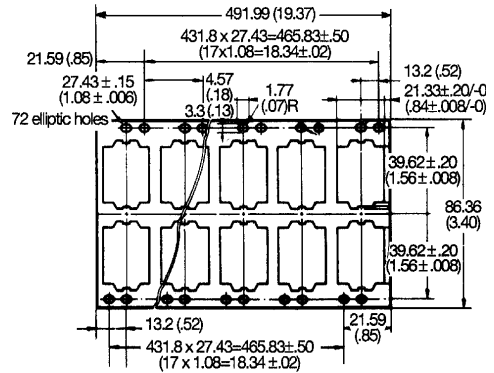

| | Number of socket specs. | | |
|---------------------------------|-------------------------|--------|--------|
| Socket needed | 1 | 18 | 36 |
| PY08, PY11, PY11QN, PY14, PY4QN | PYP-1 | PYP-18 | PYP-36 |

■ **RELAY OPTIONS**

LED Indicator

Specifications and dimensions same as the standard type with the following exception. Because an LED indicator is employed as the operation indicator, the rated current is approximately 3.8 mA higher in the DC types and 0.5 to 5 mA higher in the AC types than in the standard type.

Ambient operating temperature: -55° to 60°C (-67° to 140°F).

Green LED DC
Red LED AC

Terminal arrangement/Internal connections (Bottom view)

MY4N

DC coil rating type

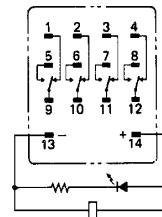

AC coil rating type

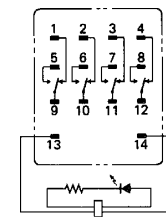

- Note:
1. In MY2N and MY3N, only the contact circuit is different from the illustration below. The coil terminals 10 and 11 of MY3N become (-) and (+), respectively.
 2. Pay special attention to the polarities when using the DC type.
 3. The AC coil-type is provided with a self-diagnostic function that detects a breakage in the coil.

RC Circuit

Specifications and dimensions same as the standard type with the following exceptions.

The panel cutout dimensions are the same as those of the standard type. However, the height is higher by 17.02 mm (0.67 in).

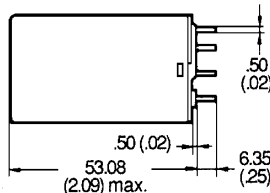

Terminal arrangement/Internal connections (Bottom view)

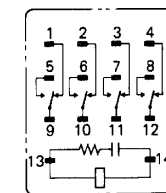

RC circuit
C : 0.033 μF
R : 120 Ω

- Note:
1. The above dimensioned drawing shows the 4-pole type. The dimensions of the 2- and 3-pole types are identical to the 4-pole type.
 2. Available on AC versions only.
 3. Terminal arrangement/internal connections: MY2-Y is the same as the standard type; MY2N-Y is the same as the LED indicator type.

Characteristic Data

Without RC circuit

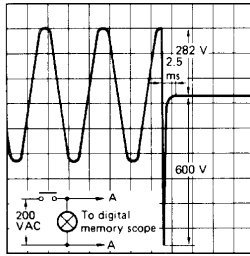

With RC circuit



Push-to-test button

MY□12

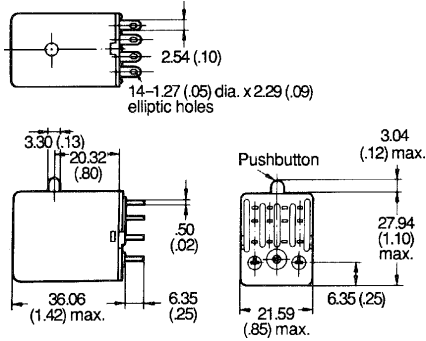

Mounting holes

When mounting the relay, use the connecting socket PYC-P2 shown in "ACCESSORIES" section. The mounting hole dimensions shown here are applicable to the relay with mounting stud.

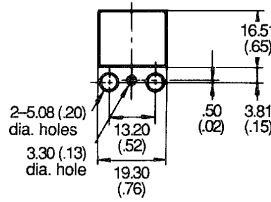

Note: The dimension drawings show the 4-pole type. The dimensions of the 2- and 3-pole types are identical to the 4-pole type.

Diode Surge Suppression

Specifications and dimensions same as the standard type with the following exceptions.

Terminal arrangement/internal connections: MY2(N)-D(2) is the same as the MY4(N)-D(2) with the exception of the contact configuration.

Ambient operating temperature: -55° to 60°C (-67° to 140°F).

Terminal arrangement/Internal connections (Bottom view)

MY4-D
6, 12, 24, 48
100/110 VDC



MY4N-D2
6, 12, 24, 48 VDC

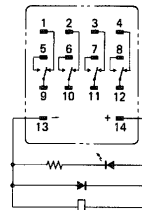

MY4N-D2
100/110 VDC



- Note:
1. Pay special attention to the polarities when using the DC type.
 2. The release time is somewhat longer, but satisfies the standard specifications of 25 ms.
 3. The reverse-breakdown voltage of the diode is 1,000 VDC.
 4. Available on DC versions only.

Connecting sockets

Use the standard MY4 (4PDT) sockets with the terminal arrangements listed below.

Terminal arrangement/Internal connections (Bottom view)

AC

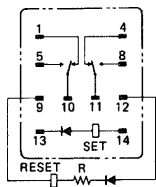

DC

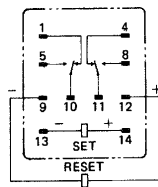

- Note:
1. R is a resistor for ampere-turn compensation, and is incorporated in the relays rated at 50 VAC or above.
 2. Pay attention to the polarity of the set and reset coils, as incorrect connection of positive and negative terminals will result in malfunctioning of the relay.

■ APPROVALS

UL recognized type (File No. E41515)

| Type | Contact form | Coil ratings | Contact ratings |
|--------|--------------|------------------------------|---|
| MY□ | DPDT | 6 to 240 VAC 6 to 120 VDC | 5 A, 120 VAC (Resistive) |
| | | | 5 A, 28 VDC (Resistive) |
| | 3PDT | | 5 A, 240 VAC (Inductive) |
| | | | 5 A, 28 VDC (Resistive) |
| | 4PDT | | 5 A, 240 VAC (Resistive) |
| | | | 3 A, 28 VDC (Resistive) |
| | | | 3 A, 120 VAC (Inductive) |
| | | | 1.5 A, 240 VAC (Inductive) |
| | | | 5 A, 240 VAC (Inductive, same polarity) |
| | | | 5 A, 28 VDC (Resistive, same polarity) |
| MY2K-□ | DPDT | 5 to 120 VAC 5 to 48 VDC | 3 A, 240 VAC (Resistive) 3 A, 28 VDC (Resistive) |

CSA certified type (File No. LR31928)

| Type | Contact form | Coil ratings | Contact ratings |
|--------|--------------------------------|------------------------------|---|
| MY□ | DPDT | 6 to 240 VAC 6 to 120 VDC | 5 A, 28 VDC (Resistive) |
| | | | 5 A, 240 VAC (Inductive) |
| | 3PDT | | 3 A, 28 VDC (Resistive) |
| | | | 3 A, 240 VAC (Inductive) |
| | | | 5 A, 240 VAC (Inductive, same polarity) |
| | | | 5 A, 28 VDC (Resistive, same polarity) |
| 4PDT | 3 A, 240 VAC (General purpose) | | |
| | 3 A, 30 VDC (Resistive) | | |
| MY2K-□ | DPDT | 5 to 120 VAC 5 to 48 VDC | 3 A, 240 VAC (General purpose) 3 A, 30 VDC (Resistive) |

LR (Lloyd's Register) approved type (File No. 563KOB-204524)

| Type | Contact form | Coil ratings | Contact ratings |
|------|--------------|------------------------------|----------------------------|
| MY□ | DPDT | 6 to 240 VAC 6 to 120 VDC | 2 A, 30 VDC (Inductive) |
| | | | 2 A, 200 VAC (Inductive) |
| | 4PDT | | 1.5 A, 30 VDC (Inductive) |
| | | | 0.8 A, 200 VAC (Inductive) |
| | | | 1.5 A, 115 VAC (Inductive) |

SEV listed type (File No. D791/63 [2- & 4-pole], D791/91 [3-pole])

| Type | Contact form | Coil ratings | Contact ratings |
|--------|--------------|--------------|--------------------------|
| MY□-SV | DPDT | 6 to 240 VAC | 5 A, 220 VAC (Resistive) |
| | 3PDT | 6 to 110 VDC | 5 A, 24 VDC (Resistive) |
| | 4PDT | | |

- Note: 1. The rated values approved by each of the safety standards (e.g., UL, CSA, VDE, and SEV) may be different from the performance characteristics individually defined in this catalog.
 2. In the interest of product improvement, specifications are subject to change.

■ HINTS ON CORRECT USE

When using the relay rated at 120 VAC at a supply voltage of 240 VAC, be sure to connect external resistors R_s and R_r to the relay.

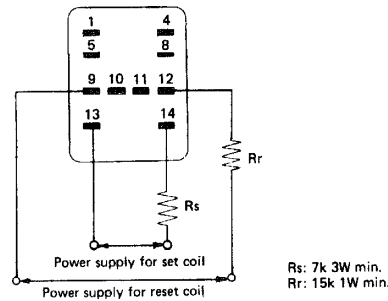

OMRON

OMRON ELECTRONICS, INC.

One East Commerce Drive
Schaumburg, IL 60173

1-800-55-OMRON

OMRON CANADA, INC.

885 Milner Avenue
Scarborough, Ontario M1B 5V8

416-286-6465

Cat. No. GC RLY6

9/97

Specifications subject to change without notice.

Printed in the U.S.A.