

2A, 50V - 1000V Surface Mount Rectifiers

FEATURES

- Glass passivated chip junction
- Ideal for automated placement
- Low forward voltage drop
- High surge current capability
- Compliant to RoHS Directive 2011/65/EU and in accordance to WEEE 2002/96/EC
- Halogen-free according to IEC 61249-2-21 definition



DO-214AC (SMA)

MECHANICAL DATA

Case: DO-214AC (SMA)

Molding compound, UL flammability classification rating 94V-0

Moisture sensitivity level: level 1, per J-STD-020

Part no. with suffix "H" means AEC-Q101 qualified

Packing code with suffix "G" means green compound (halogen-free)

Terminal: Matte tin plated leads, solderable per JESD22-B102

Meet JESD 201 class 2 whisker test

Polarity: Indicated by cathode band

Weight: 0.06 g (approximately)

MAXIMUM RATINGS AND ELECTRICAL CHARACTERISTICS (T _A =25°C unless otherwise noted)									
PARAMETER	SYMBOL	S2 AA	S2 BA	S2 DA	S2 GA	S2 JA	S2 KA	S2 MA	UNIT
Maximum repetitive peak reverse voltage	V _{RRM}	50	100	200	400	600	800	1000	V
Maximum RMS voltage	V _{RMS}	35	70	140	280	420	560	700	V
Maximum DC blocking voltage	V _{DC}	50	100	200	400	600	800	1000	V
Maximum average forward rectified current	I _{F(AV)}	1.5							A
Peak forward surge current, 8.3 ms single half sine-wave superimposed on rated load	I _{FSM}	50							A
Maximum instantaneous forward voltage (Note 1) @ 1.5 A	V _F	1.1							V
Maximum reverse current @ rated V _R	I _R	5 125							μA
Typical reverse recovery time (Note 2)	t _{tr}	1.5							μs
Typical junction capacitance (Note 3)	C _J	30							pF
Typical thermal resistance	R _{θJL} R _{θJA}	16 53							°C/W
Operating junction temperature range	T _J	- 55 to +150							°C
Storage temperature range	T _{STG}	- 55 to +150							°C

Note 1: Pulse test with PW=300μs, 1% duty cycle

Note 2: Reverse Recovery Test Conditions: I_F=0.5A, I_R=1.0A, I_{RR}=0.25A

Note 3: Measured at 1 MHz and Applied Reverse Voltage of 4.0V D.C.

ORDERING INFORMATION					
PART NO.	PART NO. SUFFIX	PACKING CODE	PACKING CODE SUFFIX	PACKAGE	PACKING
S2xA (Note 1)	H	R3	G	SMA	1,800 / 7" Plastic reel
		R2		SMA	7,500 / 13" Paper reel
		M2		SMA	7,500 / 13" Plastic reel
		F3		Folded SMA	1,800 / 7" Plastic reel
		F2		Folded SMA	7,500 / 13" Paper reel
		F4		Folded SMA	7,500 / 13" Plastic reel

Note 1: "x" defines voltage from 50V (S2AA) to 1000V (S2MA)

EXAMPLE					
PREFERRED PART NO.	PART NO.	PART NO. SUFFIX	PACKING CODE	PACKING CODE SUFFIX	DESCRIPTION
S2MAHR3G	S2MA	H	R3	G	AEC-Q101 qualified Green compound

RATINGS AND CHARACTERISTICS CURVES ($T_A=25^\circ\text{C}$ unless otherwise noted)

FIG. 1- MAXIMUM FORWARD CURRENT DERATING CURVE

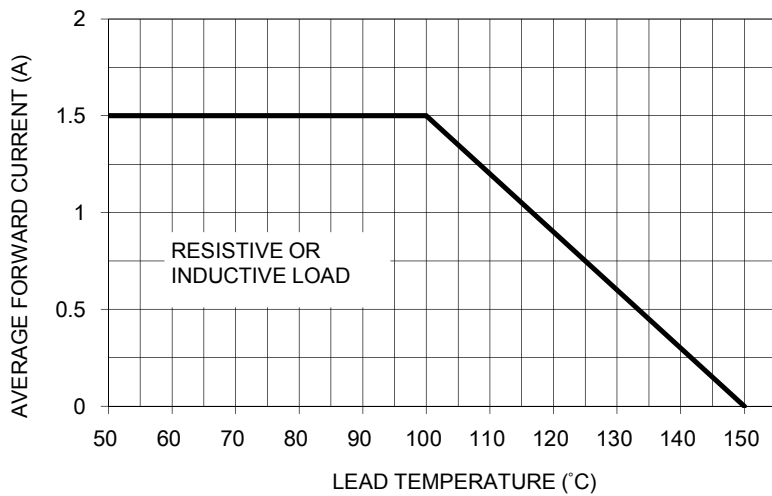

FIG. 2- TYPICAL REVERSE CHARACTERISTICS

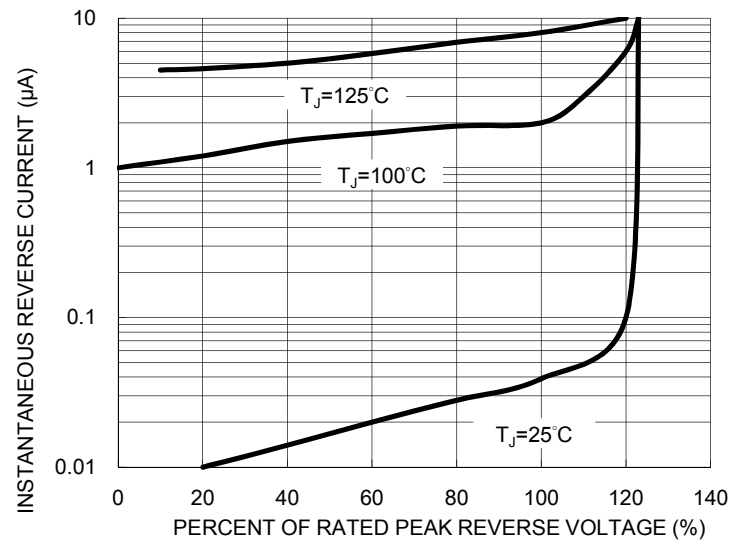

FIG. 3- MAXIMUM NON-REPETITIVE FORWARD SURGE CURRENT

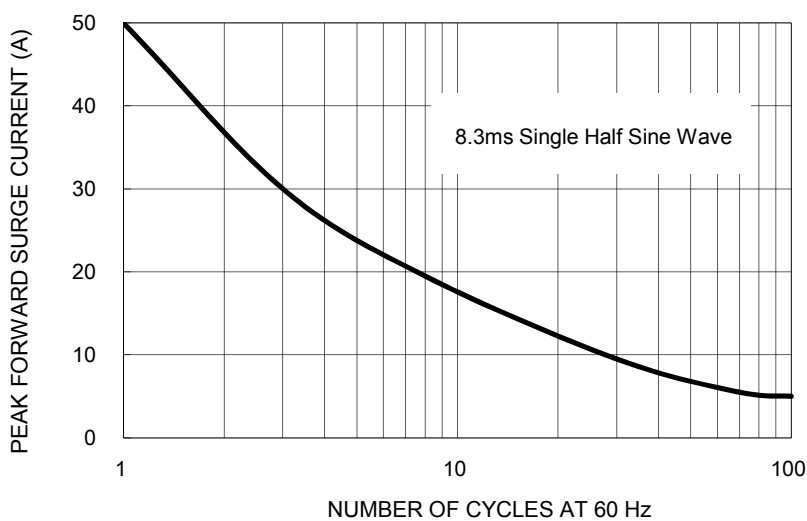

FIG. 4 TYPICAL FORWARD CHARACTERISTICS

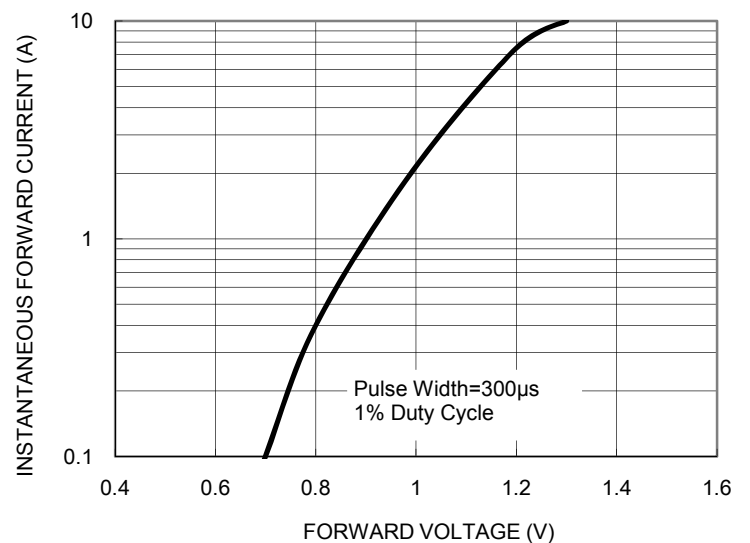

FIG. 5 TYPICAL JUNCTION CAPACITANCE

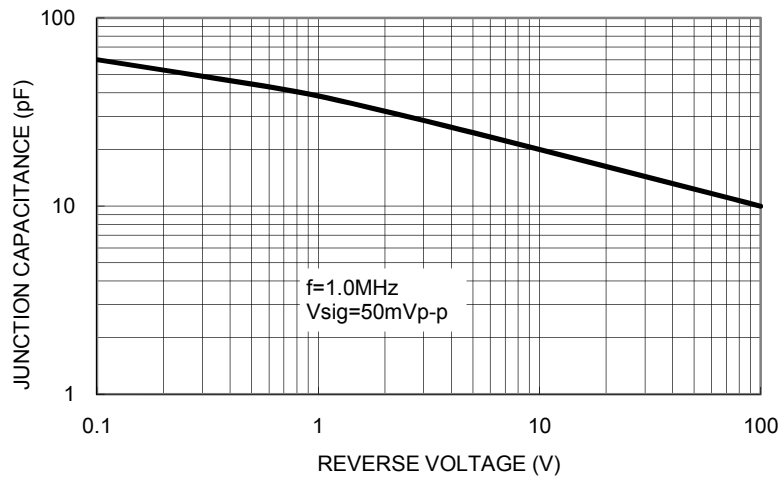
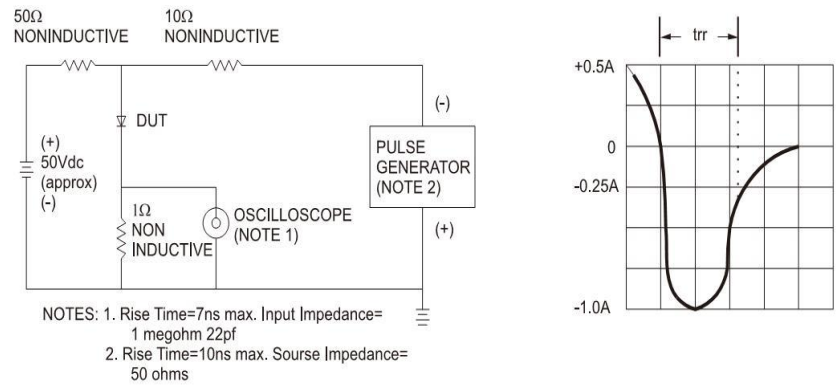
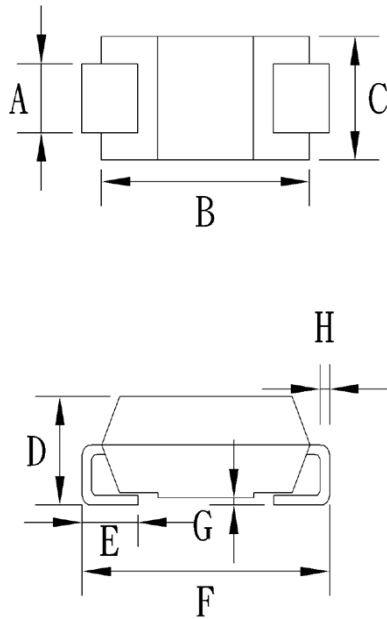

FIG.6- REVERSE RECOVERY TIME CHARACTERISTIC AND TEST CIRCUIT DIAGRAM



PACKAGE OUTLINE DIMENSIONS
DO-214AC (SMA)



DIM.	Unit (mm)		Unit (inch)	
	Min	Max	Min	Max
A	1.27	1.58	0.050	0.062
B	4.06	4.60	0.160	0.181
C	2.29	2.83	0.090	0.111
D	1.99	2.50	0.078	0.098
E	0.90	1.41	0.035	0.056
F	4.95	5.33	0.195	0.210
G	0.10	0.20	0.004	0.008
H	0.15	0.31	0.006	0.012

SUGGESTED PAD LAYOUT

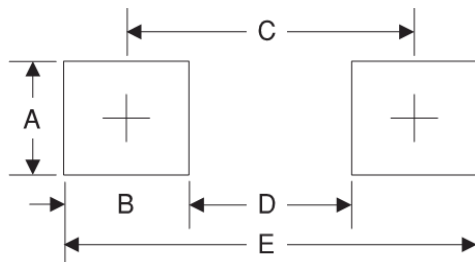

Symbol	Unit (mm)	Unit (inch)
A	1.68	0.066
B	1.52	0.060
C	3.93	0.155
D	2.41	0.095
E	5.45	0.215

MARKING DIAGRAM



- P/N = Specific Device Code
- G = Green Compound
- YW = Date Code
- F = Factory Code

Notice

Specifications of the products displayed herein are subject to change without notice. TSC or anyone on its behalf, assumes no responsibility or liability for any errors or inaccuracies.

Information contained herein is intended to provide a product description only. No license, express or implied, to any intellectual property rights is granted by this document. Except as provided in TSC's terms and conditions of sale for such products, TSC assumes no liability whatsoever, and disclaims any express or implied warranty, relating to sale and/or use of TSC products including liability or warranties relating to fitness for a particular purpose, merchantability, or infringement of any patent, copyright, or other intellectual property right.

The products shown herein are not designed for use in medical, life-saving, or life-sustaining applications. Customers using or selling these products for use in such applications do so at their own risk and agree to fully indemnify TSC for any damages resulting from such improper use or sale.

Mouser Electronics

Authorized Distributor

Click to View Pricing, Inventory, Delivery & Lifecycle Information:

Taiwan Semiconductor:

[S2AA](#) [S2DA](#) [S2GA](#) [S2JA](#) [S2KA](#) [S2MA](#) [S2DA F2](#) [S2AA F2G](#) [S2JA F2](#) [S2KA R2G](#) [S2BA F2](#) [S2BA F3](#) [S2DA F2G](#) [S2JA R3G](#) [S2AA F3G](#) [S2JA R2](#) [S2JA F3](#) [S2KA F2](#) [S2MA F2](#) [S2KA F2G](#) [S2GA R2](#) [S2KA F3](#) [S2MA F3G](#) [S2DA R3](#) [S2JA F3G](#) [S2AA R3](#) [S2BA R2G](#) [S2KA F3G](#) [S2GA R3](#) [S2MA F3](#) [S2AA F2](#) [S2AA R3G](#) [S2GA R3G](#) [S2AA R2](#) [S2GA R2G](#) [S2BA F2G](#) [S2BA R2](#) [S2DA F3](#) [S2BA R3G](#) [S2MA R2G](#) [S2MA R2](#) [S2JA R3](#) [S2GA F3](#) [S2AA R2G](#) [S2MA F2G](#) [S2KA R2](#) [S2JA F2G](#) [S2MA R3](#) [S2KA R3](#) [S2JA R2G](#) [S2GA F2G](#) [S2DA R3G](#) [S2DA F3G](#) [S2GA F3G](#) [S2MA R3G](#) [S2BA R3](#) [S2BA F3G](#) [S2DA R2G](#) [S2KA R3G](#) [S2GA F2](#) [S2DA R2](#) [S2AA F3](#)