

Overview

- 0 ... 2 mm
- voltage output
- flylead connector PVC M8, L=200 mm
- 10 ... 60 °C
- IP 67



Picture similar



Technical data

General data

Mounting type	Flush
Measuring distance Sd	0 ... 2 mm
Resolution	< 0,001 mm (stat.) < 0,005 mm (dynam.)
Repeat accuracy	< 0,02 mm
Linearity error	± 120 µm
Temperature drift	± 5 % (Full Scale)

Electrical data

Response time (factory characteristic)	< 1 ms
Voltage supply range +Vs	12 ... 30 VDC
Current consumption max. (no load)	8 mA
Output circuit	Voltage output

Electrical data

Output signal	0 ... 10 VDC
Load resistance	> 4000 Ohm
Short circuit protection	Yes
Reverse polarity protection	Yes

Mechanical data

Type	Rectangular
Housing material	Die-cast zinc nickel plated
Dimension	8 mm
Housing length	16 mm
Connection types	Flylead connector PVC M8, L=200 mm
Tightening torque max.	0.8 Nm

Ambient conditions

Operating temperature	10 ... +60 °C
Protection class	IP 67

Remarks

- Extra flat housing
- Through bore for M3 screw
- Standard cable length 200 mm (L)

Dimension drawing

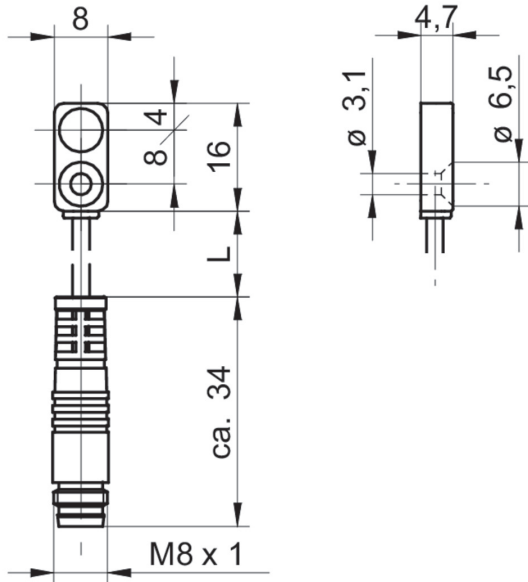

Connection diagram

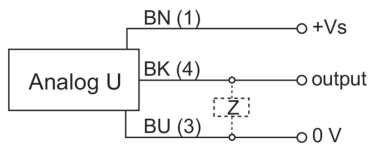

Pin assignment

