



## 3D Printed Camera LED Ring

Created by Ruiz Brothers



Last updated on 2018-08-22 03:39:34 PM UTC

## Guide Contents

Guide Contents	2
Overview	3
DIY LED Ring Light	3
Prerequisite Guide:	3
Parts List:	4
Tools & Supplies	4
Photography Lighting	4
3D Printing	5
Transparent PLA	5
Circuit Diagram	7
Prototyping Circuit	8
Programming Trinket	8
Setting RGB color values	8
24 NeoPixel Ring	10
Power Circuit	10
Wiring	10
Connecting NeoPixel Ring	11
Mounting NeoPixel Ring	11
Connecting Base to Hinge	12
Connecting Clip	12
Connecting Enclosure	13
Connecting Trinket	13
Mounting Trinket + Battery	14
60 NeoPixel Ring	16

## Overview



### DIY LED Ring Light

Trying to get those pixel perfect macro shots on a budget? Build your own DIY low cost ring of light with a NeoPixel Ring and Trinket, Adafruit tiny arduino micro controller. The color and brightness of the LEDs can be programmed to color or pattern!

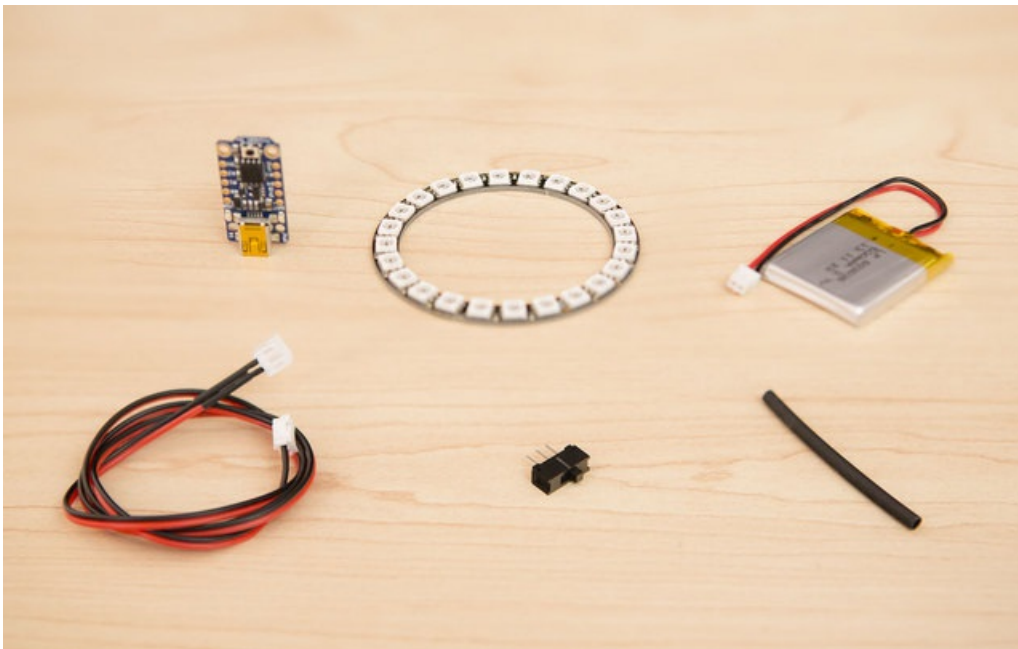

### Prerequisite Guide:

- [NeoPixel UberGuide \(https://adafru.it/dhw\)](https://adafru.it/dhw)
- [Introducing Trinket \(https://adafru.it/dhx\)](https://adafru.it/dhx)

## Parts List:

- [24 NeoPixel Ring \(http://adafru.it/1586\)](http://adafru.it/1586)
- [Lithium ion Polymer Battery 500 \(http://adafru.it/1578\)](http://adafru.it/1578)
- [JST Battery Extension \(http://adafru.it/1131\)](http://adafru.it/1131)
- [Adafruit 5V Trinket \(http://adafru.it/1501\)](http://adafru.it/1501)
- [Slide Switch \(http://adafru.it/805\)](http://adafru.it/805)

## Tools & Supplies

- [Soldering Iron \(https://adafru.it/c7b\)](https://adafru.it/c7b)
- [60/40 rosin-core solder \(http://adafru.it/145\)](http://adafru.it/145)
- [30 gauge wire wrap \(http://adafru.it/1446\)](http://adafru.it/1446)
- [Wire Cutter/Strippers \(http://adafru.it/527\)](http://adafru.it/527)

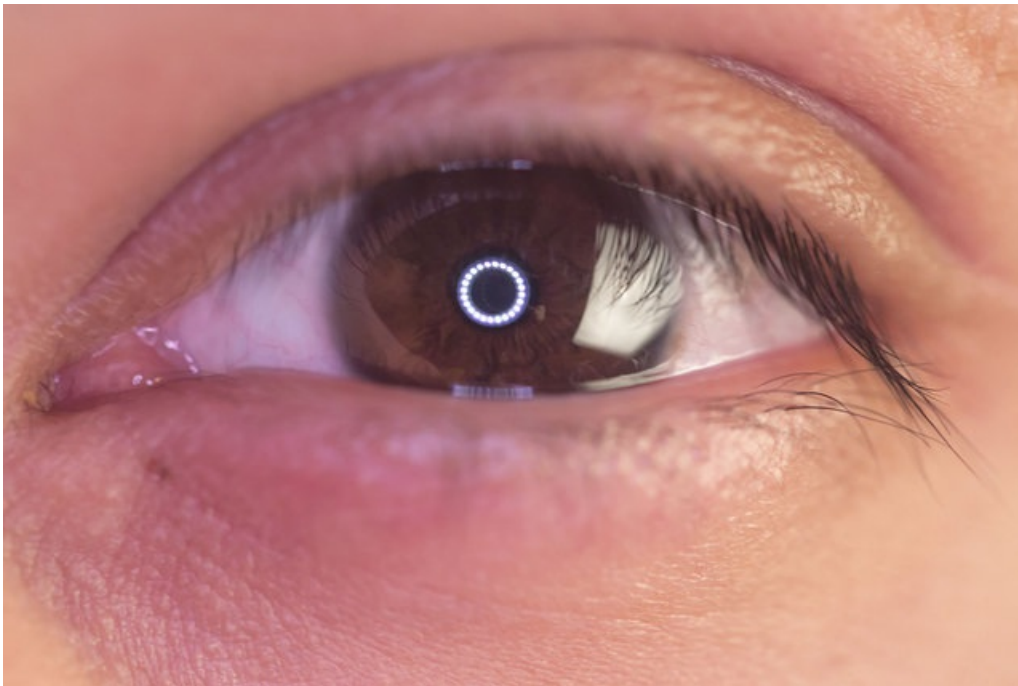

## Photography Lighting

Using the 24x NeoPixel ring as a light ring is a great way to enhance macro-photography. A ring of light provides a spot-light effect, removing shadows caused by the camera getting in front of the subject. In our test shots above the NeoPixel ring projects a ring of light inside the eye.

## 3D Printing

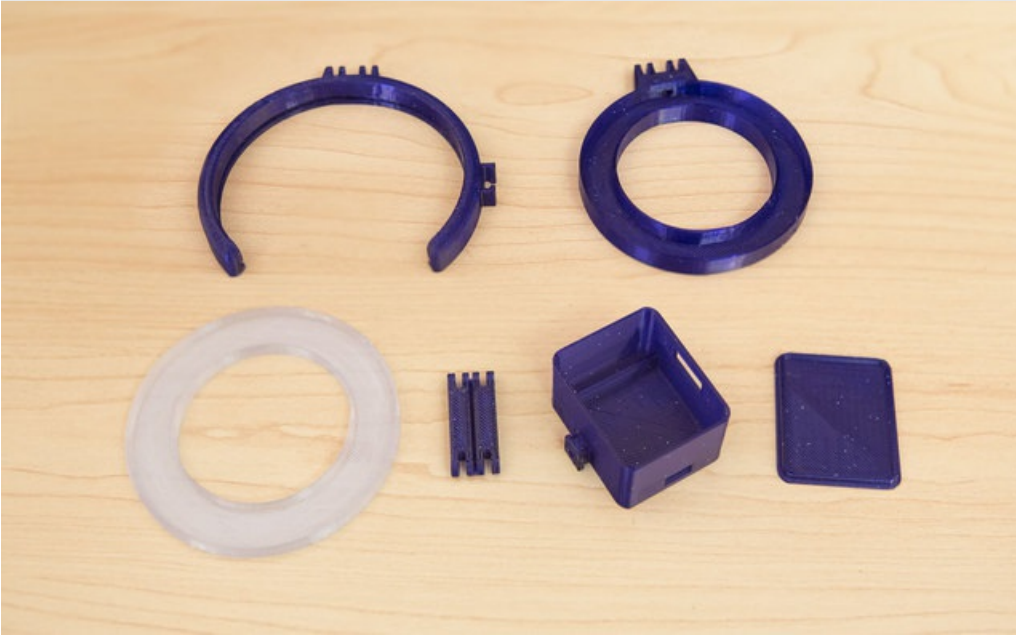

<https://adafru.it/d7z>

<https://adafru.it/d7z>

### Transparent PLA

Print the LED cover to soften and diffuse the NeoPixel ring. For most FDM 3D printers, PLA material works with out a heated bed. The extruder should be set to 230c. The model was design to print with out a raft or supports. Below is a small list of places to get PLA. Make sure your filaments diameter size matches your 3d printer. Most common size is 1.75mm and 3mm.

- [Inventibles \(https://adafru.it/d5T\)](https://adafru.it/d5T)
- [Makerbot \(https://adafru.it/d5U\)](https://adafru.it/d5U)
- [Ultimachine \(https://adafru.it/d5V\)](https://adafru.it/d5V)
- [Amazon \(https://adafru.it/Bp2\)](https://adafru.it/Bp2)
- [3D Printer Ninja \(https://adafru.it/d9P\)](https://adafru.it/d9P)

LED Base About 35 minutes 5g	PLA @230 No Raft No Support	2 shells 15% Infill 2.0 Layer Height 90/150mm/s
Enclosure + Cover About 40 minutes 6g	PLA @230 No Raft No Support	2 shells 15% Infill 2.0 Layer Height 90/150mm/s
Clip About 35 minutes 7g	PLA @230 No Raft No Support	2 shells 15% Infill 2.0 Layer Height 90/150mm/s
Hinge Connector About 5 minutes 1g	PLA @230 No Raft No Support	2 shells 15% Infill 2.0 Layer Height 90/150mm/s
LED Diffuser About 20 minutes 4g	Transparent PLA @230 No Raft No Support	2 shells 15% Infill 2.0 Layer height 90/150mm/s

# Circuit Diagram

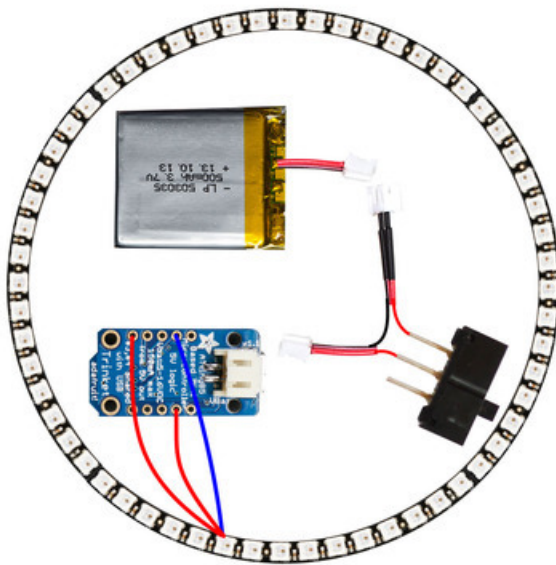
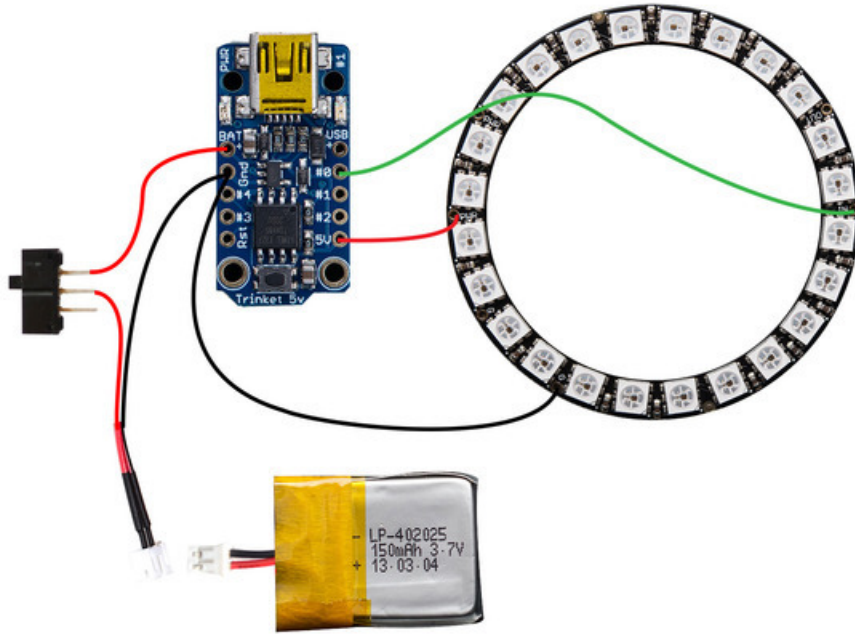

## Prototyping Circuit

Please be sure to check out [NeoPixel Guide \(https://adafru.it/cEz\)](https://adafru.it/cEz) to get a better understanding of how to power and work with NeoPixels.

Use a bread board and alligator clips to connect the components together. You will want to solder header pins onto the 5V Trinket for a secure connection when prototyping on a breadboard.

- **GND** NeoPixel Ring connects to **GND** on 5V Trinket
- **IN** NeoPixel Ring connects to **GIO#0**
- **PWR** NeoPixel connects to **5V**
  
- **Pin 1** Slide Switch connects to **BAT** on 5V Trinket
- **Pin 2** Slide Switch connects to **Positive** wire of JST Extender
- **Negative** wire of JST Extender connects to **GND** on 5V Trinket

## Programming Trinket

Please check out the [NeoPixel Arduino Library guide \(https://adafru.it/cYJ\)](https://adafru.it/cYJ) to get a better understanding on how to program your own colors and animations.

```
#include <Adafruit_NeoPixel.h>

#define N_PIXELS 24 // Number of pixels you are using
#define LED_PIN 0 // NeoPixel LED strand is connected to GPIO #0 / D0

Adafruit_NeoPixel strip = Adafruit_NeoPixel(N_PIXELS, LED_PIN, NEO_GRB + NEO_KHZ800);

void setup() {
  strip.begin();

  // you can change the brightness to lower if its too bright!
  strip.setBrightness(255); // Set LED brightness 0-255
  colorWipe(strip.Color(255, 255, 255),0); // fill the strip with all white
  strip.show(); // Update strip
}

void loop() {
}

// Fill the dots one after the other with a color
void colorWipe(uint32_t c, uint8_t wait) {
  for(uint16_t i=0; i<strip.numPixels(); i++) {
    strip.setPixelColor(i, c);
    strip.show();
  }
}
```

## Setting RGB color values

You can quickly set the color of the LEDs by changing the three values that make up a color. See the "255,255,255" values in the colorWipe line of code, you can change these three values to create a custom color of your choice! The brightness can be adjusted by changing the '255' value in the 'setBrightness' line of code.





## 24 NeoPixel Ring

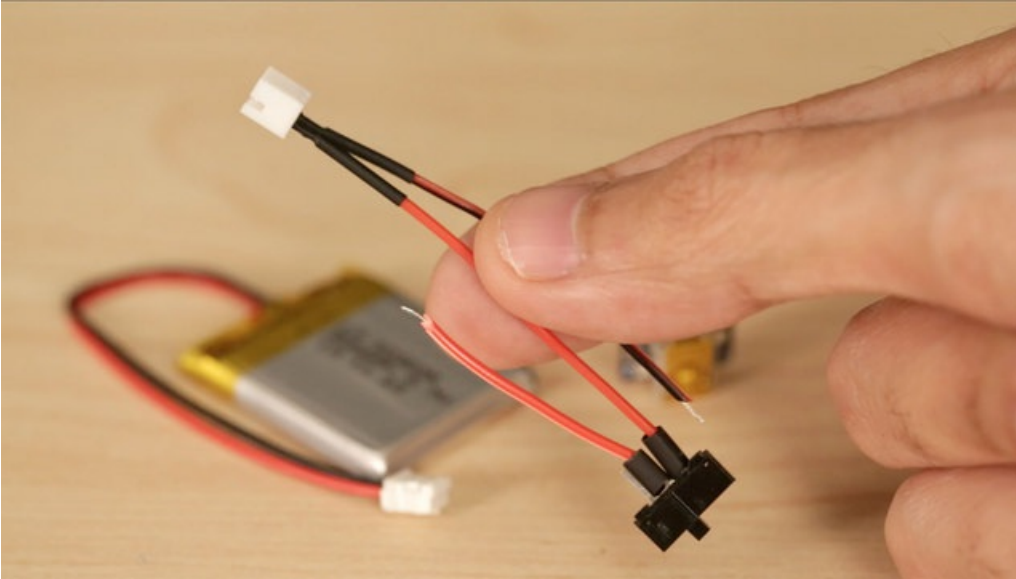

### Power Circuit

Use the JST extender to create a removable battery circuit. Cut and stripe the JST extender to about 30mm in length. Solder a pin on the slide switch to the positive wire of the JST extender. Use small pieces of shrink tubing to secure and protect the soldered connections.



### Wiring

Measure, cut and strip 3 strips of 30 gauge wire wrap to about 160mm in length. Group together the 3 wires and thread them through the middle hole in the 3d printed base that will hold the NeoPixel Ring.

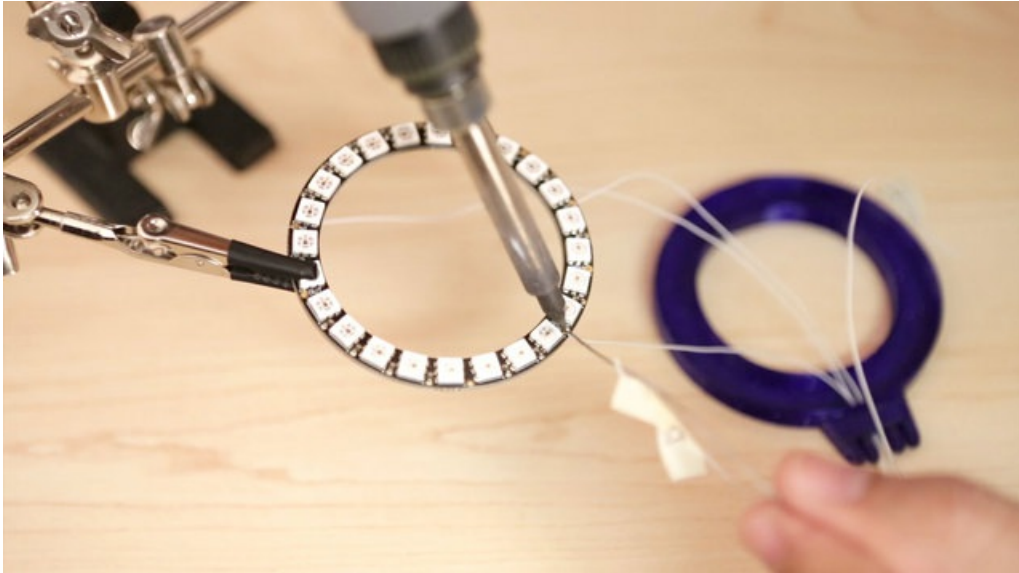

### Connecting NeoPixel Ring

Pull the wires through the base enough to mount the ring with a third helping hand Label each wire and solder them to the appropriate pins of the NeoPixel Ring.



### Mounting NeoPixel Ring

Carefully bend the "IN" cable underneath the ring and pull each cable until it's taut. Align the NeoPixel ring into position and use double sided tape to secure the ring to the base.

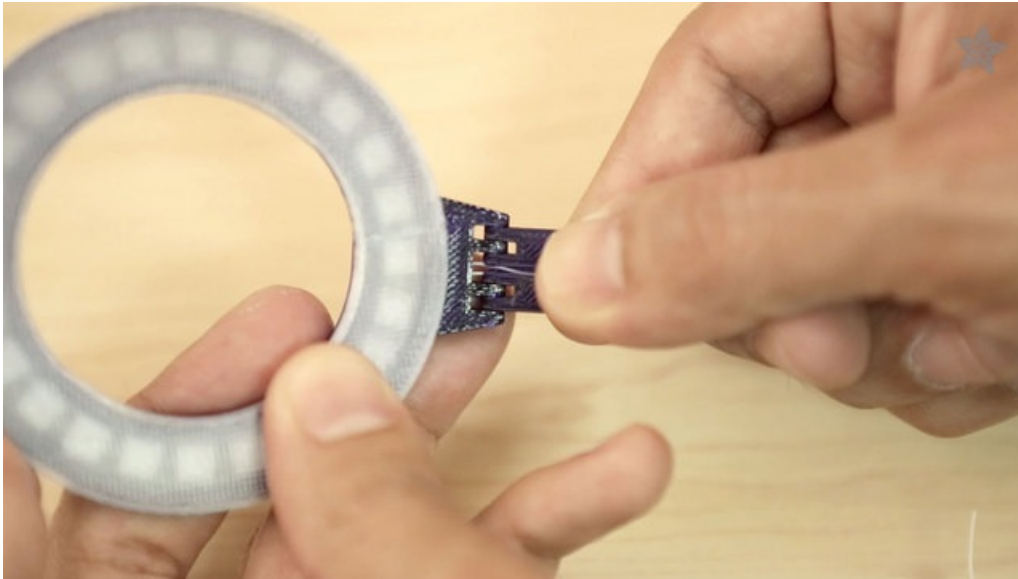

### Connecting Base to Hinge

Snap the hinge on to the base and nest the wires inside the cavity of the connector. Cut a small piece of a paper clip and slide it into the hole of the hinge securing the two pieces together.



### Connecting Clip

Attach the clip to the other side of the connector and apply another piece of paper clip joining the three pieces together. Pull the wiring through the clip and leave a little bit of slack so the wires can curve around the inside the cavity of the clip.



### Connecting Enclosure

Pull the wiring through the hole on the side of the enclosure and connect it to the clip by sliding it into place. Use electrical tape to secure the wires inside the clip cavity.

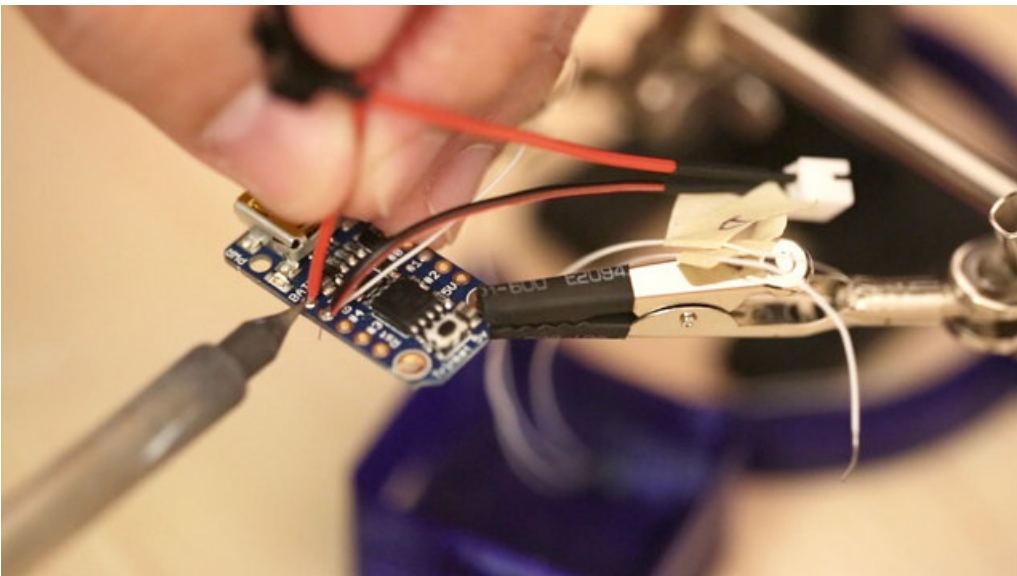

### Connecting Trinket

Solder the wires to the appropriate pins on the 5V Trinket. **GND** wire connects to the **GND** pin while the positive wire connects to the **5V** pin. You can choose which GIO pin will connect to the digital out signal of the NeoPixel ring, we used **GIO#0**. Connect the power circuit to the trinket by soldering one pin of the slide switch to **GND** and the other pin to the **BAT** positive pin. The **GND** pin should be shared to the NeoPixel and the power circuit.

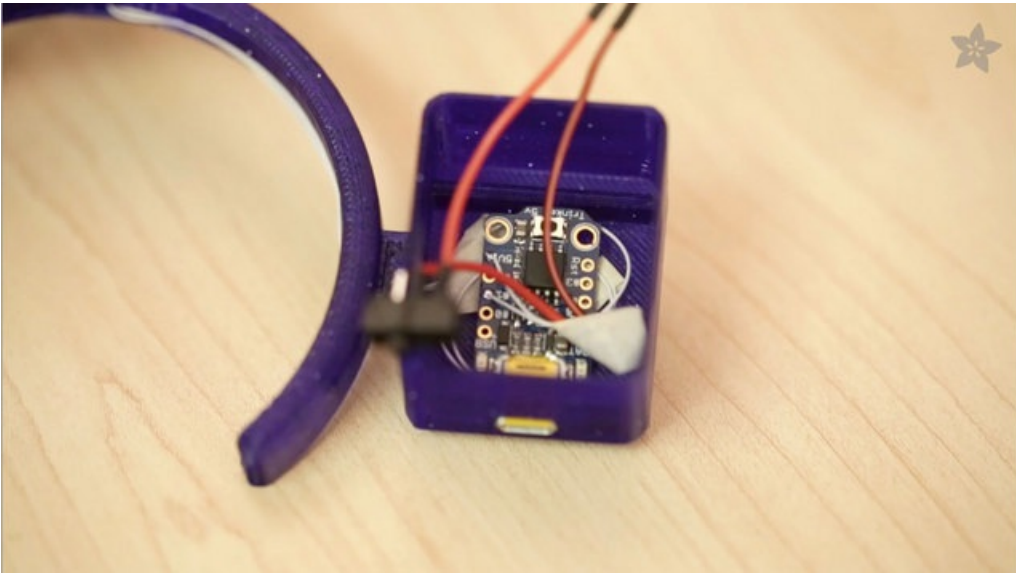

### Mounting Trinket + Battery

Carefully position the wired 5V Trinket into the enclosure. Align the USB port to the opening hole at the bottom of the enclosure. Position the 500mAh Lithium battery onto of the trinket wit the power circuit on top.

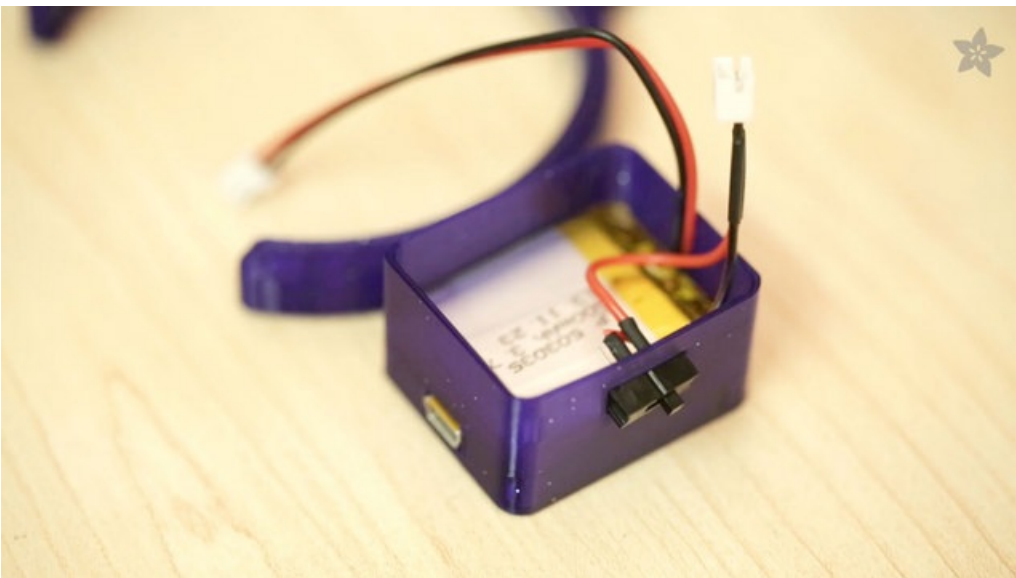

Plug the battery into the JST extender and insert the slide switch through the top opening by pressing it through the top hole of the enclosure.

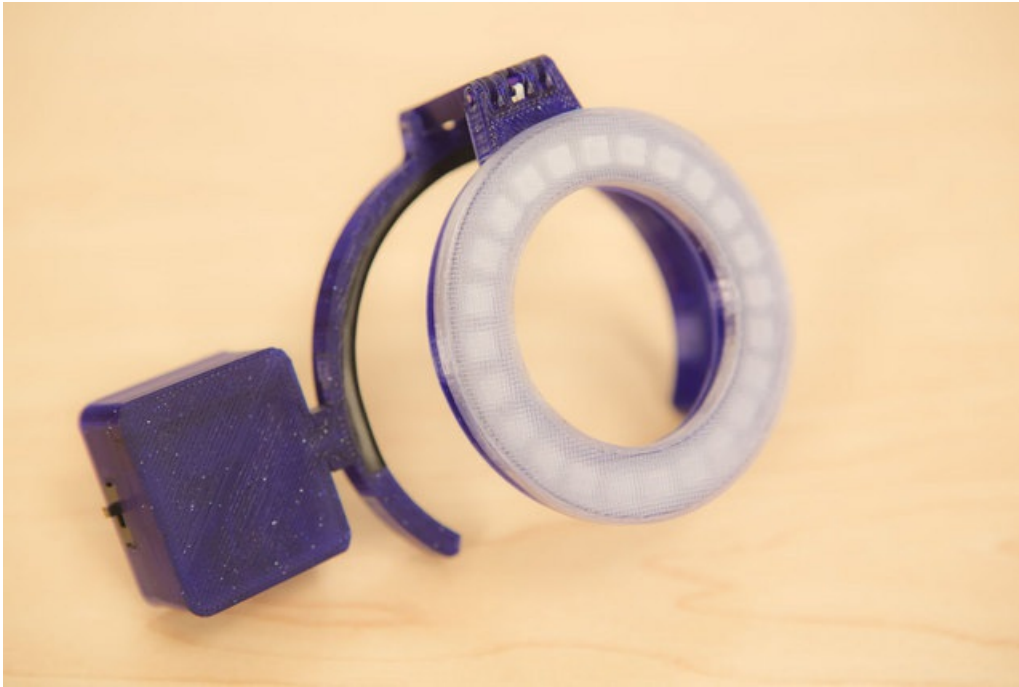

Close up the enclosure by snapping the lid on and slide the switch on to power up the ring! The clip snaps onto most DSLR camera lenses such as the 100mm or 24-70mm prime lenses.

Since all-LEDs-on can be really power-consuming, we suggest adjusting the brightness with the NeoPixel `setBrightness()` command to 100 or less

## 60 NeoPixel Ring

Bigger and better!

This upgrade turns a 60x NeoPixel Ring into our biggest camera light yet. Featuring a universal hot shoe, the light can mount on ANY camera and ANY lens. This update uses the same micro-controller and battery.

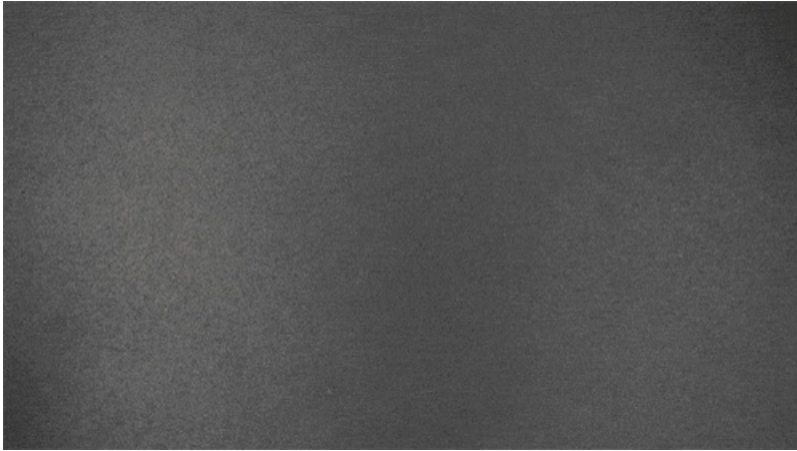

<https://adafru.it/dhz>

<https://adafru.it/dhz>

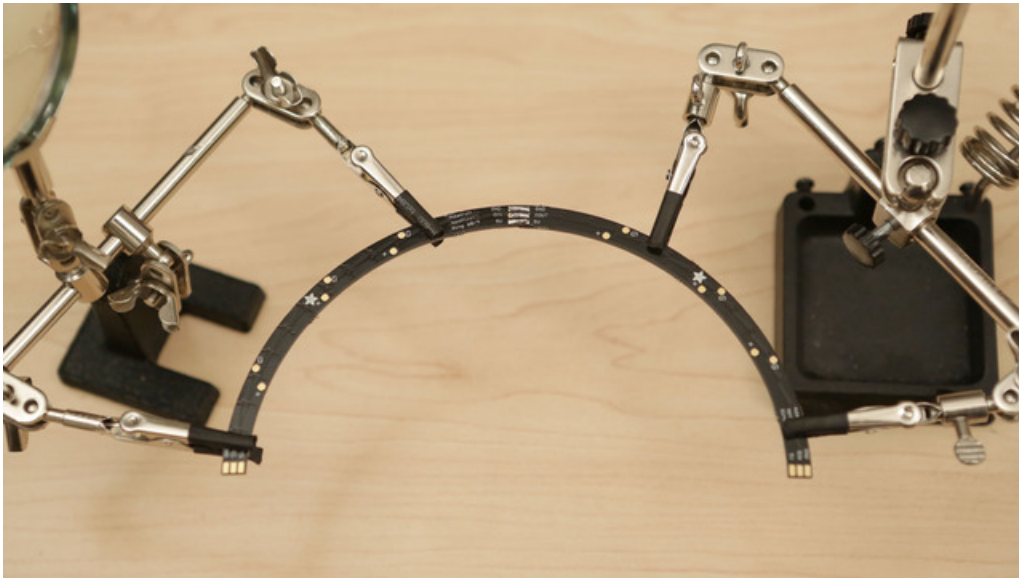

You need 4 pieces of the [60x NeoPixel ring \(http://adafru.it/1768\)](http://adafru.it/1768) to make a full working LED ring! The pieces themselves do not come soldered together, so you will have to sold them! You can use two third-helping hands to assist in soldering the pieces together. A piece of shrink tubing added to the little grabbers ensure you don't mark up the PCBs.



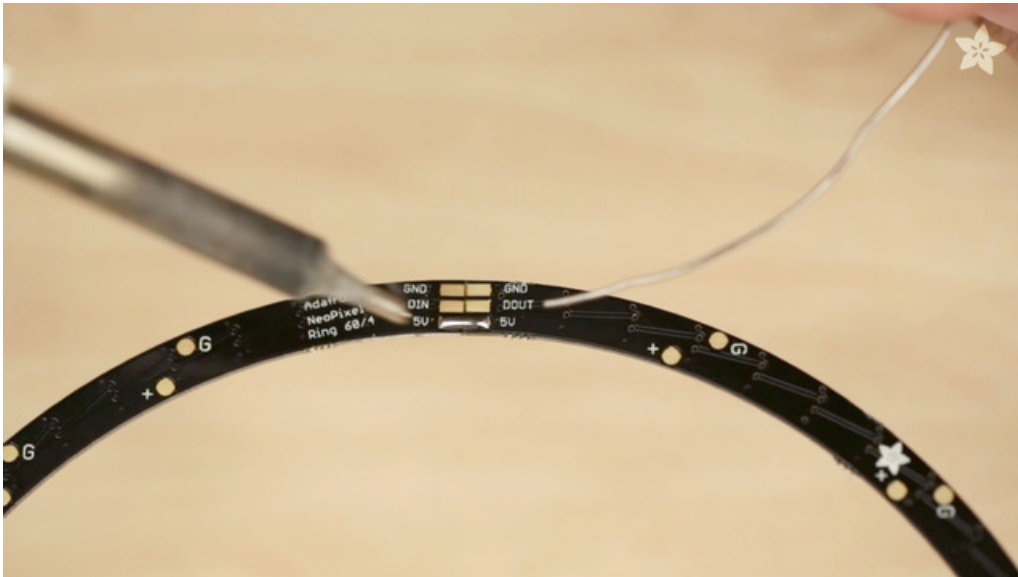

Start by soldering just two pieces together. Once you've aligned them up, apply a line of solder from one connection to the other. Make two sets of halves and solder those together.



With two halves soldered together, you can orient the ring and the third-helping hands to a comfortable position. Align them up as best as you can and solder these together.

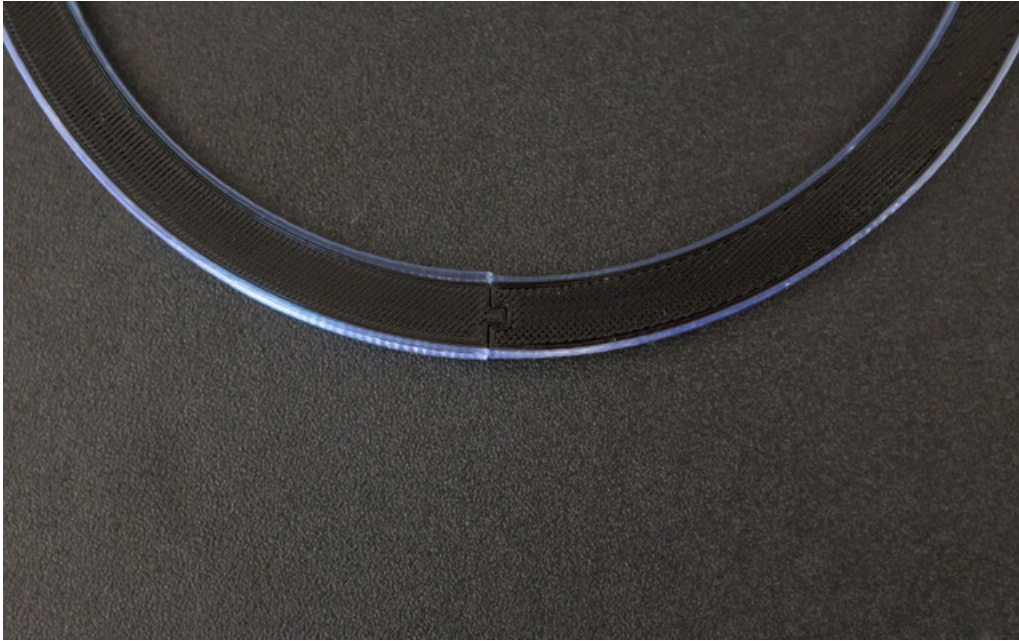

The `neoring-60-top.stl` and `neoring-60-bottom.stl` parts are the two pieces that snap together to make the large ring. The `neoring-60-cap-top.stl` and `neoring-60-cap-bottom.stl` parts are also two parts that snap together, these are to be printed in transparent PLA to diffuse the LEDs.

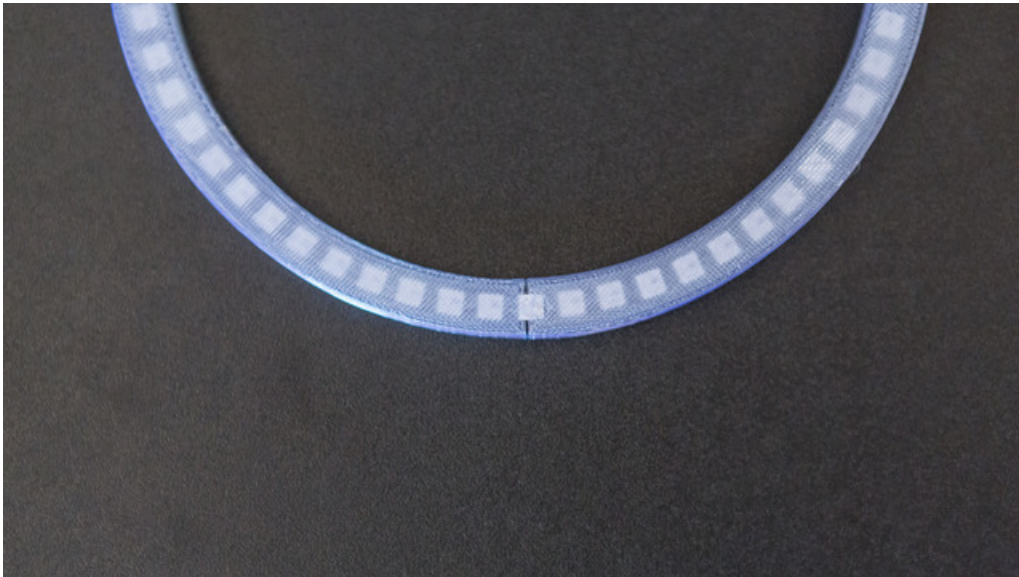

Join the two holder parts together by snapping the tabs on the ends together. Carefully insert the 60 NeoPixel ring into the assembled holder. Thread the wires through the hole of the `neoring-60-bottom.stl` and out the hinge connector.

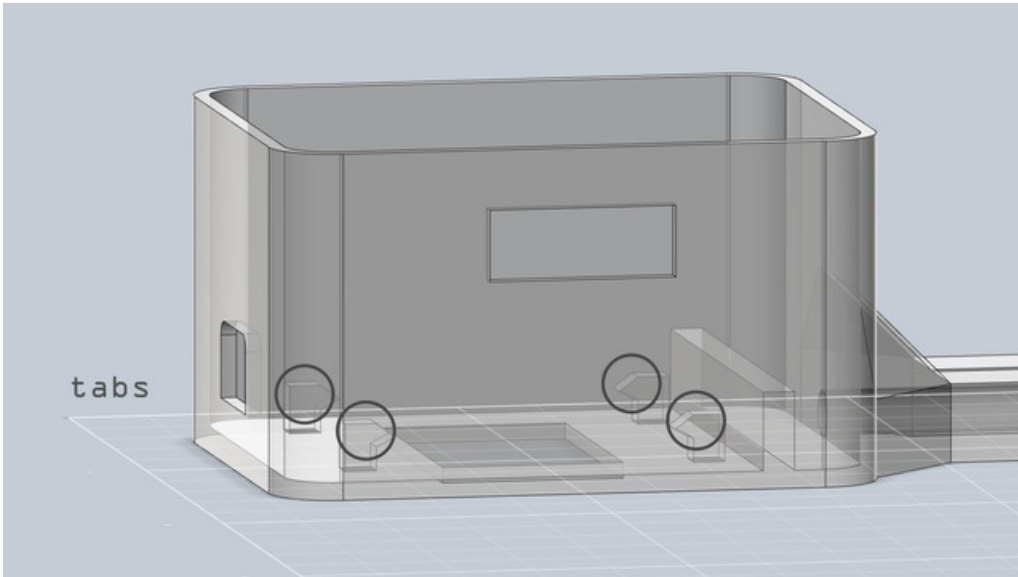

The **box.stl** part houses the 500mAh lipo battery and Trinket. At the bottom of the enclosure, the opening with tabs allows the **connector.stl** part to mount to the **hotshot.stl** part to the enclosure.

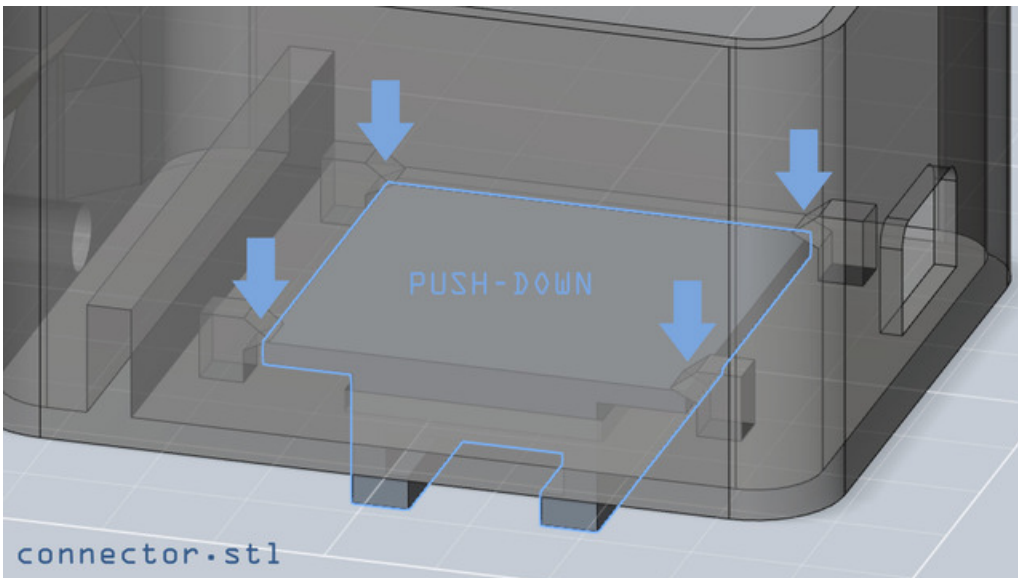

Insert the **connector.stl** part inside the enclosure, through the bottom opening with the flat end facing up. Apply pressure to the corners of the connector to snap them into place.

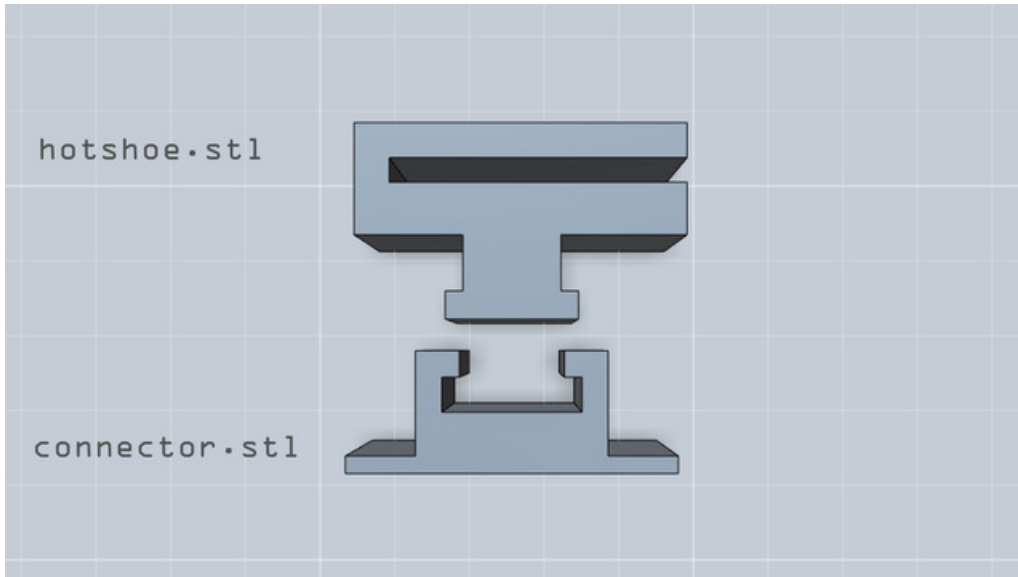

Firmly slide the `hotshoe.stl` part through the `connector.stl` part where the two sides interlock. The small "T" shape on the side of the `hotshoe.stl` part meets with the "C" shape of the `connector.stl` part.



### Powering

The [500mAh Lithium Ion Polymer battery](https://adafru.it/dhK) is small enough to fit inside the `box.stl` enclosure but only provides about 30 minutes of use when powering 60 NeoPixels at a low brightness (we recommend a brightness setting of 20-ish). For full brightness, you'll need a bigger battery, 2200mAh or higher, or using a [USB battery bank](https://adafru.it/dgz).

# Mouser Electronics

Authorized Distributor

Click to View Pricing, Inventory, Delivery & Lifecycle Information:

[Adafruit:](#)

[1768](#) [2873](#) [2874](#) [2875](#)