

# Reference Only

Spec.No.JENF243A-0020AG-01

P1/9

## Chip Ferrite Bead BLM03□□□□SN1□ Reference Specification

### 1.Scope

This reference specification applies to Chip Ferrite Bead BLM03\_SN Series.

### 2.Part Numbering

(ex.) BL M 03 AG 121 S N 1 D  
 (1) (2) (3) (4) (5) (6) (7) (8) (9)

(1)Product ID (2)Type (3)Dimension(L×W) (4)Characteristics (5)Typical Impedance at 100MHz  
 (6)Performance (7)Category (8)Numbers of Circuit (9)Packaging(D:Taping / B:Bulk)

### 3.Rating

| Customer Part Number | MURATA Part Number               | Impedance (Ω)<br>(at 100MHz, Under Standard Testing Condition) |      | Rated Current (mA) |          | DC Resistance (Ω max.) |                      | Remark          |                   |
|----------------------|----------------------------------|--|------|--------------------|----------|------------------------|----------------------|-----------------|-------------------|
|                      |                                  | Typical  |      | at 85°C            | at 125°C | Initial Values         | Values After Testing |                 |                   |
|                      | BLM03AG100SN1D<br>BLM03AG100SN1B | 5 to 15  | 10   | 500                |          | 0.1                    | 0.15                 | For general use |                   |
|                      | BLM03AG700SN1D<br>BLM03AG700SN1B | 40 to 100  | 70   | 200                |          | 0.4                    | 0.5                  |                 |                   |
|                      | BLM03AG800SN1D<br>BLM03AG800SN1B | 80±25%   | 80   | 200                |          | 0.4                    | 0.5                  |                 |                   |
|                      | BLM03AG121SN1D<br>BLM03AG121SN1B | 120±25%  | 120  | 200                |          | 0.5                    | 0.6                  |                 |                   |
|                      | BLM03AG241SN1D<br>BLM03AG241SN1B | 240±25%  | 240  | 200                |          | 0.8                    | 0.9                  |                 |                   |
|                      | BLM03AG601SN1D<br>BLM03AG601SN1B | 600±25%  | 600  | 100                |          | 1.5                    | 1.6                  |                 |                   |
|                      | BLM03AG102SN1D<br>BLM03AG102SN1B | 1000±25%   | 1000 | 100                |          | 2.5                    | 2.6                  |                 |                   |
|                      | BLM03AX100SN1D<br>BLM03AX100SN1B | 5~15   | 10   | 1000               |          | 0.05                   | 0.10                 |                 |                   |
|                      | BLM03AX800SN1D<br>BLM03AX800SN1B | 80±25%   | 80   | 500                |          | 0.18                   | 0.23                 |                 |                   |
|                      | BLM03AX121SN1D<br>BLM03AX121SN1B | 120±25%  | 120  | 450                |          | 0.23                   | 0.28                 |                 |                   |
|                      | BLM03AX241SN1D<br>BLM03AX241SN1B | 240±25%  | 240  | 350                |          | 0.38                   | 0.43                 |                 |                   |
|                      | BLM03AX601SN1D<br>BLM03AX601SN1B | 600±25%  | 600  | 250                |          | 0.85                   | 0.90                 |                 |                   |
|                      | BLM03AX102SN1D<br>BLM03AX102SN1B | 1000±25%   | 1000 | 200                |          | 1.25                   | 1.30                 |                 |                   |
|                      | BLM03PG220SN1D<br>BLM03PG220SN1B | 22±25%   | 22   | 900                |          | 0.065                  | 0.115                |                 | For DC power Line |
|                      | BLM03PG330SN1D<br>BLM03PG330SN1B | 33±25%   | 33   | 750                |          | 0.090                  | 0.140                |                 |                   |
|                      | BLM03PX220SN1D<br>BLM03PX220SN1B | 22±25%   | 22   | 1800*1             | 1450*1   | 0.040                  | 0.045                |                 |                   |
|                      | BLM03PX330SN1D<br>BLM03PX330SN1B | 33±25%   | 33   | 1500*1             | 1200*1   | 0.055                  | 0.060                |                 |                   |
|                      | BLM03PX800SN1D<br>BLM03PX800SN1B | 80±25%   | 80   | 1000*1             | 800*1    | 0.130                  | 0.135                |                 |                   |
|                      | BLM03PX121SN1D<br>BLM03PX121SN1B | 120±25%  | 120  | 900*1              | 700*1    | 0.160                  | 0.210                |                 |                   |

# Reference Only

| Customer Part Number | MURATA Part Number | Impedance ( $\Omega$ )<br>(at 100MHz, Under Standard Testing Condition) |         | Rated Current (mA) |                | DC Resistance ( $\Omega$ max.) |                            | Remark |
|----------------------|--------------------|---|---------|--------------------|----------------|--------------------------------|----------------------------|--------|
|                      |                    | Typical   | at 85°C | at 125°C           | Initial Values | Values After Testing           |                            |        |
|                      |                    |   |         |                    |                |                                |                            |        |
|                      | BLM03BB100SN1D     | 10 $\pm$ 25%  | 10      | 300                | 0.4            | 0.5                            | For high speed signal Line |        |
|                      | BLM03BB100SN1B     |   |         |                    |                |                                |                            |        |
|                      | BLM03BB220SN1D     | 22 $\pm$ 25%  | 22      | 200                | 0.5            | 0.6                            |                            |        |
|                      | BLM03BB220SN1B     |   |         |                    |                |                                |                            |        |
|                      | BLM03BB470SN1D     | 47 $\pm$ 25%  | 47      | 200                | 0.7            | 0.8                            |                            |        |
|                      | BLM03BB470SN1B     |   |         |                    |                |                                |                            |        |
|                      | BLM03BB750SN1D     | 75 $\pm$ 25%  | 75      | 200                | 1.0            | 1.1                            |                            |        |
|                      | BLM03BB750SN1B     |   |         |                    |                |                                |                            |        |
|                      | BLM03BB121SN1D     | 120 $\pm$ 25%   | 120     | 100                | 1.5            | 1.6                            |                            |        |
|                      | BLM03BB121SN1B     |   |         |                    |                |                                |                            |        |
|                      | BLM03BC330SN1D     | 33 $\pm$ 25%  | 33      | 150                | 0.85           | 0.90                           |                            |        |
|                      | BLM03BC330SN1B     |   |         |                    |                |                                |                            |        |
|                      | BLM03BC560SN1D     | 56 $\pm$ 25%  | 56      | 100                | 1.05           | 1.10                           |                            |        |
|                      | BLM03BC560SN1B     |   |         |                    |                |                                |                            |        |
|                      | BLM03BC800SN1D     | 80 $\pm$ 25%  | 80      | 100                | 1.40           | 1.45                           |                            |        |
|                      | BLM03BC800SN1B     |   |         |                    |                |                                |                            |        |
|                      | BLM03BD750SN1D     | 75 $\pm$ 25%  | 75      | 300                | 0.4            | 0.5                            |                            |        |
|                      | BLM03BD750SN1B     |   |         |                    |                |                                |                            |        |
|                      | BLM03BD121SN1D     | 120 $\pm$ 25%   | 120     | 250                | 0.5            | 0.6                            |                            |        |
|                      | BLM03BD121SN1B     |   |         |                    |                |                                |                            |        |
|                      | BLM03BD241SN1D     | 240 $\pm$ 25%   | 240     | 200                | 0.8            | 0.9                            |                            |        |
|                      | BLM03BD241SN1B     |   |         |                    |                |                                |                            |        |
|                      | BLM03BD471SN1D     | 470 $\pm$ 25%   | 470     | 215                | 1.5            | 1.6                            |                            |        |
|                      | BLM03BD471SN1B     |   |         |                    |                |                                |                            |        |
|                      | BLM03BD601SN1D     | 600 $\pm$ 25%   | 600     | 200                | 1.7            | 1.8                            |                            |        |
|                      | BLM03BD601SN1B     |   |         |                    |                |                                |                            |        |
|                      | BLM03BX102SN1D     | 1000 $\pm$ 25%  | 1000    | 170                | 1.70           | 1.75                           |                            |        |
|                      | BLM03BX102SN1B     |   |         |                    |                |                                |                            |        |
|                      | BLM03BX182SN1D     | 1800 $\pm$ 25%  | 1800    | 140                | 2.50           | 2.55                           |                            |        |
|                      | BLM03BX182SN1B     |   |         |                    |                |                                |                            |        |

■ Operating Temperature : -55°C to +125°C
■ Storage Temperature : -55°C to +125°C

(Note) As for the Rated current marked with \*1, Rated Current is derated as right figure depending on the operating temperature.

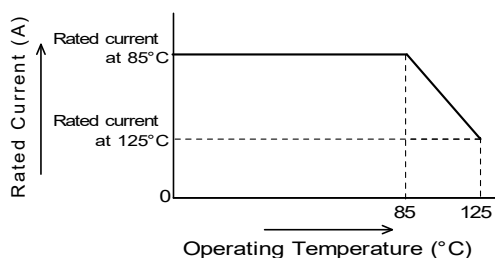

#### 4. Style and Dimensions

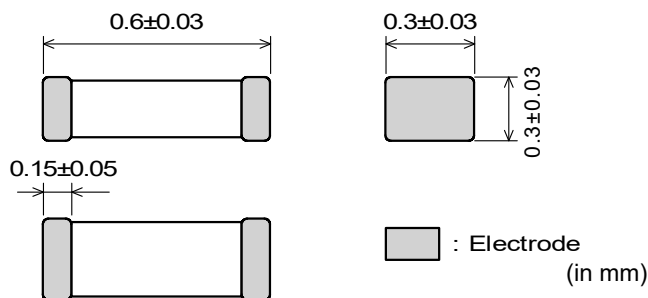

#### ■ Equivalent Circuit

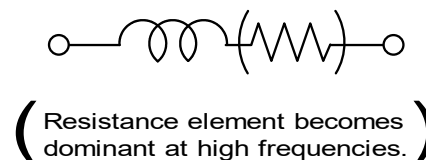

■ Unit Mass(Typical value)  
0.3mg

#### 5. Marking

No marking.

# Reference Only

Spec.No.JENF243A-0020AG-01

P3/9

## 6. Standard Testing Conditions

< Unless otherwise specified >

Temperature : Ordinary Temp. (15 °C to 35 °C )  
Humidity : Ordinary Humidity (25%(RH) to 85%(RH))

< In case of doubt >

Temperature : 20°C±2 °C  
Humidity : 60%(RH) to 70%(RH)  
Atmospheric pressure : 86kPa to 106kPa

## 7. Specifications

### 7-1. Electrical Performance

| No.   | Item          | Specification | Test Method   |
|-------|---------------|---------------|---|
| 7-1-1 | Impedance     | Meet item 3.  | Measuring Frequency : 100MHz±1MHz<br>Measuring Equipment : KEYSIGHT4291A or the equivalent<br>Test Fixture : KEYSIGHT16192A or the equivalent |
| 7-1-2 | DC Resistance | Meet item 3.  | Measuring Equipment : Digital multi meter<br>* Except resistance of the Substrate and Wire  |

### 7-2. Mechanical Performance

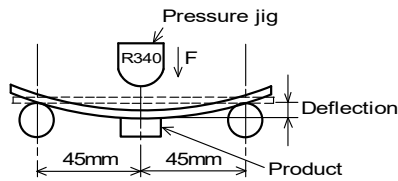
| No.                          | Item                         | Specification  | Test Method  |           |                              |             |               |              |   |
|------------------------------|------------------------------|--|--|-----------|------------------------------|-------------|---------------|--------------|---|
| 7-2-1                        | Appearance and Dimensions    | Meet item 4.   | Visual Inspection and measured with Measuring Microscope.  |           |                              |             |               |              |   |
| 7-2-2                        | Bending Strength             | Meet Table 1.<br><br><table border="1" style="margin-left: 20px;"> <caption>Table 1</caption> <tr> <td>Appearance</td> <td>No damage</td> </tr> <tr> <td>Impedance Change (at 100MHz)</td> <td>Within ±30%</td> </tr> <tr> <td>DC Resistance</td> <td>Meet item 3.</td> </tr> </table> | Appearance   | No damage | Impedance Change (at 100MHz) | Within ±30% | DC Resistance | Meet item 3. | It shall be soldered on the Glass-epoxy substrate.<br>Substrate : 100mm×40mm×0.8mm<br>Deflection : 1.0mm<br>Speed of Applying Force : 0.5mm/s<br>Keeping Time : 30s<br><br> |
| Appearance                   | No damage                    |  |  |           |                              |             |               |              |   |
| Impedance Change (at 100MHz) | Within ±30%                  |  |  |           |                              |             |               |              |   |
| DC Resistance                | Meet item 3.                 |  |  |           |                              |             |               |              |   |
| 7-2-3                        | Vibration                    |  | It shall be soldered on the substrate.<br>Oscillation Frequency : 10Hz to 55Hz to 10Hz for 1 min<br>Total Amplitude : 1.5mm<br>Testing Time : A period of 2 hours in each of 3 mutually perpendicular directions. (Total 6 h)          |           |                              |             |               |              |   |
| 7-2-4                        | Resistance to Soldering Heat |  | Pre-Heating : 150°C±10°C, 60s~90s<br>Solder : Sn-3.0Ag-0.5Cu<br>Solder Temperature : 270°C±5°C<br>Immersion Time : 10s±0.5s<br>Immersion and emersion rates : 25mm/s<br>Then measured after exposure in the room condition for 48h±4h. |           |                              |             |               |              |   |
| 7-2-5                        | Solderability                | The electrodes shall be at least 95% covered with new solder coating.  | Flux : Ethanol solution of rosin,25(wt)%<br>Pre-Heating : 150°C±10°C, 60s~90s<br>Solder : Sn-3.0Ag-0.5Cu<br>Solder Temperature : 240°C±5°C<br>Immersion Time : 3s±1s<br>Immersion and emersion rates : 25mm/s                          |           |                              |             |               |              |   |

### 7-3.Environmental Performance

It shall be soldered on the substrate.

| No.   | Item              | Specification | Test Method   |
|-------|-------------------|---------------|---|
| 7-3-1 | Temperature Cycle | Meet Table 1. | 1 cycle :<br>1 step : -55 °C(+0 °C,-3 °C) / 30min±3min<br>2 step : Ordinary temp. / 10min to 15min<br>3 step : +125 °C(+3 °C,-0 °C) / 30min±3min<br>4 step : Ordinary temp. / 10min to 15min<br>Total of 100 cycles<br>Then measured after exposure in the room condition for 48h±4h. |
| 7-3-2 | Humidity          |               | Temperature : 40°C±2°C<br>Humidity : 90%(RH) to 95%(RH)<br>Time : 1000h(+48h,-0h)<br>Then measured after exposure in the room condition for 48h±4h.   |
| 7-3-3 | Heat Life         |               | Temperature : 125°C±3°C<br>Applying Current : Rated Current (at 125°C)<br>Time : 1000h(+48h,-0h)<br>Then measured after exposure in the room condition for 48h±4h.  |
| 7-3-4 | Cold Resistance   |               | Temperature : -55±2°C<br>Time : 1000h(+48h,-0h)<br>Then measured after exposure in the room condition for 48h±4h.   |

### 8.Specification of Packaging

#### 8-1.Appearance and Dimensions (8mm-wide paper tape)

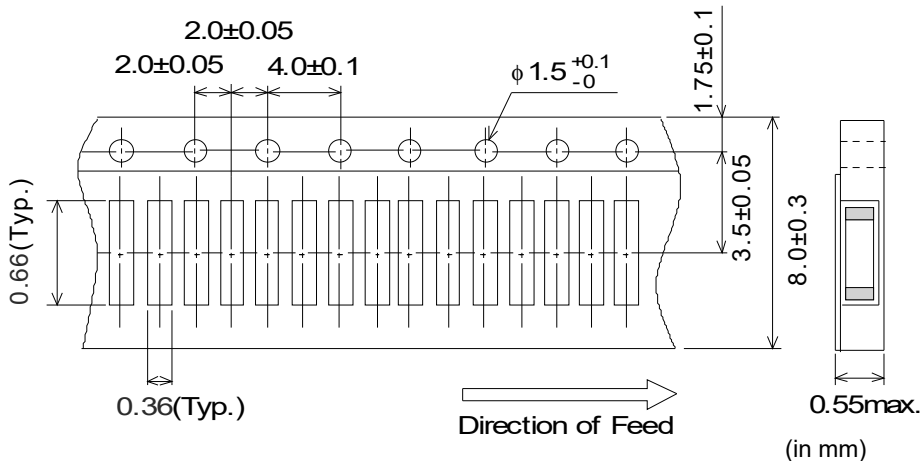

(1)Taping

Products shall be packaged in the cavity of the base tape of 8mm-wide, 2mm-pitch continuously and sealed by cover tape .

(2)Sprocket hole: The sprocket holes are to the right as the tape is pulled toward the user.

(3)Spliced point:The base tape and cover tape have no spliced point

(4)Cavity:There shall not be burr in the cavity.

(5)Missing components number

Missing components number within 0.025% of the number per reel or 1 pc., whichever is greater, and are not continuous. The specified quantity per reel is kept.

# Reference Only

## 8-2. Tape Strength

(1) Pull Strength

|            |         |
|------------|---------|
| Cover tape | 5N min. |
|------------|---------|

(2) Peeling off force of Cover tape  
 0.1N to 0.6N (Minimum value is typical.)  
 \*Speed of Peeling off: 300mm/min

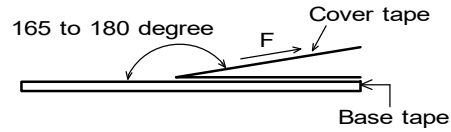

## 8-3. Taping Condition

(1) Standard quantity per reel

|                         |                   |
|-------------------------|-------------------|
| Quantity per 180mm reel | 15000 pcs. / reel |
|-------------------------|-------------------|

- (2) There shall be leader-tape (top tape and empty tape) and trailer-tape (empty tape) as follows.
- (3) On paper tape, the top tape and the base tape shall not be adhered at the tip of the empty leader tape for more than 5 pitch.
- (4) Marking for reel

The following items shall be marked on a label and the label is stuck on the reel.  
 (Customer part number, MURATA part number, Inspection number(\*1), RoHS marking(\*2), Quantity, etc)

\*1) « Expression of Inspection No. »      □□   OOOO   XXX  
   (1)        (2)        (3)

(1) Factory Code  
 (2) Date                      First digit                      : Year / Last digit of year  
   Second digit                      : Month / Jan. to Sep. → 1 to 9, Oct. to Dec. → O,N,D  
   Third, Fourth digit : Day

(3) Serial No.

\*2) « Expression of RoHS marking »      ROHS - Y (Δ)  
   (1) (2)

(1) RoHS regulation conformity parts.  
 (2) MURATA classification number

(5) Outside package

These reels shall be packed in the corrugated cardboard package and the following items shall be marked on a label and the label is stuck on the box.

(Customer name, Purchasing Order Number, Customer Part Number, MURATA part number, RoHS marking(\*2), Quantity, etc)

(6) Dimensions of reel and taping (leader-tape, trailer-tape)

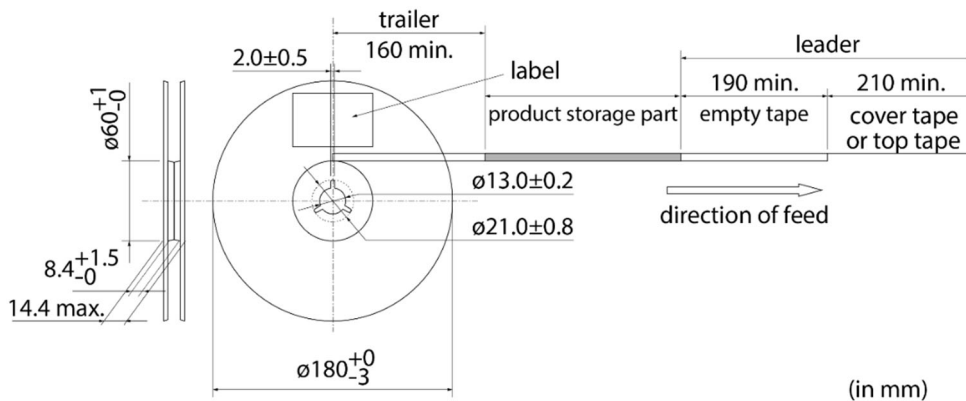

## 8-4. Specification of Outer Case

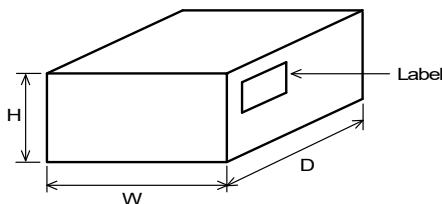

| Outer Case Dimensions (mm) |     |    | Standard Reel Quantity in Outer Case (Reel) |
|----------------------------|-----|----|---|
| W                          | D   | H  |   |
| 186                        | 186 | 93 | 5   |

\* Above Outer Case size is typical. It depends on a quantity of an order.

**9. ⚠ Caution**

**9-1. Surge current**

Excessive surge current (pulse current or rush current) than specified rated current applied to the product may cause a critical failure, such as an open circuit, burnout caused by excessive temperature rise.  
Please contact us in advance in case of applying the surge current.

**9-2. Limitation of Applications**

Please contact us before using our products for the applications listed below which require especially high reliability for the prevention of defects which might directly cause damage to the third party's life, body or property.

- |                                   |  |
|-----------------------------------|--|
| (1) Aircraft equipment            | (6) Disaster prevention / crime prevention equipment   |
| (2) Aerospace equipment           | (7) Traffic signal equipment   |
| (3) Undersea equipment            | (8) Transportation equipment (vehicles, trains, ships, etc.)   |
| (4) Power plant control equipment | (9) Data-processing equipment  |
| (5) Medical equipment             | (10) Applications of similar complexity and /or reliability requirements to the applications listed in the above |

**10. Notice**

Products can only be soldered with reflow.  
This product is designed for solder mounting.  
Please consult us in advance for applying other mounting method such as conductive adhesive.

**10-1. Land pattern designing**

- Standard land dimensions (Reflow soldering)

< For BLM03 series (except BLM03PG, BLM03PX, BLM03AX type) >

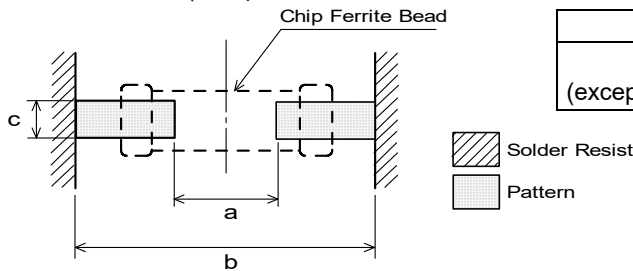

| Type                                | a    | b    | c    |
|-------------------------------------|------|------|------|
| BLM03<br>(except 03PG, PX, AX Type) | 0.25 | 0.80 | 0.30 |

(in mm)

< For BLM03PG, BLM03PX, BLM03AX type >

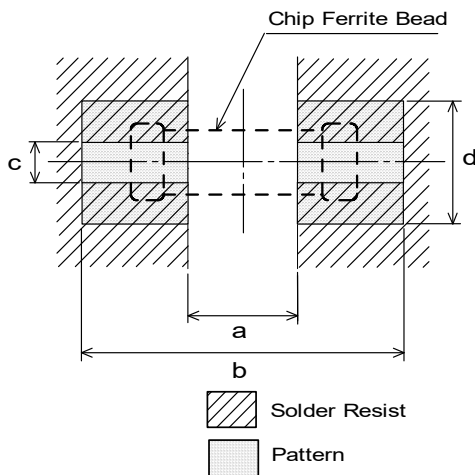

| Rated Current (A) | a    | b    | c    | Land pad thickness and dimension d |      |      |
|-------------------|------|------|------|------------------------------------|------|------|
|                   |      |      |      | 18μm                               | 35μm | 70μm |
| max.0.9           | 0.25 | 0.80 | 0.30 | 0.3                                | 0.3  | 0.3  |
| max.1.8           |      |      |      | 1.2                                | 0.7  | 0.3  |

(in mm)

\*The excessive heat by land pads may cause deterioration at joint of products with substrate.

## 10-2.Soldering Conditions

### (1) Flux,Solder

|        |  |
|--------|--|
| Flux   | Use rosin-based flux, but not highly acidic flux (with chlorine content exceeding 0.2(wt)%.)<br>Do not use water-soluble flux. |
| Solder | Use Sn-3.0Ag-0.5Cu solder<br>Standard thickness of solder paste : 100 μm to 150 μm   |

### (2) Soldering conditions

- Pre-heating should be in such a way that the temperature difference between solder and ferrite surface is limited to 150°C max. Also cooling into solvent after soldering should be in such a way that the temperature difference is limited to 100°C max.

Insufficient pre-heating may cause cracks on the ferrite, resulting in the deterioration of product quality.

- Standard soldering profile and the limit soldering profile is as follows.

The excessive limit soldering conditions may cause leaching of the electrode and / or resulting in the deterioration of product quality.

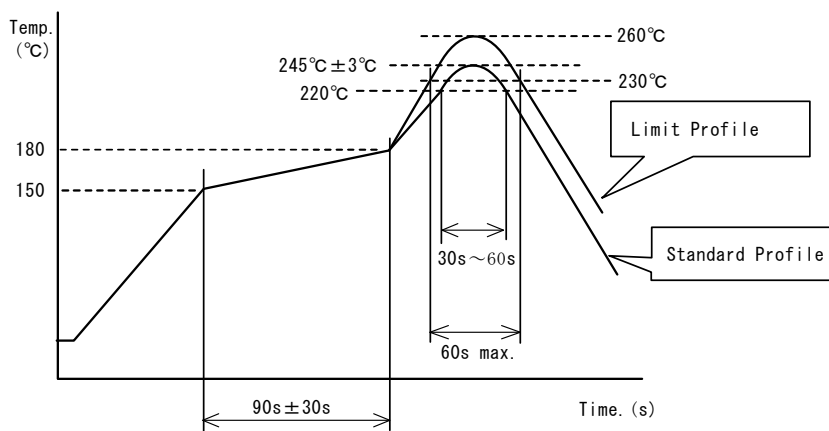

|                  | Standard Profile     | Limit Profile         |
|------------------|----------------------|-----------------------|
| Pre-heating      | 150~180°C 、 90s±30s  |                       |
| Heating          | above 220°C、 30s~60s | above 230°C、 60s max. |
| Peak temperature | 245±3°C              | 260°C,10s             |
| Cycle of reflow  | 2 times              | 2 times               |

## 10-3. Reworking with soldering iron

- Pre-heating: 150°C, 1 min
- Tip temperature: 350°C max.
- Soldering time : 3(+1,-0) seconds.
- Soldering iron output: 80W max.
- Tip diameter: φ 3mm max.
- Times : 2times max.

Note :Do not directly touch the products with the tip of the soldering iron in order to prevent the crack on the ferrite material due to the thermal shock.

## 10-4.Solder Volume

Solder shall be used not to be exceeded as shown below.

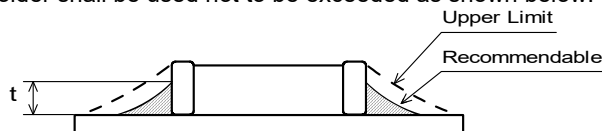

$$\frac{1}{3}T \leq t \leq T$$

(T:Chip thickness)

Accordingly increasing the solder volume, the mechanical stress to product is also increased. Exceeding solder volume may cause the failure of mechanical or electrical performance.

### 10-5.Attention regarding P.C.B. bending

The following shall be considered when designing and laying out P.C.B.'s.

- (1) P.C.B. shall be designed so that products are not subject to the mechanical stress for board warpage.  
 <Products direction>

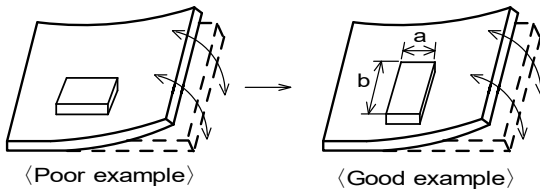

Products shall be located in the sideways direction (Length:a<b) to the mechanical stress.

- (2)Components location on P.C.B. separation.

It is effective to implement the following measures, to reduce stress in separating the board.

It is best to implement all of the following three measures; however, implement as many measures as possible to reduce stress.

| Contents of Measures   | Stress Level |
|--|--------------|
| (1) Turn the mounting direction of the component parallel to the board separation surface. | A > D *1     |
| (2) Add slits in the board separation part.  | A > B        |
| (3) Keep the mounting position of the component away from the board separation surface.    | A > C        |

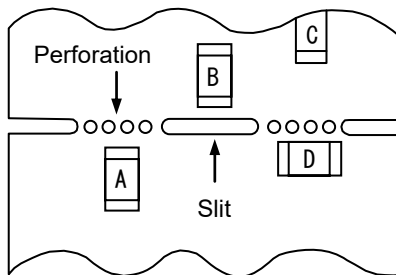

\*1 A > D is valid when stress is added vertically to the perforation as with Hand Separation.  
 If a Cutting Disc is used, stress will be diagonal to the PCB, therefore A > D is invalid.

- (3) Mounting Components Near Screw Holes

When a component is mounted near a screw hole, it may be affected by the board deflection that occurs during the tightening of the screw. Mount the component in a position as far away from the screw holes as possible.

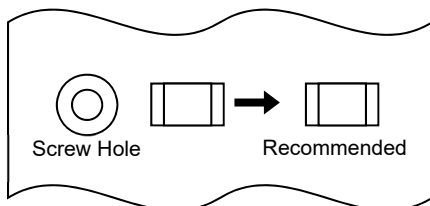

### 10-6.Mounting density

Add special attention to radiating heat of products when mounting the inductor near the products with heating.  
 The excessive heat by other products may cause deterioration at joint of this product with substrate.



## 10-7. Cleaning

When cleaning this product, observe the following conditions.

Any cleaning may cause deterioration in the quality of the product, so please check the quality of this product before use.

- (1) The cleaning temperature shall be 60°C max. If isopropyl alcohol (IPA) is used, the cleaning temperature shall be 40°C max.
  - (2) When ultrasonic cleaning is used, under some cleaning conditions, the substrate could resonate and the substrate vibrations could result in chip cracks, solder breakage, and other problems. Be sure to always perform a test cleaning beforehand using an actual cleaning device, and then check the quality of the products.
  - (3) Cleaner  
Alcohol-based cleaner: IPA  
Aqueous agent: PINE ALPHA ST-100S
  - (4) There shall be no residual flux or residual cleaner.  
When using aqueous agent, rinse the product with deionized water adequately and completely dry it so that no cleaner is left.
- \* For other cleaning, please consult our technical department.

## 10-8. Operating Environment

Do not use this product under the following environmental conditions, on deterioration of the Insulation Resistance of the Ferrite material and/or corrosion of Inner Electrode may result from the use.

- (1) in the corrodible atmosphere such as acidic gases, alkaline gases, chlorine, sulfur gases, organic gases and etc.  
(the sea breeze, Cl<sub>2</sub>, H<sub>2</sub>S, NH<sub>3</sub>, SO<sub>2</sub>, NO<sub>2</sub>, etc)
- (2) in the atmosphere where liquid such as organic solvent, may splash on the products.
- (3) in the atmosphere where the temperature / humidity changes rapidly and it is easy to dew.

## 10-9. Resin coating

The impedance value may change and/or it may affect on the product's performance due to high cure-stress of resin to be used for coating / molding products. So please pay your careful attention when you select resin. In prior to use, please make the reliability evaluation with the product mounted in your application set.

## 10-10. Handling of a substrate

After mounting products on a substrate, do not apply any stress to the product caused by bending or twisting to the substrate when cropping the substrate, inserting and removing a connector from the substrate or tightening screw to the substrate.

Excessive mechanical stress may cause cracking in the product.

Bending

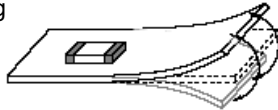

Twisting

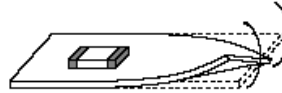

## 10-11. Storage Conditions

### (1) Storage period

Use the products within 6 months after delivered.

Solderability should be checked if this period is exceeded.

### (2) Storage conditions

- Products should be stored in the warehouse on the following conditions.

Temperature : -10°C to 40°C

Humidity : 15% to 85% relative humidity

No rapid change on temperature and humidity

- Don't keep products in corrosive gases such as sulfur, chlorine gas or acid, or it may cause oxidization of electrode, resulting in poor solderability.
- Products should be stored on the palette for the prevention of the influence from humidity, dust and so on.
- Products should be stored in the warehouse without heat shock, vibration, direct sunlight and so on.
- Avoid storing the product by itself bare (i.e. exposed directly to air).

### (3) Delivery

Care should be taken when transporting or handling product to avoid excessive vibration or mechanical shock.

## 11. Note

- (1) Please make sure that your product has been evaluated in view of your specifications with our product being mounted to your product.
- (2) You are requested not to use our product deviating from the reference specifications.
- (3) The contents of this reference specification are subject to change without advance notice. Please approve our product specifications or transact the approval sheet for product specifications before ordering.

# Mouser Electronics

Authorized Distributor

Click to View Pricing, Inventory, Delivery & Lifecycle Information:

## Murata:

[BLM03AG121SN1D](#) [BLM03AG601SN1D](#) [BLM03AG102SN1D](#) [BLM03AG800SN1D](#) [BLM03BD121SN1D](#)  
[BLM03BD241SN1D](#) [BLM03BD750SN1D](#) [BLM03PG220SN1D](#) [BLM03AX100SN1D](#) [BLM03AX102SN1D](#)  
[BLM03AX121SN1D](#) [BLM03AX241SN1D](#) [BLM03AX601SN1D](#) [BLM03AX800SN1D](#) [BLM03BB220SN1D](#)  
[BLM03BB100SN1D](#) [BLM03AG700SN1D](#) [BLM03AG100SN1D](#) [BLM03BB470SN1D](#) [BLM03BB121SN1D](#)  
[BLM03AG241SN1D](#) [BLM03BB750SN1D](#) [BLM03BC330SN1D](#) [BLM03HD102SN1D](#) [BLM03HD331SN1D](#)  
[BLM03HD471SN1D](#) [BLM03HD601SN1D](#) [BLM03BC560SN1D](#) [BLM03BC800SN1D](#) [BLM03PG330SN1D](#)  
[BLM03BD471SN1D](#) [BLM03BD601SN1D](#) [BLM03HG102SN1D](#) [BLM03HG601SN1D](#) [BLM03EB250SN1D](#)  
[BLM03EB500SN1D](#) [BLM03HB191SN1D](#) [BLM03HG122SN1D](#) [BLM03PX330SN1D](#) [BLM03PX800SN1D](#)  
[BLM03PX220SN1D](#) [BLM03BX102SN1D](#) [BLM03BX182SN1D](#) [BLM03EB250SN1B](#) [BLM03PX121SN1D](#)  
[BLM03HB401SN1D](#)