

PCMFxUSB3BA/C series

Common-mode EMI filter for differential channels with integrated bidirectional ESD protection

Rev. 4 — 12 May 2020

Product data sheet

1. General description

Common-mode ElectroMagnetic Interference (EMI) filters with integrated bidirectional ElectroStatic Discharge (ESD) protection for one, two and three differential channels. The devices are designed to provide low insertion loss for differential high-speed signals on each channel while unwanted common-mode signals are attenuated.

Each differential channel incorporates two signal lines that are coupled by integrated coils. Diodes provide protection to downstream components from ESD voltages up to ± 15 kV on each signal line.

Table 1. Product overview

Type number	Number of channels	Package Name
PCMF1USB3BA/C	1	WLCSP5
PCMF2USB3BA/C	2	WLCSP10
PCMF3USB3BA/C	3	WLCSP15

2. Features and benefits

- One, two and three differential channels common-mode EMI filters with integrated ESD protection
- ESD protection up to ± 15 kV contact discharge according to IEC 61000-4-2
- Superior common-mode suppression over a wide frequency range
- Superior RF performance compared to other integrated filters or discrete filters with external ESD protection
- Extremely high symmetry between line pairs
- Industry-standard Wafer-Level Chip-Scale Packages: WLCSP5, 10 and 15 for smaller footprint

3. Applications

- Smartphone, cellular and cordless phone
- USB3.2, USB2.0, HDMI2.1, HDMI2.0, HDMI1.4
- General-purpose downstream ESD protection for differential data lines
- Tablet PC and Mobile Internet Device (MID)
- MIPI M-PHY and D-PHY as used in Camera Serial Interface (CSI) and Display Serial Interface (DSI)

4. Pinning information

Table 2. Pinning

Pin	Symbol	Description	Simplified outline	Graphic symbol
PCMF1USB3BA/C (WLCSP5_2-1-2)				
A1	CH1_IN+	channel 1+, external	<p>Transparent top view WLCSP5_2-1-2</p>	<p>aaa-028492</p>
A2	CH1_IN-	channel 1-, external		
B1	GND_CH1	ground channel 1		
C1	CH1_OUT+	channel 1+, internal		
C2	CH1_OUT-	channel 1-, internal		
PCMF2USB3BA/C (WLCSP10_4-2-4)				
A1	CH1_IN+	channel 1+, external	<p>Transparent top view WLCSP10_4-2-4</p>	<p>B1, B2 - no internal connection aaa-028493</p>
A2	CH1_IN-	channel 1-, external		
A3	CH2_IN+	channel 2+, external		
A4	CH2_IN-	channel 2-, external		
B1	GND_CH1	ground channel 1		
B2	GND_CH2	ground channel 2		
C1	CH1_OUT+	channel 1+, internal		
C2	CH1_OUT-	channel 1-, internal		
C3	CH2_OUT+	channel 2+, internal		
C4	CH2_OUT-	channel 2-, internal		
PCMF3USB3BA/C (WLCSP15_6-3-6)				
A1	CH1_IN+	channel 1+, external	<p>Transparent top view WLCSP15_6-3-6</p>	<p>B1, B2, B3 - no internal connection aaa-028494</p>
A2	CH1_IN-	channel 1-, external		
A3	CH2_IN+	channel 2+, external		
A4	CH2_IN-	channel 2-, external		
A5	CH3_IN+	channel 3+, external		
A6	CH3_IN-	channel 3-, external		
B1	GND_CH1	ground channel 1		
B2	GND_CH2	ground channel 2		
B3	GND_CH3	ground channel 3		
C1	CH1_OUT+	channel 1+, internal		
C2	CH1_OUT-	channel 1-, internal		
C3	CH2_OUT+	channel 2+, internal		
C4	CH2_OUT-	channel 2-, internal		
C5	CH3_OUT+	channel 3+, internal		
C6	CH3_OUT-	channel 3-, internal		

5. Ordering information

Table 3. Ordering information

Type number	Package	
	Name	Description
PCMF1USB3BA/C	WLCSP5	wafer level chip-size package; 5 bumps (2-1-2)
PCMF2USB3BA/C	WLCSP10	wafer level chip-size package; 10 bumps (4-2-4)
PCMF3USB3BA/C	WLCSP15	wafer level chip-size package; 15 bumps (6-3-6)

6. Marking

Table 4. Marking codes

Type number	Marking code
PCMF1USB3BA/C	PF1A
PCMF2USB3BA/C	PF2A
PCMF3USB3BA/C	PF3A

7. Limiting values

Table 5. Limiting values

In accordance with the Absolute Maximum Rating System (IEC 60134).

Symbol	Parameter	Conditions	Min	Max	Unit
V_I	input voltage		-4	4	V
V_{ESD}	electrostatic discharge voltage	IEC 61000-4-2, level 4; all input pins to ground			
		• contact discharge	-15	15	kV
		• air discharge	-15	15	kV
		IEC 61000-4-2, level 4; all output pins to ground			
		• contact discharge	-2	2	kV
		• air discharge	-2	2	kV
I_{PPM}	rated peak-pulse current	$t_p = 8/20 \mu s$	-7.5	7.5	A
T_{stg}	storage temperature		-40	+125	°C
T_{amb}	ambient temperature		-40	+125	°C

8. Characteristics

8.1. Channel characteristics

Table 6. Channel characteristics

$T_{amb} = 25\text{ °C}$ unless otherwise specified.

Symbol	parameter	Conditions		Min	Typ	Max	Unit
$R_{S(ch)}$	channel series resistance	single line; input to output		-	2.2	-	Ω
C_d	diode capacitance	$f = 1\text{ MHz}$; $V_I = 2.5\text{ V}$	[1]	-	0.3	-	pF
I_{RM}	reverse leakage current	per line; $V_I = 4\text{ V}$		-	1	100	nA
V_{BR}	breakdown voltage	$I_R = 1\text{ mA}$		6	9	-	V
R_{dyn}	dynamic resistance	TLP; positive transient	[2]	-	0.29	-	Ω
		TLP; negative transient	[2]	-	0.29	-	Ω

[1] This parameter is guaranteed by design

[2] 100 ns Transmission Line Pulse (TLP); 50 Ω ; pulser at 70 ns to 90 ns.

8.2. Frequency characteristics

Table 7. Frequency characteristics

$T_{amb} = 25\text{ °C}$ unless otherwise specified.

Symbol	Parameter	Conditions		Min	Typ	Max	Unit
Differential mode: S_{dd21}							
f_{-3dB}	cut-off frequency		[1]	-	10	-	GHz

[1] Normalized to attenuation at 1 MHz.

Common-mode EMI filter for differential channels with integrated bidirectional ESD protection

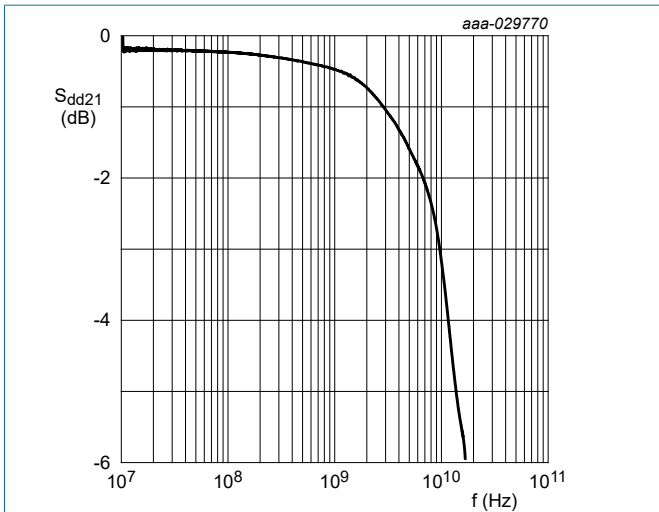

Fig. 1. Differential mode insertion loss; typical values

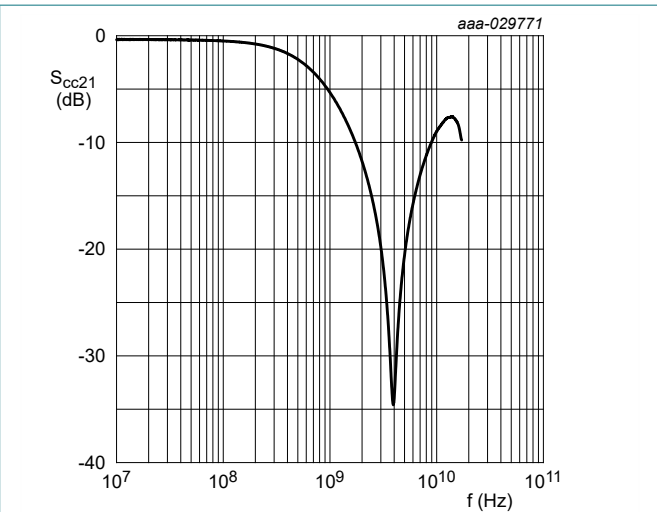
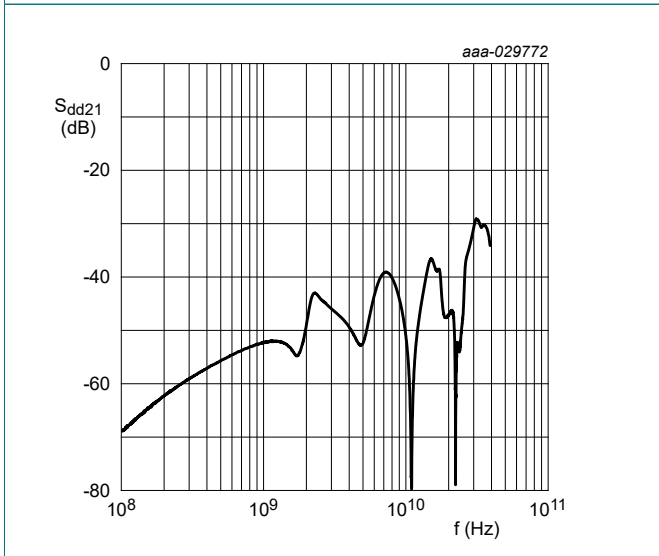
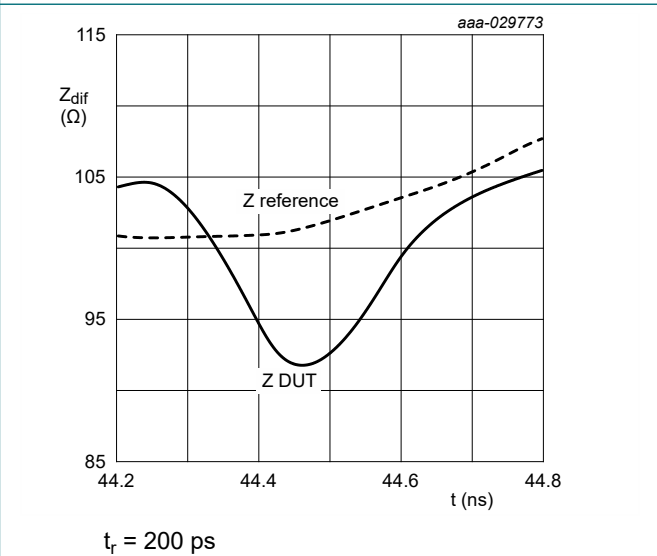

Fig. 2. Common-mode insertion loss; typical values



CH1 to CH2

Fig. 3. Differential crosstalk; typical values



$t_r = 200$ ps

Fig. 4. Differential Time Domain Reflectometer (TDR) plot; typical values

Common-mode EMI filter for differential channels with integrated bidirectional ESD protection

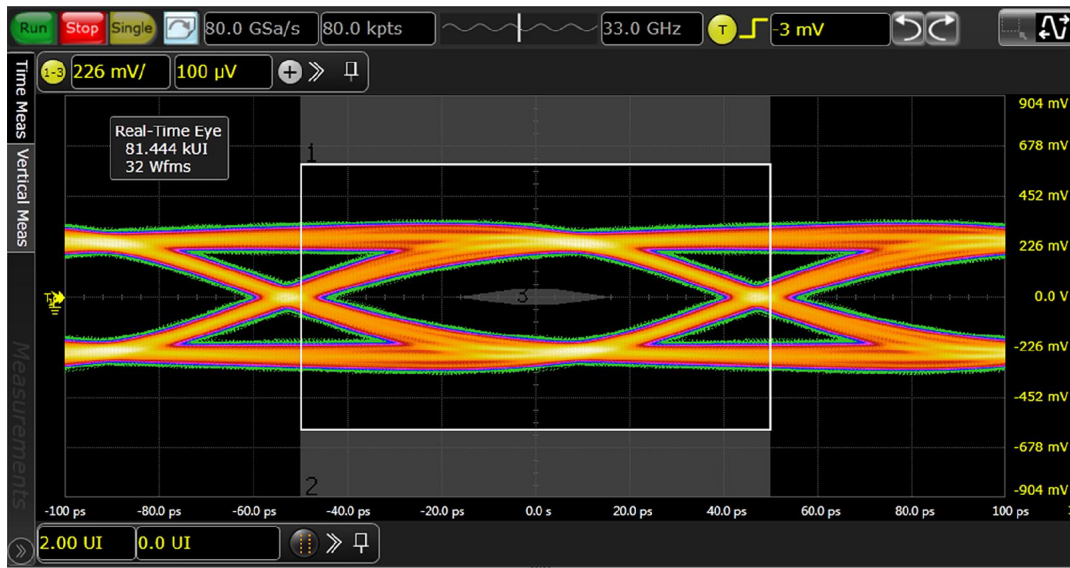

aaa-031490

Fig. 5. USB3.2 eye diagram 10 Gbps, PCB with device; typical values

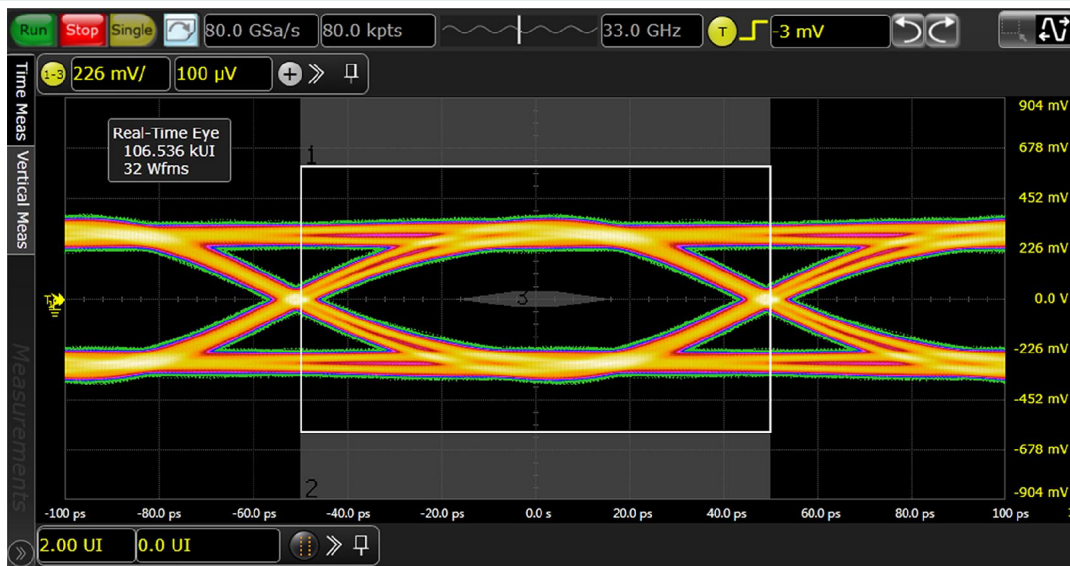

aaa-031491

Fig. 6. USB3.2 eye diagram 10 Gbps, PCB without device; typical values

Common-mode EMI filter for differential channels with integrated bidirectional ESD protection

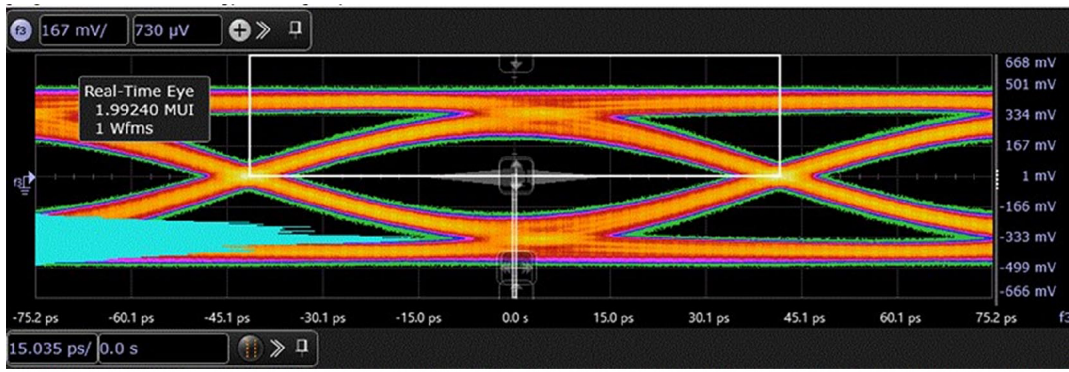

aaa-031492

Short cable model (SCM), no equalizer

Fig. 7. HDMI 2.1 12G FRL eye diagram, PCB with device; typical values

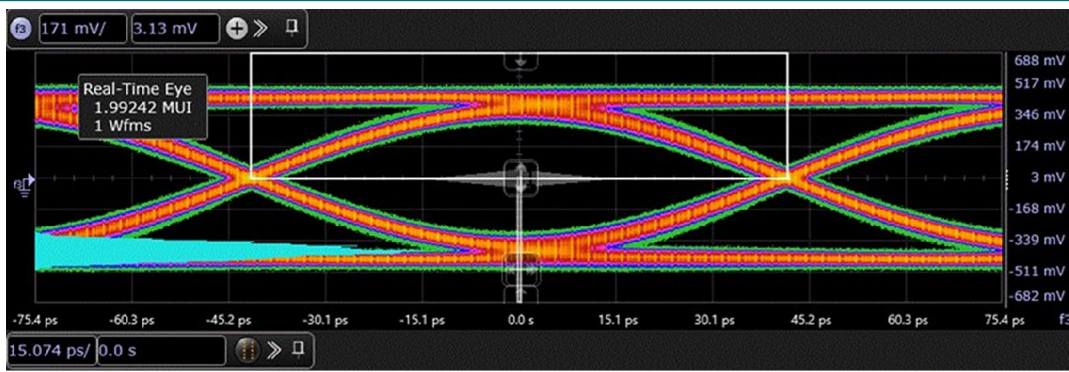

aaa-031493

Short cable model (SCM), no equalizer

Fig. 8. HDMI 2.1 12G FRL eye diagram, PCB without device; typical values

Common-mode EMI filter for differential channels with integrated bidirectional ESD protection

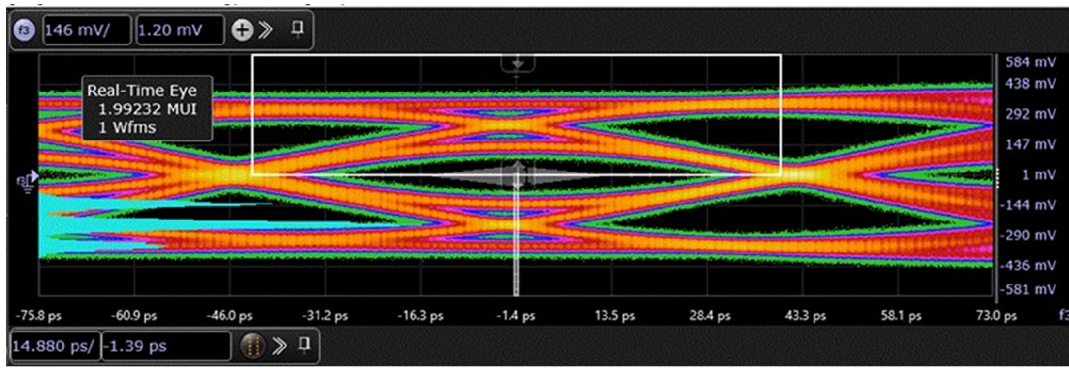

Worst cable model measured with CTLE gain setting 8 dB

Fig. 9. HDMI 2.1 12G FRL eye diagram, PCB with device; typical values

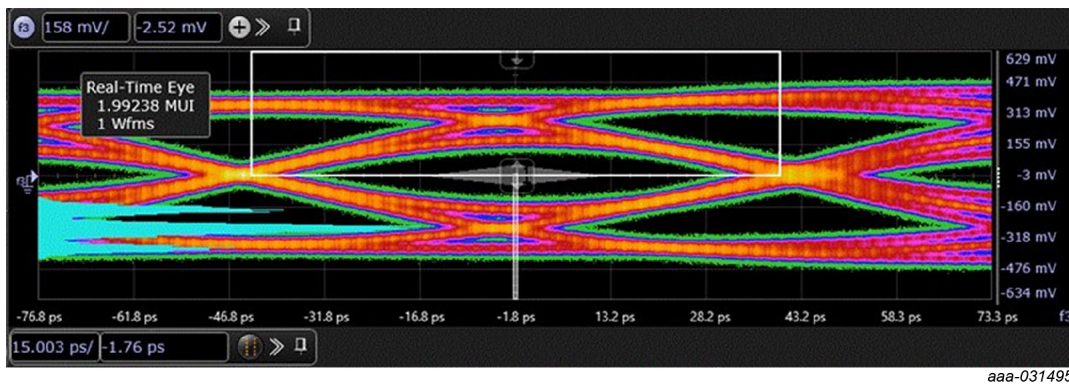

Worst cable model measured with CTLE gain setting 8 dB

Fig. 10. HDMI 2.1 12G FRL eye diagram, PCB without device; typical values

Common-mode EMI filter for differential channels with integrated bidirectional ESD protection



aaa-031496

Worst cable model, no equalizer

Fig. 11. HDMI 2.1 6 Gbps TMDS eye diagram, PCB with device; typical values



aaa-031497

Worst cable model, no equalizer

Fig. 12. HDMI 2.1 6 Gbps TMDS eye diagram, PCB without device; typical values

Common-mode EMI filter for differential channels with integrated bidirectional ESD protection

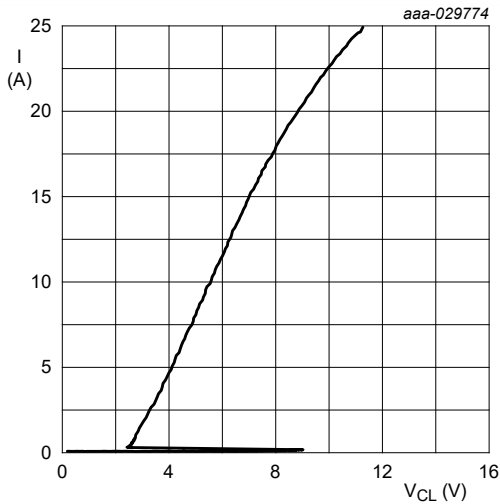

Transmission Line Pulse (TLP) = 100 ns;
measured CH_IN to GND

Fig. 13. Dynamic resistance with positive clamping; typical values

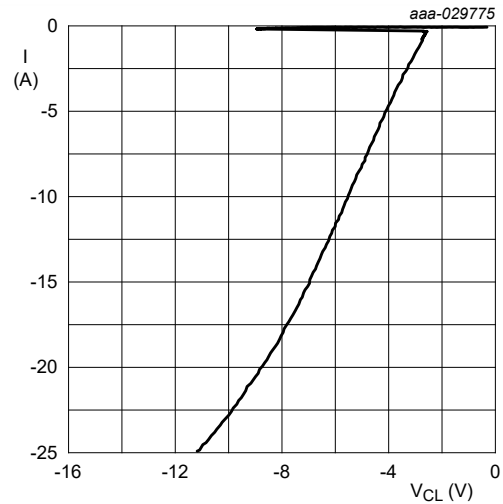

Transmission Line Pulse (TLP) = 100 ns;
measured CH_IN to GND

Fig. 14. Dynamic resistance with negative clamping; typical values

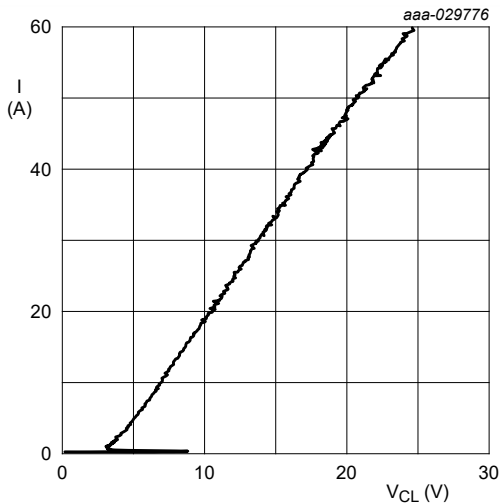

Very-Fast Transmission Line Pulse
(VF-TLP) = 5 ns;
measured CH_IN to GND

Fig. 15. Dynamic resistance with positive clamping; typical values

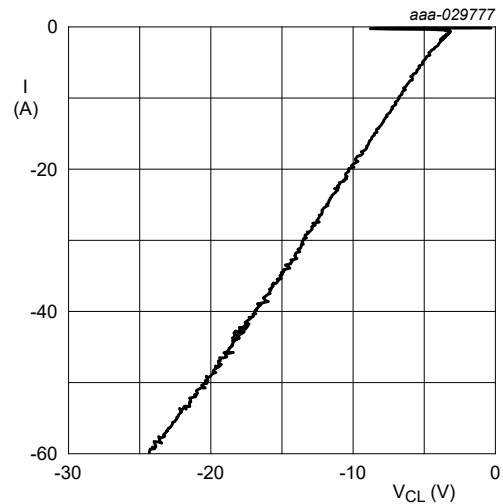

Very-Fast Transmission Line Pulse
(VF-TLP) = 5 ns;
measured CH_IN to GND

Fig. 16. Dynamic resistance with negative clamping; typical values

The device uses an advanced clamping structure showing a negative dynamic resistance. This snap-back behavior strongly reduces the clamping voltage to the system behind the ESD protection during an ESD event. Do not connect unlimited DC current sources to the data lines to avoid keeping the ESD protection device in snap-back state after exceeding breakdown voltage (due to an ESD pulse for instance).

Common-mode EMI filter for differential channels with integrated bidirectional ESD protection

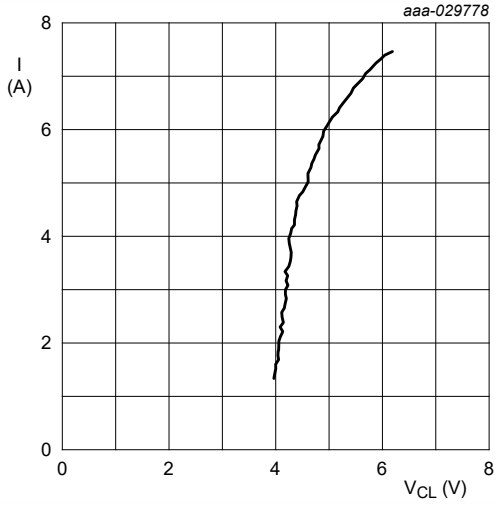

IEC61000-4-5; t_p = 8/20 μs; positive pulse

Fig. 17. Dynamic resistance with positive clamping; typical values

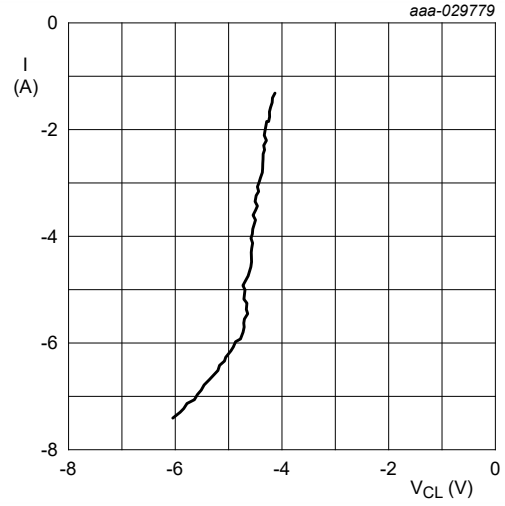

IEC61000-4-5; t_p = 8/20 μs; negative pulse

Fig. 18. Dynamic resistance with negative clamping; typical values

9. Application information

The device is designed to provide high-level ESD protection for differential high-speed data line pairs such as:

- USB 3.2
- HDMI 2.0
- Transition-Minimized Differential Signaling (TMDS)
- DisplayPort
- external Serial Advanced Technology Attachment (eSATA)
- Low Voltage Differential Signaling (LVDS)

When designing the Printed-Circuit Board (PCB), give careful consideration to impedance matching and signal coupling. Do not connect the protected signal lines to unlimited current sources like, for example, a battery.

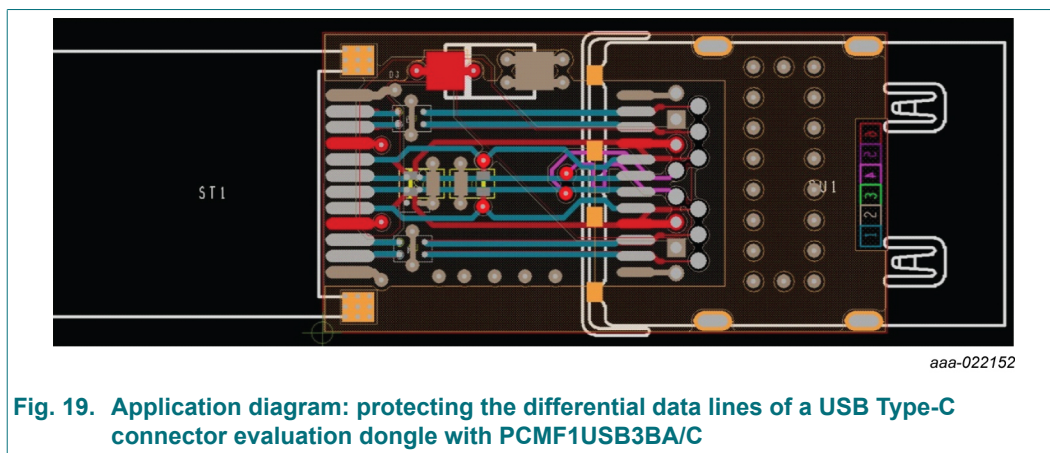

Fig. 19. Application diagram: protecting the differential data lines of a USB Type-C connector evaluation dongle with PCMF1USB3BA/C

Since the SuperSpeed TX/RX lines are separated by GND or VBUS from the Hi-Speed lines, PCMF1USB3BA/C makes it easy to achieve same signal lengths, straight routing, and optimal positioning for ESD protection directly at the connector.

10. Package outline

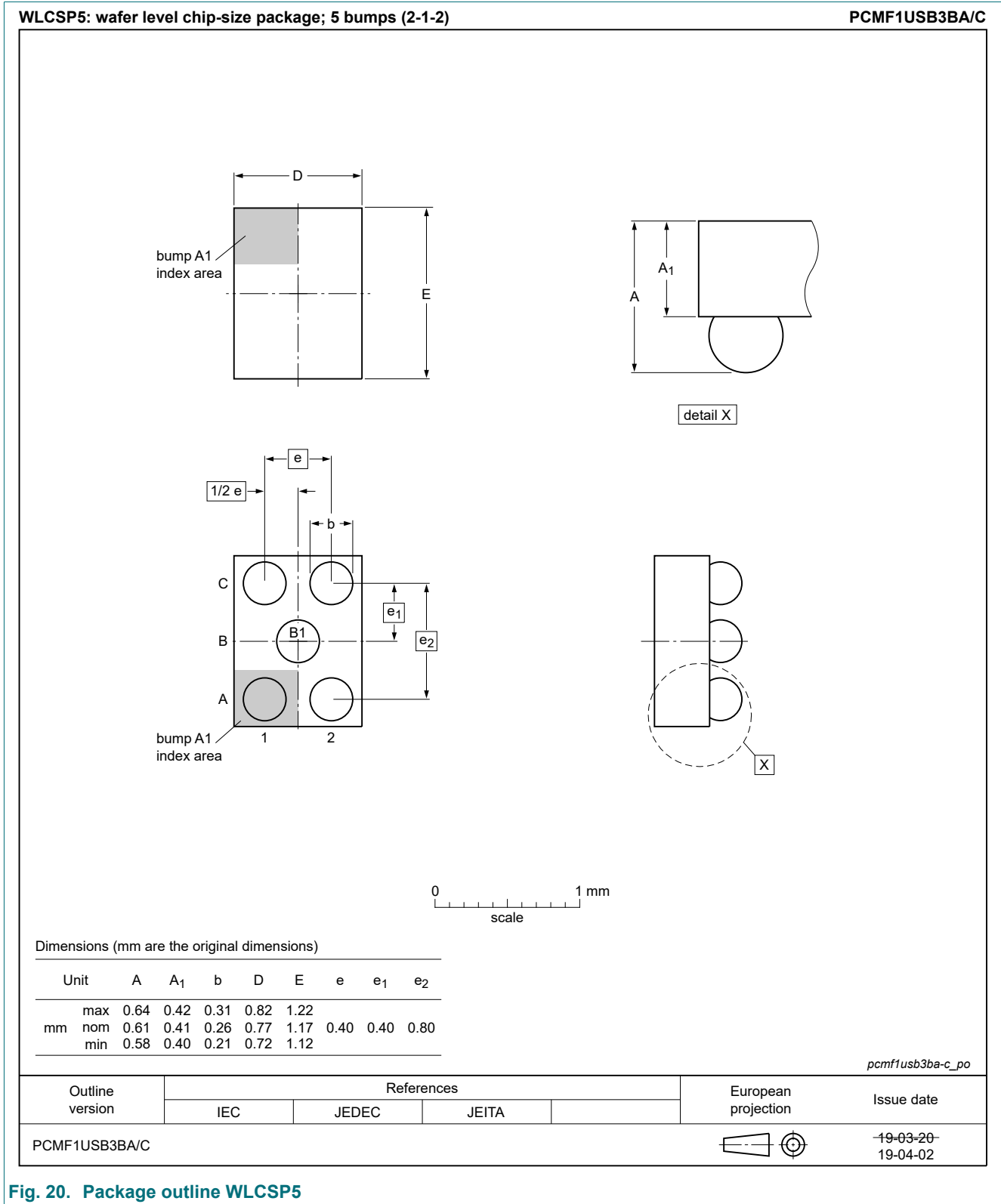

Fig. 20. Package outline WLCSP5

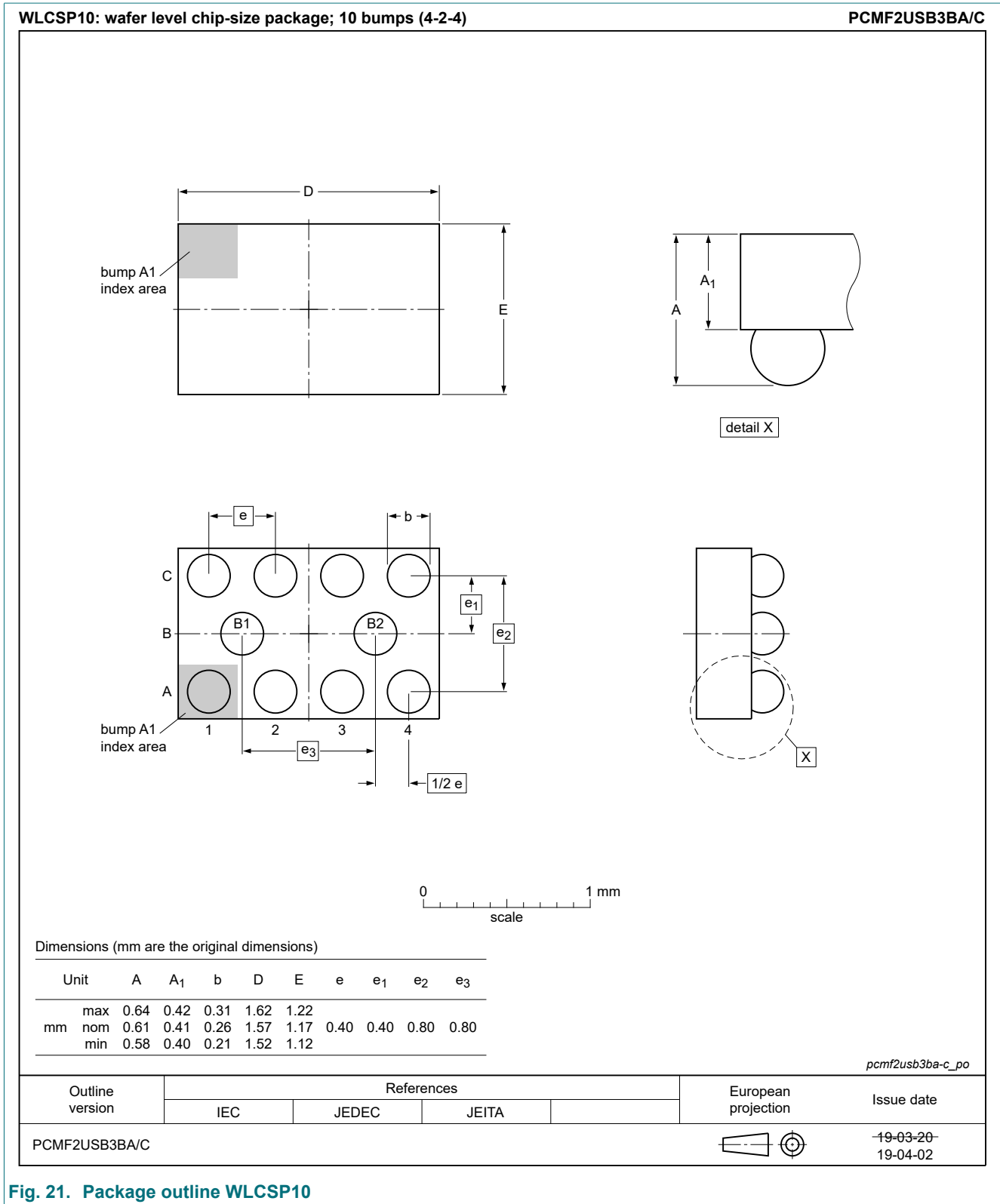

Fig. 21. Package outline WLCSP10

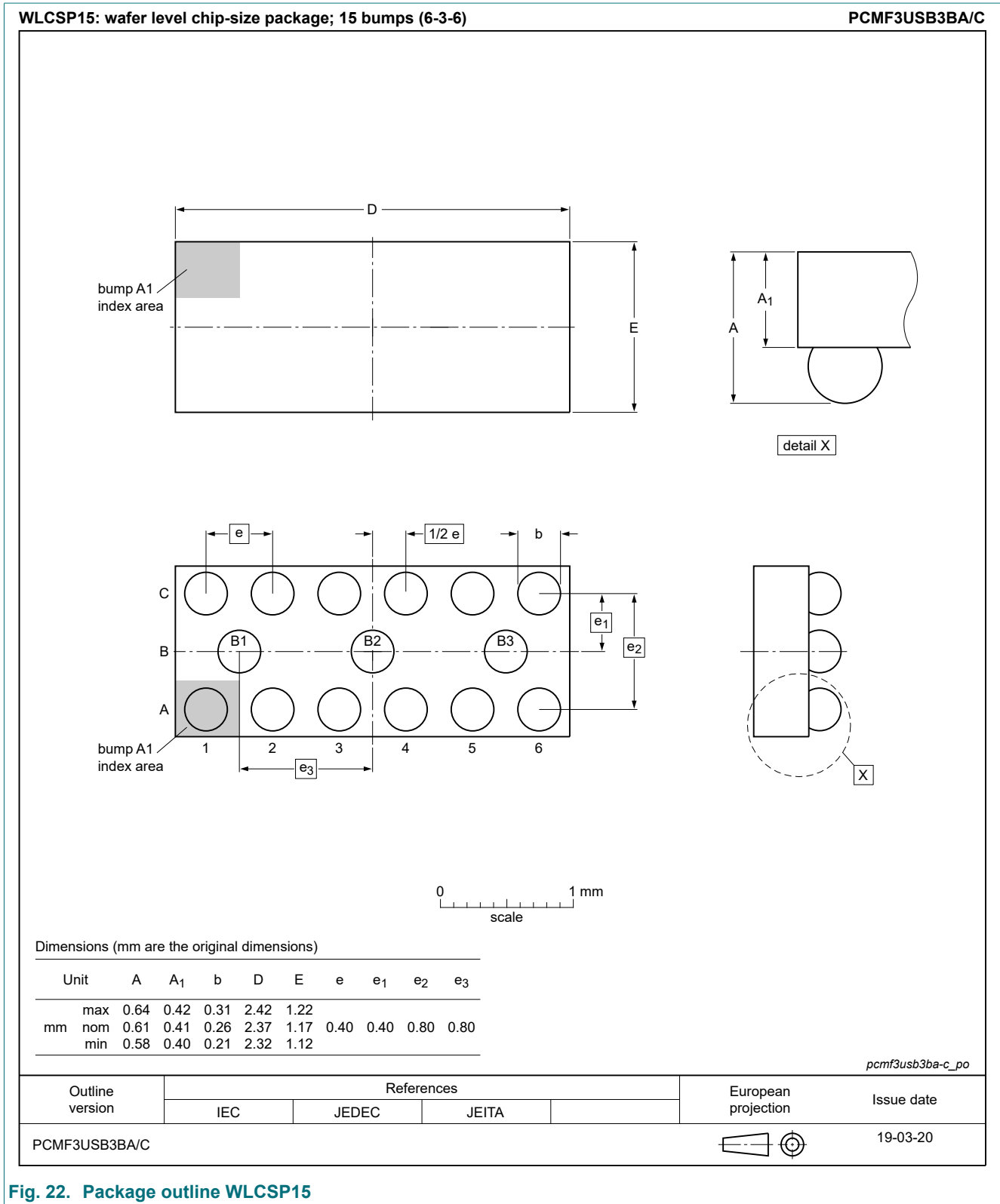

Fig. 22. Package outline WLCSP15

11. Soldering

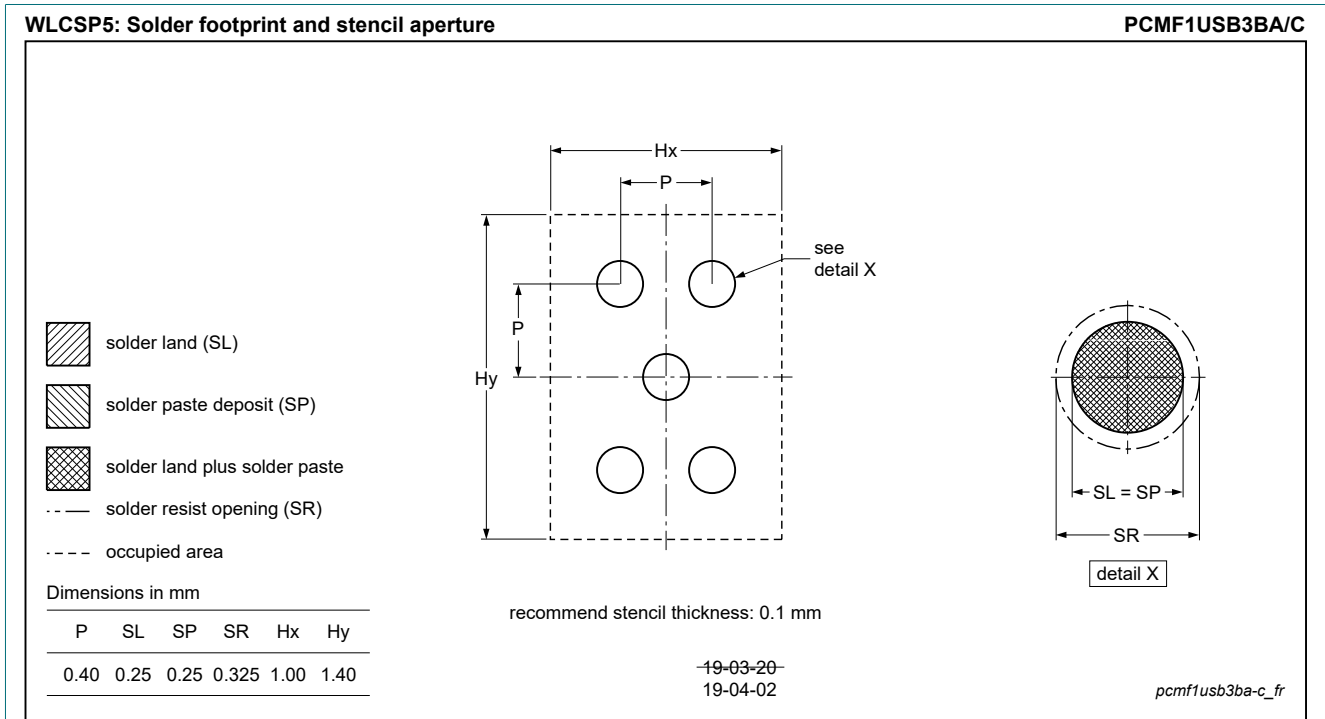

Fig. 23. Soldering footprint WLCSP5 (PCMF1USB3BA/C)

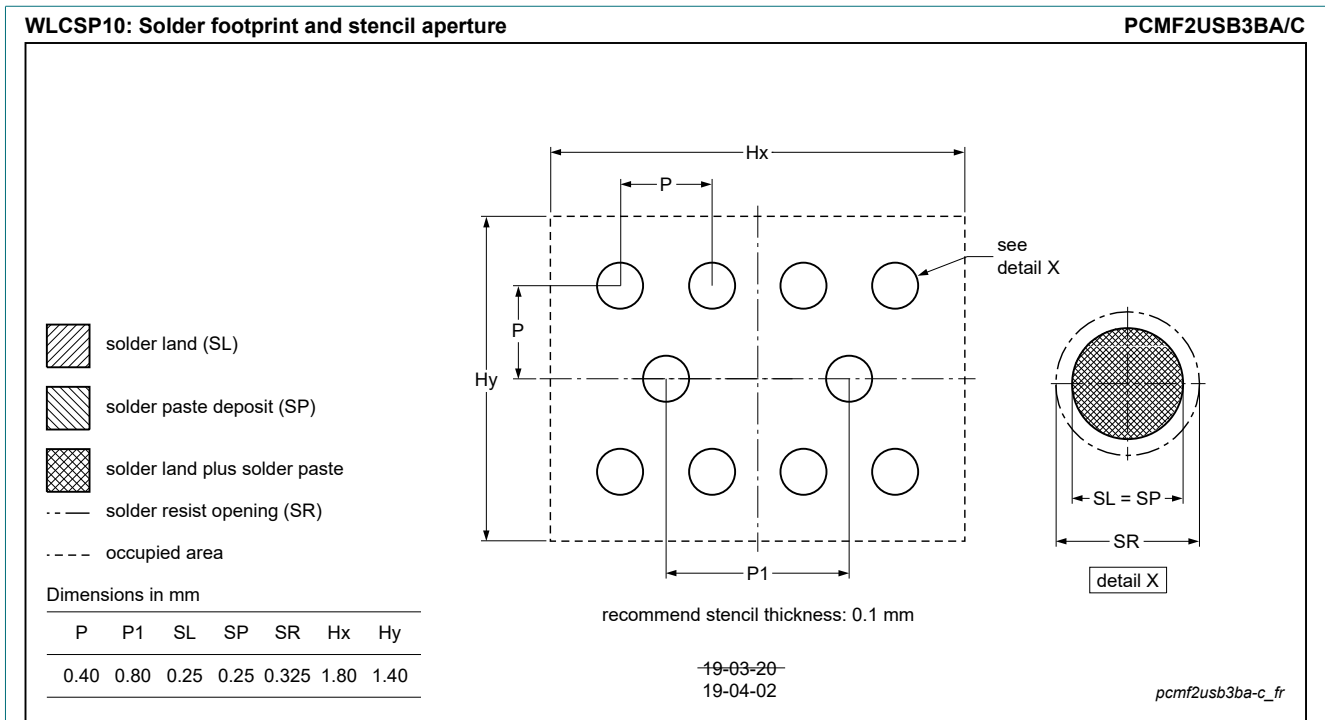

Fig. 24. Soldering footprint WLCSP10 (PCMF2USB3BA/C)

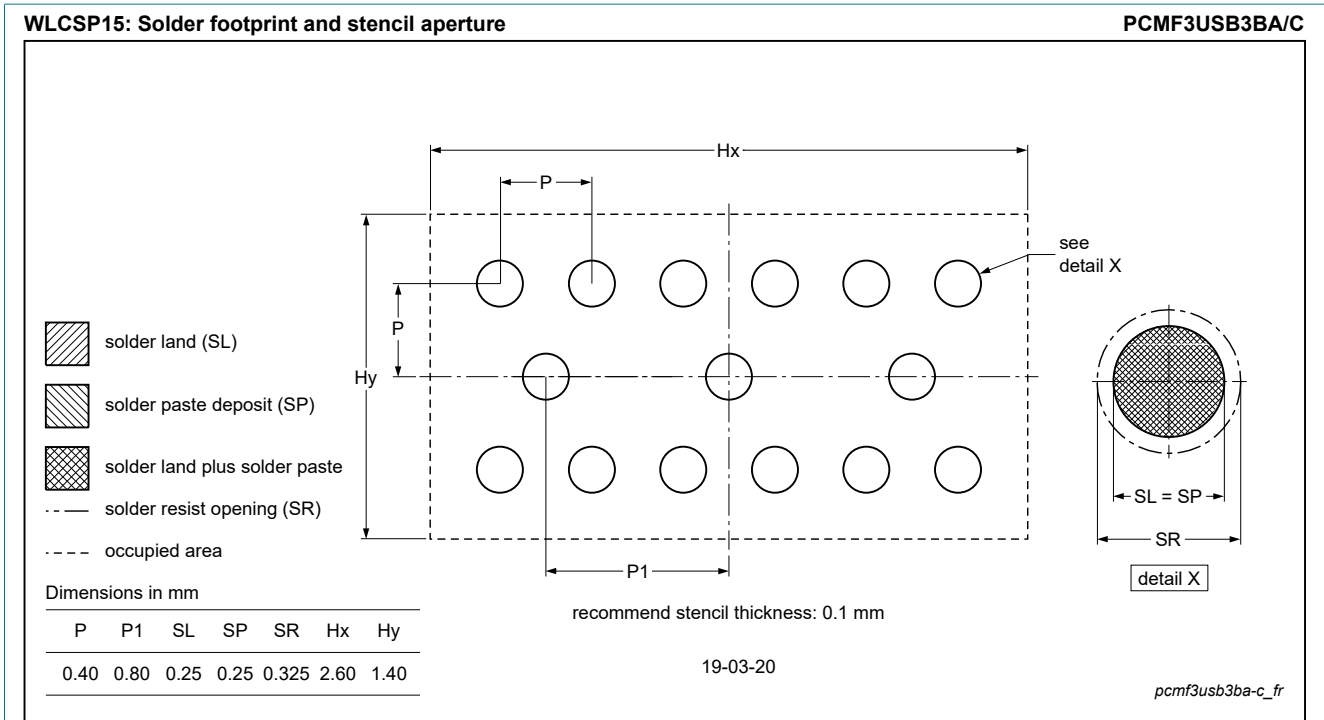

Fig. 25. Soldering footprint WLCSP15 (PCMF3USB3BA/C)

12. Revision history

Table 8. Revision history

Document ID	Release date	Data sheet status	Change notice	Supersedes
PCMFxUSB3BA_C_SER v.4	20200512	Product data sheet	-	PCMFxUSB3BA_C_SER v.3
Modifications:	<ul style="list-style-type: none"> Figure 5 to 12 added 			
PCMFxUSB3BA_C_SER v.3	20191125	Product data sheet	-	PCMFxUSB3BA_C_SER v.2
PCMFxUSB3BA_C_SER v.2	20190814	Product data sheet	-	PCMFxUSB3BA_C_SER v.1
PCMFxUSB3BA_C_SER v.1	20190408	Objective data sheet	-	-

Contents

1. General description	1
2. Features and benefits	1
3. Applications	1
4. Pinning information	2
5. Ordering information	3
6. Marking	3
7. Limiting values	3
8. Characteristics	4
8.1. Channel characteristics.....	4
8.2. Frequency characteristics.....	4
9. Application information	12
10. Package outline	13
11. Soldering	16
12. Revision history	18

© Nexperia B.V. 2020. All rights reserved

For more information, please visit: <http://www.nexperia.com>

For sales office addresses, please send an email to: salesaddresses@nexperia.com

Date of release: 12 May 2020

Mouser Electronics

Authorized Distributor

Click to View Pricing, Inventory, Delivery & Lifecycle Information:

[Nexperia:](#)

[PCMF1USB3BA/CZ](#) [PCMF3USB3BA/CZ](#) [PCMF2USB3BA/CZ](#)