



Operation Manual

Direct Operated 3-port solenoid valve

PRODUCT NAME

Series: VT/O 307

*(Model number: VT/O 307-***1-**)*

MODEL/ Series

* Body colour: White

SMC Corporation

Contents

Safety Instructions	2,3
Precautions on Design / Selection	4,5
Mounting	5
Piping	5
Wiring	5
Lubrication	5
Air Supply	5,6
Operating Environment	6
Maintenance	6
Specific Product Precautions	7,8
Troubleshooting	9
Remedy	10



Safety Instructions

These safety instructions are intended to prevent hazardous situations and/or equipment damage. These instructions indicate the level of potential hazard with the labels of “Caution,” “Warning” or “Danger.”

They are all important notes for safety and must be followed in addition to International Standards (ISO/IEC)*1), and other safety regulations.

*1) ISO 4414: Pneumatic fluid power -- General rules relating to systems

ISO 4413: Hydraulic fluid power -- General rules relating to systems

IEC 60204-1: Safety of machinery -- Electrical equipment of machines (Part 1: General requirements)

ISO 10218-1992: Manipulating industrial robots -Safety.

etc.



Caution

Caution indicates a hazard with a low level of risk which, if not avoided, could result in minor or moderate injury.



Warning

Warning indicates a hazard with a medium level of risk which, if not avoided, could result in death or serious injury.



Danger

Danger indicates a hazard with a high level of risk which, if not avoided, will result in death or serious injury.

Warning

1. The compatibility of the product is the responsibility of the person who designs the equipment or decides its specifications.

Since the product specified here is used under various operating conditions, its compatibility with specific equipment must be decided by the person who designs the equipment or decides its specifications based on necessary analysis and test results.

The expected performance and safety assurance of the equipment will be the responsibility of the person who has determined its compatibility with the product.

This person should also continuously review all specifications of the product referring to its latest catalog information, with a view to giving due consideration to any possibility of equipment failure when configuring the equipment.

2. Only personnel with appropriate training should operate machinery and equipment.

The product specified here may become unsafe if handled incorrectly.

The assembly, operation and maintenance of machines or equipment including our products must be performed by an operator who is appropriately trained and experienced.

3. Do not service or attempt to remove product and machinery/equipment until safety is confirmed.

1. The inspection and maintenance of machinery/equipment should only be performed after measures to prevent falling or runaway of the driven objects have been confirmed.

2. When the product is to be removed, confirm that the safety measures as mentioned above are implemented and the power from any appropriate source is cut, and read and understand the specific product precautions of all relevant products carefully.

3. Before machinery/equipment is restarted, take measures to prevent unexpected operation and malfunction.

4. Contact SMC beforehand and take special consideration of safety measures if the product is to be used in any of the following conditions.

1. Conditions and environments outside of the given specifications, or use outdoors or in a place exposed to direct sunlight.

2. Installation on equipment in conjunction with atomic energy, railways, air navigation, space, shipping, vehicles, military, medical treatment, combustion and recreation, or equipment in contact with food and beverages, emergency stop circuits, clutch and brake circuits in press applications, safety equipment or other applications unsuitable for the standard specifications described in the product catalog.

3. An application which could have negative effects on people, property, or animals requiring special safety analysis.

4. Use in an interlock circuit, which requires the provision of double interlock for possible failure by using a mechanical protective function, and periodical checks to confirm proper operation.



Safety Instructions

Caution

1. The product is provided for use in manufacturing industries.

The product herein described is basically provided for peaceful use in manufacturing industries. If considering using the product in other industries, consult SMC beforehand and exchange specifications or a contract if necessary. If anything is unclear, contact your nearest sales branch.

Limited warranty and Disclaimer/Compliance Requirements

The product used is subject to the following “Limited warranty and Disclaimer” and “Compliance Requirements”.

Read and accept them before using the product.

Limited warranty and Disclaimer

1. The warranty period of the product is 1 year in service or 1.5 years after the product is delivered.*2)

Also, the product may have specified durability, running distance or replacement parts. Please consult your nearest sales branch.

2. For any failure or damage reported within the warranty period which is clearly our responsibility, a replacement product or necessary parts will be provided.

This limited warranty applies only to our product independently, and not to any other damage incurred due to the failure of the product.

3. Prior to using SMC products, please read and understand the warranty terms and disclaimers noted in the specified catalog for the particular products.

***2) Vacuum pads are excluded from this 1 year warranty.**

A vacuum pad is a consumable part, so it is warranted for a year after it is delivered.

Also, even within the warranty period, the wear of a product due to the use of the vacuum pad or failure due to the deterioration of rubber material are not covered by the limited warranty.

Compliance Requirements

1. The use of SMC products with production equipment for the manufacture of weapons of mass destruction(WMD) or any other weapon is strictly prohibited.

2. The exports of SMC products or technology from one country to another are governed by the relevant security laws and regulation of the countries involved in the transaction. Prior to the shipment of a SMC product to another country, assure that all local rules governing that export are known and followed.



VT307 Series

3 port solenoid valve/ Precautions (1)

Be sure to read before handling.

Design / Selection

Warning

(1) Check the specifications.

This product is designed only for use in compressed air systems (including vacuum).

Do not operate at pressures or temperatures, etc., beyond the range of specifications, as this can cause damage or malfunction. (Refer to the specifications.)

Contact SMC when using a fluid other than compressed air (including vacuum).

We do not guarantee against any damage if the product is used outside of the specification range.

(2) Actuator drive.

When an actuator, such as a cylinder, is to be driven using a valve, take appropriate measures (cover installation or approach prohibition) to prevent potential danger caused by actuator operation.

(3) Effect of back-pressure when using a manifold.

Use caution when the valve is used on a manifold, because an actuator may malfunction due to back-pressure.

Especially, when a single acting cylinder is operated, caution is necessary. When there is a danger of such malfunction, take countermeasures such as using an individual EXH manifold.

(4) Holding pressure (including vacuum)

Since the valves are subject to air leakage, they cannot be used for applications such as holding pressure (including vacuum) in a pressure vessel.

(5) Not suitable for use as an emergency shut-off valve, etc.

These valves are not designed for safety applications such as an emergency shutoff valve. If the valves are used for the mentioned applications, additional safety measures should be adopted.

(6) Release of residual pressure

For maintenance purposes install a system for releasing residual pressure.

(7) Operation in a vacuum condition

When a valve is used for switching a vacuum, take measures to install a suction filter or similar to prevent external dust or other foreign matter from entering inside the valve.

In addition, at the time of vacuum adsorption, be sure to vacuum at all times. Failure to do so may result in foreign matter sticking to the adsorption pad, or air leakage causing the workpiece to drop.

(8) Vacuum switching valves and vacuum release valves

If a non-vacuum valve is installed in the middle of a piping system having a vacuum, the vacuum condition will not be maintained. Use a valve designed for use under vacuum conditions.

(9) Ventilation

Provide ventilation when using a valve in a confined area, such as in a closed control panel. For example, install a ventilation opening, etc. in order to prevent pressure from increasing inside of the confined area and to release the heat generated by the valve.

Design/ Selection

(10) Energizing for extended periods of time

Caution hot surface

* Be aware that the valve surface may get hot.

If a valve is continuously energized for an extended period of time, the temperature of the valve will increase due to the heat generated by the coil. This will likely adversely affect the performance of the solenoid valve and any nearby peripheral equipment. Therefore, when the total energizing time per day is expected to be longer than the total de-energizing time per day, use a low-wattage type or continuous duty type valve.

Depending on the operating conditions, it may be possible to use valves which are not mentioned above. Please contact SMC. In addition, it is possible to shorten the energizing time by using a N.O. (normal open) valve.

When the valve is mounted onto a control panel, incorporate measures to limit the heat radiation so that it is within the operating temperature range.

For example, the temperature will be high when a 3 station manifold or larger is put next to other valves and continuously energised.

(11) Disassembly and modification prohibited

Do not disassemble the product or make any modifications, including additional machining.

It may cause human injury and/or an accident and will void the warranty.

Caution

(1) Leakage voltage

When a resistor and a switching element are used in parallel or C-R device (surge voltage suppressor) is used for the protection of the switching device, note that leakage voltage will increase because earth leakage current passes through the resistor and C-R device. Therefore, suppressor residual voltage leakage should be as follows.

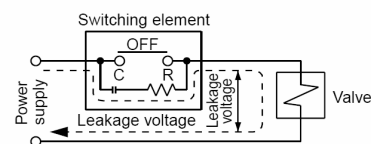

DC coil 3% or less of rated voltage

AC coil 15% or less of rated voltage

(2) Solenoid valve drive for AC with a solid state output (SSR, TRIAC output, etc)

1) Current leakage

When using a snubber circuit (C-R element) for surge protection of the output element, a very small amount of electrical current will flow even during OFF state.

This results in the valve not returning. In a situation where the tolerance is exceeded, as in the above case, take measures to install a bleeder resistor.

2) Minimum allowable load amount (Min. load current)

When the current consumption of the valve is less than the output's minimum allowable load volume or the margin is small, the output may not switch normally. Please contact SMC.



VT307 Series

3 port solenoid valve/ Precautions (2)

Be sure to read before handling.

Design / Selection

⚠ Caution

(3) Surge voltage suppressor

If a surge protection circuit contains nonstandard diodes, such as Zener diodes or varistor, a residual voltage that is in proportion of the protective circuit and the rated voltage will remain. Therefore, take into consideration the surge voltage protection of the controller.

The residual voltage of the diode is approximately 1V.

(4) Operation in a low temperature condition

It is possible to operate this valve in extreme temperature, as low as -10°C . Take appropriate measures to avoid freezing of drainage, moisture etc. in low temperature.

(5) Mounting orientation

Mounting orientation is unrestricted.

Mounting

⚠ Warning

(1) Operation Manual (this document)

Install and operate this valve only after reading the operation manual carefully and understanding the contents. Also, keep the manual where it can be referred to as necessary.

(2) Maintenance space

When installing the products, allow access for maintenance and inspection.

(3) Observe the tightening torque for screws.

When installing the products, follow the listed torque specifications.

(4) If air leakage increases or equipment does not operate properly, stop operation.

Check mounting conditions when air and power supplies are connected. Initial function and leakage tests should be performed after installation.

(5) Painting and coating

Warnings or specifications printed or affixed to the product should not be erased, removed or covered up.

Please consult with SMC before applying paint to resinous parts, as this may have an adverse effect due to the solvent in the paint.

Piping

⚠ Caution

(1) Preparation before piping

Before piping is connected, it should be thoroughly blown out with air (flushing) or washed to remove chips, cutting oil and other debris from inside the pipe.

(2) Sealant tape

When screwing piping or fittings into ports, ensure that chips from the pipe threads or sealing material do not enter the piping. Also, if pipe tape is used, leave 1 thread ridge exposed at the end of the threads.

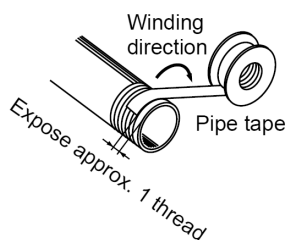

Piping

⚠ Caution

(3) Connection of fittings

When screwing fittings into valves, tighten as follows.

Tightening Torque for applicable piping

Connection thread	Proper tightening torque (N·m)
Rc 1/8	7 to 9
Rc 1/4	12 to 14

(4) Piping to products

When piping to a product, refer to the catalog to avoid mistakes in the position of the supply port, etc.

Wiring

⚠ Caution

(1) Polarity

When connecting power to a solenoid valve with DC specification and equipped with a light or surge voltage suppressor, check for polarity.

If there is polarity, take note of the following.

(2) Applied voltage:

When electric power is connected to the solenoid valve, be careful to apply the proper voltage. Improper voltage may cause malfunction or coil damage and void the warranty. Operation failure or burnout could result.

(3) Check the connections.

Check if the connections are correct after completing all wiring.

Lubrication

⚠ Warning

(1) Lubrication

1) The product has been lubricated for life by the manufacturer and therefore, does not require lubrication while in service.

2) If a lubricant is used in the system, use class 1 turbine oil (no additives), ISO VG32.

Once a lubricant is used in the system, lubrication must be continued because the original lubricant applied during manufacture will be washed away.

If turbine oil is used, refer to its Material Safety Data sheet (MSDS) of the oil.

Air Supply

⚠ Warning

(1) Type of fluids

Please consult with SMC when using the product in applications other than compressed air.

(2) When there is a large amount of drainage

Compressed air containing a large amount of drainage can cause malfunction of pneumatic equipment. An air dryer or water separator should be installed upstream from filters.



VT307 Series

3 port solenoid valve/ Precautions (3)

Be sure to read before handling.

Air Supply

Warning

(3) Drain flushing

If condensation in the drain bowl is not emptied on a regular basis, the bowl will overflow and allow the condensate to enter the compressed air lines. This will cause a malfunction of pneumatic equipment. If the drain bowl is difficult to check and remove, installation of a drain bowl with an auto drain option is recommended.

For detailed information regarding the quality of the compressed air described above, refer to SMC's Best Pneumatics catalog.

(4) Use clean air.

Do not use compressed air that contains chemicals, synthetic oils including organic solvents, salts or corrosive gases, etc., as this can cause damage or malfunction.

Caution

(1) When extremely dry air is used as the fluid, degradation of the lubrication properties inside the equipment may occur, resulting in reduced reliability (or reduced service life) of the product. Please consult with SMC.

(2) Install an air filter.

Install an air filter upstream near the valve. Select an air filter with a filtration degree of 5 µm or smaller.

(3) Take appropriate measures to ensure air quality, such as by installing an aftercooler, air dryer, or water separator.

Compressed air that contains a large amount of drainage can cause malfunction of pneumatic equipment such as valves. Therefore, take appropriate measures to ensure air quality, such as by providing an aftercooler, air dryer, or water separator.

(4) If excessive carbon powder is seen, install a mist separator on the upstream side of the valve.

If excessive carbon powder is generated by the compressor, it may adhere to the inside of a valve and cause it to malfunction.

For detailed information regarding the quality of the compressed air described above, refer to SMC's Best Pneumatics catalog.

Operating environment

Warning

(1) Do not use in an atmosphere having corrosive gases, chemicals, sea water, water, water steam, or where there is a direct contact with any of these.

(2) Do not use in an environment where flammable gas or explosive gas exists. Usage may cause fire or explosion. The products do not have an explosion proof construction.

(3) Do not use in a place subject to heavy vibration and/or shock.

(4) The valve should not be exposed to prolonged sunlight. Use a protective cover.

Operating environment

Warning

(5) Remove any sources of excessive heat.

(6) If it is used in an environment where there is possible contact with oil, weld spatter, et., exercise preventive measures.

(7) When the solenoid valve is mounted in a control panel or its energized for a long time, make sure the ambient temperatures is within the specification of the valve.

Maintenance check

Warning

(1) Perform maintenance inspection according to the procedures indicated in the operation manual (this document).

If handled improperly, malfunction and damage of machinery or equipment may occur.

(2) Removal of equipment, and supply/exhaust of compressed air

When components are removed, first confirm that measures are in place to prevent workpieces from dropping, run-away equipment, etc. Then, cut off the supply pressure and electric power, and exhaust all compressed air from the system using the residual pressure release function.

When the equipment is to be operated after remounting or replacement, first confirm that measures are in place to prevent lurching of actuators, etc., Then confirm that the equipment is operating normally.

(3) Low frequency operation

Valves should be operated at least once every 30 days to prevent malfunction. (Use caution regarding the air supply.)

(4) Manual override operation

When the manual override is operated, connected equipment will be actuated.

Operate after safety is confirmed.

Caution

(1) Drain flushing

Remove drainage from air filters regularly.

(2) Lubrication

Once lubrication has been started, it must be continued.

Use class 1 turbine oil (with no additive), ISO VG32. If other lubricant oil is used, it may cause malfunction.



VT307 Series 3 port solenoid valve Specific Product Precautions (1)

Be sure to read before handling.

How to use DIN connector

Disassembly

- Loosen screw (1) and pull up housing (2) in the direction of screw (1) to remove the connector from the body (solenoid).
- Pull out screw (1) from housing (2).
- On the bottom part of terminal block (3), there is a notch (9). If a small flat head screwdriver is inserted into the gap between housing (2) and terminal block (3), terminal block (3) will be removed from housing (2). (See diagram at the top right of the page.)
- Remove cable gland (4), washer (5) rubber seal (6).

Wiring

- Insert cable gland (4), washer (5) and rubber seal (6) into cable (7) in order, and insert it into housing (2).
- Loosen screws (11) on terminal (3). Insert lead wires (10) and tighten screws (11) again.

Note 1) The tightening torque should be 0.5 N·m +/- 15%.

Note 2) The applicable outside diameter of cable (7) is $\phi 6$ to 8 mm.

Note 3) Round or Y-shaped crimped terminal cannot be used.

Assembly

- Insert cable gland (4), washer (5) and rubber seal (6) and housing (2) into cable (7) in order. Connect cable (7) to terminal block (3) and fix terminal block (3) to housing (2) in place. (Push it down until you hear the click sound.)
- Insert rubber seal (6) and washer (5) into the cable entry on housing (2) in order, and tighten cable gland (4) securely.
- Insert gasket (8) into the gap between the bottom of terminal box (3) and plug on the equipment, and insert screw (1) from the top of housing (2) to tighten them.

Note 1) The tightening torque should be 0.5 N·m +/- 20%.

Note 2) The orientation of the connector can be changed by 180 degrees depending on the mounting direction of housing (2) and terminal box (3).

Connector for DIN Terminal

Description	Part no.
DIN connector	B1B09-2A (Standard)
	GM209NJ-B17 (CE-compliant)

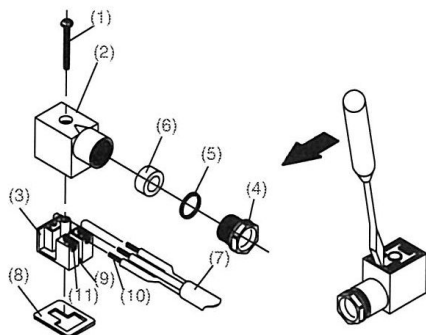

Indicator Light/Surge Voltage Suppressor

Caution

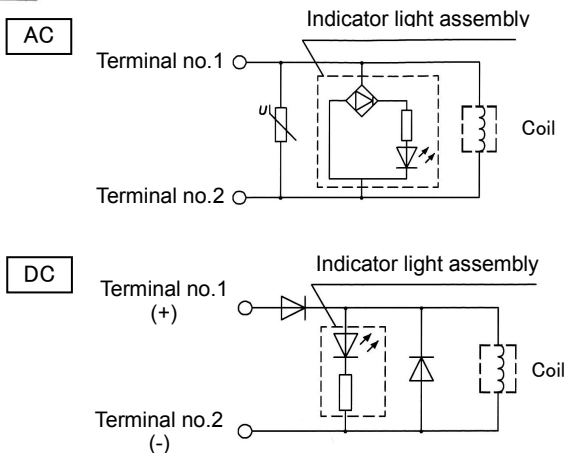

Electrical Connection

Caution

The DIN connector terminal and conduit terminal (with indicator light/surge voltage suppressor) are wired internally as shown below. Connect each of the wire to the corresponding wire of the power supply.

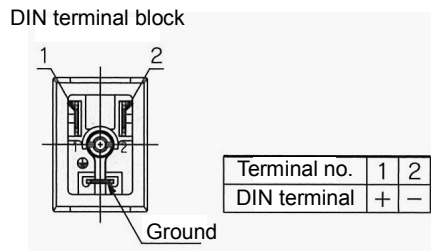

- Applicable cord outside diameter
D type: $\phi 6$ to 8 mm

Lead wire colour

Voltage specification	Colour
100 VAC	Blue
200 VAC	Red
DC polar indication	Red (+), black (-)
Others	Gray

Continuous energizing time

Caution

If the standard and low-power consumption types are energized continuously for a long time, switch the valve at least once every 30 days and the operating time should not exceed 1400 hours (equivalent to 2 months) per year. Cannot be used as an emergency shutoff valve. If the operating time exceeds 1400 hours, use a continuous duty type valve (VT307E).

Note that the valve should be switched at least once every 30 days in this case.

If the valve is used for special applications (e.g. emergency shutdown valve), please contact your SMC sales representative.



VT307 Series 3 port solenoid valve/ Specific Product Precautions (2)

Be sure to read before handling.

Operation in a vacuum condition

⚠ Caution

For operation in a vacuum condition, use VT/O307V. Note that if the valve is used in an environment where the product is exposed to a large amount of dust, install a filter to the R port. If a suction pad is used, install a filter between the suction pad and valve. However, they have a different application from the vacuum retaining solenoid valve.

Manifold

⚠ Caution

- (1) Each valve is fixed to the manifold base with two M4 mounting screws. Tighten the screws evenly when re-mounting.
- (2) For mounting, tighten M4 or equivalent screws evenly into the mounting holes of the manifold base.
Tightening torque of the mounting screws (M4): 1.4 N·m

⚠ Warning

- (1) When using the manifold, if the actuator may malfunction due to back-pressure, use an individual exhaust type manifold.
- (2) When mounting a valve on the manifold base, N.C. and N.O. can be reversed depending on the orientation of the function plate. Because the cylinder operation is reversed, confirm if the function plate is correctly mounted or not.

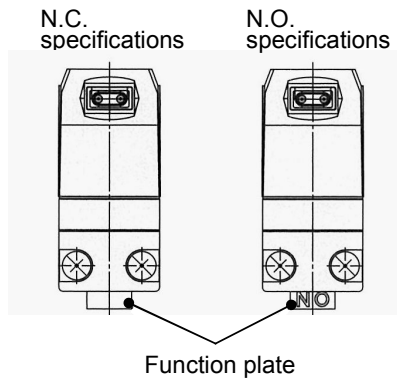

Changing from N.C. to N.O.

⚠ Caution

This product is delivered as a N.C. valve. If a N.O. valve is needed, remove the mounting screw of the valve and turn over the function plate. (Make sure that there are gaskets on both sides of the plate.) Then tighten the mounting screws to fix the valve to the manifold base.

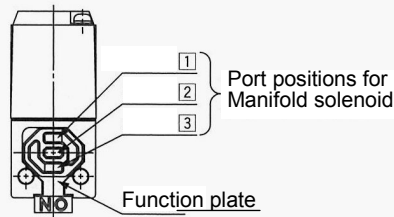

This figure (bottom view) shows the N.C. specification.

Specifications	Mark on the surface of the function plate
N.C.	No mark
N.O.	NO

Port Direction

⚠ Caution

When using common exhaust manifold, pressurization or evacuation of the R port can cause a malfunction.

Troubleshooting

Should any trouble occur during operation, trace the source of the problem in the following list and take appropriate countermeasures.

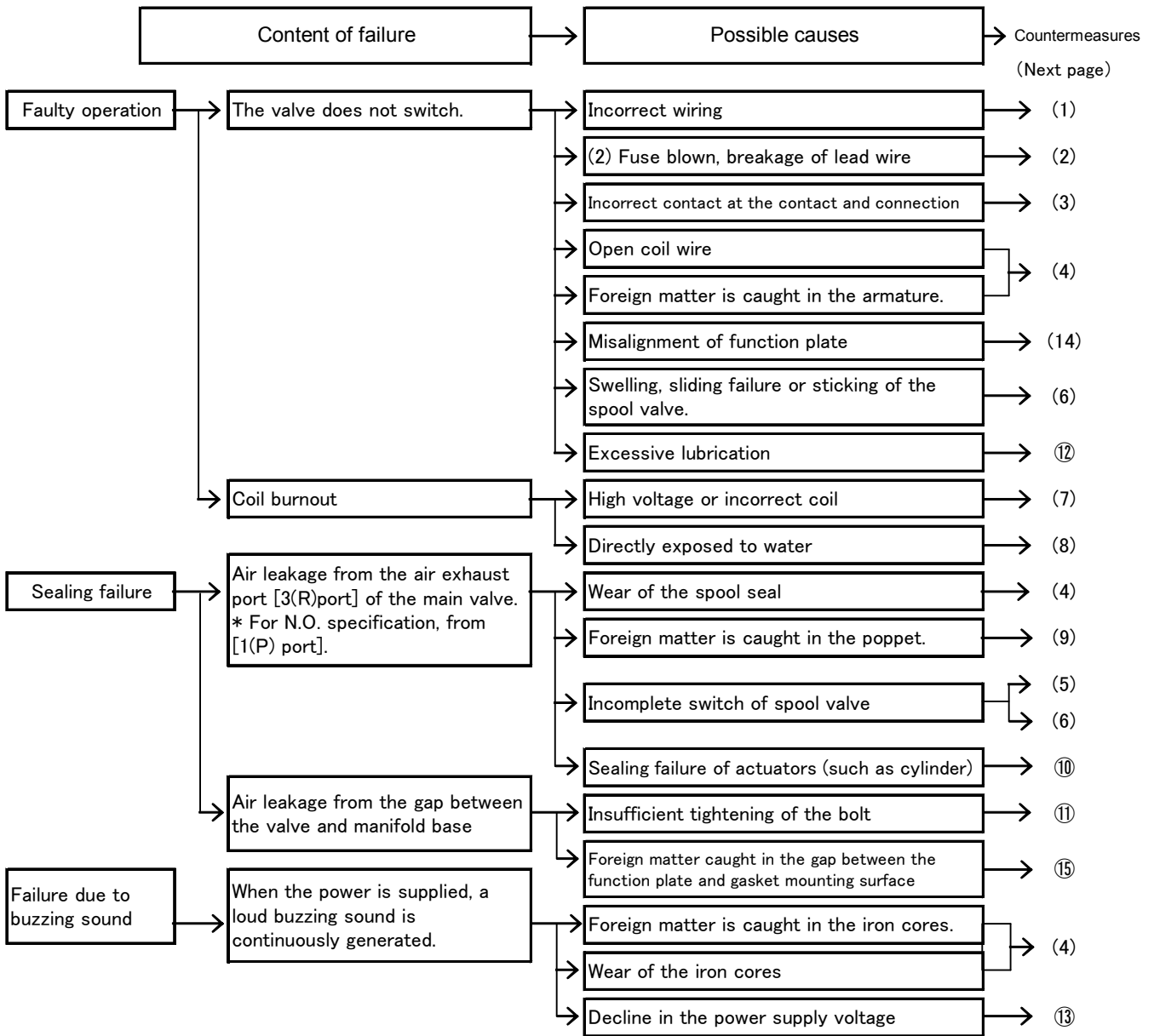

Countermeasures

No.	Countermeasures
(1)	Connect wires correctly.
(2)	Replace the part.
(3)	Replace the part or connect wires correctly.
(4)	Replace the valve.
(5)	Adjust the pressure so that the pilot pressure stays within the specification range at the time of operation.
(6)	If incorrect oil has been used for lubrication, remove the oil using a pneumatic blow gun, and replace the valve with a new one. If a lubricant is used in the system after the replacing the valve, use turbine oil Class 1 (with no additive) ISO VG32. If there is a large amount of condensation or condensate cannot be removed completely, mount an auto drain or install a dryer and replace the valve.
(7)	Check the voltage and replace the valve.
(8)	Protect the valve especially the coil to prevent it from being exposed to water.
(9)	If air leakage is caused by foreign matter, remove the foreign matter in the piping using a pneumatic blow gun and replace the valve.
⑩	Repair or replace the actuators.
⑪	Stop the air and additionally tighten the bolt.
⑫	Reduce the amount of lubrication to the amount at which the oil does not splash from the exhaust port [3(R) port]. * For N.O. specification, from [1(P) port].
⑬	Adjust the voltage so that voltage during operation will satisfy the specification.
⑭	Align the function plate.
⑮	Remove foreign matter.

If the countermeasures above are not effective, there may be a problem with the valve. In that case, stop using the valve immediately.

If any of the examples below are applicable, there may be an internal problem in the valve. In that case, stop using the valve immediately.

1. Voltage was outside of the rated voltage.
2. Oils other than specified were supplied.
3. Lubrication was stopped in the middle of lubrication. Or, lubrication was interrupted temporarily
4. Directly exposed to water
5. Severe impact was applied.
6. Foreign matter such as condensate or rubber entered.
7. Other than those specified, if precautions on the operation manual apply.

If the product malfunctions, please return the valve as it is.

Revision history

A	Precautions on Design / Selection	QZ
---	-----------------------------------	----

1st printing:QV

SMC Corporation

4-14-1, Sotokanda, Chiyoda-ku, Tokyo 101-0021 JAPAN

Tel: + 81 3 5207 8249 Fax: +81 3 5298 5362

URL <http://www.smcworld.com>

Note: Specifications are subject to change without prior notice and any obligation on the part of the manufacturer.
© 2008 SMC Corporation All Rights Reserved



VT307-OMQ0002-A