

Product manual

Miniature – Push button switches SMS(Surface mount) and PMS(PCB mount).

CONTENT

1. Product Description

SMS/PMS Base module
SMS/PMS Variable Height

2. Technical data and dimensions

Technical data SMS/PMS
Dimensions SMS/ PMS Base module/Variable Height
Drilling diagram and Solder pads SMS/PMS Base module /Variable height
Circuit Diagram SMS/PMS

3. Part numbers

Part numbers SMS/PMS Base module/Variable Height

4. Packaging

Packaging SMS/PMS Base Module/Variable Height

5. Qualification Tests

6. ROHS Compliant



Changes that contribute to technical improvement are subject to alternations

Page	Production date:	Produced by:	Modification date:	Modified by:	Modification No.	Data sheet No.	Index
1 of 9	07.07.2005	Lickert	15.06.2006	M.Fischer	9235	105.9513	-

Print date: 6/15/2007 2:39:00 PM

1 Description

1.1 SMS/PMS Base module

Miniature push button switches with a low height of 4,55 - 4,95 mm for surface mounting (SMS) and PCB mounting (PMS).

The SMS has large flat surfaces on the top side as well as on the other sides, which are also parallel to each other. This makes the SMS a perfect switch for automatic mounting.

The SMS switch is suitable for the SMD soldering process "IR-Reflow".

The switch comes with the SMD-leads "Gullwing and J". With J-leads the switch can be lined up with a spacing of 1/2" in one coordinate direction, and with > 13,5 mm in the other coordinate direction. With Gullwing-leads, the switch can be arranged with a spacing of 1/2" in one coordinate direction, and in the other coordinate direction with > 17,5 mm.

A minimum spacing of 1/2" to 15 mm is necessary for the PCB version.

Basically, the SMS and PMS come in two basic versions concerning the degree of protection. Available are IP 40 and IP 67. According to the degree of protection the IP 40 version is not proof against fluxing and washing, whereas the IP 67 version is. Consequently, the IP 67 version can be exposed to the specified soldering and cleaning processes.

The miniature push button switches feature a very good tactile response with an actuation force of about 2N. SMS and PMS are also available with an elongated actuator. These variants serve as base modules for the SMS/PMS variable height version.

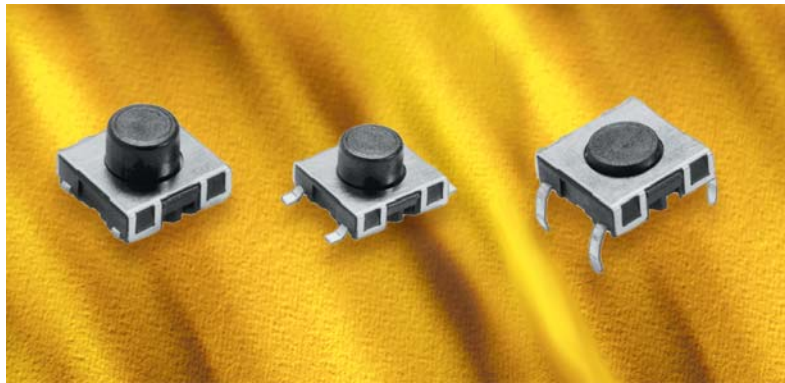

1.2 SMS/PMS Variable Height

The variable height SMS/PMS consists of the SMS/PMS base module with elongated actuator and a slip-on button with eight variable heights.

The PMS will be supplied with a mounted button. The button for the SMS has to be ordered separately. After soldering, the button must be put on the base module with elongated actuator.

Heights between 8,5 mm and 13,75 mm for the SMS and 8,35 mm and 13,60 mm for the PMS are available. Depending on the base module being used, degree of protection for the variable height SMS/PMS is IP 40 or IP 67.



Changes that contribute to technical improvement are subject to alternations

Page	Production date:	Produced by:	Modification date:	Modified by:	Modification No.	Data sheet No.	Index
2 of 9	07.07.2005	Lickert	15.06.2006	M.Fischer	9235	105.9513	-

2 Data and dimensional drawings

2.1 Technical Data SMS/PMS Base module/Variable Height

Electrical data:	IP40	IP67
Contact material	Gold ; Gold/Silver ⁽¹⁾	Gold
Switching voltage max.	30V AC/ 42V DC	30V AC/ 42V DC
Switching current max.	50 mA	50 mA
Rated breaking capacity	12 V/10 mA	12 V/10 mA
Lifetime (at 12V/10mA)	>1 x 10 ⁶ cycles	>1x10 ⁶ cycles
Lifetime (at 24V/80mA)	- ; >1x10 ⁵ ⁽¹⁾	-
Initial contact resistance new (IEC 512-2 mV-method)	<50 mOhm	<50 mOhm
Initial contact resistance after 1 x 10 ⁶ cycles	<150 mOhm	<150 mOhm
Insulation resistance (IEC 512-2)	> 1x 10 ⁸ Ohm	> 1x 10 ⁸ Ohm
Contact bounce time	typ. 0,15 ms	typ. 0,15 ms

Mechanical data:	IP40	IP67
Actuating force	1,8±0,4 N	2,2±0,4 N
Actuating travel	0,35±0,1 mm	0,35±0,1 mm
Mechanical strength (force axial, load 1 min.)	max. 100 N	max. 100 N
Lifetime (IEC 512-5. Test 9a. Actuating force 5N)	>1x 10 ⁶ cycles	>1x 10 ⁶

Soldering data:	SMS IP40/IP67	PMS IP40/IP67
Soldering method	IR Reflow	Wave soldering
Soldering heat resistance	245 °C/5sec.	248,5 °C/1sec

⁽¹⁾ PMS Typ 1241.1652

Changes that contribute to technical improvement are subject to alternations

Recommended IR-Reflow Profile for SMS

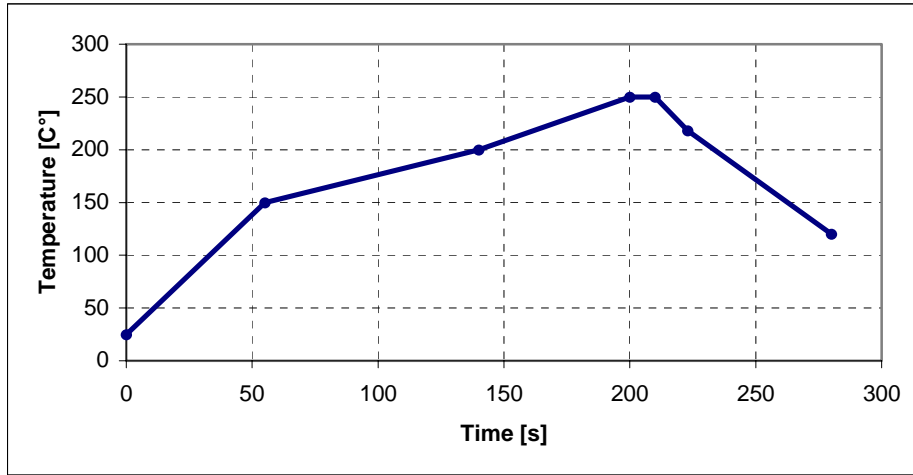

Tolerance for Temperature settings T +0°C (according to JEDEC J-STD-020C, July 2004)

Used Solder: Omnix O338 (Sn95.5%/Ag4%/Cu0.5%), Alpha Metals Loetsysteme GmbH

Recommended Wave Soldering Profile for PMS

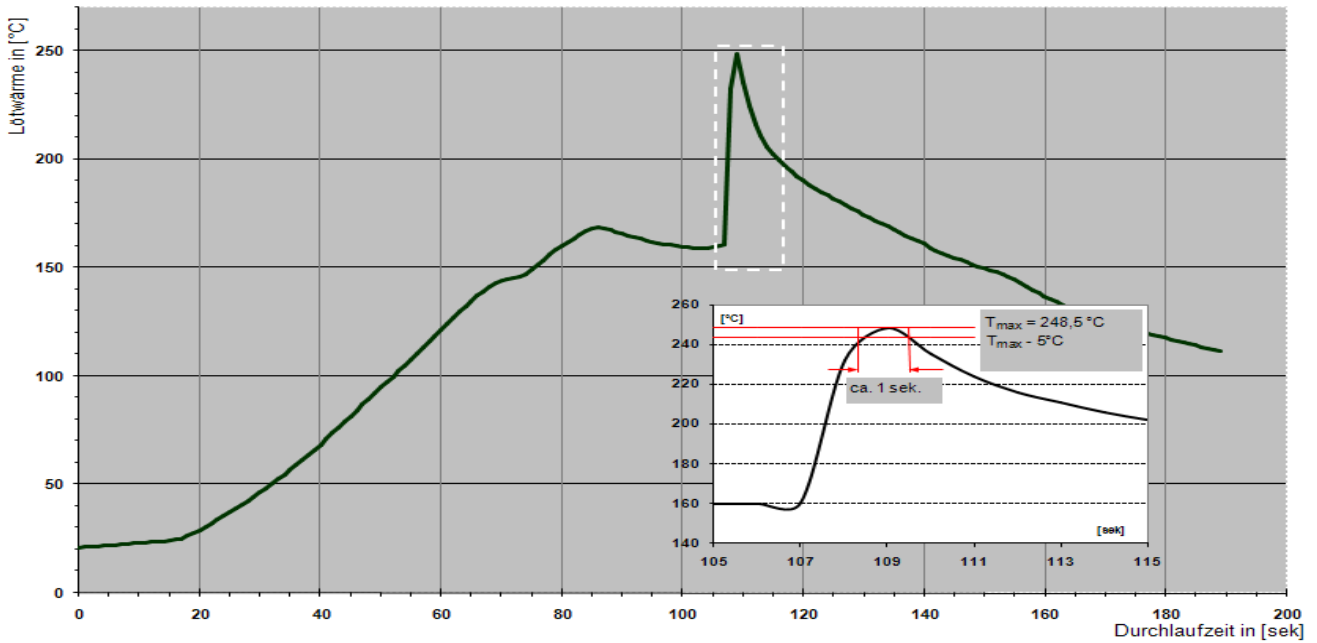

Wave Soldering Equipment: **ERSA EMS 3300**
 Throughput speed: 1m / min
 Solder type: Sn100C from Nihon Superior (Balver-Solder)
 Flux material: AW30 Fa. Otto

Adjustments Heating Zones

Upper Zone :	280 °C	300 °C	
Lower Zone:	450°C	500 °C	560 °C

Changes that contribute to technical improvement are subject to alternations

Page	Production date:	Produced by:	Modification date:	Modified by:	Modification No.	Data sheet No.	Index
4 of 9	07.07.2005	Lickert	15.06.2006	M.Fischer	9235	105.9513	-

Other data:	SMS	PMS	SMS	PMS
	IP40	IP40	IP67	IP67
Operating temperature(°C)	-40 to 85	-40 to 85	-40 to 85	-40 to 85
Storage temperature(°C)	-40 to 85	-40 to 85	-40 to 85	-40 to 85
Degree of protection (DIN 40050)	IP40	IP40	IP67	IP67
Cleaning agent proof applied test agent ³⁾	Zestron	Zestron	Zestron	Zestron
Flux proof ¹⁾	_____	_____	given	given
Wash proof ²⁾	_____	_____	given	given

- 1) Visual inspection of switch chamber after immersion in colliophonium solution flux for 3 seconds.
2) Inspection of switch chamber after washing process
3) CKW and FCKW free mix made of water soluble Glykolether

Mechanical data:		SMS/PMS	SMS/PMS
Component	Flammability rating	IP40	IP67
Socket	UL94 V-0	Thermoplast (PA 4.6)	Thermoplast (PA 4.6)
Actuator	UL94 V-0	Thermoplast (PPS)	Thermoplast (PPS)
Cover plate		X12 Cr Ni 17 7	X12 Cr Ni 17 7
Sealing membrane	UL94 HB	_____	VMQ
Elongated button	UL94 V-2	Thermoplast (PC)	Thermoplast(PC)

Electrical data(material):	SMS/PMS	SMS/PMS
	IP40	IP67
Snap dome	X12 CrNi 17 7 gold plated on contact side	
Contacts	CuZn37 with Ni/Au coated; with Ag coated ⁽¹⁾	
Terminals(leads)	CuZn37 with Sn coated	

Changes that contribute to technical improvement are subject to alternations

Page	Production date:	Produced by:	Modification date:	Modified by:	Modification No.	Data sheet No.	Index
5 of 9	07.07.2005	Lickert	15.06.2006	M.Fischer	9235	105.9513	-

Print date: 6/15/2007 2:39:00 PM

2.2 Dimensions SMS/PMS Base module/variable height

SMS Gullwing Base module

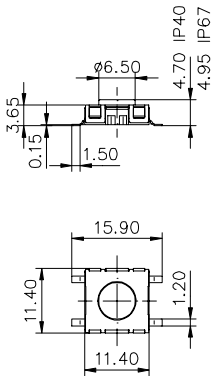

SMS J-lead Base module

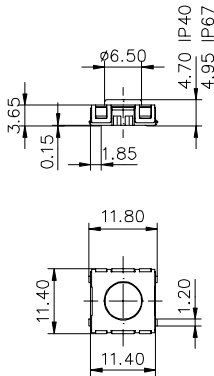

PMS PCB Base module

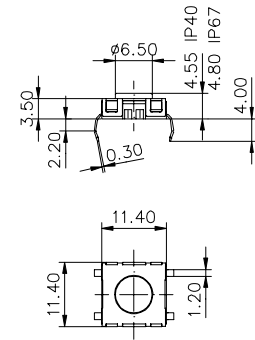

SMS Gullwing Variable height

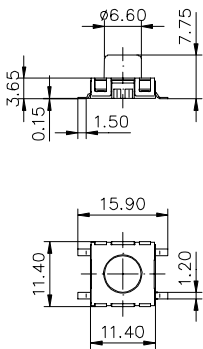

SMS J-lead Variable height

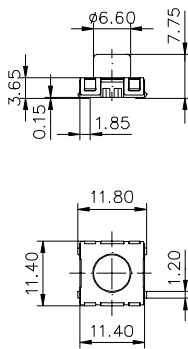

PMS PCB Variable height

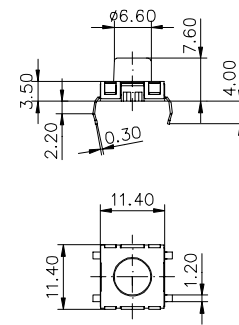

SMS Gullwing and J lead with elongated button

PMS PCB with elongated button

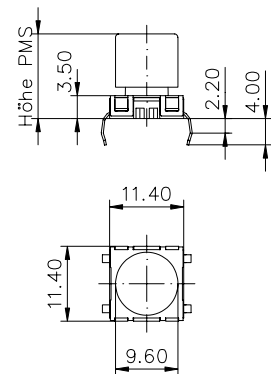
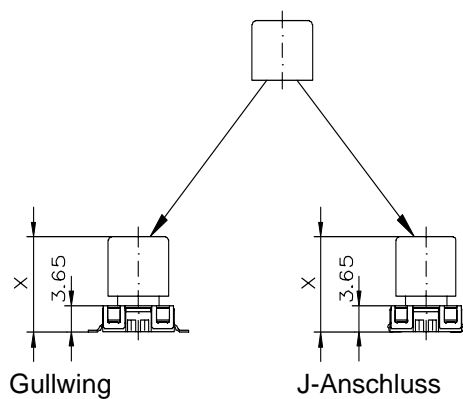

Total height information: **See point 3.1**, Part numbers SMS und PMS Variable height, SMS elongated button must be ordered separately.

Changes that contribute to technical improvement are subject to alternations

Page	Production date:	Produced by:	Modification date:	Modified by:	Modification No.	Data sheet No.	Index
6 of 9	07.07.2005	Lickert	15.06.2006	M.Fischer	9235	105.9513	-

2.3 Drilling diagram and Solder pads SMS/PMS Base module/variable height

Gullwing lead

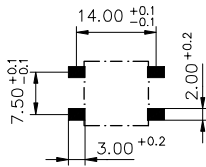

J-lead

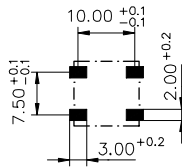

PCB lead

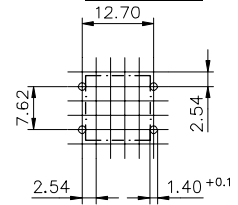

2.4 Circuit Diagram SMS/PMS

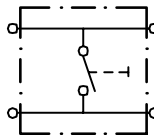

Changes that contribute to technical improvement are subject to alternations

Page	Production date:	Produced by:	Modification date:	Modified by:	Modification No.	Data sheet No.	Index
7 of 9	07.07.2005	Lickert	15.06.2006	M.Fischer	9235	105.9513	-

3 Part numbers

3.1 Part numbers SMS/PMS Base module/Variable Height

Part-Nr. Base module

Type	IP40	IP67
Gullwing lead	1241.1600.XX	1241.1606.XX
J-lead	1241.1601.XX	1241.1607.XX
Through hole lead	1241.1602	1241.1608

Part-Nr. Elongated base module

Type	IP40	IP67
Gullwing lead	1241.1612.XX	1241.1618.XX
J-lead	1241.1613.XX	1241.1619.XX
Through hole lead	1241.1614	1241.1620

Ordering example

Base module

1241.XXXX.XX

- └─ Index 11 loose in boxes
- └─ Index 23 Blister tape

Part-Nr. Variable height PMS

Height in mm	IP 40	IP67	Color
8,35	1241.1624.1	1241.1625.1	Yellow
9,10	1241.1624.2	1241.1625.2	Orange
9,85	1241.1624.3	1241.1625.3	Red
10,60	1241.1624.4	1241.1625.4	Blue
11,35	1241.1624.5	1241.1625.5	Green
12,10	1241.1624.6	1241.1625.6	Grey
12,85	1241.1624.7	1241.1625.7	Black
13,60	1241.1624.8	1241.1625.8	White

Part-Nr. Elongated buttons for SMS

Switch height SMS with mounted buttons in mm	Part-Nr.	Color
8,50	0862.8101	Yellow
9,25	0862.8102	Orange
10,00	0862.8103	Red
10,75	0862.8104	Blue
11,50	0862.8105	Green
12,25	0862.8106	Grey
13,00	0862.8107	Black
13,75	0862.8108	White

Changes that contribute to technical improvement are subject to alternations

Page	Production date:	Produced by:	Modification date:	Modified by:	Modification No.	Data sheet No.	Index
8 of 9	07.07.2005	Lickert	15.06.2006	M.Fischer	9235	105.9513	-

4 Packaging

4.1 Packaging SMS/PMS Base module/Variable Height

loose in boxes SMS/PMS - Index 11 for SMS	100 pieces
tape and reel for SMS base module - Index 23	700 pieces
tape and reel for SMS elonged. base module -Index 23	450 pieces

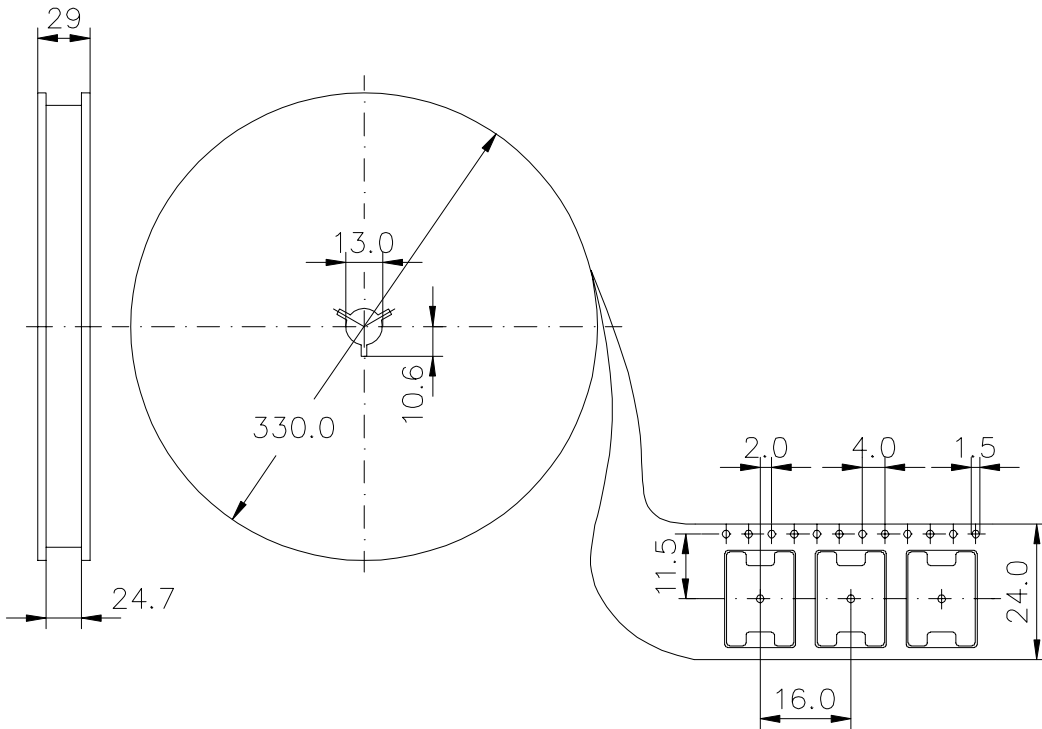

5 Qualification Tests

6 ROHS Compliant



Changes that contribute to technical improvement are subject to alternations

Page	Production date:	Produced by:	Modification date:	Modified by:	Modification No.	Data sheet No.	Index
9 of 9	07.07.2005	Lickert	15.06.2006	M.Fischer	9235	105.9513	-

Print date: 6/15/2007 2:39:00 PM