



Reference Specification

Leaded MLCC for Automotive with AEC-Q200
RCE Series

Product specifications in this catalog are as of Dec. 2017, and are subject to change or obsolescence without notice.

Please consult the approval sheet before ordering. Please read rating and Cautions first.

Reference only

⚠ CAUTION

1. OPERATING VOLTAGE

When DC-rated capacitors are to be used in AC or ripple current circuits, be sure to maintain the V_{p-p} value of the applied voltage or the V_{o-p} which contains DC bias within the rated voltage range. When the voltage is started to apply to the circuit or it is stopped applying, the irregular voltage may be generated for a transit period because of resonance or switching. Be sure to use a capacitor within rated voltage containing these irregular voltage.

When DC-rated capacitors are to be used in input circuits from commercial power source (AC filter), be sure to use Safety Recognized Capacitors because various regulations on withstand voltage or impulse withstand established for each equipment should be taken into considerations.

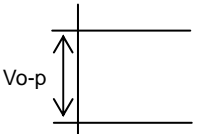
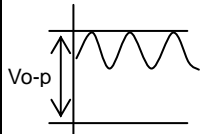
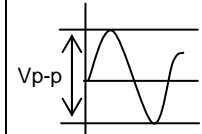
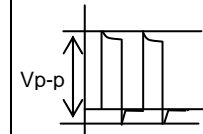
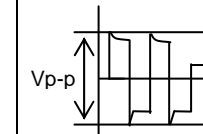
Voltage	DC Voltage	DC+AC Voltage	AC Voltage	Pulse Voltage(1)	Pulse Voltage(2)
Positional Measurement					

2. OPERATING TEMPERATURE AND SELF-GENERATED HEAT

Keep the surface temperature of a capacitor below the upper limit of its rated operating temperature range. Be sure to take into account the heat generated by the capacitor itself.

When the capacitor is used in a high-frequency current, pulse current or the like, it may have the self-generated heat due to dielectric-loss. In case of Class 2 capacitors (Temp.Char. : X7R,X7S,X8L, etc.), applied voltage should be the load such as self-generated heat is within 20 °C on the condition of atmosphere temperature 25 °C. Please contact us if self-generated heat is occurred with Class 1 capacitors (Temp.Char. : C0G,U2J,X8G, etc.). When measuring, use a thermocouple of small thermal capacity-K of $\phi 0.1$ mm and be in the condition where capacitor is not affected by radiant heat of other components and wind of surroundings. Excessive heat may lead to deterioration of the capacitor's characteristics and reliability.

3. Fail-safe

Be sure to provide an appropriate fail-safe function on your product to prevent a second damage that may be caused by the abnormal function or the failure of our product.

4. OPERATING AND STORAGE ENVIRONMENT

The insulating coating of capacitors does not form a perfect seal; therefore, do not use or store capacitors in a corrosive atmosphere, especially where chloride gas, sulfide gas, acid, alkali, salt or the like are present. And avoid exposure to moisture. Before cleaning, bonding, or molding this product, verify that these processes do not affect product quality by testing the performance of a cleaned, bonded or molded product in the intended equipment. Store the capacitors where the temperature and relative humidity do not exceed 5 to 40 °C and 20 to 70%. Use capacitors within 6 months.

5. VIBRATION AND IMPACT

Do not expose a capacitor or its leads to excessive shock or vibration during use.

6. SOLDERING

When soldering this product to a PCB/PWB, do not exceed the solder heat resistance specification of the capacitor. Subjecting this product to excessive heating could melt the internal junction solder and may result in thermal shocks that can crack the ceramic element.

7. BONDING AND RESIN MOLDING, RESIN COAT

In case of bonding, molding or coating this product, verify that these processes do not affect the quality of capacitor by testing the performance of a bonded or molded product in the intended equipment.

In case of the amount of applications, dryness / hardening conditions of adhesives and molding resins containing organic solvents (ethyl acetate, methyl ethyl ketone, toluene, etc.) are unsuitable, the outer coating resin of a capacitor is damaged by the organic solvents and it may result, worst case, in a short circuit.

The variation in thickness of adhesive or molding resin may cause a outer coating resin cracking and/or ceramic element cracking of a capacitor in a temperature cycling.

8. TREATMENT AFTER BONDING AND RESIN MOLDING, RESIN COAT

When the outer coating is hot (over 100 °C) after soldering, it becomes soft and fragile.

So please be careful not to give it mechanical stress.

Reference only

Failure to follow the above cautions may result, worst case, in a short circuit and cause fuming or partial dispersion when the product is used.

9. LIMITATION OF APPLICATIONS

Please contact us before using our products for the applications listed below which require especially high reliability for the prevention of defects which might directly cause damage to the third party's life, body or property.

1. Aircraft equipment
2. Aerospace equipment
3. Undersea equipment
4. Power plant control equipment
5. Medical equipment
6. Transportation equipment (vehicles, trains, ships, etc.)
7. Traffic signal equipment
8. Disaster prevention / crime prevention equipment
9. Data-processing equipment exerting influence on public
10. Application of similar complexity and/or reliability requirements to the applications listed in the above.

NOTICE

1. CLEANING (ULTRASONIC CLEANING)

To perform ultrasonic cleaning, observe the following conditions.

Rinse bath capacity : Output of 20 watts per liter or less.

Rinsing time : 5 min maximum.

Do not vibrate the PCB/PWB directly.

Excessive ultrasonic cleaning may lead to fatigue destruction of the lead wires.

2. Soldering and Mounting

Insertion of the Lead Wire

- When soldering, insert the lead wire into the PCB without mechanically stressing the lead wire.
- Insert the lead wire into the PCB with a distance appropriate to the lead space.

3. CAPACITANCE CHANGE OF CAPACITORS

- Class 2 capacitors (Temp.Char. : X7R,X7S,X8L, etc.)

Class 2 capacitors an aging characteristic, whereby the capacitor continually decreases its capacitance slightly if the capacitor leaves for a long time. Moreover, capacitance might change greatly depending on a surrounding temperature or an applied voltage. So, it is not likely to be able to use for the time constant circuit.

Please contact us if you need a detail information.

NOTE

1. Please make sure that your product has been evaluated in view of your specifications with our product being mounted to your product.
2. You are requested not to use our product deviating from this specification.

Reference only

1. Application

This specification is applied to Leaded MLCC RCE series in accordance with AEC-Q200 requirements used for Automotive Electronic equipment.

2. Rating

- Part number configuration

ex.)	RCE	R7	2E	103	K	1	K1	H03	B
	Series	Temperature Characteristic	Rated voltage	Capacitance	Capacitance tolerance	Dimension code	Lead code	Individual specification code	Packing style code

- Temperature characteristic

Code	Temp. Char.	Temp. Range	Cap. Change (Within%)	Standard Temp.	Operating Temp. Range
R7	X7R	-55~125°C	+/-15	25°C	-55~125°C

- Rated voltage

Code	Rated voltage
2E	DC250V
2J	DC630V
3A	DC1000V

- Capacitance

The first two digits denote significant figures ; the last digit denotes the multiplier of 10 in pF.
ex.) In case of 103.

$$10 \times 10^3 = 10000 \text{pF}$$

- Capacitance tolerance

Code	Capacitance Tolerance
K	+/-10%
M	+/-20%

- Dimension code

Code	Dimensions (LxW) mm max.
1	4.0 x 3.5
2	5.5 x 4.0
3	5.5 x 5.0
4	7.5 x 5.5
5	7.5 x 7.5 *
U	7.7 x 12.5 *

*DC630V, DC1000V : W+0.5mm

- Lead code

Code	Lead style	Lead spacing (mm)
B1	Straight type	5.0+/-0.8
E1	Straight taping type	5.0+0.6/-0.2
K1	Inside crimp type	5.0+/-0.8
M1	Inside crimp taping type	5.0+0.6/-0.2

Lead wire is solder coated CP wire.

Reference only

4. Part number list

• Inside Crimp
(Lead Code:K1)

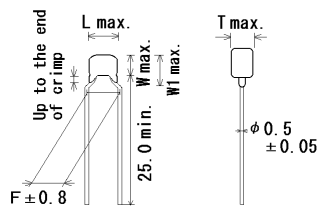

• Straight Long
(Lead Code: B1)

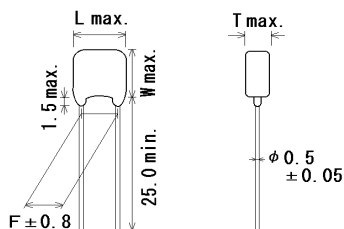

• Straight Long
(Size Lead Code:UB1)

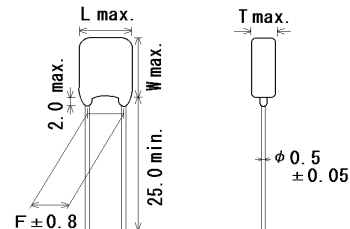

Unit : mm

Customer Part Number	Murata Part Number	T.C.	DC Rated Volt. (V)	Cap.	Cap. tol.	Dimension (mm)					Size Lead Code	Pack qty. (pcs)
						L	W	W1	F	T		
	RCER72E102K1K1H03B	X7R	250	1000pF	± 10%	4.0	3.5	5.0	5.0	3.15	1K1	500
	RCER72E152K1K1H03B	X7R	250	1500pF	± 10%	4.0	3.5	5.0	5.0	3.15	1K1	500
	RCER72E222K1K1H03B	X7R	250	2200pF	± 10%	4.0	3.5	5.0	5.0	3.15	1K1	500
	RCER72E332K1K1H03B	X7R	250	3300pF	± 10%	4.0	3.5	5.0	5.0	3.15	1K1	500
	RCER72E472K1K1H03B	X7R	250	4700pF	± 10%	4.0	3.5	5.0	5.0	3.15	1K1	500
	RCER72E682K1K1H03B	X7R	250	6800pF	± 10%	4.0	3.5	5.0	5.0	3.15	1K1	500
	RCER72E103K1K1H03B	X7R	250	10000pF	± 10%	4.0	3.5	5.0	5.0	3.15	1K1	500
	RCER72E153K1K1H03B	X7R	250	15000pF	± 10%	4.0	3.5	5.0	5.0	3.15	1K1	500
	RCER72E223K1K1H03B	X7R	250	22000pF	± 10%	4.0	3.5	5.0	5.0	3.15	1K1	500
	RCER72E333K2K1H03B	X7R	250	33000pF	± 10%	5.5	4.0	6.0	5.0	3.15	2K1	500
	RCER72E473K2K1H03B	X7R	250	47000pF	± 10%	5.5	4.0	6.0	5.0	3.15	2K1	500
	RCER72E683K2K1H03B	X7R	250	68000pF	± 10%	5.5	4.0	6.0	5.0	3.15	2K1	500
	RCER72E104K2K1H03B	X7R	250	0.10μF	± 10%	5.5	4.0	6.0	5.0	3.15	2K1	500
	RCER72E154K3K1H03B	X7R	250	0.15μF	± 10%	5.5	5.0	7.5	5.0	4.0	3K1	500
	RCER72E224K3K1H03B	X7R	250	0.22μF	± 10%	5.5	5.0	7.5	5.0	4.0	3K1	500
	RCER72E334K4K1H03B	X7R	250	0.33μF	± 10%	7.5	5.5	8.0	5.0	4.0	4K1	500
	RCER72E474K4K1H03B	X7R	250	0.47μF	± 10%	7.5	5.5	8.0	5.0	4.0	4K1	500
	RCER72E684K5B1H03B	X7R	250	0.68μF	± 10%	7.5	7.5	-	5.0	4.0	5B1	500
	RCER72E105K5B1H03B	X7R	250	1.0μF	± 10%	7.5	7.5	-	5.0	4.0	5B1	500
	RCER72E225MUB1H03B	X7R	250	2.2μF	± 20%	7.7	12.5	-	5.0	4.0	UB1	200
	RCER72J102K2K1H03B	X7R	630	1000pF	± 10%	5.5	4.0	6.0	5.0	3.15	2K1	500
	RCER72J152K2K1H03B	X7R	630	1500pF	± 10%	5.5	4.0	6.0	5.0	3.15	2K1	500
	RCER72J222K2K1H03B	X7R	630	2200pF	± 10%	5.5	4.0	6.0	5.0	3.15	2K1	500
	RCER72J332K2K1H03B	X7R	630	3300pF	± 10%	5.5	4.0	6.0	5.0	3.15	2K1	500
	RCER72J472K2K1H03B	X7R	630	4700pF	± 10%	5.5	4.0	6.0	5.0	3.15	2K1	500
	RCER72J682K2K1H03B	X7R	630	6800pF	± 10%	5.5	4.0	6.0	5.0	3.15	2K1	500
	RCER72J103K2K1H03B	X7R	630	10000pF	± 10%	5.5	4.0	6.0	5.0	3.15	2K1	500
	RCER72J153K2K1H03B	X7R	630	15000pF	± 10%	5.5	4.0	6.0	5.0	3.15	2K1	500
	RCER72J223K2K1H03B	X7R	630	22000pF	± 10%	5.5	4.0	6.0	5.0	3.15	2K1	500
	RCER72J333K3K1H03B	X7R	630	33000pF	± 10%	5.5	5.0	7.5	5.0	4.0	3K1	500
	RCER72J473K3K1H03B	X7R	630	47000pF	± 10%	5.5	5.0	7.5	5.0	4.0	3K1	500
	RCER72J683K4K1H03B	X7R	630	68000pF	± 10%	7.5	5.5	8.0	5.0	4.0	4K1	500
	RCER72J104K4K1H03B	X7R	630	0.10μF	± 10%	7.5	5.5	8.0	5.0	4.0	4K1	500
	RCER72J154K5B1H03B	X7R	630	0.15μF	± 10%	7.5	8.0	-	5.0	4.0	5B1	500
	RCER72J224K5B1H03B	X7R	630	0.22μF	± 10%	7.5	8.0	-	5.0	4.0	5B1	500
	RCER72J474MUB1H03B	X7R	630	0.47μF	± 20%	7.7	13.0	-	5.0	4.0	UB1	200

Reference only

• Inside Crimp
(Lead Code: K1)

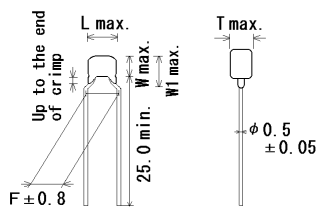

• Straight Long
(Lead Code: B1)

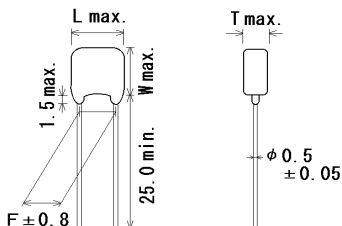

• Straight Long
(Size Lead Code: UB1)

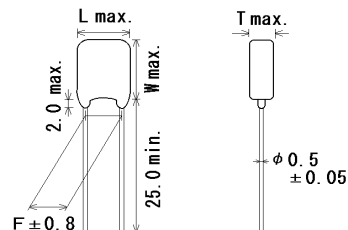

Unit : mm

Customer Part Number	Murata Part Number	T.C.	DC Rated Volt. (V)	Cap.	Cap. tol.	Dimension (mm)					Size Lead Code	Pack qty. (pcs)
						L	W	W1	F	T		
	RCER73A102K2K1H03B	X7R	1000	1000pF	±10%	5.5	4.0	6.0	5.0	3.15	2K1	500
	RCER73A152K2K1H03B	X7R	1000	1500pF	±10%	5.5	4.0	6.0	5.0	3.15	2K1	500
	RCER73A222K2K1H03B	X7R	1000	2200pF	±10%	5.5	4.0	6.0	5.0	3.15	2K1	500
	RCER73A332K2K1H03B	X7R	1000	3300pF	±10%	5.5	4.0	6.0	5.0	3.15	2K1	500
	RCER73A472K2K1H03B	X7R	1000	4700pF	±10%	5.5	4.0	6.0	5.0	3.15	2K1	500
	RCER73A682K2K1H03B	X7R	1000	6800pF	±10%	5.5	4.0	6.0	5.0	3.15	2K1	500
	RCER73A103K2K1H03B	X7R	1000	10000pF	±10%	5.5	4.0	6.0	5.0	3.15	2K1	500
	RCER73A153K3K1H03B	X7R	1000	15000pF	±10%	5.5	5.0	7.5	5.0	4.0	3K1	500
	RCER73A223K3K1H03B	X7R	1000	22000pF	±10%	5.5	5.0	7.5	5.0	4.0	3K1	500
	RCER73A333K4K1H03B	X7R	1000	33000pF	±10%	7.5	5.5	8.0	5.0	4.0	4K1	500
	RCER73A473K4K1H03B	X7R	1000	47000pF	±10%	7.5	5.5	8.0	5.0	4.0	4K1	500
	RCER73A683K5B1H03B	X7R	1000	68000pF	±10%	7.5	8.0	-	5.0	4.0	5B1	500
	RCER73A104K5B1H03B	X7R	1000	0.10μF	±10%	7.5	8.0	-	5.0	4.0	5B1	500
	RCER73A224MUB1H03B	X7R	1000	0.22μF	±20%	7.7	13.0	-	5.0	4.0	UB1	200

Reference only

• Inside Crimp Taping
(Lead Code: M*)

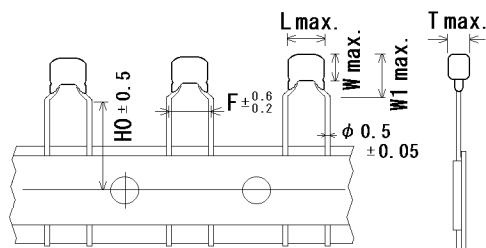

• Straight Taping
(Lead Code: E*)

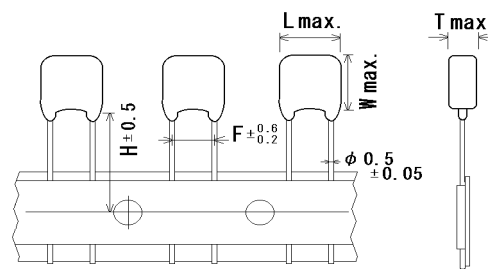

Unit : mm

Customer Part Number	Murata Part Number	T.C.	DC Rated volt. (V)	Cap.	Cap. tol.	Dimension (mm)						Size Lead Code	Pack qty. (pcs)
						L	W	W1	F	T	H0		
	RCER72E102K1M1H03A	X7R	250	1000pF	±10%	4.0	3.5	5.0	5.0	3.15	16.0	1M1	2000
	RCER72E152K1M1H03A	X7R	250	1500pF	±10%	4.0	3.5	5.0	5.0	3.15	16.0	1M1	2000
	RCER72E222K1M1H03A	X7R	250	2200pF	±10%	4.0	3.5	5.0	5.0	3.15	16.0	1M1	2000
	RCER72E332K1M1H03A	X7R	250	3300pF	±10%	4.0	3.5	5.0	5.0	3.15	16.0	1M1	2000
	RCER72E472K1M1H03A	X7R	250	4700pF	±10%	4.0	3.5	5.0	5.0	3.15	16.0	1M1	2000
	RCER72E682K1M1H03A	X7R	250	6800pF	±10%	4.0	3.5	5.0	5.0	3.15	16.0	1M1	2000
	RCER72E103K1M1H03A	X7R	250	10000pF	±10%	4.0	3.5	5.0	5.0	3.15	16.0	1M1	2000
	RCER72E153K1M1H03A	X7R	250	15000pF	±10%	4.0	3.5	5.0	5.0	3.15	16.0	1M1	2000
	RCER72E223K1M1H03A	X7R	250	22000pF	±10%	4.0	3.5	5.0	5.0	3.15	16.0	1M1	2000
	RCER72E333K2M1H03A	X7R	250	33000pF	±10%	5.5	4.0	6.0	5.0	3.15	16.0	2M1	2000
	RCER72E473K2M1H03A	X7R	250	47000pF	±10%	5.5	4.0	6.0	5.0	3.15	16.0	2M1	2000
	RCER72E683K2M1H03A	X7R	250	68000pF	±10%	5.5	4.0	6.0	5.0	3.15	16.0	2M1	2000
	RCER72E104K2M1H03A	X7R	250	0.10μF	±10%	5.5	4.0	6.0	5.0	3.15	16.0	2M1	2000
	RCER72E154K3M1H03A	X7R	250	0.15μF	±10%	5.5	5.0	7.5	5.0	4.0	16.0	3M1	2000
	RCER72E224K3M1H03A	X7R	250	0.22μF	±10%	5.5	5.0	7.5	5.0	4.0	16.0	3M1	2000
	RCER72E334K4M1H03A	X7R	250	0.33μF	±10%	7.5	5.5	8.0	5.0	4.0	16.0	4M1	1500
	RCER72E474K4M1H03A	X7R	250	0.47μF	±10%	7.5	5.5	8.0	5.0	4.0	16.0	4M1	1500
	RCER72E684K5E1H03A	X7R	250	0.68μF	±10%	7.5	7.5	-	5.0	4.0	17.5	5E1	1500
	RCER72E105K5E1H03A	X7R	250	1.0μF	±10%	7.5	7.5	-	5.0	4.0	17.5	5E1	1500
	RCER72E225MUE1H03A	X7R	250	2.2μF	±20%	7.7	12.5	-	5.0	4.0	17.5	UE1	1500
	RCER72J102K2M1H03A	X7R	630	1000pF	±10%	5.5	4.0	6.0	5.0	3.15	16.0	2M1	2000
	RCER72J152K2M1H03A	X7R	630	1500pF	±10%	5.5	4.0	6.0	5.0	3.15	16.0	2M1	2000
	RCER72J222K2M1H03A	X7R	630	2200pF	±10%	5.5	4.0	6.0	5.0	3.15	16.0	2M1	2000
	RCER72J332K2M1H03A	X7R	630	3300pF	±10%	5.5	4.0	6.0	5.0	3.15	16.0	2M1	2000
	RCER72J472K2M1H03A	X7R	630	4700pF	±10%	5.5	4.0	6.0	5.0	3.15	16.0	2M1	2000
	RCER72J682K2M1H03A	X7R	630	6800pF	±10%	5.5	4.0	6.0	5.0	3.15	16.0	2M1	2000
	RCER72J103K2M1H03A	X7R	630	10000pF	±10%	5.5	4.0	6.0	5.0	3.15	16.0	2M1	2000
	RCER72J153K2M1H03A	X7R	630	15000pF	±10%	5.5	4.0	6.0	5.0	3.15	16.0	2M1	2000
	RCER72J223K2M1H03A	X7R	630	22000pF	±10%	5.5	4.0	6.0	5.0	3.15	16.0	2M1	2000
	RCER72J333K3M1H03A	X7R	630	33000pF	±10%	5.5	5.0	7.5	5.0	4.0	16.0	3M1	2000
	RCER72J473K3M1H03A	X7R	630	47000pF	±10%	5.5	5.0	7.5	5.0	4.0	16.0	3M1	2000
	RCER72J683K4M1H03A	X7R	630	68000pF	±10%	7.5	5.5	8.0	5.0	4.0	16.0	4M1	1500
	RCER72J104K4M1H03A	X7R	630	0.10μF	±10%	7.5	5.5	8.0	5.0	4.0	16.0	4M1	1500
	RCER72J154K5E1H03A	X7R	630	0.15μF	±10%	7.5	8.0	-	5.0	4.0	17.5	5E1	1500
	RCER72J224K5E1H03A	X7R	630	0.22μF	±10%	7.5	8.0	-	5.0	4.0	17.5	5E1	1500
	RCER72J474MUE1H03A	X7R	630	0.47μF	±20%	7.7	13.0	-	5.0	4.0	17.5	UE1	1500

Reference only

• Inside Crimp Taping
(Lead Code: M*)

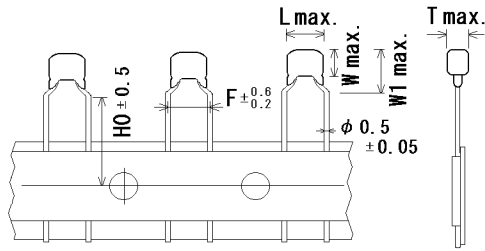

• Straight Taping
(Lead Code: E*)

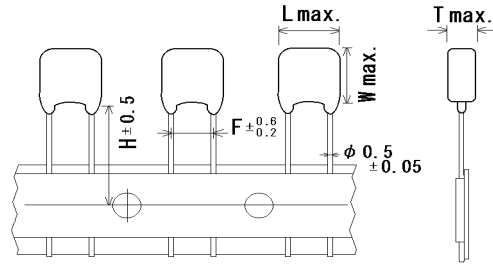

Unit : mm

Customer Part Number	Murata Part Number	T.C.	DC Rated volt. (V)	Cap.	Cap. tol.	Dimension (mm)						Size Lead Code	Pack qty. (pcs)
						L	W	W1	F	T	H0		
	RCER73A102K2M1H03A	X7R	1000	1000pF	±10%	5.5	4.0	6.0	5.0	3.15	16.0	2M1	2000
	RCER73A152K2M1H03A	X7R	1000	1500pF	±10%	5.5	4.0	6.0	5.0	3.15	16.0	2M1	2000
	RCER73A222K2M1H03A	X7R	1000	2200pF	±10%	5.5	4.0	6.0	5.0	3.15	16.0	2M1	2000
	RCER73A332K2M1H03A	X7R	1000	3300pF	±10%	5.5	4.0	6.0	5.0	3.15	16.0	2M1	2000
	RCER73A472K2M1H03A	X7R	1000	4700pF	±10%	5.5	4.0	6.0	5.0	3.15	16.0	2M1	2000
	RCER73A682K2M1H03A	X7R	1000	6800pF	±10%	5.5	4.0	6.0	5.0	3.15	16.0	2M1	2000
	RCER73A103K2M1H03A	X7R	1000	10000pF	±10%	5.5	4.0	6.0	5.0	3.15	16.0	2M1	2000
	RCER73A153K3M1H03A	X7R	1000	15000pF	±10%	5.5	5.0	7.5	5.0	4.0	16.0	3M1	2000
	RCER73A223K3M1H03A	X7R	1000	22000pF	±10%	5.5	5.0	7.5	5.0	4.0	16.0	3M1	2000
	RCER73A333K4M1H03A	X7R	1000	33000pF	±10%	7.5	5.5	8.0	5.0	4.0	16.0	4M1	1500
	RCER73A473K4M1H03A	X7R	1000	47000pF	±10%	7.5	5.5	8.0	5.0	4.0	16.0	4M1	1500
	RCER73A683K5E1H03A	X7R	1000	68000pF	±10%	7.5	8.0	-	5.0	4.0	17.5	5E1	1500
	RCER73A104K5E1H03A	X7R	1000	0.10μF	±10%	7.5	8.0	-	5.0	4.0	17.5	5E1	1500
	RCER73A224MUE1H03A	X7R	1000	0.22μF	±20%	7.7	13.0	-	5.0	4.0	17.5	UE1	1500

Reference only

5. AEC-Q200 Murata Standard Specifications and Test Methods					
No.	AEC-Q200 Test Item	Specification	AEC-Q200 Test Method		
1	Pre-and Post-Stress Electrical Test	-			
2	High Temperature Exposure (Storage)	Appearance	No defects or abnormalities		
		Capacitance Change	within $\pm 12.5\%$		
		D.F.	0.04 max.		
		I.R.	More than $1,000M\Omega$ or $50 M\Omega \cdot \mu F$ (Whichever is smaller)		
3	Temperature Cycling	Appearance	No defects or abnormalities		
		Capacitance Change	within $\pm 12.5\%$		
		D.F.	0.05 max.		
		I.R.	$1,000M\Omega$ or $50M\Omega \cdot \mu F$ min. (Whichever is smaller)		
Step	1	2	3	4	
Temp. ($^\circ C$)	$-55+0/-3$	Room Temp.	$125+3/-0$	Room Temp.	
Time (min.)	15 ± 3	1	15 ± 3	1	
4	Moisture Resistance	Appearance	No defects or abnormalities		
		Capacitance Change	within $\pm 12.5\%$		
		D.F.	0.05 max.		
		I.R.	$500M\Omega$ or $25M\Omega \cdot \mu F$ min. (Whichever is smaller)		
Temperature ($^\circ C$)	Humidity 90-98%	Humidity 80-98%	Humidity 90-98%	Humidity 80-98%	Humidity 90-98%
70	↙	↘	↙	↘	↙
65		↘		↘	
60		↘		↘	
55		↘		↘	
50		↘		↘	
45		↘		↘	
40		↘		↘	
35		↘		↘	
30		↘		↘	
25		↘		↘	
20		↘		↘	
15		↘		↘	
10		↘		↘	
5		↘		↘	
0		↘		↘	
-5		↘		↘	
-10		↘		↘	
5	Biased Humidity	Appearance	No defects or abnormalities		
		Capacitance Change	within $\pm 12.5\%$		
		D.F.	0.05 max.		
		I.R.	$500M\Omega$ or $25M\Omega \cdot \mu F$ min. (Whichever is smaller)		
6	Operational Life	Appearance	No defects or abnormalities		
		Capacitance Change	within $\pm 12.5\%$		
		D.F.	0.04 max.		
		I.R.	$1,000M\Omega$ or $50M\Omega \cdot \mu F$ min. (Whichever is smaller)		
Rated Voltage	Test Voltage				
DC250V	150% of the rated voltage				
DC630V	120% of the rated voltage				
DC1000V	110% of the rated voltage				
7	External Visual	No defects or abnormalities	Visual inspection		
8	Physical Dimension	Within the specified dimensions	Using calipers and micrometers.		
9	Marking	To be easily legible.	Visual inspection		

* "room condition" Temperature: 15 to $35^\circ C$, Relative humidity: 45 to 75% , Atmosphere pressure: 86 to $106kPa$

Reference only

No.	AEC-Q200 Test Item	Specification	AEC-Q200 Test Method									
10	Resistance to Solvents	Appearance	Per MIL-STD-202 Method 215 Solvent 1 : 1 part (by volume) of isopropyl alcohol 3 parts (by volume) of mineral spirits Solvent 2 : Terpene defluxer Solvent 3 : 42 parts (by volume) of water 1part (by volume) of propylene glycol monomethyl ether 1 part (by volume) of monoethanolamine									
		Capacitance										
		D.F.										
		I.R.										
11	Mechanical Shock	Appearance	Three shocks in each direction should be applied along 3 mutually perpendicular axes of the test specimen (18 shocks). The specified test pulse should be Half-sine and should have a duration :0.5ms, peak value:1,500G and velocity change: 4.7m/s.									
		Capacitance										
		D.F.										
		I.R.										
12	Vibration	Appearance	The capacitor should be subjected to a simple harmonic motion having a total amplitude of 1.5mm, the frequency being varied uniformly between the approximate limits of 10 and 2,000Hz. The frequency range, from 10 to 2,000Hz and return to 10Hz, should be traversed in approximately 20 min. This motion should be applied for 12 items in each 3 mutually perpendicular directions (total of 36 times).									
		Capacitance										
		D.F.										
		I.R.										
13-1	Resistance to Soldering Heat (Non-Preheat)	Appearance	The lead wires should be immersed in the melted solder 1.5 to 2.0mm from the root of terminal at 260±5°C for 10±1 seconds. • Pre-treatment Capacitor should be stored at 150+0/-10°C for one hour, then place at *room condition for 24±2 hours before initial measurement. • Post-treatment Capacitor should be stored for 24±2 hours at *room condition.									
		Capacitance Change										
		Dielectric Strength (Between terminals)										
		I.R.										
13-2	Resistance to Soldering Heat (On-Preheat)	Appearance	First the capacitor should be stored at 120+0/-5°C for 60+0/-5 seconds. Then, the lead wires should be immersed in the melted solder 1.5 to 2.0mm from the root of terminal at 260±5°C for 7.5+0/-1 seconds. • Pre-treatment Capacitor should be stored at 150+0/-10°C for one hour, then place at *room condition for 24±2 hours before initial measurement. • Post-treatment Capacitor should be stored for 24±2 hours at *room condition.									
		Capacitance Change										
		Dielectric Strength (Between terminals)										
		I.R.										
13-3	Resistance to Soldering Heat (soldering iron method)	Appearance	Test condition Temperature of iron-tip : 350±10°C Soldering time : 3.5±0.5 seconds Soldering position Straight Lead:1.5 to 2.0mm from the root of terminal. Crimp Lead:1.5 to 2.0mm from the end of lead bend. • Pre-treatment Capacitor should be stored at 150+0/-10°C for one hour, then place at *room condition for 24±2 hours before initial measurement. • Post-treatment Capacitor should be stored for 24±2 hours at *room condition.									
		Capacitance Change										
		Dielectric Strength (Between terminals)										
		I.R.										
14	Thermal Shock	Appearance	Perform the 300 cycles according to the two heat treatments listed in the following table(Maximum transfer time is 20s.). Let sit for 24±2 h at *room condition, then measure. <table border="1" style="margin-left: 20px;"> <thead> <tr> <th>Step</th> <th>1</th> <th>2</th> </tr> </thead> <tbody> <tr> <td>Temp. (°C)</td> <td>-55+0/-3</td> <td>125+3/-0</td> </tr> <tr> <td>Time (min.)</td> <td>15±3</td> <td>15±3</td> </tr> </tbody> </table> • Pretreatment Perform the heat treatment at 150+0/-10°C for 60±5 min and then let sit for 24±2 h at *room condition.	Step	1	2	Temp. (°C)	-55+0/-3	125+3/-0	Time (min.)	15±3	15±3
		Step		1	2							
		Temp. (°C)		-55+0/-3	125+3/-0							
		Time (min.)		15±3	15±3							
Capacitance Change												
D.F.												
I.R.												
15	ESD	Appearance	Per AEC-Q200-002									
		Capacitance										
		D.F.										
		I.R.										

* "room condition" Temperature:15 to 35°C, Relative humidity:45 to 75%, Atmosphere pressure:86 to 106kPa

Reference only

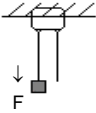
No.	AEC-Q200 Test Item	Specifications	AEC-Q200 Test Method												
16	Solderability	Lead wire should be soldered with uniform coating on the axial direction over 95% of the circumferential direction.	Should be placed into steam aging for 8h±15 min. The terminal of capacitor is dipped into a solution of ethanol (JIS K 8101) and rosin (JIS K 5902) (25% rosin in weight proportion). Immerse in solder solution for 2±0.5 seconds. In both cases the depth of dipping is up to about 1.5 to 2mm from the terminal body. Temp. of solder : 245±5°C Lead Free Solder(Sn-3.0Ag-0.5Cu) 235±5°C H60A or H63A Eutectic Solder												
17	Electrical Characterization	Appearance	No defects or abnormalities												
		Capacitance	Within the specified tolerance												
		D.F.	0.025 max.												
		I.R.	Between Terminals 10,000MΩ or 100MΩ·μF min. (Whichever is smaller)												
		Dielectric Strength	Between Terminals	No defects or abnormalities											
Body Insulation	No defects or abnormalities														
			Visual inspection. The capacitance/D.F. should be measured at 25°C at the frequency and voltage shown in the table. <table border="1" style="margin-left: auto; margin-right: auto;"> <tr> <th>Frequency</th> <th>Voltage</th> </tr> <tr> <td>1±0.1kHz</td> <td>1±0.2V(rms)</td> </tr> </table>	Frequency	Voltage	1±0.1kHz	1±0.2V(rms)								
Frequency	Voltage														
1±0.1kHz	1±0.2V(rms)														
			The insulation resistance should be measured with DC500V (DC250V in case of rated voltage : DC250V) at 25 °C within 2 min. of charging.												
			The capacitor should not be damaged when voltage inTable is applied between the terminations for 1 to 5 seconds. (Charge/Discharge current ≤ 50mA.) <table border="1" style="margin-left: auto; margin-right: auto;"> <tr> <th>Rated Voltage</th> <th>Test Voltage</th> </tr> <tr> <td>DC250V</td> <td>200% of the rated voltage</td> </tr> <tr> <td>DC630V</td> <td>150% of the rated voltage</td> </tr> <tr> <td>DC1000V</td> <td>120% of the rated voltage</td> </tr> </table>	Rated Voltage	Test Voltage	DC250V	200% of the rated voltage	DC630V	150% of the rated voltage	DC1000V	120% of the rated voltage				
Rated Voltage	Test Voltage														
DC250V	200% of the rated voltage														
DC630V	150% of the rated voltage														
DC1000V	120% of the rated voltage														
			The capacitor is placed in a container with metal balls of 1mm diameter so that each terminal, short-circuit is kept approximately 2mm from the balls, and 200% of the rated DC voltage(DC1300V in case of rated voltage : DC630V,DC1000V) is impressed for 1 to 5 seconds between capacitor terminals and metal balls. (Charge/Discharge current ≤ 50mA.)												
18	Terminal Strength	Tensile Strength	Termination not to be broken or loosened												
		Bending Strength	Termination not to be broken or loosened												
			As in the figure, fix the capacitor body, apply the force gradually to each lead in the radial direction of the capacitor until reaching 10N and then keep the force applied for 10±1 seconds. 												
			Each lead wire should be subjected to a force of 2.5N and then be bent 90° at the point of egress in one direction. Each wire is then returned to the original position and bent 90° in the opposite direction at the rate of one bend per 2 to 3 seconds.												
19	Capacitance Temperature Characteristics	Within ±15%	The capacitance change should be measured after 5min. at each specified temperature step. <table border="1" style="margin-left: auto; margin-right: auto;"> <tr> <th>Step</th> <th>Temperature(°C)</th> </tr> <tr> <td>1</td> <td>25±2</td> </tr> <tr> <td>2</td> <td>-55±3</td> </tr> <tr> <td>3</td> <td>25±2</td> </tr> <tr> <td>4</td> <td>125±3</td> </tr> <tr> <td>5</td> <td>25±2</td> </tr> </table> <p>The ranges of capacitance change compared with the above 25°C value over the temperature ranges shown in the table should be within the specified ranges.</p> <p>•Pretreatment Perform the heat treatment at 150+0/-10°C for 60±5 min and then let sit for 24±2 h at *room condition. Perform the initial measurement.</p>	Step	Temperature(°C)	1	25±2	2	-55±3	3	25±2	4	125±3	5	25±2
Step	Temperature(°C)														
1	25±2														
2	-55±3														
3	25±2														
4	125±3														
5	25±2														
* "room condition" Temperature:15 to 35°C, Relative humidity:45 to 75%, Atmosphere pressure:86 to 106kPa															

Reference only

6. Packing specification

- Bulk type (Packing style code : B)

The number of packing = $\frac{\text{Packing quantity}}{\text{Packing quantity}} \times n$

The size of packing case and packing way

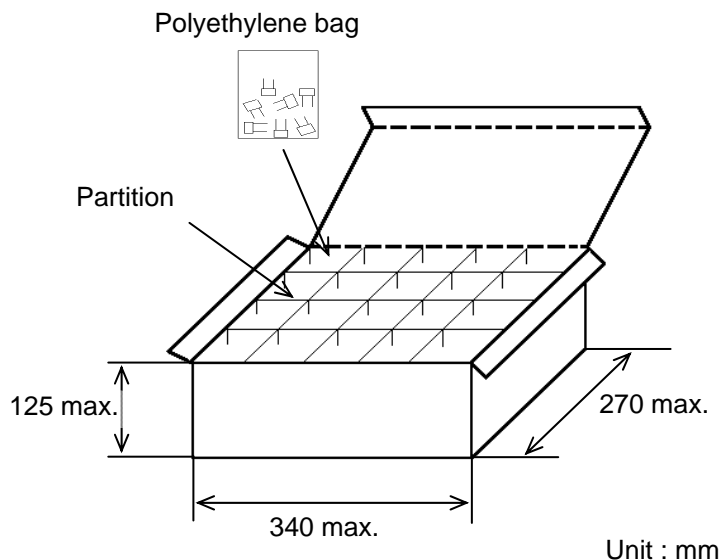

- *1 : Please refer to [Part number list].
- *2 : Standard n = 20 (bag)

Note)
The outer package and the number of outer packing be changed by the order getting amount.

- Ammo pack taping type (Packing style code : A)

- A crease is made every 25 pitches, and the tape with capacitors is packed zigzag into a case.
- When body of the capacitor is piled on other body under it.

The size of packing case and packing way

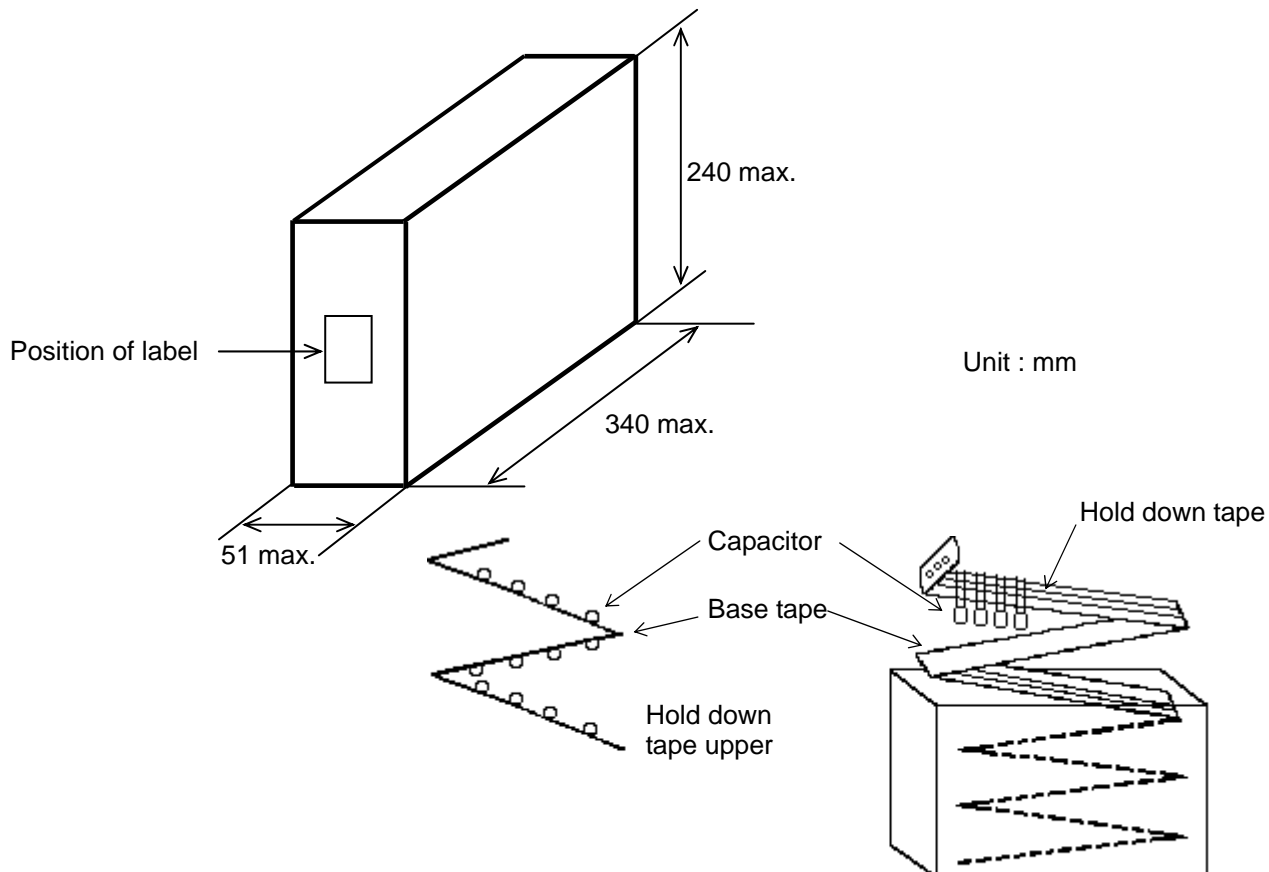

Reference only

7. Taping specification

7-1. Dimension of capacitors on tape

Straight taping type < Lead code : E1 >

Pitch of component 12.7mm / Lead spacing 5.0mm

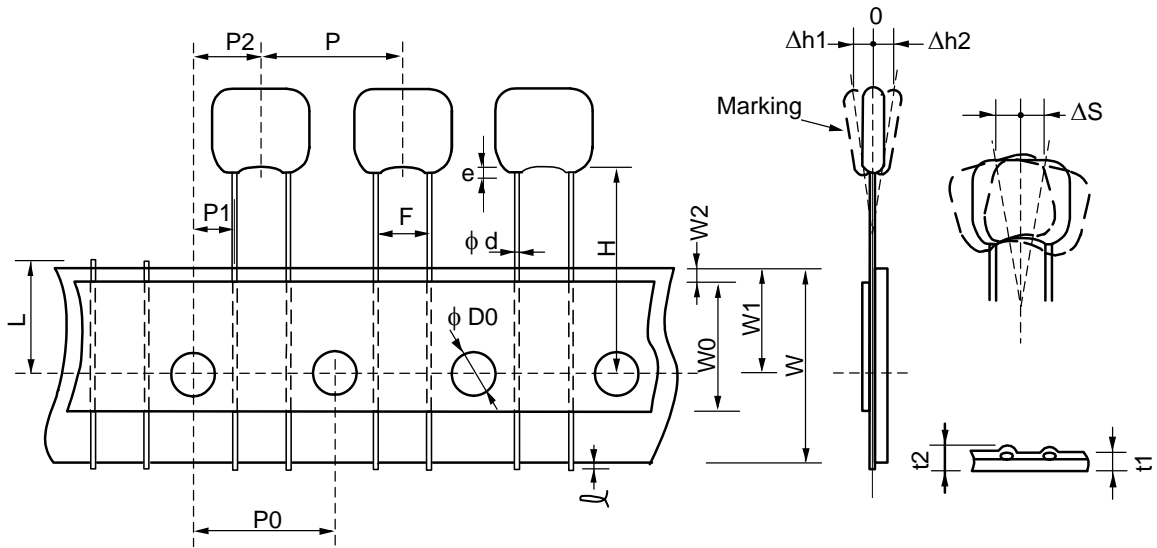

Unit : mm

Item	Code	Dimensions	Remarks
Pitch of component	P	12.7+/-1.0	
Pitch of sprocket hole	P0	12.7+/-0.2	
Lead spacing	F	5.0+0.6/-0.2	
Length from hole center to component center	P2	6.35+/-1.3	Deviation of progress direction
Length from hole center to lead	P1	3.85+/-0.7	
Deviation along tape, left or right defect	ΔS	0+/-2.0	They include deviation by lead bend .
Carrier tape width	W	18.0+/-0.5	
Position of sprocket hole	W1	9.0+0/-0.5	Deviation of tape width direction
For straight lead type	H	17.5+/-0.5	
Protrusion length	l	0.5 max.	
Diameter of sprocket hole	D0	4.0+/-0.1	
Lead diameter	ϕd	0.50+/-0.05	
Total tape thickness	t_1	0.6+/-0.3	They include hold down tape thickness.
Total thickness of tape and lead wire	t_2	1.5 max.	
Deviation across tape	Δh_1	2.0 max. (Dimension code : U)	
	Δh_2	1.0 max. (except as above)	
Portion to cut in case of defect	L	11.0+0/-1.0	
Hold down tape width	W0	9.5 min.	
Hold down tape position	W2	1.5+/-1.5	
Coating extension on lead	e	2.0 max. (Dimension code : U)	
		1.5 max. (except as above)	

Reference only

Inside crimp taping type < Lead code : M1 >
Pitch of component 12.7mm / Lead spacing 5.0mm

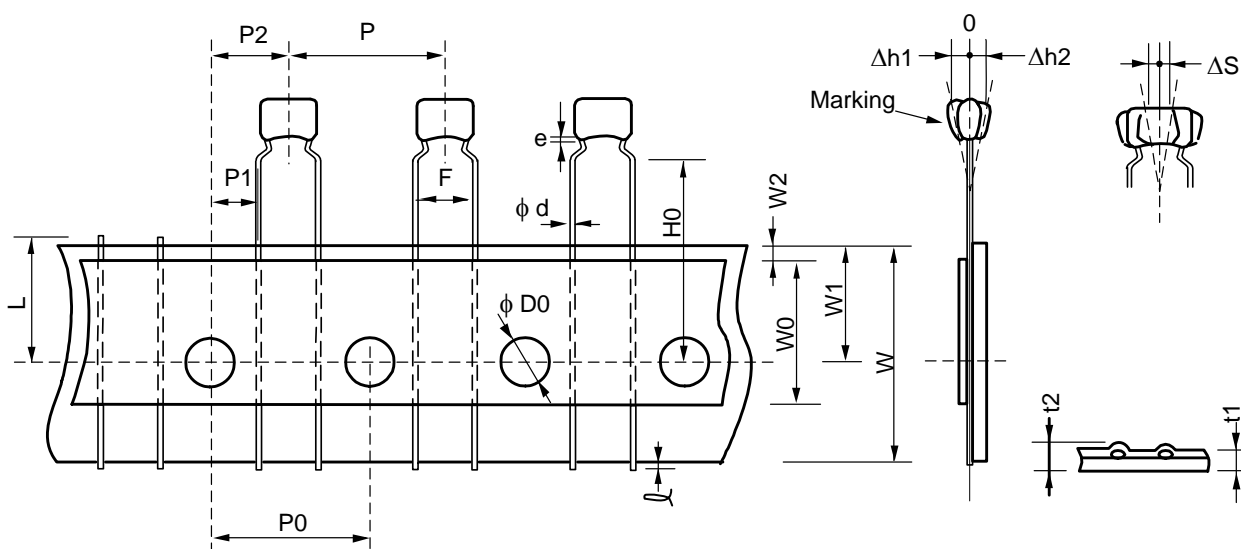

Unit : mm

Item	Code	Dimensions	Remarks
Pitch of component	P	12.7+/-1.0	
Pitch of sprocket hole	P0	12.7+/-0.2	
Lead spacing	F	5.0+0.6/-0.2	
Length from hole center to component center	P2	6.35+/-1.3	Deviation of progress direction
Length from hole center to lead	P1	3.85+/-0.7	
Deviation along tape, left or right defect	ΔS	0+/-2.0	They include deviation by lead bend .
Carrier tape width	W	18.0+/-0.5	
Position of sprocket hole	W1	9.0+0/-0.5	Deviation of tape width direction
Lead distance between reference and bottom plane	H0	16.0+/-0.5	
Protrusion length	ℓ	0.5 max.	
Diameter of sprocket hole	D0	4.0+/-0.1	
Lead diameter	φd	0.50+/-0.05	
Total tape thickness	t1	0.6+/-0.3	They include hold down tape thickness.
Total thickness of tape and lead wire	t2	1.5 max.	
Deviation across tape	Δh1	2.0 max. (Dimension code : W)	
	Δh2	1.0 max. (except as above)	
Portion to cut in case of defect	L	11.0+0/-1.0	
Hold down tape width	W0	9.5 min.	
Hold down tape position	W2	1.5+/-1.5	
Coating extension on lead	e	Up to the end of crimp	

Reference only

7-2. Splicing way of tape

1) Adhesive force of tape is over 3N at test condition as below.

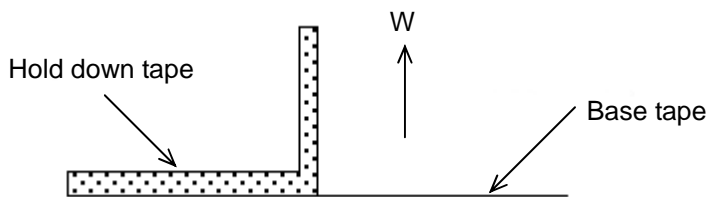

2) Splicing of tape

a) When base tape is spliced

- Base tape shall be spliced by cellophane tape.
(Total tape thickness shall be less than 1.05mm.)

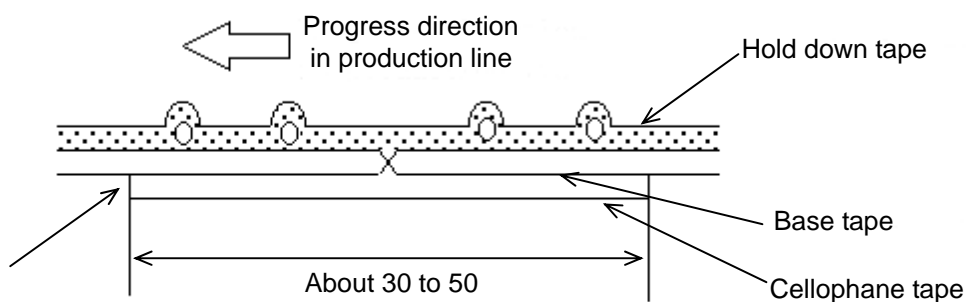

No lifting for the direction of progressing

Unit : mm

b) When hold down tape is spliced

- Hold down tape shall be spliced with overlapping.
(Total tape thickness shall be less than 1.05mm.)

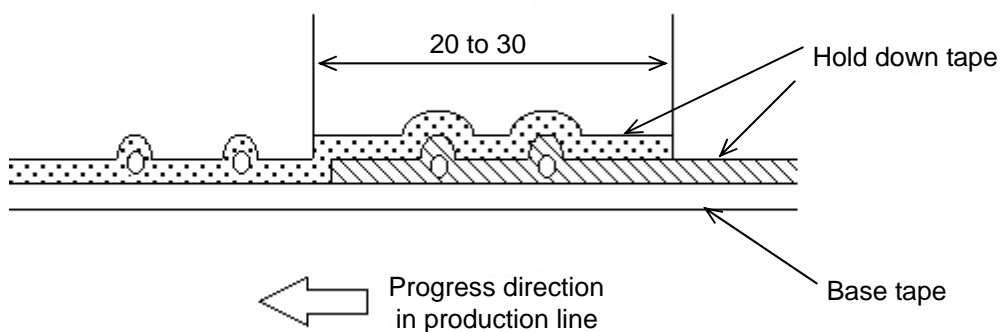

Unit : mm

c) When both tape are spliced

- Base tape and hold down tape shall be spliced with splicing tape.

EU RoHS and Halogen Free

This products of the following crresponds to EU RoHS and Halogen Free

(1) RoHS

EU RoHs 2011/65/EC compliance

maximum concentration values tolerated by weight in homogeneous materials

- 1000 ppm maximum Lead
- 1000 ppm maximum Mercury
- 100 ppm maximum Cadmium
- 1000 ppm maximum Hexavalent chromium
- 1000 ppm maximum Polybrominated biphenyls (PBB)
- 1000 ppm maximum Polybrominated diphenyl ethers (PBDE)

(2) Halogen-Free

The International Electrochemical Commission' s (IEC) Definition of Halogen-Free (IEC 61249-2-21) compliance

- 900 ppm maximum chlorine
- 900 ppm maximum bromine
- 1500 ppm maximum total chlorine and bromine

Mouser Electronics

Authorized Distributor

Click to View Pricing, Inventory, Delivery & Lifecycle Information:

Murata:

[RCER72E102K1K1H03B](#) [RCER72E102K1M1H03A](#) [RCER72E103K1K1H03B](#) [RCER72E103K1M1H03A](#)
[RCER72E104K2K1H03B](#) [RCER72E104K2M1H03A](#) [RCER72E105K5B1H03B](#) [RCER72E105K5E1H03A](#)
[RCER72E152K1K1H03B](#) [RCER72E152K1M1H03A](#) [RCER72E153K1K1H03B](#) [RCER72E153K1M1H03A](#)
[RCER72E154K3K1H03B](#) [RCER72E154K3M1H03A](#) [RCER72E222K1K1H03B](#) [RCER72E222K1M1H03A](#)
[RCER72E223K1K1H03B](#) [RCER72E223K1M1H03A](#) [RCER72E224K3K1H03B](#) [RCER72E224K3M1H03A](#)
[RCER72E225MUB1H03B](#) [RCER72E225MUE1H03A](#) [RCER72E332K1K1H03B](#) [RCER72E332K1M1H03A](#)
[RCER72E333K2K1H03B](#) [RCER72E333K2M1H03A](#) [RCER72E334K4K1H03B](#) [RCER72E334K4M1H03A](#)
[RCER72E472K1K1H03B](#) [RCER72E472K1M1H03A](#) [RCER72E473K2K1H03B](#) [RCER72E473K2M1H03A](#)
[RCER72E474K4K1H03B](#) [RCER72E474K4M1H03A](#) [RCER72E682K1K1H03B](#) [RCER72E682K1M1H03A](#)
[RCER72E683K2K1H03B](#) [RCER72E683K2M1H03A](#) [RCER72E684K5B1H03B](#) [RCER72E684K5E1H03A](#)
[RCER72J102K2K1H03B](#) [RCER72J102K2M1H03A](#) [RCER72J103K2K1H03B](#) [RCER72J103K2M1H03A](#)
[RCER72J104K4K1H03B](#) [RCER72J104K4M1H03A](#) [RCER72J152K2K1H03B](#) [RCER72J152K2M1H03A](#)
[RCER72J153K2K1H03B](#) [RCER72J153K2M1H03A](#) [RCER72J154K5B1H03B](#) [RCER72J154K5E1H03A](#)
[RCER72J222K2K1H03B](#) [RCER72J222K2M1H03A](#) [RCER72J223K2K1H03B](#) [RCER72J223K2M1H03A](#)
[RCER72J224K5B1H03B](#) [RCER72J224K5E1H03A](#) [RCER72J332K2K1H03B](#) [RCER72J332K2M1H03A](#)
[RCER72J333K3K1H03B](#) [RCER72J333K3M1H03A](#) [RCER72J472K2K1H03B](#) [RCER72J472K2M1H03A](#)
[RCER72J473K3K1H03B](#) [RCER72J473K3M1H03A](#) [RCER72J474MUB1H03B](#) [RCER72J474MUE1H03A](#)
[RCER72J682K2K1H03B](#) [RCER72J682K2M1H03A](#) [RCER72J683K4K1H03B](#) [RCER72J683K4M1H03A](#)
[RCER73A102K2K1H03B](#) [RCER73A102K2M1H03A](#) [RCER73A103K2K1H03B](#) [RCER73A103K2M1H03A](#)
[RCER73A104K5B1H03B](#) [RCER73A104K5E1H03A](#) [RCER73A152K2K1H03B](#) [RCER73A152K2M1H03A](#)
[RCER73A153K3K1H03B](#) [RCER73A153K3M1H03A](#) [RCER73A222K2K1H03B](#) [RCER73A222K2M1H03A](#)
[RCER73A223K3K1H03B](#) [RCER73A223K3M1H03A](#) [RCER73A224MUB1H03B](#) [RCER73A224MUE1H03A](#)
[RCER73A332K2K1H03B](#) [RCER73A332K2M1H03A](#) [RCER73A333K4K1H03B](#) [RCER73A333K4M1H03A](#)
[RCER73A472K2K1H03B](#) [RCER73A472K2M1H03A](#) [RCER73A473K4K1H03B](#) [RCER73A473K4M1H03A](#)
[RCER73A682K2K1H03B](#) [RCER73A682K2M1H03A](#) [RCER73A683K5B1H03B](#) [RCER73A683K5E1H03A](#)