

SLC Capacitors

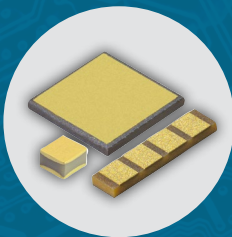

Introduction to Knowles Precision Devices

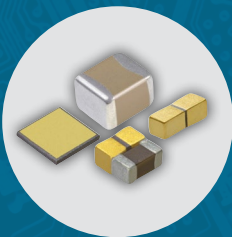
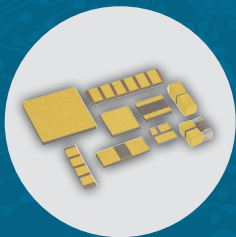
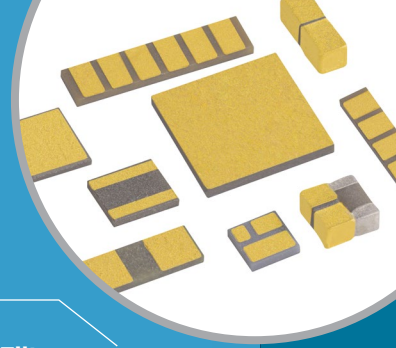

Knowles Precision Devices is a premier global source for Capacitors, RF Filters, EMI Filters, Resonators, non-magnetic components and advanced dielectric materials.

An umbrella for the brands of Compex, DLI, Johanson MFG, Novacap, Syfer and Voltronics, Knowles Precision Devices serves a variety of markets including: military, aerospace/avionics, medical equipment, implantable devices, EMI and connector filtering, oil exploration, instrumentation, industrial electronics, automotive, telecoms and data networks.

| | Trimmer | Multilayer | High Reliability Capacitors | Single Layer Capacitors | RF & Microwave Products |
|------------------------------------|---------|------------|-----------------------------|-------------------------|-------------------------|
| Capacitors: AEC-Q200 | | ● | ● | | |
| Capacitors: Broadband Blocks | | ● | ● | | |
| Capacitors: Cap Assemblies | | ● | ● | | |
| Capacitors: Detonation Pulse | | ● | ● | | |
| Capacitors: High Power | | ● | ● | | |
| Capacitors: High Q | | ● | ● | | |
| Capacitors: High Temperature | | ● | ● | | |
| Capacitors: High Voltage | | ● | ● | | |
| Capacitors: MLC - Leaded | | ● | | | |
| Capacitors: MLC - SMD | | ● | ● | | |
| Capacitors: Non-Magnetic | ● | ● | ● | | |
| Capacitors: Non-Magnetic Leaded | ● | ● | | | |
| Capacitors: Non-Magnetic Trimmers | ● | ● | ● | | |
| Capacitors: Planars and Discoidals | | | ● | | |
| Capacitors: Safety Certified | | ● | ● | | |
| Capacitors: Single Layer | | | ● | ● | |
| Capacitors: Trimmers | ● | ● | | | |
| Dielectric Substrates | | | | ● | |
| EMI Filters | | ● | ● | | |
| Non-Magnetic Hardware | ● | | | | |
| Non-Magnetic Inductors | ● | | | | |
| Microwave Couplers | | | | | ● |
| Microwave Filters | | | | | ● |
| Microwave Power Dividers | | | | | ● |
| Microwave Resonators | | | | | ● |
| Microwave Tuning Elements | ● | | | | ● |
| RF: Gain Equalizers | | | | | ● |
| RF: Bias Filter Networks | | | | | ● |
| RF: Self Bias Networks | | | | | ● |
| Thin Film: Build To Print | | | | | ● |
| Heatsink/Standoff | | | | ● | |
| Mounting Shorts | | | | ● | |

Table of Contents

INTRODUCTION

| | |
|--|---|
| Simplified Frequency & Product Application Chart | 4 |
|--|---|

SINGLE LAYER CAPACITORS DLI

| | |
|------------------------------------|-------|
| SLC — Dielectric Information | 5-6 |
| SLC — Specifications | 7 |
| Packaging | 8 |
| V Series | 9-10 |
| Border Cap® | 11-13 |
| T-Cap® | 14 |
| Di-Cap® | 15-17 |
| Bar Cap® | 18-19 |
| Gap Cap® | 20-22 |
| Bi-Cap® | 23-24 |

SINGLE LAYER CAPACITORS COMPLEX

| | |
|---|-------|
| Materials and Metallization | 25 |
| Typical Temperature Characteristics | 26 |
| CSA Series | 27-29 |
| CSM Series | 30-32 |
| CSB Series | 33-34 |
| CR/CM Series | 35-37 |

SUBSTRATES & HEATSINKS DLI

| | |
|--|-------|
| High-K Ceramic Substrates & Plates | 38-39 |
| SLC — Heatsinks, Standoffs & Submounts | 40-41 |

Substrates & Heatsinks Complex

| | |
|------------------------------------|----|
| SBT Series — Submounts | 42 |
| MST Series — Mounting Shorts | 43 |

BROADBAND DEVICES DLI

| | |
|------------------------------|-------|
| Milli-Cap® | 44-45 |
| Opti-Cap® | 46-47 |
| PX Series | 48-49 |
| MLC — Broadband Blocks | 50 |

RF COMPONENTS DLI

| | |
|---|-------|
| SLC — Gain Equalizers | 51-52 |
| Custom Thin Film: Integrated R-C Networks | 53-54 |
| Our Other Products | 55 |

Simplified Frequency & Product Application Chart

■ DC Blocking
 ■ Low Noise Amplifiers
 ■ Power Amplifiers, High Power Amplifiers
 ■ Oscillators
 ■ Filters

SLC AND THIN FILM

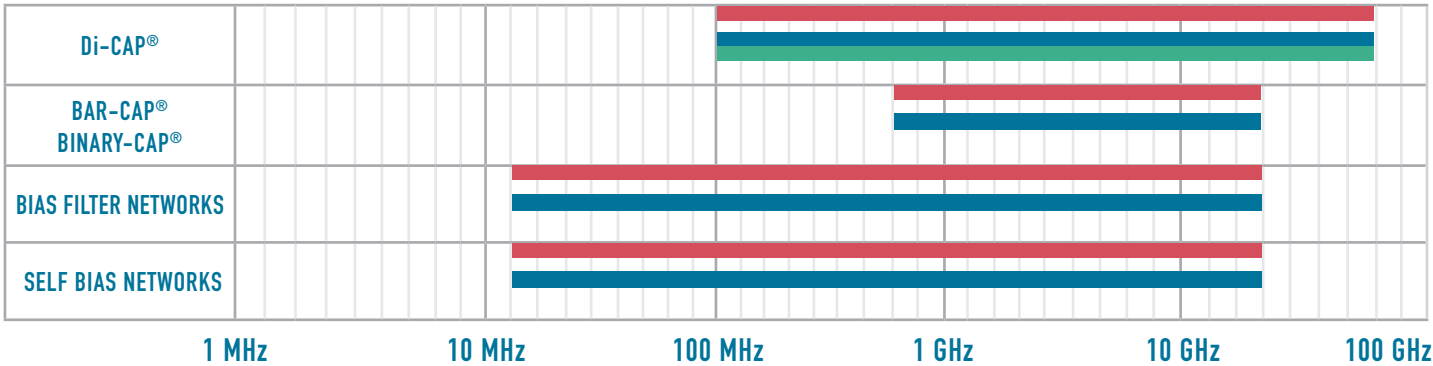

BROADBAND AND DC BLOCKS

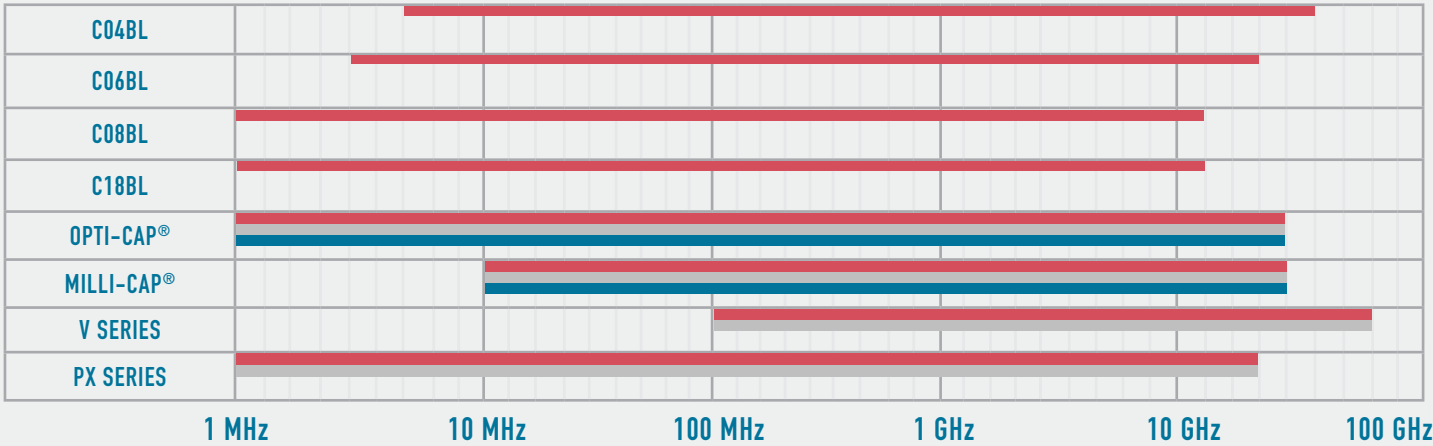

SLC — Dielectric Information

Single Layer Capacitors are available with any of our proprietary dielectric materials in the following configurations:

BORDER CAP®
Di-CAP®

BAR CAP®
Bi-CAP®

GAP CAP®
T-CAP®

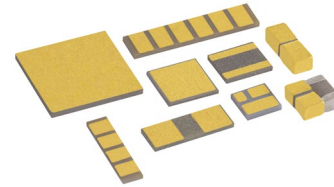

Please consult the following pages for part number identification

DLI CLASS I DIELECTRIC MATERIALS

| Dielectric Code | Relative ϵ_r @ 1 MHz | Temperature Coefficient -55°C to 125°C (ppm/°C Max) | 1 MHz Dissipation Factor (% Maximum) | 25°C Insulation Resistance (M Ω) | 125°C Insulation Resistance (M Ω) |
|-----------------|-------------------------------|--|---|---|--|
| PI | 9.9 | P105 \pm 20 | 0.15 | >10 ⁶ | >10 ⁵ |
| PG | 13 | P22 \pm 30 | 0.15 | >10 ⁶ | >10 ⁵ |
| AH | 20 | P90 \pm 20 | 0.15 | >10 ⁶ | >10 ⁵ |
| CF | 24 | 0 \pm 15 | 0.60 | >10 ⁶ | >10 ⁵ |
| NA | 22 | N30 \pm 15 | 0.15 | >10 ⁶ | >10 ⁵ |
| CD | 37 | N20 \pm 15 | 0.15 | >10 ⁶ | >10 ⁵ |
| NG | 43 | N220 \pm 60 | 0.25 | >10 ⁶ | >10 ⁵ |
| CG | 70 | 0 \pm 30 | 0.70 | >10 ⁶ | >10 ⁵ |
| DB | 72 | N50 \pm 30 | 0.15 | >10 ⁶ | >10 ⁵ |
| NP | 85 | N750 \pm 200 | 0.50 | >10 ⁴ | >10 ³ |
| NR | 160 | N1500 \pm 500 | 0.25 | >10 ⁶ | >10 ⁵ |
| NS | 300 | N2400 \pm 500 | 0.70 | >10 ⁶ | >10 ⁵ |
| NU | 600 | N3700 \pm 1000 | 1.50 | >10 ⁶ | >10 ⁵ |
| NV | 900 | N4700 \pm 1000 | 1.20 | >10 ⁶ | >10 ⁵ |

DLI CLASS II DIELECTRIC MATERIALS

| Dielectric Code | Relative ϵ_r @ 1 MHz | Temperature Coefficient -55°C to 125°C (ppm/°C Max) | | 1 MHz Dissipation Factor (% Maximum) | 25°C Insulation Resistance (M Ω) | 125°C Insulation Resistance (M Ω) |
|-----------------|-------------------------------|---|-----------------------------------|---|---|--|
| | | No Bias, Pre Voltage Conditioning | No Bias, Pre Voltage Conditioning | | | |
| BF* | 445 | \pm 7.5 | \pm 10 | 2.5 | >10 ⁴ | >10 ² |
| BD | 700 | \pm 10 | \pm 15 | 2.5 | >10 ⁴ | >10 ³ |
| BG* | 900 | \pm 10 | \pm 15 | 2.5 | >10 ⁴ | >10 ³ |
| BC | 1300 | \pm 10 | \pm 15 | 2.5 | >10 ⁴ | >10 ³ |
| BE | 1250 | \pm 10 | \pm 15 | 2.5 | >10 ⁴ | >10 ³ |
| BL | 2000 | \pm 15 | \pm 25 | 2.5 | >10 ⁵ | >10 ⁴ |
| BJ | 3300 | \pm 10 | \pm 15 | 3.0 | >10 ⁵ | >10 ⁴ |
| BN | 4500 | \pm 15 | \pm 25 | 3.0 | >10 ⁵ | >10 ⁴ |
| UX | 25,000 - 35,000 | \pm 15% | \pm 25% | 2.5 | >10 ³ | >10 ² |

DLI CLASS III DIELECTRIC MATERIALS

| | | | | | | |
|-----|--------|----------------------------|----------------------------|-----|------------------|------------------|
| BT* | 4200 | +22, -56% (-55°C to 105°C) | +22, -56% (-55°C to 105°C) | 3.0 | >10 ⁵ | >10 ² |
| BU | 8500 | +22, -82% (10°C to 85°C) | +22, -82% (10°C to 85°C) | 3.0 | >10 ⁵ | >10 ⁴ |
| BV | 13,500 | +22, -82% (10°C to 85°C) | +22, -82% (10°C to 85°C) | 3.0 | >10 ⁵ | >10 ⁴ |

Note: * Recommended for commercial use only. Please contact an inside sales representative for additional information.

SLC — Dielectric Information

DIELECTRIC TEMPERATURE CHARACTERISTICS

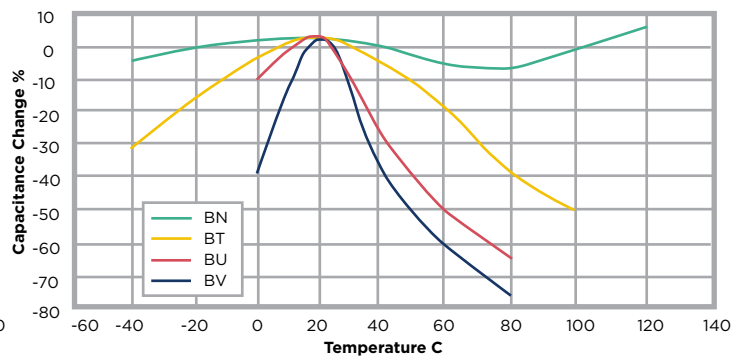
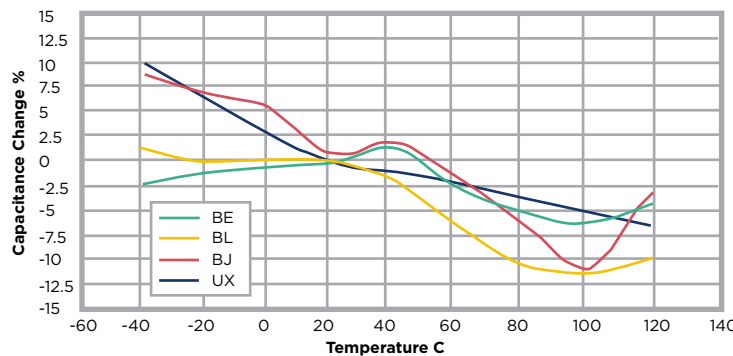
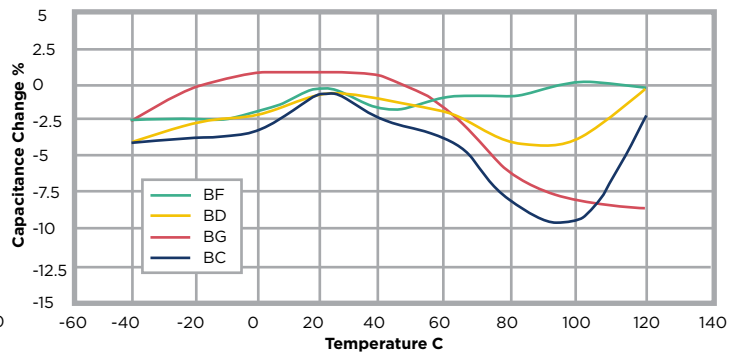
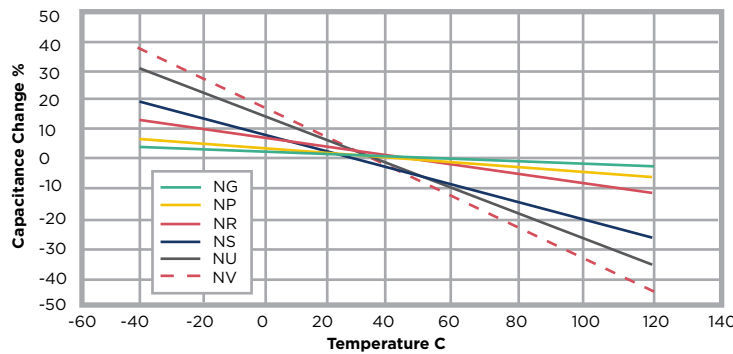
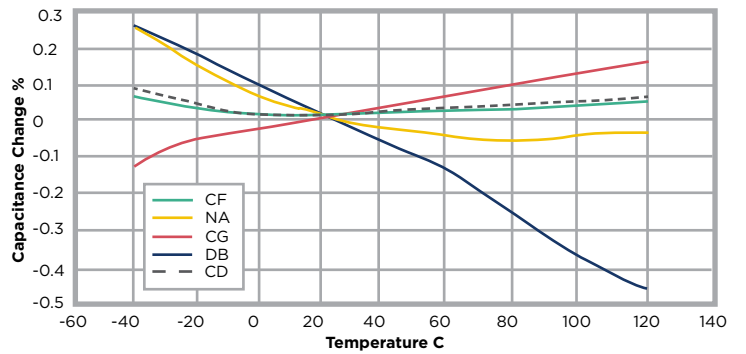
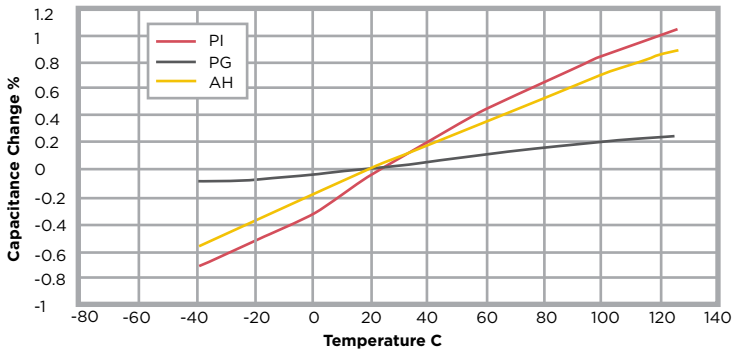



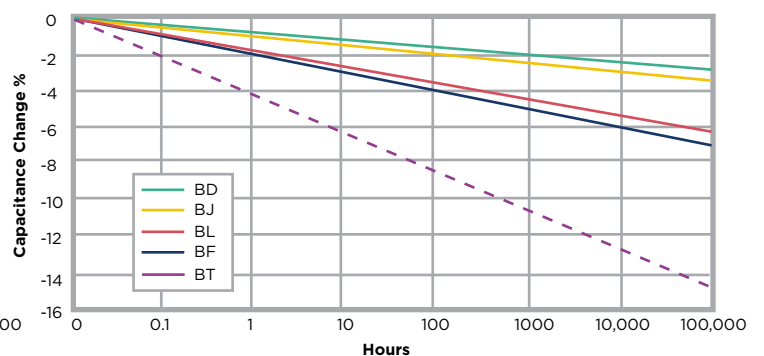
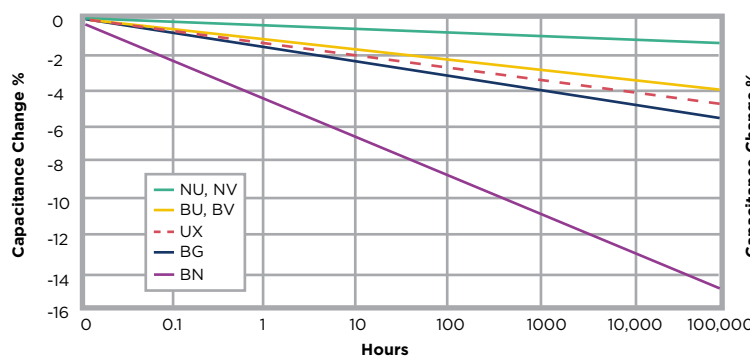





DIELECTRIC AGING CHARACTERISTICS



SLC — Specifications

TERMINATION CODES

| Code | Description (Layers in order from dielectric material to outermost) | Capacitor Types | |
|--|---|--|--|
|  P | S1 (Sputter Plated) 1. 300 Angstroms Titanium-Tungsten 2. 50μ Inches min. Nickel-Vanadium 3. 100μ Inches min. Gold | AU-100 (Wet Plated) 1. 75μ Inches min. Nickel 2. 100μ Inches min. Gold | Di-Cap®, T-Cap®, Bar Cap®, Cinary Cap® and Gap Cap |
|  T | S2 1. 300 Angstroms Titanium-Tungsten 2. 50μ Inches min. Nickel-Vanadium 3. 100μ Inches min. Gold-Tin | | Di-Cap® and T-Cap® |
|  M | S5 1. 300 Angstroms Titanium-Tungsten 2. 100μ Inches min. Gold | | Di-Cap®, T-Cap®, Bar Cap®, Cinary Cap® and Gap Cap |
|  B | S1 | AU-100 | Single Border Cap |
|  E | S1 | AU-100 | Double Border Cap |
|  L | Standard lead material is silver (Ag) .002" thick. Optional Gold (Au) | | Di-Cap® |
|  A | Standard lead material is Silver (Ag) .002" thick. Optional Gold (Au) | | Di-Cap® |
|  Z | Standard lead material is Tin-Copper (Ag,Cu) .002" thick. Optional Gold (Au) | | |
|  S | Standard lead material is silver (Ag) .002" thick. Optional Gold (Au) | | Di-Cap® |

Consult with engineering for solderable metal stacks

TEST LEVEL CODES

| Code | Description |
|--------------------------------------|--|
| Industrial/Commercial Options | |
| X | <ul style="list-style-type: none"> 100% 4 Side Visual Screening 1% AQL for the electrical parameters Capacitance, Dissipation Factor, Insulation Resistance and Dielectric Withstanding Voltage |
| Industrial/Commercial Options | |
| A | MIL-PRF-49464 Group A <ul style="list-style-type: none"> 100% Thermal Shock 100%, 100 +0/-4 Hours Voltage Conditioning 100% Electrical Screening 100% 6 Side Visual Screening Bond Strength Die Shear Strength Temperature Coefficient Limits |
| B | MIL-PRF-49464 Group B <ul style="list-style-type: none"> MIL-PRF-49464, Group A Low Voltage Humidity Immersion Life |
| D | Special agreed upon testing to customers' formal specification. Customer Drawing Required! (May include, but is not limited to, one or more of the following common requests.) <ul style="list-style-type: none"> MIL-PRF-38534 Class H Element Evaluation. MIL-PRF-38534 Class K Element Evaluation. 10(O) Destructive Bond Pull per MIL-STD-883, Method 2011. 10(O) Die Shear per MIL-STD-883, Method 2019. Consult factory for other alternatives or assistance in specifying custom testing. |
| E | 6 Side Visual Screening per MIL-STD-883, Method 2032. |

CAPACITANCE TOLERANCE TABLE

| Tolerance Code | Tolerance |
|----------------|------------|
| A | ±.05pF |
| B | ±.010pF |
| C | ±.25pF |
| D | ±.50pF |
| E | ±.5% |
| F | ± 1% |
| G | ± 2% |
| H | ± 3% |
| I | ± 4% |
| J | ± 5% |
| K | ± 10% |
| L | ± 15% |
| M | ± 20% |
| X | GMV |
| V | +100%, -0% |
| Z | +80%, -20% |
| S | Special |

ENVIRONMENTAL & PHYSICAL TESTING PROCEDURES

| Parameter | Method | MIL-STD-202 Condition |
|---------------------------|--------|--------------------------------|
| Thermal Shock | 107 | A, (modified), -55°C to +125°C |
| Immersion | 104 | B |
| Moisture Resistance | 106 | - |
| Resistance to Solder Heat | 210 | C, 260°C for 20 seconds |
| Life | 108 | A, 96 Hours @ +125°C. |
| Barometric Pressure | 105 | B |
| Shock, (Specified Pulse) | 213 | I, 100g's, 6ms. |
| Vibration, High Frequency | 204 | G, 30g's peak, 10Hz to 2kHz. |

| Parameter | Method | MIL-STD-202 Condition |
|-----------------------|--------|--------------------------------------|
| Bond Strength | 2011 | D, 3 grams min. with .001 dia wire |
| Die Shear Strength | 2019 | Limit per MIL-STD-883, Figure 2019-4 |
| Temperature Cycling | 1010 | C |
| Mechanical Shock | 2002 | B, Y1, |
| Constant Acceleration | 2001 | 3,000g's Y1 direction |

All Single Layer Capacitors are Lead Free (except Leaded Capacitors) and RoHS compliant.

SLC — Packaging

SLC WAFFLE PACKAGING

DLI offers a wide variety of standard design waffle packs in various materials depending on the application. Typical material offerings are antistatic and gel pack, which can contain up to 400 pieces depending on component dimension. Custom waffle packs are available; please consult the factory for details.

SLC TAPE AND REEL

DLI offers tape and reel packaging solutions for a variety of our single layer capacitor case sizes. Utilizing the latest technology and equipment to provide our customers the highest quality products, our standard SMD tape and reel packaging meets or exceeds EIA standards. Custom tape and reel packaging are available; consult the factory for options.

SLC ON TAPE RING

DLI offers single layer capacitors repopulated on blue membrane tape and photon ring assembly to maximize efficiency and minimize product cost. Used in high volume applications, the repopulated capacitors provide for more efficient component placement and fewer "pick and place" machine change-outs. The repopulated capacitors meet GMV capacitance value, are 100% visually acceptable and can be repopulated in custom shapes and sizes on a 6-inch photon tape ring.

SLC "BLACK DOTTED" ON TAPE RING

DLI offers "black dotted" capacitors on membrane tape and photon ring assembly. For high volume applications utilizing visual recognition, a less expensive alternative is the use of "black dotted" capacitors provided on saw dice membrane tape. The non- "black dotted" capacitors meet GMV capacitance value and a minimum of 75% visually acceptable product is guaranteed.

STORAGE

Single layer ceramic capacitors are solderable for a minimum of 1 year from date of shipment if properly stored in their original packaging. For extended periods, storage in a dry nitrogen environment is recommended. Product supplied on membrane tape and photon ring should be stored in the original container and in an environmentally controlled area where temperature and humidity are maintained. It is recommended not to store the product in direct light as this can negatively impact the adhesion properties of the tape.

HANDLING

Single layer ceramic capacitors should be handled carefully during component transfer or placement, preventing damage to the gold and ceramic surfaces. The capacitors should be handled with precision stainless steel tweezers or a vacuum wand. Contacting the capacitor with bare hands should be avoided as resulting contaminants will affect the performance of the component.

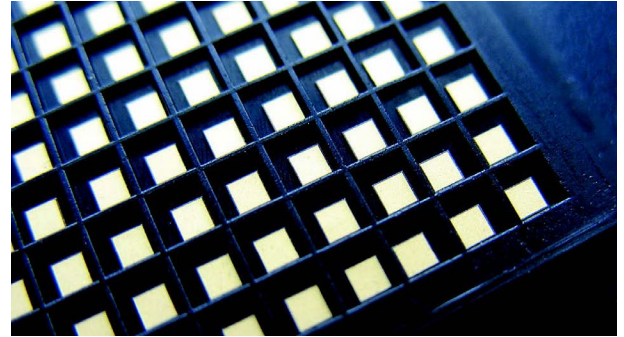

SLC Waffle Packaging



SLC Tape and Reel

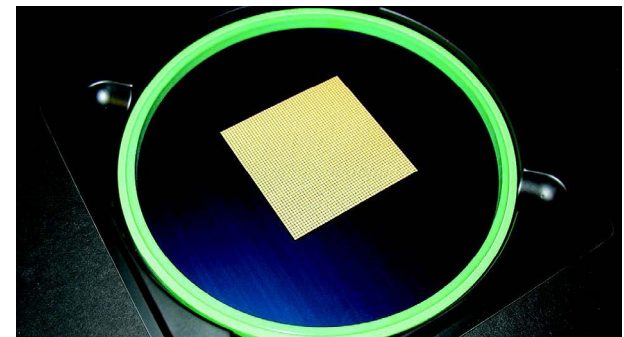

SLC on Tape Ring

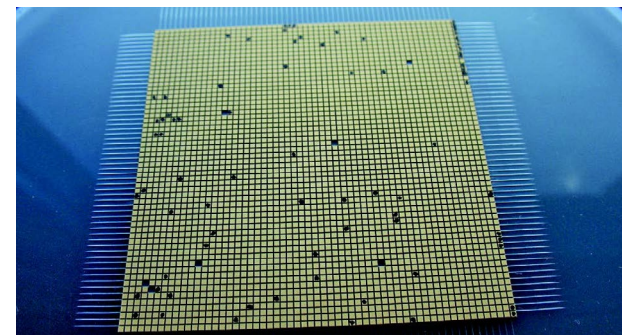

SLC — V Series

DESCRIPTION

Class II dielectric material with X7R characteristics for DC Blocking or RF Bypass applications in a broad frequency range.

These high frequency, wire bondable single layer capacitors are perfect for GaN and GaAs amplifier applications where small size and microwave performance is key to a well-performing circuit.

- X7R Temperature Stability
- Excellent High Frequency Response
- Wire Bondable
- RoHS Compliant
- High Capacitance in a Small Footprint
- MSL-1
- Rated Operating/Storage Temp. -55 to +125°C

FUNCTIONAL APPLICATIONS

- DC Blocking
- RF Bypassing
- Filtering
- Tuning and Coupling



| Part Number | Capacitance | Voltage | Dissipation Factor @ 1MHz | Insulation Resistance | |
|--------------|-------------|---------|---------------------------|-----------------------|--------------------|
| | | | | @ +25C | @+125C |
| V30BZ102M6SX | 1nF ± 20% | 200WVDC | 2.5% | 10 ³ MΩ | 10 ² MΩ |
| V30BZ222M8SX | 2.2nF ± 20% | 150WVDC | 2.5% | 10 ³ MΩ | 10 ² MΩ |
| V30BZ472M1SX | 4.7nF ± 20% | 100WVDC | 2.5% | 10 ³ MΩ | 10 ² MΩ |
| V30BZ682M1SX | 6.8nF ± 20% | 100WVDC | 2.5% | 10 ³ MΩ | 10 ² MΩ |
| V30BZ103M1SX | 10nF ± 20% | 100WVDC | 2.5% | 10 ³ MΩ | 10 ² MΩ |
| V80BZ104M5SX | 100nF ± 20% | 50WVDC | 2.5% | 10 ³ MΩ | 10 ² MΩ |

Metal thickness is min. 100U" of Au over min. 50U" of Ni

| Part Number | Length | Width | Thickness |
|--------------|---|---|---|
| V30BZ102M6SX | 0.030" ± 0.003" (0.762mm ± 0.076mm) | 0.030" ± 0.003" (0.762mm ± 0.076mm) | 0.022" ± 0.003" (0.559mm ± 0.0762mm) |
| V30BZ222M8SX | | | |
| V30BZ472M1SX | | | |
| V30BZ682M1SX | | | |
| V30BZ103M1SX | | | |
| V80BZ104M5SX | 0.084" ± 0.004" (2.134" mm ± 0.102") | 0.042" ± 0.004" (1.067" mm ± 0.102") | 0.024" ± 0.003" (0.610" mm ± 0.076") |

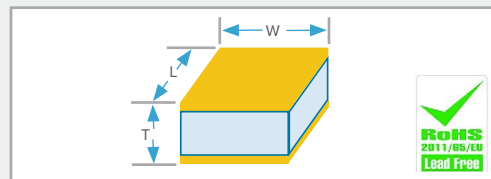

ORDERING INFORMATION — SLC — V SERIES CAPACITORS

| V | 30 | BZ | 102 | M | 5 | S | X | |
|--------------|-----------|--------------------------------|---|-----------|---|-------------|---|----------------------------|
| Product | Case Size | Material | Capacitance (pF) | Tolerance | Voltage | Termination | Test Level | Packaging |
| V = V Series | 30 80 | See material tables on Page 5. | 102 = 1nF 222 = 2.2nF 472 = 4.7nF 682 = 6.8nF 103 = 10nF 104 = 100nF | M = ± 20% | 5 = 50V 1 = 100V 6 = 200V 8 = 150V | S = Au / Ni | X = Commercial A = Group A B = Group B See test level definitions on page 7. | Available in Waffle Packs. |



SLC — V Series

PERFORMANCE CHARACTERISTICS — V SERIES CAPACITORS

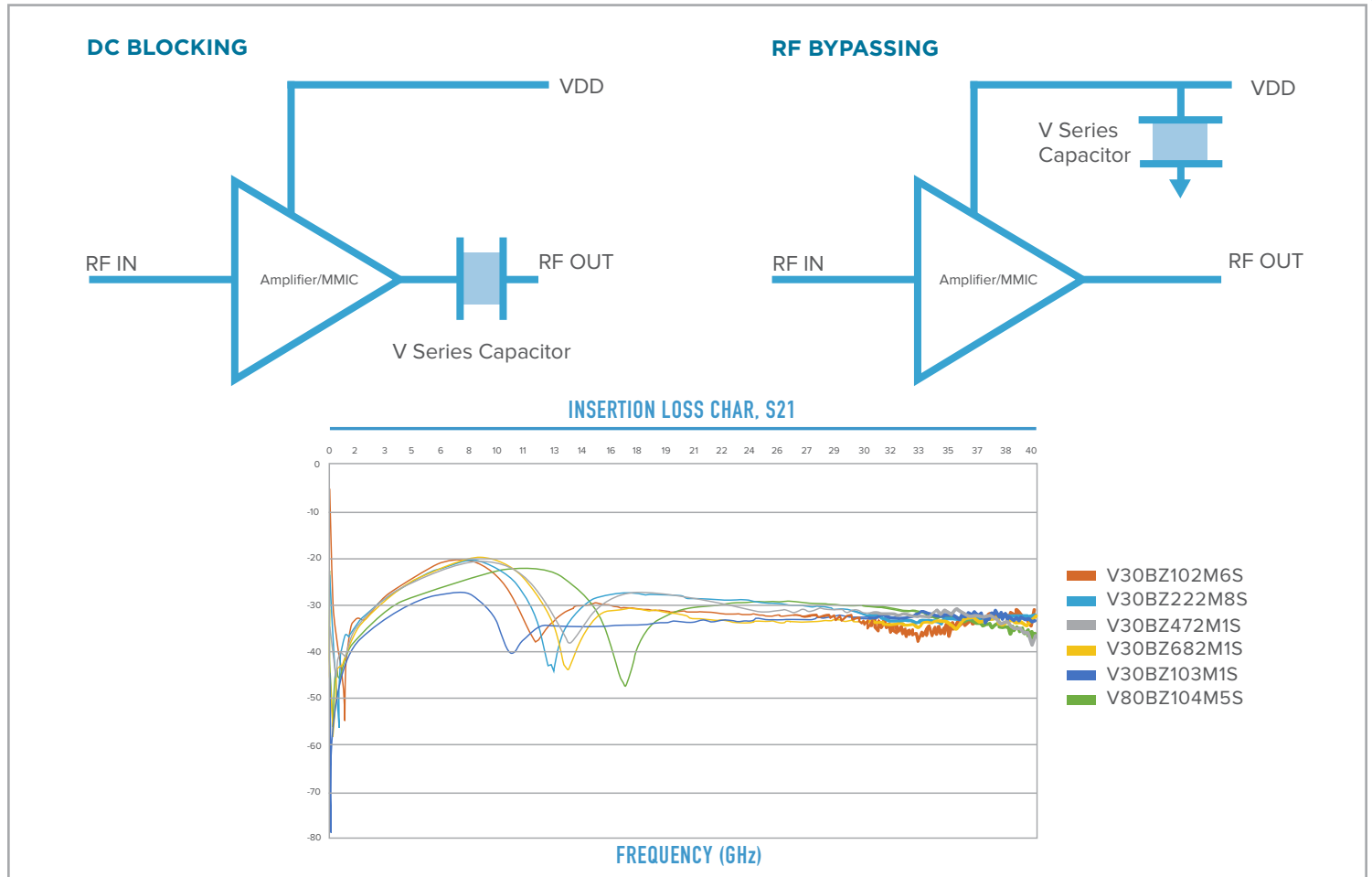

PERFORMANCE CHARACTERISTICS — V SERIES CAPACITORS

RECOMMENDED ATTACHMENT METHOD (CONDUCTIVE EPOXY) ALTERNATIVE ATTACHMENT METHOD (GOLD EUTECTIC)

Bonding can be done with either needle or automatic dispensers.

Epoxy curing defer to the epoxy manufacturer's preferred schedule but typically in the 125°C to 150°C range. Benefits of epoxy include easier repairs, cure doesn't need to be started immediately so multiple substrates may be processed at one time and epoxy is effective in higher frequencies.

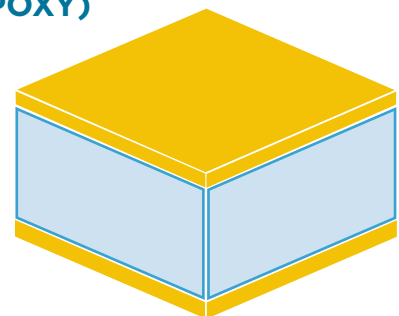

SLC — Border Cap®

DESCRIPTION

SLC with recessed metallization, available with borders on one or both sides.

Recessed metallization has been designed to minimize the potential of shorting during attachment (epoxy or solder).

- Available from 0.03pF to 2400pF
- Operating frequency up to 100GHz
- Wire Bondable
- 25, 50 and 100 Volt options
- Customized designs are available, please contact sales office

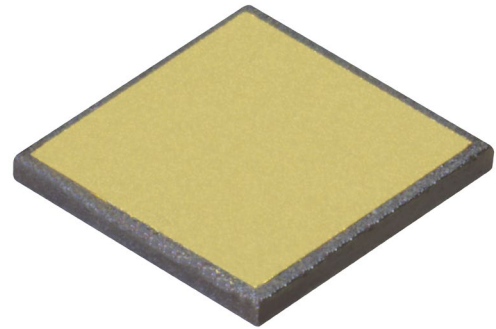

FUNCTIONAL APPLICATIONS

- DC Blocking
- RF Bypass
- Filtering
- Tuning and Coupling

TEST LEVEL CODES

| Commercial Level | |
|------------------|---|
| X | 100% 4-Side Visual 1% AQL Electrical (CAP/DF/IR & DWV) |

HIGH RELIABILITY

| | | | |
|---|---|---|--|
| A | MIL-PRF-49464 Group A | B | MIL-PRF-49464 Group B |
| | <ul style="list-style-type: none"> • 100% Thermal Shock • 100% Voltage Conditioning • 100% Electrical (CAP/DF/IR & DWV) • 100% 6-Side Visual • Bond Strength • Die Shear • Temperature Coefficient | | <ul style="list-style-type: none"> • MIL-PRF-49464 Group A • Immersion • Low Voltage Humidity • Life |
| | | D | • Customer Defined |
| | | E | • 6-Side Visual |

VOLTAGE

| Code | Voltage |
|------|-----------|
| 2 | 25 Volts |
| 5 | 50 Volts |
| 1 | 100 Volts |

CONFIGURATION

| Code | Description |
|------|--------------|
| B | Single-Sided |
| E | Double-Sided |

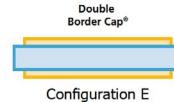
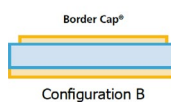

TOLERANCE

| Code | Description |
|------|-------------------------------|
| P | ± 0.01pF |
| A | ± 0.05pF |
| B | ± 0.1pF |
| C | ± 0.25pF |
| D | ± 0.50pF |
| K | ± 10% |
| L | ± 15% |
| M | ± 20% |
| X | GMV (Guarantee Minimum Value) |
| Z | +80%, -20% |

Border Caps need to have a tolerance that is effectively 10%.

ORDERING INFORMATION — SLC — BORDER CAP®

| D | 10 | BN | 100 | K | 1 | E | X | |
|-----------------|--|--------------------------------|--|---|--|--|--|--|
| Product | Case Size | Material | Capacitance (pF) | Tolerance | Voltage | Termination | Test Level | Packaging |
| D = Border Cap® | 10 12 15 20 25 30 35 40 50 | See material tables on Page 5. | R02 = 0.02 pF OR5 = 0.5 pF 1R0 = 1.0 pF 5R1 = 51 pF 100 = 10 pF 101 = 100 pF 152 = 1500 pF | A = ± 0.05pF B = ± 0.10pF C = ± 0.25pF D = ± 0.5pF F = ± 1% G = ± 2% J = ± 5% K = ± 10% L = ± 15% M = ± 20% Z = +80% -20% | 2 = 25V* 5 = 50V *For Capacitors with UX material only | B = Single Border E = Double Border | X A B D E See test level definitions on page 7. | B = Black Dotted E = Repopulated T = Tape and Reel Leave blank for generic waffle pack. See packaging definitions on Page 8. |
| | | | Refer to Capacitance range tables for available values. Consult an inside sales rep for custom solutions. | | | | | |

SLC — Border Cap®

DIMENSIONS

| STYLE | LENGTH/WIDTH | PAD SIZE | BORDER | THICKNESS |
|-------|-------------------------------------|------------------|------------------|--------------------------------------|
| D10 | 0.010" ± 0.001" (0.254mm ± 0.025mm) | 0.008" (0.203mm) | 0.001" (0.025mm) | 0.006" ± 0.0025" (0.152mm ± 0.064mm) |
| D12 | 0.012" ± 0.001" (0.305mm ± 0.025mm) | 0.010" (0.254mm) | 0.001" (0.025mm) | 0.006" ± 0.0025" (0.152mm ± 0.064mm) |
| D15 | 0.015" ± 0.001" (0.381mm ± 0.025mm) | 0.011" (0.279mm) | 0.002" (0.051mm) | 0.006" ± 0.0025" (0.152mm ± 0.064mm) |
| D20 | 0.020" ± 0.001" (0.508mm ± 0.025mm) | 0.016" (0.406mm) | 0.002" (0.051mm) | 0.006" ± 0.0025" (0.152mm ± 0.064mm) |
| D25 | 0.025" ± 0.001" (0.635mm ± 0.025mm) | 0.021" (0.533mm) | 0.002" (0.051mm) | 0.006" ± 0.0025" (0.152mm ± 0.064mm) |
| D30 | 0.030" ± 0.001" (0.762mm ± 0.025mm) | 0.026" (0.660mm) | 0.002" (0.051mm) | 0.006" ± 0.0025" (0.152mm ± 0.064mm) |
| D35 | 0.035" ± 0.001" (0.889mm ± 0.025mm) | 0.031" (0.787mm) | 0.002" (0.051mm) | 0.006" ± 0.0025" (0.152mm ± 0.064mm) |
| D40 | 0.040" ± 0.001" (1.016mm ± 0.025mm) | 0.036" (0.914mm) | 0.002" (0.051mm) | 0.006" ± 0.0025" (0.152mm ± 0.064mm) |
| D50 | 0.050" ± 0.001" (1.27mm ± 0.025mm) | 0.046" (1.168mm) | 0.002" (0.051mm) | 0.006" ± 0.0025" (0.152mm ± 0.064mm) |

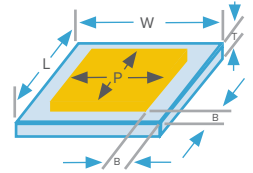

*UX material available in 25V (0.006" Thick) and 50V (0.010" Thick)

CAPACITANCE VALUES — SINGLE-SIDED

| STYLE | D10 | | D12 | | D15 | | D20 | | D25 | | D30 | | D35 | | D40 | | D50 | | | | | | | | | | |
|------------------|------|------|------|------|------|------|------|------|------|------|------|------|------|------|------|------|------|------|------|-----|-------|------|------|-------|------|------|-----|
| CAPACITANCE (pF) | | | | | | | | | | | | | | | | | | | | | | | | | | | |
| MATERIAL | MIN. | MAX. | TOL. | MIN. | MAX. | TOL. | MIN. | MAX. | TOL. | MIN. | MAX. | TOL. | MIN. | MAX. | TOL. | MIN. | MAX. | TOL. | | | | | | | | | |
| PI | 0.03 | 0.05 | P,K | 0.05 | 0.07 | P,K | 0.06 | 0.09 | P,K | 0.15 | 0.15 | A,K | 0.2 | 0.3 | A,K | 0.3 | 0.45 | A,K | 0.35 | 0.6 | A,B,K | 0.5 | 0.7 | A,B,K | 0.8 | 1.1 | B,K |
| PG | 0.04 | 0.06 | P,K | 0.06 | 0.09 | P,K | 0.08 | 0.1 | P,K | 0.15 | 0.2 | A,K | 0.25 | 0.4 | A,K | 0.35 | 0.55 | A,K | 0.5 | 0.8 | A,B,K | 0.65 | 0.95 | B,K | 1 | 1.5 | B,K |
| AH | 0.06 | 0.1 | P,K | 0.09 | 0.1 | P,K | 0.15 | 0.2 | A,K | 0.25 | 0.35 | A,K | 0.4 | 0.6 | A,K | 0.55 | 0.9 | B,K | 0.75 | 1.2 | B,K | 1 | 1.4 | B,K | 1.5 | 2.2 | K |
| CF | 0.07 | 0.1 | P,K | 0.1 | 0.15 | P,K | 0.15 | 0.2 | A,K | 0.25 | 0.45 | A,K | 0.45 | 0.7 | B,K | 0.65 | 1 | B,K | 0.8 | 1.3 | B,K | 1.1 | 1.6 | K | 1.7 | 2.4 | K |
| NA | 0.07 | 0.1 | P,K | 0.15 | 0.15 | A,K | 0.15 | 0.2 | A,K | 0.25 | 0.45 | A,K | 0.45 | 0.7 | B,K | 0.65 | 1 | B,K | 0.85 | 1.5 | B,K | 1.2 | 1.7 | K | 1.8 | 2.7 | K |
| CD | 0.15 | 0.15 | A,K | 0.2 | 0.25 | A,K | 0.25 | 0.35 | A,K | 0.45 | 0.7 | B,K | 0.7 | 1.1 | B,K | 0.95 | 1.6 | C,K | 1.4 | 2.2 | C,K | 1.8 | 2.7 | K | 2.7 | 4.3 | K |
| CG | 0.25 | 0.35 | A,K | 0.3 | 0.5 | A,K | 0.45 | 0.7 | B,K | 0.8 | 1.3 | C,K | 1.3 | 2 | C,K | 1.8 | 3 | D,K | 2.7 | 4.3 | D,K | 3.3 | 5.1 | K | 5.1 | 8.2 | K |
| DB | 0.25 | 0.35 | A,K | 0.35 | 0.5 | A,K | 0.45 | 0.7 | B,K | 0.8 | 1.3 | C,K | 1.3 | 2.2 | C,K | 1.9 | 3 | D,K | 2.7 | 4.3 | D,K | 3.6 | 5.1 | K | 5.6 | 8.2 | K |
| NP | 0.25 | 0.4 | A,K | 0.4 | 0.6 | B,K | 0.55 | 0.85 | B,K | 0.95 | 1.6 | C,K | 1.5 | 2.4 | C,K | 2.2 | 3.6 | D,K | 3 | 5.1 | D,K | 4.3 | 6.2 | K | 6.2 | 10 | K |
| NR | 0.5 | 0.8 | B,K | 0.7 | 1.1 | B,K | 1 | 1.6 | C,K | 1.8 | 3 | D,K | 3 | 4.7 | D,K | 4.3 | 6.8 | K | 6.2 | 10 | K | 7.5 | 11 | K | 12 | 18 | K |
| NS | 0.9 | 1.5 | C,K | 1.3 | 2.2 | C,K | 1.9 | 3 | D,K | 3.6 | 5.6 | D,K | 5.6 | 9.1 | K | 8.2 | 13 | K | 11 | 18 | K | 15 | 22 | K | 22 | 33 | K |
| NU | 1.8 | 3 | D,K | 2.7 | 4.3 | D,K | 3.9 | 5.6 | K | 6.8 | 11 | K | 11 | 18 | K | 16 | 27 | K | 22 | 36 | K | 30 | 43 | K | 47 | 68 | K |
| NV | 2.7 | 4.3 | D,K | 3.9 | 6.2 | K | 5.6 | 8.2 | D,K | 10 | 16 | K | 16 | 27 | K | 24 | 39 | K | 33 | 56 | K | 43 | 62 | K | 68 | 100 | K |
| BD | 2.2 | 3.3 | K | 3 | 5.1 | K | 4.3 | 6.8 | K | 8.2 | 13 | K | 13 | 20 | K | 18 | 30 | K | 27 | 43 | K | 33 | 51 | K | 51 | 82 | K |
| BC | 3.9 | 6.2 | K | 5.6 | 9.1 | K | 8.2 | 13 | K | 15 | 24 | K | 24 | 39 | K | 36 | 56 | K | 47 | 75 | K | 62 | 91 | K | 100 | 150 | K |
| BE | 3.6 | 6.2 | K | 5.6 | 9.1 | K | 8.2 | 12 | K | 15 | 22 | K | 24 | 36 | K | 33 | 56 | K | 47 | 75 | K | 62 | 91 | K | 91 | 130 | K |
| BL | 6.2 | 10 | K,M | 9.1 | 13 | K,M | 13 | 20 | K,M | 24 | 36 | K,M | 36 | 56 | K,M | 56 | 91 | K,M | 75 | 120 | K,M | 100 | 130 | K,M | 150 | 220 | K,M |
| BJ | 10 | 16 | K | 15 | 24 | K | 20 | 33 | K | 39 | 62 | K | 62 | 100 | K | 91 | 150 | K | 120 | 200 | K | 160 | 240 | K | 270 | 390 | K |
| BN | 13 | 22 | K,M | 20 | 33 | K,M | 30 | 43 | K,M | 51 | 82 | K,M | 82 | 130 | K,M | 120 | 200 | K,M | 160 | 270 | K,M | 220 | 330 | K,M | 330 | 510 | K,M |
| BU | 27 | 43 | M | 36 | 62 | M | 56 | 82 | M | 100 | 160 | M | 150 | 240 | M | 220 | 360 | M | 300 | 510 | M | 430 | 620 | M | 620 | 1000 | M |
| BV | 39 | 68 | M | 62 | 100 | M | 82 | 130 | M | 150 | 240 | M | 240 | 390 | M | 360 | 560 | M | 510 | 820 | M | 680 | 1000 | M | 1000 | 1500 | M |

UX MATERIAL CAPCITANCE TABLE (ALL VALUES M TOLERANCE ± 20%)

| VOLTAGE | MIN. | MAX. | MIN. | MAX. | MIN. | MAX. | MIN. | MAX. | MIN. | MAX. | MIN. | MAX. | MIN. | MAX. | MIN. | MAX. | MIN. | MAX. |
|---------|------|------|------|------|------|------|------|------|------|------|------|------|------|------|------|------|------|------|
| 25V | 82 | 100 | 120 | 140 | 160 | 200 | 300 | 370 | 490 | 590 | 710 | 860 | 1000 | 1200 | 1300 | 1600 | 2000 | 2400 |
| 50V | - | - | - | - | 100 | 140 | 200 | 240 | 300 | 370 | 450 | 540 | 600 | 750 | 800 | 950 | 1300 | 1500 |



SLC — Border Cap®

CAPACITANCE VALUES — DOUBLE-SIDED

| STYLE | D10 | | | D12 | | | D15 | | | D20 | | | D25 | | | D30 | | | D35 | | | D40 | | | D50 | | |
|------------------|------|------|------|------|------|------|------|------|------|------|------|------|------|------|------|------|------|-------|------|------|-------|------|------|-------|------|------|------|
| | MIN. | MAX. | TOL. | MIN. | MAX. | TOL. | MIN. | MAX. | TOL. | MIN. | MAX. | TOL. | MIN. | MAX. | TOL. | MIN. | MAX. | TOL. | MIN. | MAX. | TOL. | MIN. | MAX. | TOL. | MIN. | MAX. | TOL. |
| CAPACITANCE (pF) | | | | | | | | | | | | | | | | | | | | | | | | | | | |
| PI | 0.03 | 0.04 | P,K | 0.04 | 0.06 | P,K | 0.06 | 0.08 | P,K | 0.1 | 0.15 | A,K | 0.2 | 0.25 | A,K | 0.25 | 0.4 | A,K | 0.35 | 0.55 | A,B,K | 0.45 | 0.65 | A,B,K | 0.7 | 1.1 | B,K |
| PG | 0.04 | 0.06 | P,K | 0.06 | 0.08 | P,K | 0.07 | 0.1 | P,K | 0.15 | 0.2 | A,K | 0.25 | 0.35 | A,K | 0.35 | 0.5 | A,K | 0.45 | 0.7 | A,B,K | 0.6 | 0.9 | B,K | 0.95 | 1.4 | B,K |
| AH | 0.06 | 0.09 | P,K | 0.09 | 0.1 | P,K | 0.15 | 0.15 | A,K | 0.2 | 0.3 | A,K | 0.35 | 0.5 | A,K | 0.5 | 0.8 | A,B,K | 0.7 | 1.1 | B,K | 0.9 | 1.3 | B,K | 1.54 | 2.2 | K |
| CF | 0.07 | 0.1 | P,K | 0.1 | 0.15 | A,K | 0.15 | 0.15 | A,K | 0.25 | 0.35 | A,K | 0.4 | 0.65 | B,K | 0.6 | 0.95 | B,K | 0.8 | 1.3 | B,K | 1.1 | 1.6 | K | 1.7 | 2.4 | K |
| NA | 0.07 | 0.1 | P,K | 0.09 | 0.15 | A,K | 0.15 | 0.15 | A,K | 0.25 | 0.35 | A,K | 0.4 | 0.6 | B,K | 0.55 | 0.9 | B,K | 0.75 | 1.2 | B,K | 1 | 1.5 | K | 1.6 | 2.4 | K |
| CD | 0.15 | 0.15 | A,K | 0.15 | 0.25 | A,K | 0.2 | 0.3 | A,K | 0.4 | 0.6 | B,K | 0.6 | 1 | B,K | 0.9 | 1.5 | C,K | 1.3 | 2 | C,K | 1.7 | 2.4 | K | 2.7 | 3.9 | K |
| CG | 0.2 | 0.3 | A,K | 0.3 | 0.45 | A,K | 0.4 | 0.55 | A,K | 0.7 | 1.1 | B,K | 1.2 | 1.9 | C,K | 1.7 | 2.7 | C,K | 2.4 | 3.9 | D,K | 3.3 | 4.7 | K | 5.1 | 7.5 | K |
| DB | 0.25 | 0.35 | A,K | 0.35 | 0.5 | A,K | 0.5 | 0.7 | B,K | 0.9 | 1.3 | C,K | 1.4 | 2.1 | C,K | 2 | 3.1 | D,K | 2.8 | 4.3 | D,K | 3.6 | 5.6 | K | 5.6 | 9.1 | K |
| NP | 0.25 | 0.4 | A,K | 0.4 | 0.6 | B,K | 0.55 | 0.8 | B,K | 1 | 1.5 | C,K | 1.7 | 2.5 | C,K | 2.4 | 3.7 | D,K | 3.3 | 5.1 | D,K | 4.3 | 6.8 | K | 6.8 | 10 | K |
| NR | 0.45 | 0.7 | B,K | 0.65 | 1.1 | B,K | 0.85 | 1.3 | C,K | 1.6 | 2.4 | C,K | 2.7 | 4.3 | D,K | 3.9 | 6.2 | D,K | 5.6 | 9.1 | K | 7.5 | 11 | K | 12 | 16 | K |
| NS | 0.85 | 1.3 | C,K | 1.3 | 2 | C,K | 1.6 | 2.4 | D,K | 3 | 4.7 | D,K | 5.1 | 8.2 | K | 7.5 | 12 | K | 10 | 16 | K | 15 | 20 | K | 22 | 33 | K |
| NU | 1.7 | 2.7 | D,K | 2.7 | 3.9 | D,K | 3.3 | 4.7 | K | 6.2 | 9.1 | K | 10 | 16 | K | 15 | 24 | K | 20 | 33 | K | 27 | 39 | K | 43 | 62 | K |
| NV | 2.7 | 3.9 | D,K | 3.9 | 6.2 | K | 5.1 | 6.8 | K | 9.1 | 13 | K | 15 | 24 | K | 22 | 36 | K | 30 | 51 | K | 43 | 62 | K | 68 | 100 | K |
| BD | 2 | 3 | K | 3 | 4.7 | K | 3.9 | 5.6 | K | 7.5 | 11 | K | 12 | 18 | K | 18 | 27 | K | 24 | 39 | K | 33 | 47 | K | 51 | 75 | K |
| BC | 3.6 | 5.6 | K | 5.6 | 8.2 | K | 6.8 | 10 | K | 13 | 20 | K | 22 | 33 | K | 33 | 51 | K | 43 | 68 | K | 62 | 82 | K | 91 | 130 | K |
| BE | 3.6 | 6.2 | K | 5.1 | 8.2 | K | 6.8 | 10 | K | 13 | 20 | K | 22 | 33 | K | 30 | 51 | K | 43 | 68 | K | 56 | 82 | K | 91 | 130 | K |
| BL | 5.6 | 9.1 | K,M | 8.2 | 13 | K,M | 11 | 16 | K,M | 20 | 30 | K,M | 33 | 51 | K,M | 51 | 82 | K,M | 68 | 110 | K,M | 91 | 130 | K,M | 150 | 220 | K,M |
| BJ | 9.1 | 15 | K | 15 | 22 | K | 18 | 27 | K | 33 | 51 | K | 56 | 82 | K | 82 | 130 | K | 110 | 180 | K | 150 | 220 | K | 240 | 360 | K |
| BN | 13 | 20 | K,M | 20 | 30 | K,M | 24 | 36 | K,M | 47 | 68 | K,M | 75 | 120 | K,M | 110 | 180 | K,M | 150 | 240 | K,M | 200 | 300 | K,M | 330 | 470 | K,M |
| BU | 24 | 39 | M | 36 | 56 | M | 47 | 68 | M | 91 | 130 | M | 150 | 220 | M | 220 | 330 | M | 300 | 470 | M | 390 | 560 | M | 620 | 910 | M |
| BV | 39 | 62 | M | 56 | 91 | M | 75 | 110 | M | 150 | 220 | M | 220 | 360 | M | 330 | 510 | M | 470 | 750 | M | 620 | 910 | M | 1000 | 1500 | M |

UX MATERIAL CAPACITANCE TABLE (ALL VALUES M TOLERANCE ± 20%)

| VOLTAGE | MIN. | MAX. | MIN. | MAX. | MIN. | MAX. | MIN. | MAX. | MIN. | MAX. | MIN. | MAX. | MIN. | MAX. | MIN. | MAX. | MIN. | MAX. |
|---------|------|------|------|------|------|------|------|------|------|------|------|------|------|------|------|------|------|------|
| 25V | 75 | 91 | 110 | 130 | 140 | 170 | 270 | 320 | 440 | 540 | 650 | 800 | 900 | 1100 | 1200 | 1500 | 2000 | 2400 |
| 50V | - | - | - | - | 91 | 110 | 170 | 210 | 280 | 340 | 410 | 500 | 560 | 700 | 750 | 900 | 1200 | 1500 |



SLC — T-Cap®

DESCRIPTION

High Performance Single Layer Capacitors for RF, Microwave and Millimeter Wave Applications.

- Wire Bondable: 100μ" Au with a Ni Barrier Layer
- Customized solutions available, please contact sales office

FUNCTIONAL APPLICATIONS

- DC Blocking
- RF Bypassing
- Filtering
- Tuning
- Insulation
- Submounts
- Stand-Offs

BENEFITS

- Dimensional consistency
- Gold metallization for wire bonding
- Rugged construction



TEST LEVEL CODES

Commercial Level

| | |
|---|---|
| X | 100% 4-Side Visual 1% AQL Electrical (CAP/DF/IR & DWV) |
|---|---|

HIGH RELIABILITY

| | | | |
|---|---|---|--|
| A | MIL-PRF-49464 Group A | B | MIL-PRF-49464 Group B |
| | <ul style="list-style-type: none"> • 100% Thermal Shock • 100% Voltage Conditioning • 100% Electrical (CAP/DF/IR & DWV) • 100% 6-Side Visual • Bond Strength • Die Shear • Temperature Coefficient | | <ul style="list-style-type: none"> • MIL-PRF-49464 Group A • Immersion • Low Voltage Humidity • Life |
| | | D | • Customer Defined |
| | | E | • 6-Side Visual |

TEST LEVEL CODES

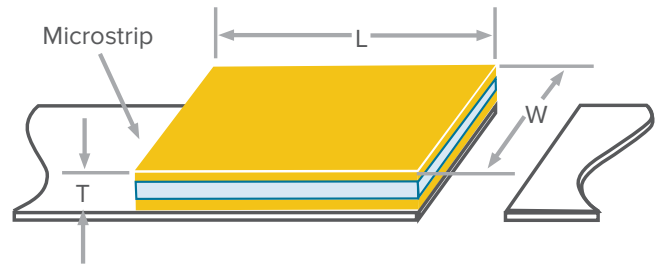

ORDERING INFORMATION — SLC — T-CAP®

| T | 30 | BV | 30 | X | 45 | P | X | |
|------------|---|--------------------------------|---|--|--|--|--|---|
| Product | Width | Material | Length | Tolerance | Thickness | Termination | Test Level | Packaging |
| T = T-Cap® | Two digit number representing the Width in .001" For Widths >.099", Consult an inside sales rep. | See material tables on Page 5. | Two digit number representing the Length in .001" For Lengths >.099", Consult an inside sales rep. | X = Length & Width: ±.001", Thickness: -.0005" S = Special | 35 – 99 Represents thickness in .0001" K0 = .010" M0 = .020" Examples: 55 = .0055" K2 = .012" M5 = .025" | P = Ni / Au T = Ni / AuSn M = Au | X See test level definitions on page 7. | T = Tape and Reel Leave blank for generic waffle pack. See packaging definitions on Page 8. |



SLC — Di-Cap[®]

DESCRIPTION

High Performance Single Layer Capacitors for RF, Microwave and Millimeter Wave Applications.

- Available from 0.03pF to 10,000pF
- Operating frequency up to 100GHz
- Wire Bondable:
- Customized solutions are available, please contact sales office

FUNCTIONAL APPLICATIONS

- DC Blocking
- RF Bypassing
- Filtering
- Tuning and Coupling

BENEFITS

- ESD Proof
- Gold metallization for wire bonding
- Rugged construction



TEST LEVEL CODES

Commercial Level

| | |
|---|---|
| X | 100% 4-Side Visual 1% AQL Electrical (CAP/DF/IR & DWV) |
|---|---|

VOLTAGE

| Code | Voltage |
|------|-----------|
| 2 | 25 Volts |
| 5 | 50 Volts |
| 1 | 100 Volts |

TOLERANCE

| Code | Description |
|------|-------------------------------|
| P | ± 0.01pF |
| A | ± 0.05pF |
| B | ± 0.1pF |
| C | ± 0.25pF |
| D | ± 0.50pF |
| K | ± 10% |
| L | ± 15% |
| M | ± 20% |
| X | GMV (Guarantee Minimum Value) |
| Z | +80%, -20% |

HIGH RELIABILITY

| | MIL-PRF-49464 Group A | MIL-PRF-49464 Group B |
|---|--|---|
| A | <ul style="list-style-type: none"> • 100% Thermal Shock • 100% Voltage Conditioning • 100% Electrical (CAP/DF/IR & DWV) | <ul style="list-style-type: none"> • 100% 6-Side Visual • Bond Strength • Die Shear • Temperature Coefficient |
| B | <ul style="list-style-type: none"> • MIL-PRF-49464 Group A • Immersion | <ul style="list-style-type: none"> • Low Voltage Humidity • Life |
| D | <ul style="list-style-type: none"> • Customer Defined | |
| E | <ul style="list-style-type: none"> • 6-Side Visual | |

ORDERING INFORMATION — SLC — Di-CAP[®]

| D | 10 | CF | OR1 | B | 5 | P | X | |
|-------------------------|--|--------------------------------|--|---|--------------------------------|---|--|---|
| Product | Case Size | Material | Capacitance (pF) | Tolerance | Voltage | Termination | Test Level | Packaging |
| D = Di-Cap [®] | 10 12 15 20 25 30 35 50 70 90 | See material tables on Page 5. | R02 = 0.02 pF OR5 = 0.5 pF 1R0 = 1.0 pF 5R1 = 5.1 pF 100 = 10 pF 101 = 100 pF 432 = 4,300 pF Refer to Capacitance range tables for available values. Consult an inside sales rep. for custom solutions. | A = ± 0.05pF B = ± 0.10pF C = ± 0.25pF D = ± 0.5pF F = ± 1% G = ± 2% J = ± 5% K = ± 10% L = ± 15% M = ± 20% Z = +80% -20% | 2 = 25V 5 = 50V 1 = 100V | P = Ni/Au or TiW/NiV/Au T = TiW/NiV/Au-Sn M = TiW/Au L = Single Beam Lead A = Axial Beam Lead S = Standing Axial Beam Lead D = Special Z = Tin Copper Ribbon | X A B D E See test level definitions on page 7. | T = Tape and Reel Leave blank for generic waffle pack. See packaging definitions on Page 8. |

Border Caps need to have a tolerance that is effectively 10%.

SLC — Di-Cap[®]

| STYLE | LENGTH | WIDTH | THICKNESS | |
|-------|-------------------------------|---|--|--|
| | | | 50 Volt | 100 Volt |
| D10 | 0.010" MAX. (0.254mm MAX.) | 0.010" + 0/-0.003" (0.254mm + 0/-0.076mm) | 0.004" ± 0.001" (0.102mm ± 0.025mm) | - |
| D12 | 0.015" MAX. (0.381mm MAX.) | 0.012" + 0.002"/-0.003" (0.305mm + 0.051mm/-0.076mm) | 0.004" ± 0.001" (0.102mm ± 0.025mm) | - |
| D15 | 0.020" MAX. (0.508mm MAX.) | 0.015" + 0/-0.003" (0.381mm + 0/-0.076mm) | 0.004" ± 0.001" (0.102mm ± 0.025mm) | 0.006" ± 0.001" (0.152mm ± 0.025mm) |
| D20 | 0.020" MAX. (0.508mm MAX.) | 0.020" + 0/-0.003" (0.508mm + 0/-0.076mm) | 0.004" ± 0.001" (0.102mm ± 0.025mm) | 0.006" ± 0.001" (0.152mm ± 0.025mm) |
| D25 | 0.030" MAX. (0.762mm MAX.) | 0.025" + 0/-0.003" (0.635mm + 0/-0.076mm) | 0.004" ± 0.001" (0.102mm ± 0.025mm) | 0.006" ± 0.001" (0.152mm ± 0.025mm) |
| D30 | 0.030" MAX. (0.762mm MAX.) | 0.030" + 0/-0.003" (0.762mm + 0/-0.076mm) | 0.004" ± 0.001" (0.102mm ± 0.025mm) | 0.006" ± 0.001" (0.152mm ± 0.025mm) |
| D35 | 0.040" MAX. (1.016mm MAX.) | 0.035" ± 0.005" (0.889mm ± 0.127mm) | 0.004" ± 0.001" (0.102mm ± 0.025mm) | 0.007" ± 0.002" (0.178mm ± 0.051mm) |
| D50 | 0.060" MAX. (1.524mm MAX.) | 0.050" ± 0.010" (1.270mm ± 0.254mm) | - | 0.007" ± 0.002" (0.178mm ± 0.051mm) |
| D70 | 0.080" MAX. (1.778mm MAX.) | 0.070" ± 0.010" (1.778mm ± 0.254mm) | - | 0.007" ± 0.002" (0.178mm ± 0.051mm) |
| D90 | 0.100" MAX. (2.54mm MAX.) | 0.090" ± 0.010" (2.286mm ± 0.254mm) | - | 0.007" ± 0.002" (0.178mm ± 0.051mm) |

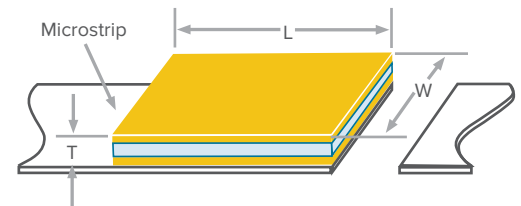

*UX material available in 25V (0.006" Thick) and 50V (0.010" Thick)

CAPACITANCE VALUES — 50 VOLT RATED Di-CAP[®]

| STYLE | D10 | | | D12 | | | D15 | | | D20 | | | D25 | | | D30 | | | D35 | | |
|------------------|------|------|------|------|------|------|------|------|-------|------|------|-------|------|------|-------|------|------|------|------|------|-------|
| CAPACITANCE (pF) | | | | | | | | | | | | | | | | | | | | | |
| MATERIAL | MIN. | MAX. | TOL. | MIN. | MAX. | TOL. | MIN. | MAX. | TOL. | MIN. | MAX. | TOL. | MIN. | MAX. | TOL. | MIN. | MAX. | TOL. | MIN. | MAX. | TOL. |
| PI | 0.03 | 0.05 | P | 0.04 | 0.1 | P | 0.06 | 0.15 | P,K | 0.09 | 0.2 | P,A | 0.2 | 0.4 | A,B | 0.25 | 0.45 | A,B | 0.35 | 0.85 | A,B |
| PG | 0.04 | 0.06 | P | 0.06 | 0.1 | P | 0.08 | 0.2 | P,A | 0.15 | 0.25 | P,A | 0.25 | 0.5 | A,B | 0.3 | 0.6 | A,B | 0.5 | 1.1 | A,B |
| AH | 0.06 | 0.1 | P | 0.08 | 0.2 | P,A | 0.15 | 0.3 | P,A | 0.2 | 0.4 | A,B | 0.35 | 0.8 | A,B | 0.45 | 0.95 | A,B | 0.7 | 1.8 | A,B,C |
| CF | 0.07 | 0.1 | P | 0.1 | 0.25 | P,A | 0.15 | 0.35 | P,A | 0.2 | 0.5 | P,A,B | 0.45 | 0.95 | A,B | 0.55 | 1.1 | A,B | 0.85 | 2 | A,B,C |
| NA | 0.06 | 0.1 | P | 0.09 | 0.2 | P,A | 0.15 | 0.3 | P,A | 0.2 | 0.45 | A,B | 0.4 | 0.9 | A,B | 0.5 | 1 | A,B | 0.8 | 1.9 | B,C |
| CD | 0.1 | 0.15 | P | 0.15 | 0.35 | P,A | 0.25 | 0.55 | A,B | 0.35 | 0.75 | A,B | 0.65 | 1.5 | A,B,C | 0.85 | 1.8 | B,C | 1.3 | 3.3 | B,C |
| CG | 0.2 | 0.35 | P,A | 0.3 | 0.75 | A,B | 0.45 | 1.1 | A,B | 0.65 | 1.4 | A,B,C | 1.2 | 2.7 | B,C | 1.6 | 3.3 | B,C | 2.7 | 6.2 | C,D |
| NP | 0.25 | 0.4 | A | 0.35 | 0.9 | A,B | 0.5 | 1.3 | A,B,C | 0.75 | 1.8 | B,C | 1.5 | 3.3 | C,D | 1.9 | 3.9 | C,D | 3 | 7.5 | C,D |
| NR | 0.45 | 0.8 | A,B | 0.65 | 1.7 | B,C | 1 | 2.4 | B,C | 1.5 | 3.3 | C,D | 2.7 | 6.2 | C,D,K | 3.6 | 7.5 | D | 5.6 | 13 | D,J,K |
| NS | 0.8 | 1.5 | B,C | 1.2 | 3 | B,C | 1.8 | 4.7 | C,D | 2.7 | 6.2 | C,D | 5.1 | 12 | K | 6.8 | 13 | K | 11 | 27 | K |
| NU | 1.6 | 3 | B,C | 2.4 | 6.2 | C,D | 3.6 | 9.1 | D,K | 5.6 | 12 | D,K | 11 | 24 | K | 15 | 27 | K | 22 | 51 | K |
| NV | 2.4 | 4.3 | C,D | 3.6 | 9.1 | D,K | 5.6 | 13 | D,K | 8.2 | 18 | K | 16 | 36 | K | 20 | 43 | K | 33 | 75 | K |
| BD | 1.8 | 3.6 | K | 3 | 7.5 | K | 4.3 | 11 | K | 6.2 | 13 | K | 12 | 27 | K | 16 | 33 | K | 27 | 62 | K |
| BC | 3.6 | 6.2 | K | 5.1 | 13 | K | 7.5 | 20 | K | 12 | 27 | K | 22 | 51 | K | 30 | 62 | K | 47 | 110 | K |
| BE | 3.3 | 6.2 | K | 5.1 | 13 | K | 7.5 | 18 | K | 12 | 24 | K | 22 | 51 | K | 30 | 62 | K | 47 | 110 | K |
| BL | 5.6 | 10 | K,M | 8.2 | 20 | K,M | 12 | 30 | K,M | 24 | 39 | K,M | 36 | 82 | K,M | 47 | 91 | K,M | 75 | 180 | K,M |
| BJ | 9.1 | 16 | K | 13 | 33 | K | 20 | 51 | K | 30 | 68 | K | 56 | 130 | K | 75 | 160 | K | 120 | 270 | K |
| BN | 12 | 22 | K,M | 18 | 47 | K,M | 27 | 68 | K,M | 43 | 91 | K,M | 82 | 180 | K,M | 100 | 220 | K,M | 160 | 390 | K,M |
| BU | 22 | 43 | M | 36 | 91 | M | 51 | 130 | M | 75 | 180 | M | 150 | 330 | M | 200 | 390 | M | 300 | 750 | M |
| BV | 36 | 68 | M | 56 | 130 | M | 82 | 200 | M | 120 | 270 | M | 240 | 510 | M | 300 | 620 | M | 510 | 1200 | M |



SLC — Di-Cap®

CAPACITANCE VALUES — 100 VOLT RATED Di-CAP®

| STYLE | D15 | | | D20 | | | D25 | | | D30 | | | D35 | | | D50 | | | D70 | | | D90 | | |
|------------------|------|------|------|------|------|-------|------|------|-------|------|------|-------|------|------|-------|------|------|-------|------|------|------|------|------|-------|
| CAPACITANCE (pF) | | | | | | | | | | | | | | | | | | | | | | | | |
| MATERIAL | MIN. | MAX. | TOL. | MIN. | MAX. | TOL. | MIN. | MAX. | TOL. | MIN. | MAX. | TOL. | MIN. | MAX. | TOL. | MIN. | MAX. | TOL. | MIN. | MAX. | TOL. | MIN. | MAX. | TOL. |
| PI | 0.04 | 0.1 | P | 0.06 | 0.1 | P | 0.15 | 0.25 | P,A | 0.15 | 0.3 | P,A | 0.2 | 0.55 | A,B | 0.5 | 1.3 | A,B | 0.95 | 2 | B,C | 1.2 | 3 | B,C |
| PG | 0.06 | 0.1 | P | 0.08 | 0.15 | P | 0.2 | 0.35 | A | 0.2 | 0.4 | A,B | 0.25 | 0.75 | A,B | 0.6 | 1.7 | B,C | 1.2 | 2.7 | B,C | 1.5 | 3.9 | B,C |
| AH | 0.08 | 0.2 | P,A | 0.15 | 0.25 | P,A | 0.25 | 0.5 | A,B | 0.35 | 0.65 | A,B | 0.4 | 1.2 | A,B,C | 0.95 | 2.7 | B,C | 1.9 | 3.9 | B,C | 2.4 | 6.2 | C,D |
| CF | 0.1 | 0.25 | P,A | 0.15 | 0.3 | P,A | 0.3 | 0.65 | A,B | 0.4 | 0.75 | A,B | 0.45 | 1.4 | A,B,C | 1.1 | 3 | B,C | 2.4 | 4.7 | C,D | 3 | 7.5 | C,D |
| NA | 0.09 | 0.2 | P,A | 0.15 | 0.3 | P,A | 0.3 | 0.5 | A,B | 0.35 | 0.7 | A,B | 0.45 | 1.3 | A,B,C | 1.1 | 3 | B,C | 2.2 | 4.3 | C,D | 2.7 | 6.8 | C,D |
| CD | 0.15 | 0.35 | P,A | 0.25 | 0.5 | A,B | 0.5 | 1 | A,B | 0.6 | 1.2 | A,B,C | 0.7 | 2.2 | B,C | 1.7 | 4.7 | C,D | 3.6 | 7.5 | C,D | 4.3 | 12 | D,J,K |
| CG | 0.3 | 0.7 | A,B | 0.45 | 0.95 | A,B | 0.95 | 1.9 | A,B,C | 1.1 | 2.2 | B,C | 1.3 | 3.9 | B,C,D | 3.3 | 9.1 | C,D,K | 6.8 | 13 | D,K | 8.2 | 22 | J,K |
| DB | 0.3 | 0.75 | A,B | 0.45 | 1 | A,B | 1 | 1.9 | B,C | 1.1 | 2.2 | B,C | 1.4 | 4.3 | C,D | 3.3 | 9.1 | C,D,K | 6.8 | 15 | D,K | 8.2 | 22 | J,K |
| NP | 0.35 | 0.85 | A,B | 0.55 | 1.2 | B,C | 1.2 | 2.2 | B,C | 1.3 | 2.7 | B,C,D | 1.6 | 5.1 | C,D | 3.9 | 11 | C,D,K | 8 | 16 | J,K | 10 | 27 | J,K |
| NR | 0.65 | 1.6 | B,C | 1 | 2.2 | B,C | 2.2 | 4.3 | C,D | 2.7 | 5.1 | C,D | 3 | 9.1 | D,K | 7.5 | 20 | J,K | 15 | 33 | J,K | 20 | 51 | J,K |
| NS | 1.2 | 3 | C,D | 1.9 | 3.9 | C,D | 3.9 | 8.2 | D,K | 4.7 | 9.1 | D,K | 5.6 | 18 | K | 15 | 39 | K | 30 | 62 | K | 36 | 91 | K |
| NU | 2.4 | 6.2 | C,D | 3.9 | 8.2 | C,D,k | 8.2 | 16 | D,J,K | 9.1 | 18 | J,K | 12 | 36 | J,K | 30 | 82 | J,K | 56 | 120 | K | 68 | 180 | K |
| NV | 3.6 | 9.1 | D,K | 5.6 | 12 | D,K | 12 | 24 | K | 15 | 27 | K | 18 | 51 | K | 43 | 120 | K | 91 | 180 | K | 100 | 270 | K |
| BD | 3 | 6.8 | K | 4.3 | 9 | K | 8 | 18 | K | 11 | 22 | K | 13 | 39 | K | 33 | 91 | K | 68 | 130 | K | 82 | 220 | K |
| BC | 5.6 | 13 | K | 8 | 18 | K | 16 | 33 | K | 20 | 43 | K | 24 | 160 | K | 62 | 160 | K | 120 | 270 | K | 150 | 390 | K |
| BE | 5.1 | 13 | K | 8 | 16 | K | 15 | 33 | K | 20 | 39 | K | 24 | 160 | K | 62 | 160 | K | 120 | 240 | K | 150 | 390 | K |
| BL | 8.2 | 20 | K,M | 13 | 27 | K,M | 24 | 51 | K,M | 33 | 62 | K,M | 39 | 270 | K,M | 100 | 270 | K,M | 200 | 390 | K,M | 240 | 620 | K,M |
| BJ | 13 | 33 | K | 20 | 47 | K | 38 | 82 | K | 51 | 100 | K | 62 | 430 | K | 160 | 430 | K | 330 | 680 | K | 390 | 1000 | K |
| BN | 18 | 47 | K,M | 30 | 62 | K,M | 56 | 120 | K,M | 68 | 130 | K,M | 91 | 560 | K,M | 220 | 560 | K,M | 430 | 910 | K,M | 510 | 1300 | K,M |
| BU | 36 | 82 | M | 56 | 120 | M | 100 | 220 | M | 130 | 270 | M | 160 | 1100 | M | 390 | 1100 | M | 820 | 1600 | M | 1000 | 2700 | M |
| BV | 56 | 130 | M | 82 | 180 | M | 160 | 360 | M | 220 | 430 | M | 270 | 1800 | M | 620 | 1800 | M | 1300 | 2700 | M | 1600 | 4300 | M |

UX MATERIAL CAPCITANCE TABLE

| STYLE | D10 | | D12 | | D15 | | D20 | | D25 | | D30 | | D35 | | D50 | | D70 | | D90 | |
|------------------|------|------|------|------|------|------|------|------|------|------|------|------|------|------|------|------|------|------|------|--------|
| CAPACITANCE (pF) | | | | | | | | | | | | | | | | | | | | |
| MATERIAL | MIN. | MAX. | MIN. | MAX. | MIN. | MAX. | MIN. | MAX. | MIN. | MAX. | MIN. | MAX. | MIN. | MAX. | MIN. | MAX. | MIN. | MAX. | MIN. | MAX. |
| 25V | 51 | 75 | 75 | 180 | 110 | 250 | 170 | 340 | 280 | 650 | 390 | 800 | 620 | 1400 | 1600 | 3200 | 3500 | 5900 | 6200 | 10,000 |
| 50V | - | - | - | - | - | - | 100 | 200 | 170 | 390 | 240 | 470 | 360 | 850 | 940 | 2000 | 2100 | 3500 | 3700 | 5500 |



SLC — Bar Cap®

DESCRIPTION

Multiple Decoupling/Blocking Capacitors in a Single Array.

- Operating frequency up to 30GHz
- Wire Bondable: 100μ" Au with a Ni Barrier Layer
- Customized solutions available, please contact sales office

FUNCTIONAL APPLICATIONS

- DC Blocking
- RF Bypassing
- Decoupling
- GaAs ICs

BENEFITS

- Single insertion reduces complexity and cost
- Gold metallization for wire bonding
- Reduce bond wires for improved performance

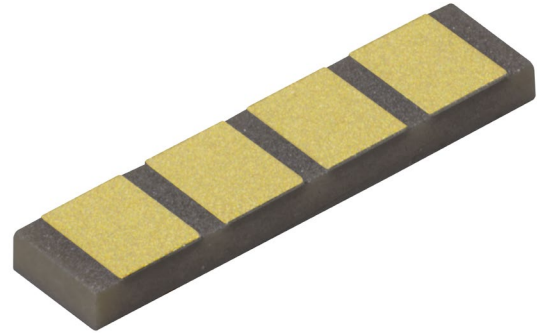

TEST LEVEL CODES

Commercial Level

| | |
|---|---|
| X | 100% 4-Side Visual 1% AQL Electrical (CAP/DF/IR & DWV) |
|---|---|

HIGH RELIABILITY

| | | | |
|---|---|---|--|
| A | MIL-PRF-49464 Group A | B | MIL-PRF-49464 Group B |
| | <ul style="list-style-type: none"> • 100% Thermal Shock • 100% Voltage Conditioning • 100% Electrical (CAP/DF/IR & DWV) • 100% 6-Side Visual • Bond Strength • Die Shear • Temperature Coefficient | | <ul style="list-style-type: none"> • MIL-PRF-49464 Group A • Immersion • Low Voltage Humidity • Life |
| | | D | • Customer Defined |
| | | E | • 6-Side Visual |

TOLERANCE

| Code | Description |
|------|-------------|
| Z | +80%, -20% |

VOLTAGE

| Code | Voltage |
|------|-----------|
| 2 | 25 Volts |
| 5 | 50 Volts |
| 1 | 100 Volts |

ORDERING INFORMATION — SLC — BAR CAP®

| E | 40 | BU | 151 | Z | 1 | P | X | 4 | |
|--------------|----------------------|--------------------------------|--|---------------|--------------------|-----------------------|--|---------------------------|---|
| Product | Case Size | Material | Capacitance (pF) | Tolerance | Voltage | Termination | Test Level | Capacitor Quantity (mils) | Packaging |
| E = Bar Cap® | 20 25 30 40 | See material tables on Page 5. | 800 = 80 pF 101 = 101 pF 121 = 120 pF 151 = 150 pF Consult an inside sales rep for custom solutions. | Z = +80% -20% | 2 = 25V 5 = 50V | P = Ni / Au M = Au | X See test level definitions on page 7. | 3 4 6 Etc. | T = Tape and Reel Leave blank for generic waffle pack. See packaging definitions on Page 8. |

*Custom Solutions are available; however, additional tooling costs may apply. Please contact the sales office for more information.

SLC — Bar Cap®

DIMENSIONS

| Case Style | No. of Caps | Width | Length | Thickness | Pad Size |
|------------|-------------|--------------------------------------|-----------------------------------|-----------|--|
| E20 | 3 | 0.020" ±0.003" (0.508mm ±0.076mm) | 0.065" ±0.005" (1.651mm ±0.127mm) | See below | 0.020" ±0.015" (0.508mm ±0.381mm) |
| | 4 | | 0.085" ±0.005" (2.159mm ±0.127mm) | | |
| | 6 | | 0.125" ±0.005" (3.175mm ±0.127mm) | | |
| E25 | 3 | 0.025" ±0.003" (0.635mm ±0.076mm) | 0.065" ±0.005" (1.651mm ±0.127mm) | See below | 0.025" ±0.015" (0.635mm ±0.381mm) |
| | 4 | | 0.085" ±0.005" (2.159mm ±0.127mm) | | |
| | 6 | | 0.125" ±0.005" (3.175mm ±0.127mm) | | |
| E30 | 3 | 0.030" ±0.003" (0.762mm ±0.076mm) | 0.065" ±0.005" (1.651mm ±0.127mm) | See below | 0.030" ±0.015" (0.762mm ±0.381mm) |
| | 4 | | 0.085" ±0.005" (2.159mm ±0.127mm) | | |
| | 6 | | 0.125" ±0.005" (3.175mm ±0.127mm) | | |
| E40 | 3 | 0.040" ±0.003" (1.016mm ±0.076mm) | 0.065" ±0.005" (1.651mm ±0.127mm) | See below | 0.040" ±0.015" 4 (1.016mm ±0.381mm) |
| | 4 | | 0.085" ±0.005" (2.159mm ±0.127mm) | | |
| | 6 | | 0.125" ±0.005" (3.175mm ±0.127mm) | | |

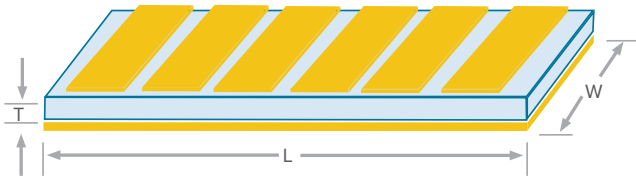

| Voltage | Thickness |
|---------|-------------------------------------|
| 100 V | 0.007" ± 0.001" (0.178mm ± 0.025mm) |
| 25 V | 0.006" ± 0.001" (0.152mm ± 0.025mm) |
| 50 V | 0.010" ± 0.001" (0.254mm ± 0.025mm) |

CAPACITANCE VALUES — BAR GAP®

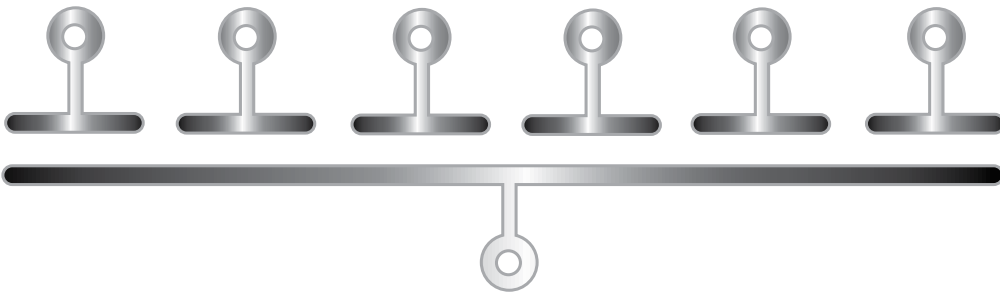

SLC — Gap Cap®

DESCRIPTION

Series Configured Capacitor for Microwave Applications. Recessed metallization has been designed to minimize the potential of shorting during attachment (epoxy or solder).

- Available from 0.2pF to 800pF
- Operating frequency up to 30GHz
- Customized solutions

FUNCTIONAL APPLICATIONS

- DC Blocking
- RF Bypassing
- Filtering
- Tuning
- Coupling

BENEFITS

- Eliminates wire bonding
- Coplanar waveguide
- Low insertion loss

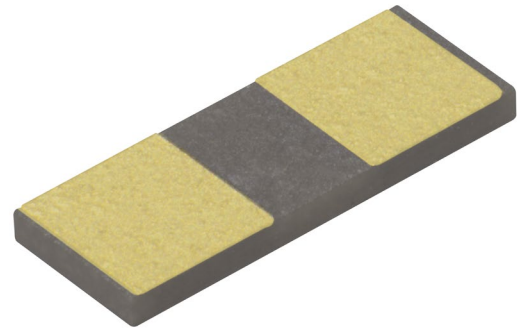

TEST LEVEL CODES

Commercial Level

| | |
|---|---|
| X | 100% 4-Side Visual 1% AQL Electrical (CAP/DF/IR & DWV) |
|---|---|

HIGH RELIABILITY

| | | | |
|---|---|---|--|
| A | MIL-PRF-49464 Group A | B | MIL-PRF-49464 Group B |
| | <ul style="list-style-type: none"> • 100% Thermal Shock • 100% Voltage Conditioning • 100% Electrical (CAP/DF/IR & DWV) • 100% 6-Side Visual • Bond Strength • Die Shear • Temperature Coefficient | | <ul style="list-style-type: none"> • MIL-PRF-49464 Group A • Immersion • Low Voltage Humidity • Life |
| | | D | • Customer Defined |
| | | E | • 6-Side Visual |

TOLERANCE

| Code | Description |
|------|-------------------------------|
| A | ± 0.05pF |
| B | ± 0.1pF |
| C | ± 0.25pF |
| D | ± 0.50pF |
| K | ± 10% |
| L | ± 15% |
| M | ± 20% |
| X | GMV (Guarantee Minimum Value) |
| Z | +80%, -20% |

VOLTAGE

| Code | Voltage |
|------|----------|
| 2 | 25 Volts |
| 5 | 50 Volts |

ORDERING INFORMATION — SLC — GAP CAP®

| Product | Case Size | Material | Capacitance (pF) | Tolerance | Voltage | Termination | Test Level | Gap Width (mils) | Packaging |
|--------------|--|--------------------------------|---|---|--------------------|-----------------------|---|----------------------|---|
| G = Gap-Cap® | 10 15 20 25 30 35 50 | See material tables on Page 5. | R01 = 0.01 pF OR5 = 0.5 pF 1R0 = 1.0 pF 5R1 = 5.1 pF 100 = 10 pF 511 = 510 pF Refer to Capacitance range tables for available values. Consult an inside sales rep for custom solutions. | A = ±0.05pF B = ±0.10pF C = ±0.25pF D = ±0.5pF F = ±1% G = ±2% J = ±5% K = ±10% L = ±15% M = ±20% Z = +80% -20% | 2 = 25V 5 = 50V | P = Ni / Au M = Au | Y X A B D E See test level definitions on page 7. | 05 08 10 15 | T = Tape and Reel Leave blank for generic waffle pack. See packaging definitions on Page 8. |

SLC — Gap Cap[®]

DIMENSIONS — 25 VOLT GAP CAP[®]

| Style | Gap (Nominal) | Width | Length | Thickness |
|-------|------------------|--|-------------------------------|--|
| G10 | 0.005" (0.127mm) | 0.010" + 0/-0.003" (0.254mm + 0/-0.076mm) | 0.030" MAX. (0.762mm MAX.) | 0.004" ± 0.001" (0.102mm ± 0.025mm) |
| G15 | 0.008" (0.203mm) | 0.015" + 0/-0.003" (0.381mm + 0/-0.076mm) | 0.040" MAX. (1.016mm MAX.) | |
| G20 | 0.010" (0.254mm) | 0.020" + 0/-0.003" (0.508mm + 0/-0.076mm) | 0.050" MAX. (1.270mm MAX.) | |
| G25 | 0.020" (0.508mm) | 0.025" + 0/-0.003" (0.635mm + 0/-0.076mm) | 0.060" MAX. (1.524mm MAX.) | |
| G30 | | 0.030" + 0/-0.003" (0.762mm + 0/-0.076mm) | | |
| G35 | | 0.035" ± 0.005" (0.889mm ± 0.127mm) | | |
| G50 | | 0.050" ± 0.010" (1.27mm ± 0.254mm) | 0.080" MAX. (2.032mm MAX.) | 0.006" ± 0.001" (0.102mm ± 0.064mm) |

*UX thickness 0.006" (0.152mm)

DIMENSIONS — 50 VOLT GAP CAP[®]

| Style | Gap (Nominal) | Width | Length | Thickness |
|-------|------------------|--|-------------------------------|--|
| G10 | 0.005" (0.127mm) | 0.010" + 0/-0.003" (0.254mm + 0/-0.076mm) | 0.030" MAX. (0.762mm MAX.) | 0.006" ± 0.001" (0.102mm ± 0.064mm) |
| G15 | 0.008" (0.203mm) | 0.015" + 0/-0.003" (0.381mm + 0/-0.076mm) | 0.040" MAX. (1.016mm MAX.) | |
| G20 | 0.010" (0.254mm) | 0.020" + 0/-0.003" (0.508mm + 0/-0.076mm) | 0.050" MAX. (1.270mm MAX.) | |
| G25 | 0.020" (0.508mm) | 0.025" + 0/-0.003" (0.635mm + 0/-0.076mm) | 0.080" MAX. (2.032mm MAX.) | |
| G30 | | 0.030" + 0/-0.003" (0.762mm + 0/-0.076mm) | | |
| G35 | | 0.035" ± 0.005" (0.889mm ± 0.127mm) | | |
| G50 | | 0.050" ± 0.010" (1.27mm ± 0.254mm) | | 0.006" ± 0.001" (0.102mm ± 0.064mm) |

*UX thickness 0.010" (0.254mm)

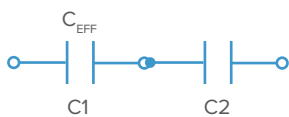

$C_{EFF} = \text{SERIES EQUIVALENT}$
 $C1 = C2 \quad C_{EFF} = C1 \div 2$

ALL GAP CAP VALUES ARE LISTED AS C_{EFF}

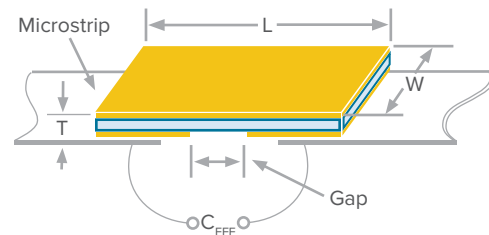
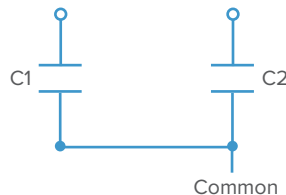

SLC — Gap Cap®

CAPACITANCE VALUES — 25 VOLT RATED GAP CAP®

| STYLE | G10 | | | G15 | | | G20 | | | G25 | | | G30 | | | G35 | | | G50 | | |
|------------------|------|------|------|------|------|------|------|------|------|------|------|------|------|------|------|------|------|------|------|------|------|
| CAPACITANCE (pF) | | | | | | | | | | | | | | | | | | | | | |
| MATERIAL | MIN. | MAX. | TOL. | MIN. | MAX. | TOL. | MIN. | MAX. | TOL. | MIN. | MAX. | TOL. | MIN. | MAX. | TOL. | MIN. | MAX. | TOL. | MIN. | MAX. | TOL. |
| PI | 0.02 | 0.03 | A | 0.03 | 0.07 | A | 0.04 | 0.10 | A | 0.05 | 0.15 | A | 0.06 | 0.15 | A | 0.07 | 0.20 | A | - | - | - |
| PG | 0.02 | 0.05 | A | 0.04 | 0.10 | A | 0.05 | 0.15 | A | 0.07 | 0.20 | A | 0.08 | 0.25 | A | 0.09 | 0.25 | A | - | - | - |
| AH | 0.04 | 0.08 | A | 0.06 | 0.15 | A | 0.08 | 0.25 | A | 0.10 | 0.30 | A | 0.15 | 0.35 | A | 0.15 | 0.45 | A | - | - | - |
| CF | 0.04 | 0.09 | A | 0.08 | 0.15 | A | 0.10 | 0.30 | A | 0.15 | 0.35 | A | 0.15 | 0.45 | A | 0.20 | 0.50 | A | - | - | - |
| NA | 0.04 | 0.08 | A | 0.07 | 0.15 | A | 0.09 | 0.25 | A | 0.15 | 0.35 | A | 0.15 | 0.40 | A | 0.15 | 0.50 | A | - | - | - |
| CD | 0.06 | 0.10 | A | 0.15 | 0.25 | A | 0.15 | 0.45 | A | 0.20 | 0.60 | B | 0.25 | 0.70 | B | 0.30 | 0.80 | B | - | - | - |
| CG | 0.15 | 0.25 | A | 0.25 | 0.50 | A | 0.30 | 0.90 | B | 0.35 | 1.1 | B | 0.45 | 1.3 | C | 0.50 | 1.6 | C | - | - | - |
| DB | 0.15 | 0.25 | A | 0.25 | 0.55 | B | 0.30 | 0.90 | B | 0.35 | 1.1 | B | 0.45 | 1.4 | C | 0.50 | 1.6 | C | - | - | - |
| NP | 0.15 | 0.30 | A | 0.30 | 0.65 | B | 0.35 | 1.1 | C | 0.40 | 1.3 | C | 0.55 | 1.6 | C | 0.60 | 1.9 | C | - | - | - |
| NR | 0.25 | 0.60 | A,B | 0.50 | 1.2 | B | 0.65 | 2.0 | C | 0.75 | 2.4 | C | 0.95 | 3.0 | D | 1.1 | 3.6 | D | - | - | - |
| NS | 0.50 | 1.2 | B | 0.90 | 2.2 | C,K | 1.2 | 3.9 | D,K | 1.4 | 4.7 | D,K | 1.8 | 5.6 | D,K | 2.2 | 6.8 | K | - | - | - |
| NU | 0.95 | 2.4 | C,K | 1.8 | 4.3 | C,K | 2.4 | 7.5 | D,K | 3.0 | 9.1 | D,K | 3.6 | 11 | K | 4.3 | 13 | K | - | - | - |
| NV | 1.4 | 3.6 | C,K | 2.7 | 6.8 | D,K | 3.6 | 11 | D,K | 4.3 | 13 | K | 5.6 | 16 | K | 6.2 | 20 | K | - | - | - |
| BD | 1.1 | 2.7 | K | 2.2 | 5.1 | K | 2.7 | 9.1 | K | 3.3 | 11 | K | 4.3 | 13 | K | 5.1 | 16 | K | - | - | - |
| BC | 2.0 | 5.1 | K | 3.9 | 10 | K | 5.1 | 16 | K | 6.2 | 20 | K | 8.2 | 24 | K | 9.1 | 27 | K | - | - | - |
| BE | 2.0 | 4.7 | K | 3.9 | 9.1 | K | 5.1 | 16 | K | 6.2 | 20 | K | 7.5 | 24 | K | 9.1 | 27 | K | - | - | - |
| BL | 3.3 | 7.5 | K | 6.2 | 15 | K | 8.2 | 24 | K | 10 | 30 | K | 12 | 39 | K | 15 | 43 | K | - | - | - |
| BJ | 5.1 | 13 | K | 10 | 24 | K | 13 | 43 | K | 16 | 51 | K | 20 | 62 | K | 24 | 75 | K | - | - | - |
| BN | 7.5 | 18 | K | 15 | 33 | K | 18 | 56 | K | 22 | 68 | K | 27 | 82 | K | 33 | 100 | K | - | - | - |
| BU | 15 | 33 | K,M | 27 | 62 | K,M | 33 | 110 | K,M | 43 | 130 | K,M | 51 | 160 | K,M | 62 | 180 | K,M | - | - | - |
| BV | 22 | 51 | M | 43 | 100 | M | 51 | 160 | M | 68 | 200 | M | 82 | 240 | M | 100 | 300 | M | - | - | - |
| UX | 40 | 60 | M | 90 | 120 | M | 150 | 200 | M | 190 | 250 | M | 265 | 300 | M | 310 | 350 | M | 500 | 800 | M |

CAPACITANCE VALUES — 50 VOLT RATED GAP CAP®

| STYLE | G10 | | | G15 | | | G20 | | | G25 | | | G30 | | | G35 | | | G50 | | |
|------------------|------|------|------|------|------|------|------|------|------|------|------|------|------|------|------|------|------|------|------|-------|------|
| CAPACITANCE (pF) | | | | | | | | | | | | | | | | | | | | | |
| MATERIAL | MIN. | MAX. | TOL. | MIN. | MAX. | TOL. | MIN. | MAX. | TOL. | MIN. | MAX. | TOL. | MIN. | MAX. | TOL. | MIN. | MAX. | TOL. | MIN. | MAX. | TOL. |
| PI | 0.02 | 0.02 | A | 0.03 | 0.05 | A | 0.03 | 0.08 | A | 0.04 | 0.15 | A | 0.05 | 0.15 | A | 0.06 | 0.20 | A | 0.07 | 0.35 | A |
| PG | 0.02 | 0.03 | A | 0.03 | 0.06 | A | 0.04 | 0.10 | A | 0.05 | 0.20 | A | 0.07 | 0.25 | A | 0.07 | 0.25 | A | 0.09 | 0.50 | A |
| AH | 0.03 | 0.05 | A | 0.05 | 0.10 | A | 0.06 | 0.15 | A | 0.08 | 0.30 | A | 0.10 | 0.35 | A | 0.15 | 0.45 | A | 0.15 | 0.75 | A,B |
| CF | 0.03 | 0.06 | A | 0.06 | 0.10 | A | 0.07 | 0.20 | A | 0.09 | 0.35 | A | 0.15 | 0.45 | A | 0.15 | 0.50 | A | 0.20 | 0.90 | A,B |
| NA | 0.03 | 0.05 | A | 0.05 | 0.10 | A | 0.07 | 0.15 | A | 0.08 | 0.35 | A | 0.15 | 0.40 | A | 0.15 | 0.45 | A | 0.20 | 0.85 | A,B |
| CD | 0.04 | 0.09 | A | 0.08 | 0.15 | A | 0.15 | 0.30 | A | 0.15 | 0.55 | A | 0.20 | 0.70 | A,B | 0.20 | 0.80 | A,B | 0.30 | 1.4 | A,B |
| CG | 0.08 | 0.15 | A | 0.15 | 0.35 | A | 0.20 | 0.60 | A | 0.30 | 1.1 | A | 0.35 | 1.3 | A,B | 0.40 | 1.5 | A,B | 0.50 | 2.7 | A,B |
| DB | 0.08 | 0.15 | A | 0.20 | 0.35 | A | 0.25 | 0.60 | A | 0.30 | 1.1 | A,B | 0.35 | 1.3 | B,C | 0.40 | 1.6 | B,C | 0.50 | 2.7 | B,C |
| NP | 0.09 | 0.20 | A | 0.20 | 0.40 | A | 0.25 | 0.70 | B | 0.35 | 1.3 | B | 0.40 | 1.6 | B,C | 0.50 | 1.9 | B,C | 0.60 | 3.3 | B,C |
| NR | 0.20 | 0.40 | A | 0.35 | 0.80 | B | 0.45 | 1.3 | B,C | 0.60 | 2.4 | B,C | 0.75 | 3.0 | D | 0.90 | 3.6 | D | 1.2 | 6.2 | D,K |
| NS | 0.35 | 0.8 | C,K | 0.65 | 1.5 | C,K | 0.85 | 2.4 | C,K | 1.1 | 4.7 | C | 1.4 | 5.6 | D,K | 1.6 | 6.2 | D,K | 2.2 | 11 | D,K |
| NU | 0.65 | 1.6 | C,K | 1.3 | 3.0 | C,K | 1.7 | 5.1 | D,K | 2.2 | 9.1 | D,K | 3.0 | 11 | K | 3.3 | 13 | K | 4.3 | 22 | K |
| NV | 0.95 | 2.4 | C,K | 2.0 | 4.7 | C,K | 2.7 | 7.5 | D,K | 3.3 | 13 | D,K | 4.3 | 16 | K | 5.1 | 20 | K | 6.2 | 33 | K |
| BD | 0.75 | 1.8 | K | 1.5 | 3.6 | K | 2.0 | 5.6 | K | 2.7 | 11 | K | 3.3 | 13 | K | 3.9 | 15 | K | 5.1 | 27 | K |
| BC | 1.4 | 3.3 | K | 3.0 | 3.8 | K | 3.9 | 11 | K | 4.7 | 20 | K | 6.2 | 24 | K | 7.5 | 27 | K | 9.1 | 51 | K |
| BE | 1.4 | 3.3 | K | 2.7 | 6.2 | K | 3.6 | 10 | K | 4.7 | 20 | K | 6.2 | 24 | K | 6.8 | 27 | K | 9.1 | 4.7 | K |
| BL | 2.2 | 5.1 | K | 4.3 | 10 | K | 6.2 | 16 | K | 7.5 | 30 | K | 10 | 36 | K | 11 | 43 | K | 15 | 75 | K |
| BJ | 3.6 | 8.2 | K | 7.5 | 16 | K | 10 | 27 | K | 12 | 51 | K | 16 | 62 | K | 18 | 68 | K | 24 | 120 | K |
| BN | 5.1 | 12 | K | 10 | 22 | K | 13 | 39 | K | 18 | 68 | K | 22 | 82 | K | 24 | 100 | K | 33 | 160 | K |
| BU | 9.1 | 22 | M | 20 | 43 | M | 24 | 68 | M | 33 | 130 | M | 43 | 160 | M | 47 | 180 | M | 62 | 330 | M |
| BV | 15 | 36 | M | 30 | 68 | M | 39 | 110 | M | 51 | 200 | M | 68 | 240 | M | 75 | 300 | M | 100 | 510 | M |
| UX | 60 | 70 | M | 90 | 120 | M | 140 | 160 | M | 180 | 190 | M | 200 | 250 | M | 380 | 550 | M | 600 | 1,000 | M |



SLC — Bi-Cap[®]

Binary Tunable Caps for Single-Layer Hybrids.

FUNCTIONAL APPLICATIONS

- Matching Networks
- Tank Circuits
- Tuning
- Coupling

BENEFITS

- Small size compatible with microwave geometries
- Hybrid Circuits — engineering designs
- Operating frequency up to 30GHz
- Customized solutions

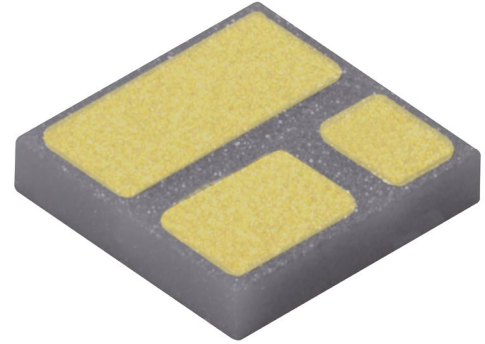

TEST LEVEL CODES

Commercial Level

| | |
|---|---|
| X | 100% 4-Side Visual 1% AQL Electrical (CAP/DF/IR & DWV) |
|---|---|

HIGH RELIABILITY

| | | | |
|---|---|---|--|
| A | MIL-PRF-49464 Group A | B | MIL-PRF-49464 Group B |
| | <ul style="list-style-type: none"> • 100% Thermal Shock • 100% Voltage Conditioning • 100% Electrical (CAP/DF/IR & DWV) • 100% 6-Side Visual • Bond Strength • Die Shear • Temperature Coefficient | | <ul style="list-style-type: none"> • MIL-PRF-49464 Group A • Immersion • Low Voltage Humidity • Life |
| | | | D |
| | | E | • 6-Side Visual |

TOLERANCE

| Code | Description |
|------|-------------------------------|
| A | ± 0.05pF |
| B | ± 0.1pF |
| C | ± 0.25pF |
| D | ± 0.50pF |
| K | ± 10% |
| L | ± 15% |
| M | ± 20% |
| X | GMV (Guarantee Minimum Value) |
| Z | +80%, -20% |

VOLTAGE

| Code | Voltage |
|------|-----------|
| 2 | 25 Volts |
| 5 | 50 Volts |
| 1 | 100 Volts |

ORDERING INFORMATION — SLC — Bi-CAP[®]

| F | 15 | NR | OR1 | M | 1 | P | X | 3 | |
|-----------------------|----------------------------|--------------------------------|---|-----------|--------------------------------|-----------------------|--|--------------|---|
| Product | Case Size | Material | Capacitance (pF) | Tolerance | Voltage | Termination | Test Level | Pad Quantity | Packaging |
| F = Binary Capacitors | 15 20 25 35 40 | See material tables on Page 5. | Lowest Value in Series is Part Number R08 = .080 pF OR1 = .1 pF OR2 = .2 pF OR4 = .4 pF OR5 = .5 pF Consult an inside sales rep for custom solutions. | M = ± 20% | 2 = 25V 5 = 50V 1 = 100V | P = Ni / Au M = Au | X See test level definitions on page 7. | 3 4 | T = Tape and Reel Leave blank for generic waffle pack. See packaging definitions on Page 8. |



SLC — Bi-Cap[®]

| Part Number | No. of Caps | Values (pF) | Voltage (WVDC) | Length | Width | Thickness | Border |
|---------------|-------------|-----------------|----------------|--|--|---|------------------|
| F15CGR08M5PX3 | 3 | 0.08, 0.15, 0.3 | 50 | 0.015" ± 0.001" (0.381mm ± 0.025mm) | 0.015" ± 0.001" (0.381mm ± 0.025mm) | 0.004" ± 0.001" (0.102mm ± 0.025mm) | 0.002" (0.051mm) |
| F15NR0R1M1PX3 | 3 | 0.1, 0.2, 0.4 | 100 | 0.015" ± 0.001" (0.381mm ± 0.025mm) | 0.015" ± 0.001" (0.381mm ± 0.025mm) | 0.006" ± 0.001" (0.152mm ± 0.025mm) | |
| F20CG0R1M1PX3 | 3 | 0.1, 0.2, 0.4 | 100 | 0.020" ± 0.001" (0.508mm ± 0.025mm) | 0.020" ± 0.001" (0.508mm ± 0.025mm) | 0.006" ± 0.001" (0.152mm ± 0.025mm) | |
| F20NR0R2M1PX3 | 3 | 0.2, 0.4, 0.8 | 100 | 0.020" ± 0.001" (0.508mm ± 0.025mm) | 0.020" ± 0.001" (0.508mm ± 0.025mm) | 0.006" ± 0.001" (0.152mm ± 0.025mm) | |
| F25CFR08M5PX3 | 3 | 0.08, 0.15, 0.3 | 50 | 0.025" ± 0.001" (0.635mm ± 0.025mm) | 0.025" ± 0.001" (0.635mm ± 0.025mm) | 0.004" ± 0.001" (0.102mm ± 0.025mm) | |
| F25CG0R2M1PX3 | 3 | 0.2, 0.4, 0.8 | 100 | 0.025" ± 0.001" (0.635mm ± 0.025mm) | 0.025" ± 0.001" (0.635mm ± 0.025mm) | 0.006" ± 0.001" (0.152mm ± 0.025mm) | |
| F25NR0R4M1PX3 | 3 | 0.4, 0.8, 1.6 | 100 | 0.025" ± 0.001" (0.635mm ± 0.025mm) | 0.025" ± 0.001" (0.635mm ± 0.025mm) | 0.006" ± 0.001" (0.152mm ± 0.025mm) | |
| F35CF0R1M1PX3 | 3 | 0.1, 0.2, 0.4 | 100 | 0.035" ± 0.001" (0.889mm ± 0.025mm) | 0.035" ± 0.001" (0.889mm ± 0.025mm) | 0.006" ± 0.001" (0.152mm ± 0.025mm) | |
| F35CG0R4M1PX3 | 3 | 0.4, 0.8, 1.6 | 100 | 0.035" ± 0.001" (0.889mm ± 0.025mm) | 0.035" ± 0.001" (0.889mm ± 0.025mm) | 0.006" ± 0.001" (0.152mm ± 0.025mm) | |
| F40NR0R5M1PX4 | 4 | 0.5, 1, 2, 4 | 100 | 0.040" ± 0.001" (1.016mm ± 0.025mm) | 0.040" ± 0.001" (1.016mm ± 0.025mm) | 0.0075" ± 0.001" (0.191mm ± 0.025mm) | |

DIMENSIONS — Bi-CAP[®]

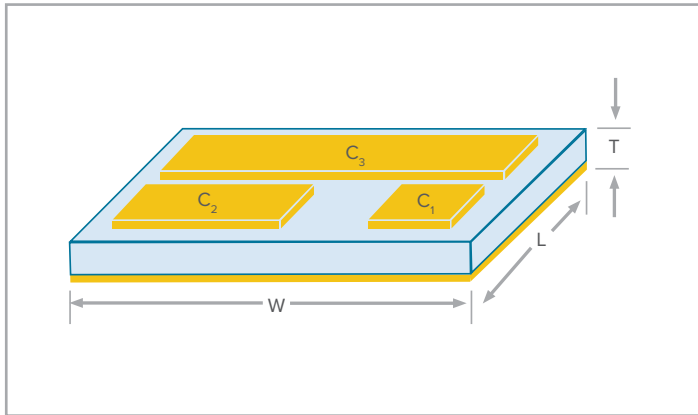

CIRCUIT DIAGRAM — Bi-CAP[®]

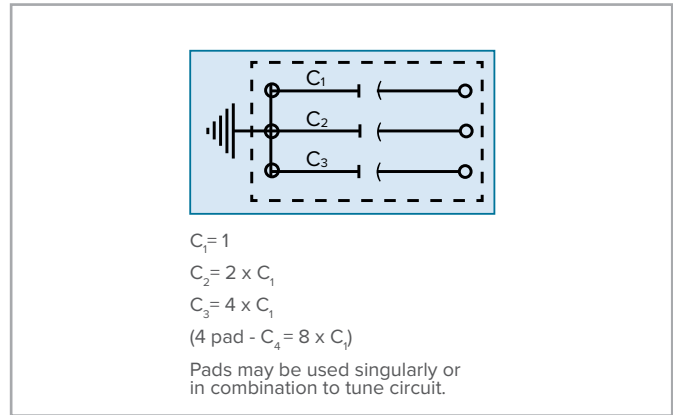

Materials and Metallization

Compex utilizes an extensive variety of materials in both Class I and Class II categories with dielectric constants ranging from 3.8 to 35,000 to fabricate our components. Other dielectric materials are available; please consult the sales office.

CLASS I DIELECTRIC MATERIALS:

This class of dielectrics consists of material exhibiting very low losses, extremely low or closely controlled temperature coefficients, negligible voltage and frequency coefficients, negligible aging effects and high insulation and dielectric breakdown.

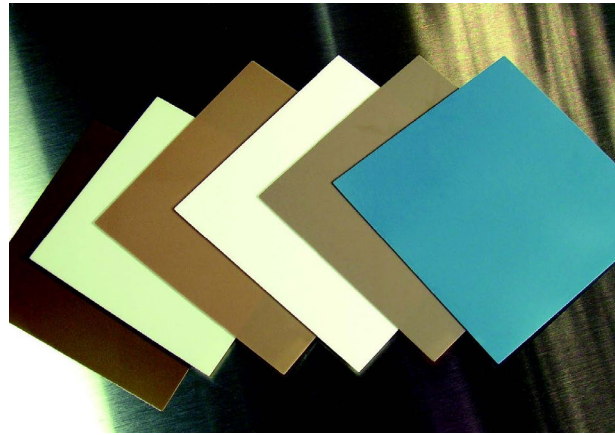

CLASS I DIELECTRIC MATERIALS

| Type | Ins. Res (MEG-OHMS 100VDC @ 25°) | Temperature Coefficient PPM°C -55 to 125°C | Dissipation Factor (@ 10GHz) | Dielectric Constant (K) | Material |
|------|-------------------------------------|---|---------------------------------|----------------------------|--------------|
| C-20 | 10 ⁶ | Negligible | 0.0001 | 3.8 | Quartz |
| C-28 | | P120 ± 25 | 0.0001 | 8.7 | AlN |
| C-30 | | P180 ± 50 | 0.0006 | 9.6 | Alumina 96 |
| C-35 | | P180 ± 50 | 0.0006 | 9.8 | Alumina 99.6 |
| C-37 | | NPO 0 ± 30 | 0.0001 | 12.6 | Titanate |
| C-40 | | 0 ± 30 | 0.0010 | 20 | Titanate |
| C-50 | | 0 ± 30 | 0.0020 | 40 | Titanate |
| C-55 | | 0 ± 30 | 0.0050 | 50 | Titanate |
| C-58 | | 0 ± 30 | 0.0050 | 93 | Titanate |
| NR | | N1500 ± 500 | 0.0025 | 150 | Titanate |

Typically used for submounts and substrates only.

CLASS II DIELECTRIC MATERIALS:

This class of material is characterized by high dielectric constants, increased losses, and higher temperature coefficients. These properties are inherent with this class of material, but the high dielectric constants permit the use of smaller size to achieve low series inductance and meet dimensional requirements. Capacitors made with these materials are often used for coupling of microstrip line circuits where the small chip size is necessary. Used as bypass capacitors, the small size provides low series inductance and dielectric losses are typically of little concern.

CLASS II DIELECTRIC MATERIALS

| Type | Ins. Res (MEG-OHMS 100VDC @ 25°) | Temperature Coefficient (%) -55 to 125°C | Dissipation Factor (@ 1MHz) | Aging (%) HR/ Decade | Dielectric Constant (K) |
|-------|-------------------------------------|---|--------------------------------|-------------------------|----------------------------|
| C-80 | 10 ⁵ | 5 to -10 | 0.010 | 2.0 | 300 |
| BD | 10 ⁴ | -10 to 10 | 0.025 | 3.0 | 800 |
| C-BE | 10 ⁴ | -10 to 10 | 0.025 | 3.0 | 1,250 |
| C-100 | 10 ⁵ | 3 to -10 | 0.015 | 3.5 | 2,200 |
| C-120 | 10 ⁵ | 0 to -35 | 0.020 | 3.0 | 3,500 |
| C-BN | 10 ⁵ | -15 to 15 | 0.030 | 3.0 | 4,400 |
| C-140 | 10 ⁵ | 0 to -80 | 0.025 | 3.0 | 11,000 |
| C-200 | * | -15 to 15 | 0.035 | 3.0 | 25,000 |
| C-400 | * | -15 to 15 | 0.035 | 3.0 | 35,000 |

* Please consult the factory for specific ratings to meet your application requirements.

Note: MHz @1V <100pF, 1kHz @1V >100pF Voltage Rating: ≤5 mils thick-50 WVDC (25 WVDC for 200 material), >5 mils thick-100 WVDC (50 WVDC for 200 material). Insulation Resistance tested at 50 volts for all materials except C-200. C-200 tested at WVDC that is 16-25V for ≤6 mils thick and 25-50V for >6 mils.

NEW MATERIAL

C-400: Ultra High K X7R material.
Capacitance change ± 15% from -55 to 125°C.
200pF in a 10 x 10 size.
1,000pF in a 25 x 25 size.

SUBSTRATES CAN BE SUPPLIED AS FOLLOWS:

- Metallized
 - gold over platinum, palladium or nickel
 - silver over platinum
 - custom schemes and patterns to customer specifications
- Thickness range: mils and up
- Length and Width: up to 4" depending on material

STANDARD ELECTRODE METALLIZATIONS

GOLD (G): This metallization consists of a minimum of 70 micro-inches of gold over non-magnetic leach-resistant nickel or platinum, which is ideal for all wire bonding methodologies. Please consult our factory for optimum metallization options for solder applications.

SILVER (S): This metallization consists of 20 micro-inches of silver over platinum, which is ideal for all solder applications whenever the use of gold is unacceptable.

Typical Temperature Characteristics

C-30/C-37/C-40/C-50/C-55/C-58

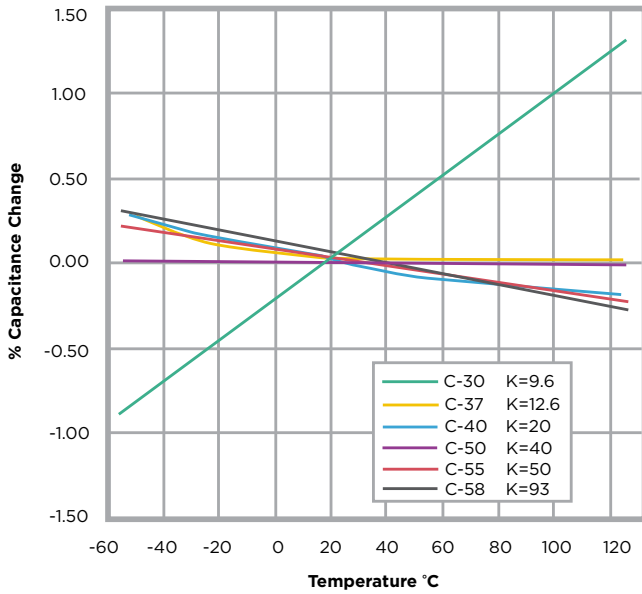

C-NR/C-80/C-BD (C-BE)/C-100

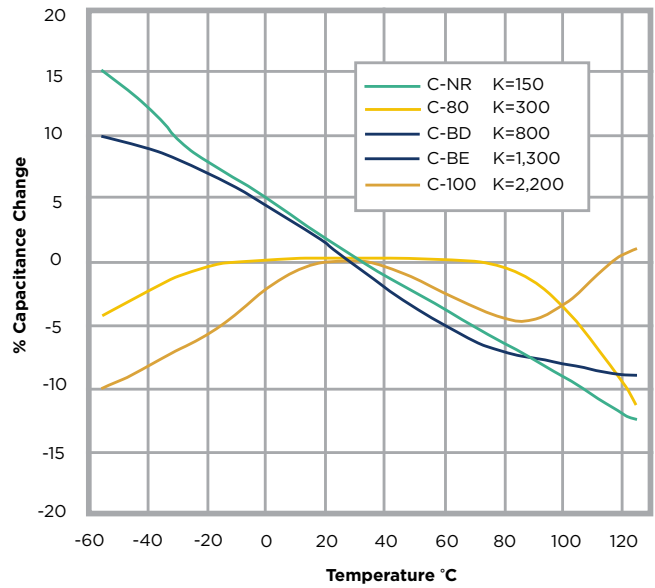

C-120/C-BN/C-140

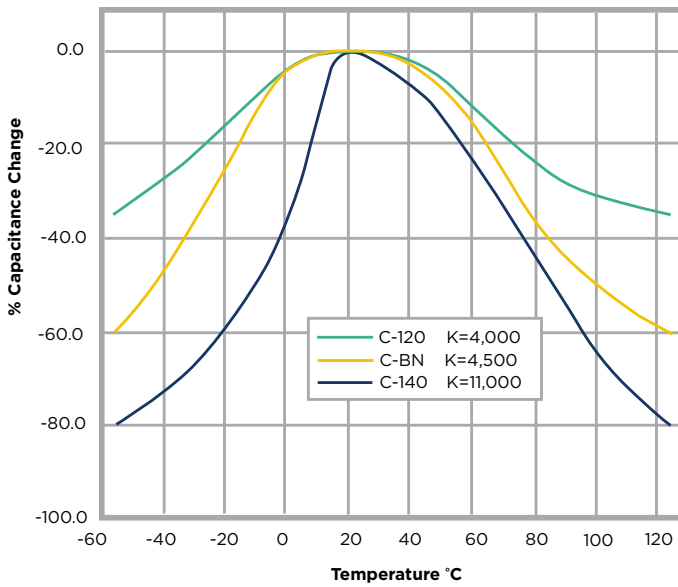

C-200/C-400

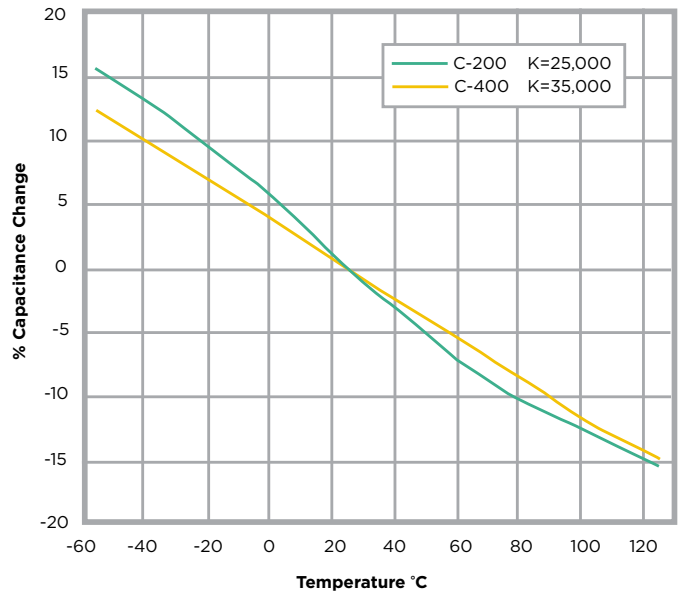

CSA Series — Edge-to-Edge Capacitors

This classic two-electrode design is the simplest and most widely used. The chip size, shape and electrical properties may be determined from the dielectric material data and the CSA Selection Chart. Complex is the leader in supplying the LC filter market with custom value parallel plate capacitors. We manufacture tight tolerance, custom filter capacitors to the required size, shape and value for minimization of post build tuning requirements. Thicknesses of up to 25+ mils are available, utilizing temperature-stable low-loss materials and special terminations to improve the all solder process.



DESCRIPTION

- Capacitance: 0.04 to 10,000 picofarads and beyond
- Square or rectangle, length or width .005" and up

CSA STANDARD CAPACITANCE TOLERANCE CODES

| Class I Dielectrics: C-20 thru C-NR | | | | Class II Dielectrics: C-80 thru C-400 | | | |
|-------------------------------------|------|-----------|------|---------------------------------------|------|-----------|------|
| Tolerance | Code | Tolerance | Code | Tolerance | Code | Tolerance | Code |
| ±.50pF | D | ± 20% | M | -20% thru +80% | Z | ± 20% | M |
| ±.25pF | C | ± 15% | L | -10% thru +40% | Y | ± 15% | L |
| ±.10pF | B | ± 10% | K | -0% thru +100% | V | ± 10% | K |
| ±.05pF | A | ± 5% | J | Guaranteed Min. Value | GMV | ± 5% | J |
| ±.01pF | P | ± 3% | H | - | - | - | - |
| - | - | ± 2% | G | - | - | - | - |

CSA CHIP DIMENSIONS

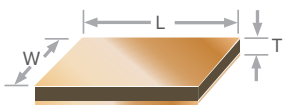

To determine rectangular chip dimensions, divide the total chip area by the required length or width to obtain the remaining dimension.

CSA STANDARD DIMENSIONAL TOLERANCES

| Material | L or W Dimension | Tolerance |
|--------------------|---------------------|-----------|
| C-20 through C-140 | < 20 mils | ± 15% |
| | ≥ 20 mils | ± 10% |
| C-200 and C-400 | ≤ 15 mils | ± 2 mils |
| | >15 mils; ≤ 30 mils | ± 3 mils |
| | > 30 mils | ± 5 mils |

CSA ELECTRODE CONFIGURATION

Two electrodes



ORDERING INFORMATION — CSA SERIES — EDGE-TO-EDGE CAPACITORS

| CSA Cap Style | 200 Dielectric Type | 10 x 10 Length x Width (mils) | x 6 Thickness (mils) | G Metallization | 101 Capacitance (pF) | M Capacitance Tolerance |
|---------------|---|------------------------------------|------------------------------------|----------------------------------|---|--|
| - | See Class I and Class II tables (page 26) | See CSA Chip Dimensions (at right) | See CSA Selection Chart (at right) | G = Gold S = Silver Custom | First two digits represent significant figures and the last, the number of zeros to follow. When required, the letter "R" is used as a decimal point and the succeeding digits represent significant figures only. e.g.: 101 = 100pF, 1R6 = 1.6pF | See CSA Standard Capacitance Tolerance Codes (below) |

Note: Standard dimensional tolerance for length and width is ±15% up to 20 mils. For dimensions greater than 20 mils, standard tolerance is ±10%. For C-200 and C-400 material, see table on right. In cases where dimensions cannot be exceeded, insert "M" to signify a Maximum dimension. The thickness tolerance is ±1.5 mils.

Example shown: Complex Series CSM, dielectric type C-BD/BE, .010" x .010" x .005", gold, 2.7pF, ±20% tolerance

Please contact factory to request free samples.

CSA Series — Edge-to-Edge Capacitors

CSA SELECTION CHART

Note: Selection Chart is for guidance only. All Compex parts are built to specific customer requirements.

Capacitor Size in Mils (mm)

| Cap. (pF) | 10x10 (.254x.254) | | 12x12 (.305x.305) | | 15x15 (.381x.381) | | 20x20 (.508x.508) | | 25x25 (.635x.635) | | 30x30 (.762x.762) | | 35x35 (.889x.889) | | 40x40 (1.016x1.016) | | 50x50 (1.27x1.27) | | |
|--------------|-------------------|--------|-------------------|--------|-------------------|--------|-------------------|--------|-------------------|--------|-------------------|--------|-------------------|--------|---------------------|--------|-------------------|--------|--|
| | Diel. | Thick. | Diel. | Thick. | Diel. | Thick. | Diel. | Thick. | Diel. | Thick. | Diel. | Thick. | Diel. | Thick. | Diel. | Thick. | Diel. | Thick. | |
| 0.04 | C-30 | 5 | C-30 | 6 | C-30 | 10 | | | | | | | | | | | | | |
| 0.06 | C-30 | 4 | C-30 | 5 | C-30 | 8 | C-20 | 5 | C-20 | 10 | | | | | | | | | |
| 0.08 | C-50 | 10 | C-30 | 4 | C-30 | 6 | C-30 | 10 | C-20 | 7 | C-20 | 9 | | | | | | | |
| 0.1 | C-50 | 8 | C-50 | 11 | C-30 | 5 | C-30 | 9 | C-20 | 5 | C-20 | 7 | C-20 | 10 | | | | | |
| 0.2 | C-50 | 5 | C-50 | 7 | C-50 | 10 | C-30 | 4 | C-30 | 7 | C-30 | 10 | C-20 | 5 | C-20 | 7 | C-20 | 10 | |
| 0.3 | C-58 | 6 | C-50 | 4 | C-50 | 6 | C-50 | 11 | C-30 | 4 | C-30 | 7 | C-30 | 9 | C-20 | 5 | C-20 | 7 | |
| 0.4 | C-58 | 5 | C-58 | 7 | C-50 | 5 | C-50 | 9 | C-50 | 15 | C-30 | 5 | C-30 | 7 | C-30 | 9 | C-20 | 5 | |
| 0.5 | C-58 | 4 | C-58 | 5 | C-50 | 4 | C-50 | 7 | C-50 | 11 | C-30 | 5 | C-30 | 5 | C-30 | 7 | C-20 | 4 | |
| 0.6 | C-NR | 6 | C-58 | 5 | C-58 | 7 | C-50 | 6 | C-50 | 10 | C-50 | 15 | C-30 | 4 | C-30 | 6 | C-30 | 9 | |
| 0.8 | C-80 | 8 | C-NR | 6 | C-58 | 5 | C-50 | 5 | C-50 | 7 | C-50 | 10 | C-50 | 15 | C-30 | 4 | C-30 | 7 | |
| 1 | C-80 | 7 | C-NR | 5 | C-58 | 4 | C-58 | 7 | C-50 | 6 | C-50 | 8 | C-50 | 10 | C-30 | 4 | C-30 | 5 | |
| 1.2 | C-80 | 6 | C-NR | 4 | C-58 | 4 | C-58 | 6 | C-50 | 5 | C-50 | 7 | C-50 | 9 | C-30 | 3 | C-30 | 5 | |
| 1.5 | C-80 | 5 | C-80 | 7 | C-NR | 5 | C-58 | 5 | C-50 | 4 | C-50 | 6 | C-50 | 7 | C-50 | 10 | C-30 | 4 | |
| 1.8 | C-80 | 4 | C-80 | 5 | C-NR | 4 | C-58 | 4 | C-58 | 6 | C-50 | 5 | C-50 | 6 | C-50 | 8 | C-50 | 11 | |
| 2 | C-80 | 4 | C-80 | 5 | C-NR | 4 | C-NR | 7 | C-58 | 6 | C-50 | 4 | C-50 | 5 | C-50 | 7 | C-50 | 11 | |
| 2.2 | C-BD/ BE | 4 | C-80 | 5 | C-NR | 4 | C-NR | 6 | C-58 | 5 | C-58 | 7 | C-50 | 5 | C-50 | 7 | C-50 | 10 | |
| 2.7 | C-BD/ BE | 8 | C-80 | 4 | C-80 | 6 | C-NR | 5 | C-58 | 4 | C-58 | 6 | C-50 | 4 | C-50 | 5 | C-50 | 8 | |
| 3.3 | C-BD/ BE | 7 | C-BD/ BE | 10 | C-80 | 5 | C-NR | 4 | C-NR | 6 | C-58 | 5 | C-58 | 7 | C-50 | 4 | C-50 | 7 | |
| 3.9 | C-BD/ BE | 6 | C-BD/ BE | 9 | C-80 | 4 | C-80 | 7 | C-NR | 5 | C-58 | 4 | C-58 | 6 | C-58 | 8 | C-50 | 6 | |
| 4.7 | C-BD/ BE | 5 | C-BD/ BE | 7 | C-BD/ BE | 11 | C-80 | 6 | C-NR | 4 | C-NR | 6 | C-58 | 5 | C-58 | 6 | C-50 | 5 | |
| 5.6 | C-BD/ BE | 4 | C-BD/ BE | 6 | C-BD/ BE | 10 | C-80 | 4 | C-80 | 7 | C-NR | 5 | C-58 | 4 | C-58 | 5 | C-50 | 4 | |
| 6.8 | C-BD/ BE | 4 | C-BD/ BE | 5 | C-BD/ BE | 8 | C-80 | 4 | C-80 | 6 | C-NR | 5 | C-NR | 6 | C-58 | 4 | C-58 | 7 | |
| 8.2 | C-100 | 6 | C-BD/ BE | 4 | C-BD/ BE | 7 | C-80 | 4 | C-80 | 5 | C-NR | 4 | C-NR | 5 | C-NR | 7 | C-NR | 10 | |
| 10 | C-100 | 5 | C-BD/ BE | 4 | C-BD/ BE | 5 | C-BD/ BE | 9 | C-80 | 4 | C-80 | 6 | C-NR | 4 | C-NR | 5 | C-NR | 8 | |
| 12 | C-100 | 4 | C-100 | 6 | C-BD/ BE | 5 | C-BD/ BE | 8 | C-BD/ BE | 11 | C-80 | 5 | C-80 | 7 | C-NR | 4 | C-NR | 7 | |
| 15 | C-120 | 6 | C-100 | 5 | C-BD/ BE | 4 | C-BD/ BE | 6 | C-BD/ BE | 10 | C-80 | 4 | C-80 | 6 | C-80 | 7 | C-NR | 6 | |
| 18 | C-120 | 5 | C-100 | 4 | C-100 | 6 | C-BD/ BE | 5 | C-BD/ BE | 8 | C-BD/ BE | 11 | C-80 | 4 | C-80 | 6 | C-NR | 5 | |
| 20 | C-120 | 5 | C-100 | 4 | C-100 | 6 | C-BD/ BE | 5 | C-BD/ BE | 8 | C-BD/ BE | 11 | C-80 | 4 | C-80 | 5 | C-NR | 4 | |



CSA Series — Edge-to-Edge Capacitors

CONTINUED

Capacitor Size in Mils (mm)

| Cap. (pF) | 10x10 (.254x.254) | | 12x12 (.305x.305) | | 15x15 (.381x.381) | | 20x20 (.508x.508) | | 25x25 (.635x.635) | | 30x30 (.762x.762) | | 35x35 (.889x.889) | | 40x40 (1.016x1.016) | | 50x50 (1.27x1.27) | | | | | |
|--------------|----------------------|--------|-------------------|--------|-------------------|--------|-------------------|--------|-------------------|--------|-------------------|--------|-------------------|--------|---------------------|--------|-------------------|--------|---|-------|-------|---|
| | Diel. | Thick. | Diel. | Thick. | Diel. | Thick. | Diel. | Thick. | Diel. | Thick. | Diel. | Thick. | Diel. | Thick. | Diel. | Thick. | Diel. | Thick. | | | | |
| 22 | C-120 | 4 | C-120 | 6 | C-100 | 5 | C-BD/BE | 4 | C-BD/BE | 7 | C-BD/BE | 9 | C-80 | 4 | C-80 | 5 | C-NR | 4 | | | | |
| 27 | C-120 | 4 | C-120 | 5 | C-100 | 4 | C-BD/BE | 4 | C-BD/BE | 6 | C-BD/BE | 8 | C-80 | 3 | C-80 | 4 | C-80 | 6 | | | | |
| 33 | C-BN | 4 | C-120 | 4 | C-120 | 6 | C-100 | 6 | C-BD/BE | 5 | C-BD/BE | 6 | C-BD/BE | 11 | C-80 | 4 | C-80 | 5 | | | | |
| 39 | C-140 | 6 | C-120 | 4 | C-120 | 5 | C-100 | 5 | C-BD/BE | 4 | C-BD/BE | 5 | C-BD/BE | 7 | C-BD/BE | 10 | C-80 | 4 | | | | |
| 47 | C-140 | 5 | C-140 | 7 | C-120 | 5 | C-100 | 4 | C-100 | 6 | C-BD/BE | 5 | C-BD/BE | 6 | C-BD/BE | 8 | C-80 | 4 | | | | |
| 56 | C-140 | 4 | C-140 | 6 | C-BN | 5 | C-120 | 7 | C-100 | 5 | C-BD/BE | 4 | C-BD/BE | 5 | C-BD/BE | 7 | C-BD/BE | 10 | | | | |
| 68 | C-140 | 4 | C-140 | 5 | C-BN | 4 | C-120 | 6 | C-100 | 5 | C-100 | 6 | C-BD/BE | 4 | C-BD/BE | 6 | C-BD/BE | 9 | | | | |
| 82 | C-200 | 7 | C-140 | 4 | C-140 | 7 | C-BN | 6 | C-100 | 4 | C-100 | 5 | C-100 | 7 | C-100 | 10 | C-BD/BE | 7 | | | | |
| 100 | C-200 | 6 | C-200 | 8 | C-140 | 6 | C-BN | 5 | C-120 | 6 | C-100 | 5 | C-100 | 6 | C-100 | 8 | C-BD/BE | 6 | | | | |
| 120 | C-200 | 5 | C-200 | 7 | C-140 | 5 | C-140 | 8 | C-BN | 6 | C-100 | 4 | C-100 | 5 | C-100 | 7 | C-BD/BE | 5 | | | | |
| 150 | C-200 | 4 | C-200 | 5 | C-140 | 4 | C-140 | 7 | C-BN | 5 | C-BN | 7 | C-100 | 4 | C-100 | 5 | C-BD/BE | 4 | | | | |
| 180 | C-400 | 4 | C-200 | 5 | C-200 | 7 | C-140 | 6 | C-BN | 4 | C-BN | 6 | C-BN | 8 | C-120 | 8 | C-100 | 7 | | | | |
| 200 | C-400 | 4 | C-200 | 4 | C-200 | 6 | C-140 | 5 | C-140 | 8 | C-BN | 5 | C-BN | 7 | C-120 | 7 | C-100 | 6 | | | | |
| 220 | C-400 | 4 | C-400 | 5 | C-200 | 6 | C-140 | 4 | C-140 | 7 | C-BN | 5 | C-BN | 6 | C-120 | 6 | C-100 | 6 | | | | |
| 270 | | | C-400 | 4 | C-200 | 5 | C-200 | 8 | C-140 | 6 | C-BN | 4 | C-BN | 5 | C-120 | 5 | C-100 | 5 | | | | |
| 330 | | | | | C-200 | 4 | C-200 | 7 | C-140 | 5 | C-140 | 7 | C-BN | 4 | C-120 | 4 | C-120 | 7 | | | | |
| 390 | | | | | C-400 | 5 | C-200 | 6 | C-140 | 4 | C-140 | 6 | C-140 | 7 | C-140 | 10 | C-120 | 6 | | | | |
| 470 | | | | | C-400 | 4 | C-200 | 5 | C-200 | 7 | C-140 | 5 | C-140 | 6 | C-140 | 8 | C-120 | 5 | | | | |
| 560 | | | | | | | C-200 | 4 | C-200 | 6 | C-140 | 4 | C-140 | 5 | C-140 | 7 | C-120 | 4 | | | | |
| 680 | | | | | | | C-400 | 5 | C-200 | 5 | C-200 | 8 | C-140 | 5 | C-140 | 6 | C-BN | 4 | | | | |
| 820 | | | | | | | C-400 | 4 | C-400 | 6 | C-200 | 6 | C-140 | 4 | C-140 | 5 | C-140 | 7 | | | | |
| 1000 | | | | | | | | | C-400 | 5 | C-200 | 5 | C-200 | 7 | C-140 | 4 | C-140 | 6 | | | | |
| 1200 | | | | | | | | | C-400 | 4 | C-200 | 4 | C-200 | 6 | C-200 | 7 | C-140 | 5 | | | | |
| 1500 | Class II Dielectrics | | | | | | | | | | C-400 | 5 | C-200 | 5 | C-200 | 6 | C-140 | 4 | | | | |
| 1800 | | | | | | | | | | | | | | C-400 | 4 | C-400 | 6 | C-200 | 5 | C-200 | 8 | |
| 2200 | | | | | | | | | | | | | | | | C-400 | 5 | C-200 | 4 | C-200 | 6 | |
| 2700 | | | | | | | | | | | | | | | | C-400 | 4 | C-400 | 5 | C-200 | 5 | |
| 3300 | | | | | | | | | | | | | | | | | | | | | C-400 | 6 |



CSM Series — Margin Capacitors

Margin caps have the topside electrode withdrawn from the edges in order to increase the distance between electrodes and dramatically decrease the possibilities of shorting when epoxy die-mounting. This style is also widely used for optical recognition-based assembly.

Increased margin sizes and special terminations are available for high power LC filter applications.

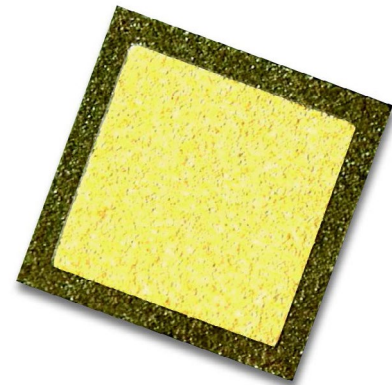

DESCRIPTION

- Margin capacitors can be customized to any sized square or rectangle



CSA STANDARD CAPACITANCE TOLERANCE CODES

Class I Dielectrics: C-20 thru C-NR

| Tolerance | Code | Tolerance | Code |
|-----------|------|-----------|------|
| ± .50pF | D | ± 20% | M |
| ± .25pF | C | ± 15% | L |
| ± .10pF | B | ± 10% | K |
| ± .05pF | A | ± 5% | J |
| ± .01pF | P | ± 3% | H |
| - | - | ± 2% | G |

Class II Dielectrics: C-80 thru C-400

| Tolerance | Code | Tolerance | Code |
|-----------------------|------|-----------|------|
| -20% thru +80% | Z | ± 20% | M |
| -10% thru +40% | Y | ± 15% | L |
| -0% thru +100% | V | ± 10% | K |
| Guaranteed Min. Value | GMV | ± 5% | J |
| - | - | - | - |
| - | - | - | - |

CSM CHIP DIMENSIONS

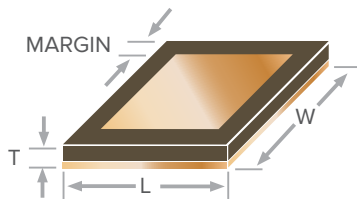

CSM STANDARD DIMENSIONAL TOLERANCES

| Length & Width | L or W Tolerance | Margin Nominal | Thickness |
|---------------------------------|------------------|----------------|-----------|
| ≤.010 | ± .002 | .001 | ± .0015 |
| .011 thru .029 | ± .002 | .002 | |
| ≥.030 | ± .003 | .002 | |
| All dimensions given are inches | | | |

CSM ELECTRODE CONFIGURATION

Two electrodes



ORDERING INFORMATION — CSA SERIES — MARGIN CAPACITORS

| CSM Style | 90 Dielectric Type | 10 x 10 Length x Width (mils) | x 5 Thickness (mils) | G Metallization | 2R7 Capacitance (pF) | M Capacitance Tolerance |
|-----------|---|------------------------------------|------------------------------------|-----------------|---|--|
| - | See Class I and Class II tables (page 26) | See CSA Chip Dimensions (at right) | See CSA Selection Chart (at right) | G = Gold | First two digits represent significant figures and the last, the number of zeros to follow. When required, the letter "R" is used as a decimal point and the succeeding digits represent significant figures only. e.g.: 101 = 100pF, 1R6 = 1.6pF | See CSM Standard Capacitance Tolerance Codes (below) |

Example shown: Complex Series CSM, dielectric type C-BD/BE, .010" x .010" x .005", gold, 2.7pF, ±20% tolerance

Please contact factory to request free samples.



CSM Series — Margin Capacitors

CSM SELECTION CHART

Note: Selection Chart is for guidance only. All Compex parts are built to specific customer requirements.

Capacitor Size in Mils (mm)

| Cap. (pF) | 10x10 (.254x.254) | | 12x12 (.305x.305) | | 15x15 (.381x.381) | | 20x20 (.508x.508) | | 25x25 (.635x.635) | | 30x30 (.762x.762) | | 35x35 (.889x.889) | | 40x40 (1.016x1.016) | | 50x50 (1.27x1.27) | | | | |
|--------------|-------------------|--------|-------------------|--------|-------------------|--------|-------------------|--------|-------------------|--------|-------------------|--------|-------------------|--------|---------------------|--------|-------------------|--------|--|--|--|
| | Diel. | Thick. | Diel. | Thick. | Diel. | Thick. | Diel. | Thick. | Diel. | Thick. | Diel. | Thick. | Diel. | Thick. | Diel. | Thick. | Diel. | Thick. | | | |
| 0.04 | C-30 | 4 | C-30 | 4 | C-30 | 5 | C-20 | 5 | | | | | | | Class I Dielectrics | | | | | | |
| 0.06 | C-50 | 10 | C-30 | 4 | C-30 | 6 | C-20 | 5 | C-20 | 8 | C-20 | 10 | | | | | | | | | |
| 0.08 | C-50 | 7 | C-50 | 10 | C-30 | 5 | C-30 | 10 | C-20 | 6 | C-20 | 8 | C-20 | 11 | | | | | | | |
| 0.1 | C-50 | 6 | C-50 | 9 | C-50 | 4 | C-30 | 7 | C-20 | 5 | C-20 | 7 | C-20 | 10 | | | | | | | |
| 0.2 | C-58 | 4 | C-50 | 4 | C-50 | 5 | C-30 | 4 | C-30 | 5 | C-30 | 7 | C-20 | 4 | C-20 | 5 | C-20 | 10 | | | |
| 0.3 | C-NR | 6 | C-58 | 5 | C-58 | 4 | C-50 | 8 | C-30 | 4 | C-30 | 5 | C-30 | 7 | C-20 | 4 | C-20 | 6 | | | |
| 0.4 | C-NR | 4 | C-58 | 4 | C-58 | 6 | C-50 | 6 | C-50 | 10 | C-30 | 4 | C-30 | 5 | C-30 | 7 | C-20 | 5 | | | |
| 0.5 | C-80 | 5 | C-NR | 4 | C-58 | 5 | C-50 | 4 | C-50 | 7 | C-50 | 10 | C-30 | 4 | C-30 | 6 | C-30 | 10 | | | |
| 0.6 | C-80 | 5 | C-NR | 5 | C-NR | 4 | C-50 | 4 | C-50 | 6 | C-50 | 10 | C-30 | 4 | C-30 | 5 | C-30 | 7 | | | |
| 0.8 | C-80 | 5 | C-80 | 5 | C-NR | 5 | C-58 | 6 | C-50 | 5 | C-50 | 7 | C-50 | 10 | C-30 | 4 | C-30 | 6 | | | |
| 1 | C-80 | 4 | C-80 | 5 | C-NR | 4 | C-58 | 5 | C-50 | 4 | C-50 | 6 | C-50 | 8 | C-50 | 10 | C-30 | 5 | | | |
| 1.2 | C-BD/ BE | 6 | C-80 | 5 | C-80 | 7 | C-58 | 4 | C-58 | 7 | C-50 | 5 | C-50 | 7 | C-50 | 10 | C-30 | 4 | | | |
| 1.5 | C-BD/ BE | 7 | C-80 | 4 | C-80 | 6 | C-NR | 6 | C-58 | 6 | C-58 | 8 | C-50 | 6 | C-50 | 7 | C-50 | 15 | | | |
| 1.8 | C-BD/ BE | 6 | C-80 | 4 | C-80 | 5 | C-NR | 5 | C-58 | 5 | C-58 | 7 | C-50 | 5 | C-50 | 7 | C-50 | 10 | | | |
| 2 | C-BD/ BE | 6 | C-BD/ BE | 8 | C-80 | 4 | C-NR | 5 | C-58 | 5 | C-58 | 6 | C-50 | 4 | C-50 | 6 | C-50 | 10 | | | |
| 2.2 | C-BD/ BE | 5 | C-BD/ BE | 7 | C-80 | 4 | C-80 | 7 | C-NR | 7 | C-58 | 6 | C-50 | 4 | C-50 | 5 | C-50 | 10 | | | |
| 2.7 | C-BD/ BE | 5 | C-BD/ BE | 6 | C-80 | 4 | C-80 | 6 | C-NR | 6 | C-58 | 6 | C-58 | 8 | C-50 | 5 | C-50 | 8 | | | |
| 3.3 | C-100 | 6 | C-BD/ BE | 6 | C-BD/ BE | 8 | C-80 | 5 | C-NR | 5 | C-58 | 4 | C-58 | 6 | C-58 | 7 | C-50 | 6 | | | |
| 3.9 | C-100 | 5 | C-BD/ BE | 5 | C-BD/ BE | 7 | C-80 | 4 | C-NR | 4 | C-NR | 6 | C-58 | 5 | C-58 | 6 | C-50 | 5 | | | |
| 4.7 | C-100 | 5 | C-BD/ BE | 5 | C-BD/ BE | 7 | C-80 | 4 | C-80 | 6 | C-NR | 5 | C-58 | 4 | C-58 | 5 | C-58 | 8 | | | |
| 5.6 | C-100 | 5 | C-100 | 6 | C-BD/ BE | 5 | C-80 | 4 | C-80 | 5 | C-NR | 4 | C-NR | 6 | C-58 | 5 | C-58 | 7 | | | |
| 6.8 | C-120 | 5 | C-100 | 6 | C-BD/ BE | 5 | C-BD/ BE | 8 | C-80 | 5 | C-80 | 7 | C-NR | 5 | C-NR | 7 | C-58 | 6 | | | |
| 8.2 | C-120 | 4 | C-100 | 5 | C-BD/ BE | 4 | C-BD/ BE | 7 | C-80 | 4 | C-80 | 6 | C-NR | 4 | C-NR | 5 | C-58 | 5 | | | |
| 10 | C-120 | 5 | C-100 | 4 | C-100 | 6 | C-BD/ BE | 6 | C-80 | 4 | C-80 | 5 | C-80 | 6 | C-NR | 5 | C-58 | 4 | | | |
| 12 | C-120 | 5 | C-120 | 6 | C-100 | 5 | C-BD/ BE | 5 | C-BD/ BE | 8 | C-80 | 4 | C-80 | 6 | C-NR | 4 | C-NR | 6 | | | |
| 15 | C-120 | 4 | C-120 | 5 | C-100 | 5 | C-BD/ BE | 5 | C-BD/ BE | 7 | C-80 | 4 | C-80 | 5 | C-80 | 6 | C-NR | 5 | | | |
| 18 | C-BN | 4 | C-BN | 6 | C-120 | 7 | C-100 | 7 | C-BD/ BE | 5 | C-BD/ BE | 9 | C-80 | 4 | C-80 | 5 | C-NR | 4 | | | |
| 20 | C-140 | 5 | C-BN | 5 | C-120 | 6 | C-100 | 6 | C-BD/ BE | 5 | C-BD/ BE | 8 | C-80 | 4 | C-80 | 5 | C-NR | 4 | | | |



CSM Series — Margin Capacitors

CONTINUED

Capacitor Size in Mils (mm)

| Cap. (pF) | 10x10 (.254x.254) | | 12x12 (.305x.305) | | 15x15 (.381x.381) | | 20x20 (.508x.508) | | 25x25 (.635x.635) | | 30x30 (.762x.762) | | 35x35 (.889x.889) | | 40x40 (1.016x1.016) | | 50x50 (1.27x1.27) | |
|--------------|-------------------|--------|-------------------|--------|-------------------|--------|-------------------|--------|-------------------|--------|-------------------|--------|-------------------|--------|---------------------|--------|-------------------|--------|
| | Diel. | Thick. | Diel. | Thick. | Diel. | Thick. | Diel. | Thick. | Diel. | Thick. | Diel. | Thick. | Diel. | Thick. | Diel. | Thick. | Diel. | Thick. |
| 22 | C-140 | 7 | C-BN | 4 | C-120 | 5 | C-100 | 6 | C-BD/BE | 5 | C-BD/BE | 7 | C-BD/BE | 10 | C-80 | 4 | C-80 | 6 |
| 27 | C-140 | 6 | C-BN | 4 | C-BN | 5 | C-100 | 5 | C-BD/BE | 4 | C-BD/BE | 6 | C-BD/BE | 8 | C-80 | 4 | C-80 | 5 |
| 33 | C-140 | 5 | C-140 | 6 | C-BN | 4 | C-100 | 4 | C-100 | 6 | C-BD/BE | 5 | C-BD/BE | 7 | C-BD/BE | 9 | C-80 | 5 |
| 39 | C-140 | 4 | C-140 | 5 | C-BN | 4 | C-120 | 6 | C-100 | 6 | C-BD/BE | 4 | C-BD/BE | 6 | C-BD/BE | 8 | C-80 | 4 |
| 47 | C-200 | 8 | C-140 | 5 | C-140 | 6 | C-120 | 5 | C-100 | 5 | C-100 | 7 | C-BD/BE | 5 | C-BD/BE | 7 | C-BD/BE | 11 |
| 56 | C-200 | 6 | C-140 | 4 | C-140 | 5 | C-BN | 5 | C-100 | 4 | C-100 | 6 | C-BD/BE | 4 | C-BD/BE | 6 | C-BD/BE | 9 |
| 68 | C-200 | 5 | C-200 | 8 | C-140 | 5 | C-BN | 4 | C-120 | 6 | C-100 | 5 | C-BD/BE | 4 | C-BD/BE | 5 | C-BD/BE | 7 |
| 82 | C-400 | 6 | C-200 | 6 | C-140 | 4 | C-BN | 4 | C-120 | 5 | C-100 | 4 | C-100 | 6 | C-BD/BE | 4 | C-BD/BE | 6 |
| 100 | C-400 | 5 | C-200 | 6 | C-140 | 4 | C-140 | 6 | C-BN | 5 | C-120 | 6 | C-100 | 5 | C-100 | 7 | C-BD/BE | 5 |
| 120 | | | C-200 | 5 | C-200 | 6 | C-140 | 5 | C-BN | 4 | C-BN | 6 | C-100 | 4 | C-100 | 5 | C-BD/BE | 4 |
| 150 | | | C-200 | 6 | C-200 | 6 | C-140 | 4 | C-140 | 7 | C-BN | 5 | C-BN | 7 | C-100 | 4 | C-100 | 7 |
| 180 | | | C-400 | 5 | C-200 | 5 | C-140 | 4 | C-140 | 6 | C-BN | 4 | C-BN | 6 | C-100 | 4 | C-100 | 6 |
| 200 | | | | | C-400 | 5 | C-140 | 4 | C-140 | 6 | C-BN | 4 | C-BN | 5 | C-120 | 6 | C-100 | 5 |
| 220 | | | | | C-400 | 5 | C-200 | 8 | C-140 | 5 | C-BN | 4 | C-BN | 5 | C-120 | 5 | C-100 | 5 |
| 270 | | | | | C-400 | 5 | C-200 | 6 | C-140 | 4 | C-140 | 7 | C-BN | 4 | C-BN | 6 | C-100 | 4 |
| 330 | | | | | | | C-200 | 5 | C-140 | 4 | C-140 | 5 | C-140 | 7 | C-BN | 5 | C-120 | 6 |
| 390 | | | | | | | C-200 | 5 | C-200 | 6 | C-140 | 5 | C-140 | 6 | C-BN | 4 | C-120 | 5 |
| 470 | | | | | | | C-200 | 4 | C-200 | 6 | C-140 | 4 | C-140 | 5 | C-140 | 7 | C-BN | 5 |
| 560 | | | | | | | C-400 | 5 | C-400 | 6 | C-140 | 4 | C-140 | 5 | C-140 | 6 | C-BN | 4 |
| 680 | | | | | | | | | C-400 | 6 | C-200 | 6 | C-140 | 4 | C-140 | 5 | C-140 | 8 |
| 820 | | | | | | | | | C-400 | 5 | C-200 | 5 | C-200 | 8 | C-140 | 4 | C-140 | 7 |
| 1000 | | | | | | | | | | | C-400 | 6 | C-200 | 6 | C-200 | 8 | C-140 | 6 |
| 1200 | | | | | | | | | | | C-400 | 5 | C-200 | 5 | C-200 | 7 | C-140 | 5 |
| 1500 | | | | | | | | | | | | | C-400 | 6 | C-400 | 5 | C-140 | 4 |
| 1800 | | | | | | | | | | | | | C-400 | 5 | C-400 | 6 | C-200 | 7 |
| 2200 | | | | | | | | | | | | | | | C-400 | 5 | C-200 | 6 |
| 2700 | | | | | | | | | | | | | | | | 5 | C-200 | 5 |
| 3300 | | | | | | | | | | | | | | | | | C-400 | 5 |



CSB Series — Dual-Pad Capacitors

A single full electrode is provided on one side of the capacitor and split electrodes on the other side. This is a three-terminal capacitor that can be used as two capacitors with a common electrode, or as serially connected capacitors so that connections may be made on one side of the chip only (surface-mount). This design is often used in microstrip coupling to eliminate lead inductance and raise the self resonance frequency.

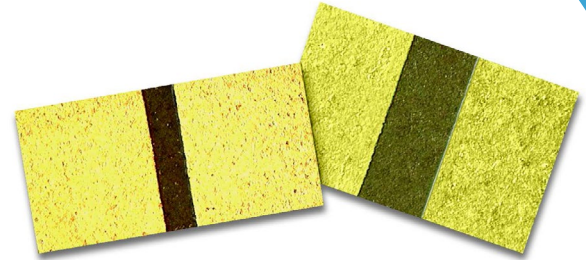

DESCRIPTION

- Capacitance: 0.06 picofarads and up
- Chip shapes: dual pads with gap
- Gap widths: 5, 10, 15, 20 mil or custom

CSA STANDARD CAPACITANCE TOLERANCE CODES

Class I Dielectrics: C-20 thru C-NR

| Tolerance | Code | Tolerance |
|-----------|------|-----------------------|
| ± 20pF | M | -10% thru +40% |
| ± 15pF | L | -20% thru +80% |
| ± 10pF | K | -0% thru +100% |
| ± 5pF | J | Guaranteed Min. Value |

Class II Dielectrics: C-80 thru C-400

| Code | Tolerance | Code |
|------|-----------|------|
| Y | ± 20% | M |
| Z | ± 15% | L |
| V | ± 10% | K |
| GMV | | |

CSB CHIP DIMENSIONS

This component functions as two capacitors operating in series, each of which is twice the desired equivalent capacitance. Allow us to custom design for your application.

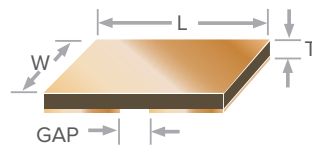

CSB ELECTRODE CONFIGURATION

Split electrodes

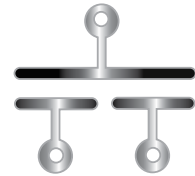

ORDERING INFORMATION — CSA SERIES — EDGE-TO-EDGE CAPACITORS

| CSB Style | 100 Dielectric Type | 50 x 20 Length x Width (mils) | x 7 Thickness (mils) | 10 Gap (mils) | G Metallization | 120 Capacitance (pF) | M Capacitance Tolerance |
|-----------|---|------------------------------------|------------------------------------|---------------|----------------------------------|---|--|
| - | See Class I and Class II tables (page 26) | See CSA Chip Dimensions (at right) | See CSA Selection Chart (at right) | 5 or higher | G = Gold S = Silver Custom | First two digits represent significant figures and the last, the number of zeros to follow. When required, the letter "R" is used as a decimal point and the succeeding digits represent significant figures only. e.g.: 101 = 100pF, 1R6 = 1.6pF | See CSB Standard Capacitance Tolerance Codes (below) |

Note: Standard dimensional tolerance for length and width is ±15% up to 20 mils. For dimensions greater than 20 mils, standard tolerance is ±10%. In cases where dimension cannot be exceeded, insert "M" to signify a Maximum dimension. The thickness tolerance is ±1.5 mils.

Example shown: Compex Series CSB, dielectric type C-100, .050" x .020" x .007", .01" gap, gold, 12pF, ±20% tolerance

Please contact factory to request free samples.



CSB Series — Dual-Pad Capacitors

CSB SELECTION CHART

Note: Selection Chart is for guidance only. All Compex parts are built to specific customer requirements.

Capacitor Size in Mils (mm)

| Cap. (pF) | 20x10 (.508x.508) | | 40x20 (1,016x.508) | | 60x30 (1,524x.762) | | 80x40 (2,032x1,016) | |
|--------------|----------------------|--------|--------------------|--------|-----------------------|--------|------------------------|--------|
| | Diel. | Thick. | Diel. | Thick. | Diel. | Thick. | Diel. | Thick. |
| 0.06 | C-50 | 6 | C-30 | 6 | C-20 | 6 | C-20 | 8 |
| 0.08 | C-50 | 4 | C-30 | 4 | C-20 | 4 | C-20 | 7 |
| 0.1 | C-58 | 7 | C-50 | 15 | C-30 | 8 | C-20 | 5 |
| 0.2 | C-NR | 6 | C-50 | 7 | C-30 | 4 | C-30 | 7 |
| 0.3 | C-80 | 8 | C-50 | 5 | C-50 | 10 | C-30 | 4 |
| 0.4 | C-80 | 6 | C-58 | 7 | C-50 | 8 | C-50 | 15 |
| 0.5 | C-80 | 5 | C-58 | 6 | C-50 | 7 | C-50 | 10 |
| 0.6 | C-80 | 4 | C-58 | 5 | C-50 | 6 | C-50 | 9 |
| 0.8 | C-BD/ BE | 11 | C-NR | 6 | C-50 | 4 | C-50 | 7 |
| 1 | C-BD/ BE | 9 | C-NR | 5 | C-58 | 7 | C-50 | 6 |
| 1.2 | C-BD/ BE | 7 | C-NR | 4 | C-58 | 6 | C-50 | 5 |
| 1.5 | C-BD/ BE | 6 | C-80 | 7 | C-58 | 5 | C-58 | 8 |
| 1.8 | C-BD/ BE | 5 | C-80 | 6 | C-58 | 4 | C-58 | 6 |
| 2 | C-BD/ BE | 4 | C-80 | 5 | C-58 | 4 | C-58 | 6 |
| 2.2 | C-BD/ BE | 4 | C-80 | 5 | C-NR | 6 | C-58 | 5 |
| 2.7 | C-100 | 7 | C-80 | 4 | C-NR | 5 | C-58 | 4 |
| 3.3 | C-100 | 6 | C-BD/ BE | 11 | C-NR | 4 | C-NR | 6 |
| 3.9 | C-100 | 5 | C-BD/ BE | 9 | C-80 | 7 | C-NR | 5 |
| 4.7 | C-100 | 4 | C-BD/ BE | 8 | C-80 | 5 | C-NR | 4 |
| 5.6 | C-120 | 6 | C-BD/ BE | 6 | C-80 | 5 | C-80 | 7 |
| 6.8 | C-120 | 5 | C-80 | 5 | C-80 | 4 | C-80 | 6 |
| 8.2 | C-BN | 5 | C-BD/ BE | 4 | C-BD/ BE | 11 | C-80 | 5 |
| 10 | C-BN | 4 | C-100 | 7 | C-BD/ BE | 9 | C-80 | 4 |
| 12 | C-140 | 8 | C-100 | 6 | C-BD/ BE | 7 | C-BD/ BE | 11 |
| 15 | C-140 | 6 | C-100 | 5 | C-BD/ BE | 6 | C-BD/ BE | 9 |

Capacitor Size in Mils (mm)

| Cap. (pF) | 20x10 (.508x.508) | | 40x20 (1,016x.508) | | 60x30 (1,524x.762) | | 80x40 (2,032x1,016) | |
|--------------|----------------------|--------|--------------------|--------|-----------------------|--------|------------------------|--------|
| | Diel. | Thick. | Diel. | Thick. | Diel. | Thick. | Diel. | Thick. |
| 18 | C-140 | 5 | C-100 | 4 | C-BD/ BE | 5 | C-BD/ BE | 8 |
| 20 | C-140 | 5 | C-120 | 7 | C-BD/ BE | 4 | C-BD/ BE | 7 |
| 22 | C-140 | 4 | C-120 | 6 | C-BD/ BE | 4 | C-BD/ BE | 6 |
| 27 | C-200 | 8 | C-120 | 5 | C-100 | 7 | C-BD/ BE | 5 |
| 33 | C-200 | 6 | C-BN | 5 | C-100 | 6 | C-100 | 9 |
| 39 | C-200 | 5 | C-BN | 4 | C-100 | 5 | C-100 | 8 |
| 47 | C-400 | 6 | C-140 | 8 | C-100 | 4 | C-100 | 6 |
| 56 | C-400 | 5 | C-140 | 7 | C-120 | 6 | C-100 | 5 |
| 68 | C-400 | 4 | C-140 | 5 | C-120 | 5 | C-120 | 8 |
| 82 | | | C-140 | 4 | C-BN | 5 | C-BN | 8 |
| 100 | | | C-200 | 8 | C-BN | 4 | C-BN | 7 |
| 120 | | | C-200 | 7 | C-140 | 8 | C-BN | 6 |
| 150 | | | C-200 | 5 | C-140 | 6 | C-BN | 5 |
| 180 | | | C-200 | 5 | C-140 | 5 | C-140 | 8 |
| 200 | | | C-400 | 6 | C-140 | 5 | C-140 | 7 |
| 220 | | | C-400 | 5 | C-200 | 9 | C-140 | 7 |
| 270 | | | C-400 | 4 | C-200 | 8 | C-140 | 6 |
| 330 | | | | | C-200 | 6 | C-140 | 5 |
| 390 | | | | | C-200 | 5 | C-200 | 9 |
| 470 | | | | | C-400 | 6 | C-200 | 7 |
| 560 | | | | | C-400 | 5 | C-200 | 6 |
| 680 | | | | | C-400 | 4 | C-200 | 5 |
| 820 | | | | | | | C-400 | 6 |
| 1000 | | | | | | | C-400 | 5 |
| 1200 | | | | | | | C-400 | 4 |

□ Class I Dielectrics ■ Class II Dielectrics



CR/CM Series — Row Capacitors

Row capacitors are used where arrays of capacitors (not necessarily identical) are needed, usually for decoupling/bypass of GaAs integrated circuits. Standard arrays can contain up to 10 capacitors from 0.04pF on up. Typical overall dimensions range from 20 x 10 mils on up. Parts can be fully customized to meet the requirements of your application to provide the shortest lead length possible.

DESCRIPTION

Row caps (CR) are also available with margins (CM) surrounding the edges to help prevent epoxy shorts and aid optical recognition systems.

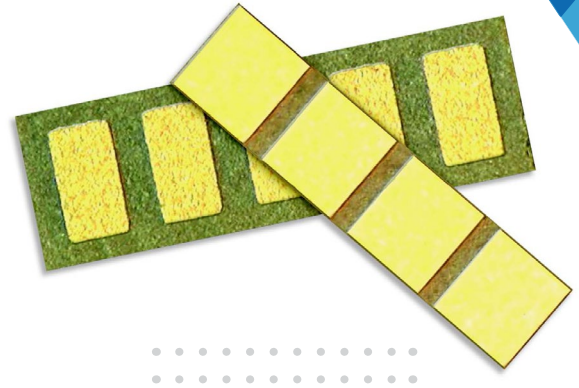

CR/CM STANDARD CAPACITANCE TOLERANCE CODES

Class I Dielectrics: C-20 thru C-NR

| Tolerance | Code |
|-----------|------|
| ± 20% | M |
| ± 15% | L |
| ± 10% | K |

Class II Dielectrics: C-80 thru C-400

| Tolerance | Code | Tolerance | Code |
|-----------------------|------|-----------|------|
| -10% thru +40% | Y | ± 20% | M |
| -20% thru +80% | Z | ± 15% | L |
| -0% thru +100% | V | ± 10% | K |
| Guaranteed Min. Value | GMV | | |

CR6 CHIP DIMENSIONS

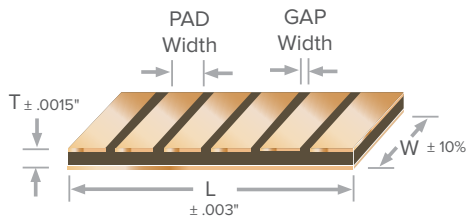

CR/CM ELECTRODE CONFIGURATION

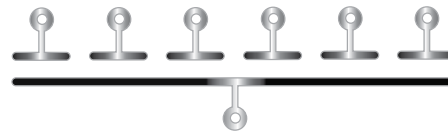

ORDERING INFORMATION — CR/CM SERIES — ROW CAPACITORS

| CR | 6 | 130 | 105 x 25 | x 4 | 5 | G | 101 | Z |
|-------------------------|-------------|---|---|--|------------|--------------------|---|--|
| Cap Style | No. of Caps | Dielectric Type | Length x Width (mils) | Thickness (mils) | Gap (mils) | Metallization | Capacitance (pF) | Capacitance Tolerance |
| CR = Row CM = Margin | - | See Class I and Class II tables (page 26) | See CR/CM Chip Dimensions (at right) | See CR/CM Chip Dimensions (at right) | | G = Gold Custom | First two digits represent significant figures and the last, the number of zeros to follow. When required, the letter "R" is used as a decimal point and the succeeding digits represent significant figures only. e.g.: 101 = 100pF, 1R6 = 1.6pF | See CR/CM Standard Capacitance Tolerance Codes (below) |

Note: Example shown: Complex Series CR, dielectric type C-BN, .105" x .025", gold, 100pF, +80 to -20% tolerance, 6 cap. chip

Please contact factory to request free samples.

CR/CM Series — Row Capacitors

CR/CM SELECTION CHART

Note: Selection Chart is for guidance only. The square area and capacitance parameters are for a single pad. All Compex parts are built to specific customer requirements.

Capacitor Size in Mils (mm)

| Cap. (pF) | 10x10 (.254x.254) | | 12x12 (.305x.305) | | 15x15 (.381x.381) | | 20x20 (.508x.508) | | 25x25 (.635x.635) | | 30x30 (.762x.762) | | 35x35 (.889x.889) | | 40x40 (1.016x1.016) | | 50x50 (1.27x1.27) | | | | | |
|--------------|-------------------|--------|-------------------|--------|-------------------|--------|-------------------|--------|-------------------|--------|-------------------|--------|-------------------|--------|---------------------|--------|-------------------|--------|--|--|--|--|
| | Diel. | Thick. | Diel. | Thick. | Diel. | Thick. | Diel. | Thick. | Diel. | Thick. | Diel. | Thick. | Diel. | Thick. | Diel. | Thick. | Diel. | Thick. | | | | |
| 0.04 | C-30 | 5 | C-30 | 6 | C-30 | 10 | | | | | | | | | Class I Dielectrics | | | | | | | |
| 0.06 | C-30 | 4 | C-30 | 5 | C-30 | 8 | C-20 | 5 | C-20 | 10 | | | | | | | | | | | | |
| 0.08 | C-50 | 10 | C-30 | 4 | C-30 | 6 | C-30 | 10 | C-20 | 7 | C-20 | 9 | | | | | | | | | | |
| 0.1 | C-50 | 8 | C-50 | 11 | C-30 | 5 | C-30 | 9 | C-20 | 5 | C-20 | 7 | C-20 | 10 | | | | | | | | |
| 0.2 | C-50 | 5 | C-50 | 7 | C-50 | 10 | C-30 | 4 | C-30 | 7 | C-30 | 10 | C-20 | 5 | C-20 | 7 | C-20 | 10 | | | | |
| 0.3 | C-58 | 6 | C-50 | 4 | C-50 | 6 | C-50 | 11 | C-30 | 4 | C-30 | 7 | C-30 | 9 | C-20 | 5 | C-20 | 7 | | | | |
| 0.4 | C-58 | 5 | C-58 | 7 | C-50 | 5 | C-50 | 9 | C-50 | 15 | C-30 | 5 | C-30 | 7 | C-30 | 9 | C-20 | 5 | | | | |
| 0.5 | C-58 | 4 | C-58 | 5 | C-50 | 4 | C-50 | 7 | C-50 | 11 | C-30 | 5 | C-30 | 5 | C-30 | 7 | C-20 | 4 | | | | |
| 0.6 | C-NR | 6 | C-58 | 5 | C-58 | 7 | C-50 | 6 | C-50 | 10 | C-50 | 15 | C-30 | 4 | C-30 | 6 | C-30 | 9 | | | | |
| 0.8 | C-80 | 8 | C-NR | 6 | C-58 | 5 | C-50 | 5 | C-50 | 7 | C-50 | 10 | C-50 | 15 | C-30 | 4 | C-30 | 7 | | | | |
| 1 | C-80 | 7 | C-NR | 5 | C-58 | 4 | C-58 | 7 | C-50 | 6 | C-50 | 8 | C-50 | 10 | C-30 | 4 | C-30 | 5 | | | | |
| 1.2 | C-80 | 6 | C-NR | 4 | C-58 | 4 | C-58 | 6 | C-50 | 5 | C-50 | 7 | C-50 | 9 | C-30 | 3 | C-30 | 5 | | | | |
| 1.5 | C-80 | 5 | C-80 | 7 | C-NR | 5 | C-58 | 5 | C-50 | 4 | C-50 | 6 | C-50 | 7 | C-50 | 10 | C-30 | 4 | | | | |
| 1.8 | C-80 | 4 | C-80 | 5 | C-NR | 4 | C-58 | 4 | C-58 | 6 | C-50 | 5 | C-50 | 6 | C-50 | 8 | C-50 | 11 | | | | |
| 2 | C-80 | 4 | C-80 | 5 | C-NR | 4 | C-NR | 7 | C-58 | 6 | C-50 | 4 | C-50 | 5 | C-50 | 7 | C-50 | 11 | | | | |
| 2.2 | C-BD/ BE | 4 | C-80 | 5 | C-NR | 4 | C-NR | 6 | C-58 | 5 | C-58 | 7 | C-50 | 5 | C-50 | 7 | C-50 | 10 | | | | |
| 2.7 | C-BD/ BE | 8 | C-80 | 4 | C-80 | 6 | C-NR | 5 | C-58 | 4 | C-58 | 6 | C-50 | 4 | C-50 | 5 | C-50 | 8 | | | | |
| 3.3 | C-BD/ BE | 7 | C-BD/ BE | 10 | C-80 | 5 | C-NR | 4 | C-NR | 6 | C-58 | 5 | C-58 | 7 | C-50 | 4 | C-50 | 7 | | | | |
| 3.9 | C-BD/ BE | 6 | C-BD/ BE | 9 | C-80 | 4 | C-80 | 7 | C-NR | 5 | C-58 | 4 | C-58 | 6 | C-58 | 8 | C-50 | 6 | | | | |
| 4.7 | C-BD/ BE | 5 | C-BD/ BE | 7 | C-BD/ BE | 11 | C-80 | 6 | C-NR | 4 | C-NR | 6 | C-58 | 5 | C-58 | 6 | C-50 | 5 | | | | |
| 5.6 | C-BD/ BE | 4 | C-BD/ BE | 6 | C-BD/ BE | 10 | C-80 | 5 | C-80 | 7 | C-NR | 5 | C-58 | 4 | C-58 | 5 | C-50 | 4 | | | | |
| 6.8 | C-BD/ BE | 4 | C-BD/ BE | 5 | C-BD/ BE | 8 | C-80 | 4 | C-80 | 6 | C-NR | 5 | C-NR | 6 | C-58 | 4 | C-58 | 7 | | | | |
| 8.2 | C-100 | 6 | C-BD/ BE | 4 | C-BD/ BE | 7 | C-80 | 4 | C-80 | 5 | C-NR | 4 | C-NR | 5 | C-NR | 7 | C-NR | 10 | | | | |
| 10 | C-100 | 5 | C-BD/ BE | 4 | C-BD/ BE | 5 | C-BD/ BE | 9 | C-80 | 4 | C-80 | 6 | C-NR | 4 | C-NR | 5 | C-NR | 8 | | | | |
| 12 | C-100 | 4 | C-100 | 6 | C-BD/ BE | 5 | C-BD/ BE | 8 | C-BD/ BE | 11 | C-80 | 5 | C-80 | 7 | C-NR | 4 | C-NR | 7 | | | | |
| 15 | C-120 | 6 | C-100 | 5 | C-BD/ BE | 4 | C-BD/ BE | 6 | C-BD/ BE | 10 | C-80 | 4 | C-80 | 6 | C-80 | 7 | C-NR | 6 | | | | |
| 18 | C-120 | 5 | C-100 | 4 | C-100 | 6 | C-BD/ BE | 5 | C-BD/ BE | 8 | C-BD/ BE | 11 | C-80 | 4 | C-80 | 6 | C-NR | 5 | | | | |
| 20 | C-120 | 5 | C-100 | 4 | C-100 | 6 | C-BD/ BE | 5 | C-BD/ BE | 8 | C-BD/ BE | 11 | C-80 | 4 | C-80 | 5 | C-NR | 4 | | | | |



CR/CM Series — Row Capacitors

CONTINUED

Capacitor Size in Mils (mm)

| Cap. (pF) | 10x10 (.254x.254) | | 12x12 (.305x.305) | | 15x15 (.381x.381) | | 20x20 (.508x.508) | | 25x25 (.635x.635) | | 30x30 (.762x.762) | | 35x35 (.889x.889) | | 40x40 (1.016x1.016) | | 50x50 (1.27x1.27) | | | | | |
|--------------|----------------------|--------|-------------------|--------|-------------------|--------|-------------------|--------|-------------------|--------|-------------------|--------|-------------------|--------|---------------------|--------|-------------------|--------|-------|-------|-------|---|
| | Diel. | Thick. | Diel. | Thick. | Diel. | Thick. | Diel. | Thick. | Diel. | Thick. | Diel. | Thick. | Diel. | Thick. | Diel. | Thick. | Diel. | Thick. | | | | |
| 22 | C-120 | 4 | C-120 | 6 | C-100 | 5 | C-BD/BE | 4 | C-BD/BE | 7 | C-BD/BE | 9 | C-80 | 4 | C-80 | 5 | C-NR | 4 | | | | |
| 27 | C-120 | 4 | C-120 | 5 | C-100 | 4 | C-BD/BE | 4 | C-BD/BE | 6 | C-BD/BE | 8 | C-80 | 3 | C-80 | 4 | C-80 | 6 | | | | |
| 33 | C-BN | 4 | C-120 | 4 | C-120 | 6 | C-100 | 6 | C-BD/BE | 5 | C-BD/BE | 6 | C-BD/BE | 11 | C-80 | 4 | C-80 | 5 | | | | |
| 39 | C-140 | 6 | C-120 | 4 | C-120 | 5 | C-100 | 5 | C-BD/BE | 4 | C-BD/BE | 5 | C-BD/BE | 7 | C-BD/BE | 10 | C-80 | 4 | | | | |
| 47 | C-140 | 5 | C-140 | 7 | C-120 | 5 | C-100 | 4 | C-100 | 6 | C-BD/BE | 5 | C-BD/BE | 6 | C-BD/BE | 8 | C-80 | 4 | | | | |
| 56 | C-140 | 4 | C-140 | 6 | C-BN | 5 | C-120 | 7 | C-100 | 5 | C-BD/BE | 4 | C-BD/BE | 5 | C-BD/BE | 7 | C-BD/BE | 10 | | | | |
| 68 | C-140 | 4 | C-140 | 5 | C-BN | 4 | C-120 | 6 | C-100 | 5 | C-100 | 6 | C-BD/BE | 4 | C-BD/BE | 6 | C-BD/BE | 9 | | | | |
| 82 | C-200 | 7 | C-140 | 4 | C-140 | 7 | C-BN | 6 | C-100 | 4 | C-100 | 5 | C-100 | 7 | C-100 | 10 | C-BD/BE | 7 | | | | |
| 100 | C-200 | 6 | C-200 | 8 | C-140 | 6 | C-BN | 5 | C-120 | 6 | C-100 | 5 | C-100 | 6 | C-100 | 8 | C-BD/BE | 6 | | | | |
| 120 | C-200 | 5 | C-200 | 7 | C-140 | 5 | C-140 | 8 | C-BN | 6 | C-100 | 4 | C-100 | 5 | C-100 | 7 | C-BD/BE | 5 | | | | |
| 150 | C-200 | 4 | C-200 | 5 | C-140 | 4 | C-140 | 7 | C-BN | 5 | C-BN | 7 | C-100 | 4 | C-100 | 5 | C-BD/BE | 4 | | | | |
| 180 | C-400 | 4 | C-200 | 5 | C-200 | 7 | C-140 | 6 | C-BN | 4 | C-BN | 6 | C-BN | 8 | C-120 | 8 | C-100 | 7 | | | | |
| 200 | C-400 | 4 | C-200 | 4 | C-200 | 6 | C-140 | 5 | C-140 | 8 | C-BN | 5 | C-BN | 7 | C-120 | 7 | C-100 | 6 | | | | |
| 220 | C-400 | 4 | C-400 | 5 | C-200 | 6 | C-140 | 4 | C-140 | 7 | C-BN | 5 | C-BN | 6 | C-120 | 6 | C-100 | 6 | | | | |
| 270 | | | C-400 | 4 | C-200 | 5 | C-200 | 8 | C-140 | 6 | C-BN | 4 | C-BN | 5 | C-120 | 5 | C-100 | 5 | | | | |
| 330 | | | | | C-200 | 4 | C-200 | 7 | C-140 | 5 | C-140 | 7 | C-BN | 4 | C-120 | 4 | C-120 | 7 | | | | |
| 390 | | | | | C-400 | 4 | C-200 | 6 | C-140 | 4 | C-140 | 6 | C-140 | 7 | C-140 | 10 | C-120 | 6 | | | | |
| 470 | | | | | C-400 | 4 | C-200 | 5 | C-200 | 7 | C-140 | 5 | C-140 | 6 | C-140 | 8 | C-120 | 5 | | | | |
| 560 | | | | | | | C-200 | 4 | C-200 | 6 | C-140 | 4 | C-140 | 5 | C-140 | 7 | C-120 | 4 | | | | |
| 680 | | | | | | | C-400 | 5 | C-200 | 5 | C-200 | 8 | C-140 | 5 | C-140 | 6 | C-BN | 4 | | | | |
| 820 | | | | | | | C-400 | 4 | C-400 | 6 | C-200 | 6 | C-140 | 4 | C-140 | 5 | C-140 | 7 | | | | |
| 1000 | | | | | | | | | C-400 | 5 | C-200 | 5 | C-200 | 7 | C-140 | 4 | C-140 | 6 | | | | |
| 1200 | | | | | | | | | C-400 | 4 | C-200 | 4 | C-200 | 6 | C-200 | 7 | C-140 | 5 | | | | |
| 1500 | Class II Dielectrics | | | | | | | | | | C-400 | 5 | C-200 | 5 | C-200 | 6 | C-140 | 4 | | | | |
| 1800 | | | | | | | | | | | | | | C-400 | 4 | C-400 | 6 | C-200 | 5 | C-200 | 8 | |
| 2200 | | | | | | | | | | | | | | | | C-400 | 5 | C-200 | 4 | C-200 | 6 | |
| 2700 | | | | | | | | | | | | | | | | | C-400 | 4 | C-400 | 5 | C-200 | 5 |
| 3300 | | | | | | | | | | | | | | | | | | | | | C-400 | 6 |



High-K Ceramic Substrates & Plates

High-K substrates are used for circuit miniaturization. DLI offers complete fabrication services.

CASE SIZES AND TOLERANCES

For custom sizes, please contact the sales office.

| Case Size (Inches) | Length (Inches) | Width (Inches) | Plates (H) ±(Inches) | Substrates (S) ±(Inches) |
|--------------------|-----------------|----------------|----------------------|--------------------------|
| 10 | 1.000 | 1.000 | Substrates Only | .002 |
| 15 | 1.000 | 1.500 | .050 | .002 |
| 20 | 2.000 | 2.000 | .050 | .002 |
| 25 | 2.500 | 2.500 | .050 | .002 |
| 30 | 3.000 | 3.000 | .050 | .002 |
| 40 | 4.000 | 4.000 | .050 | .002 |

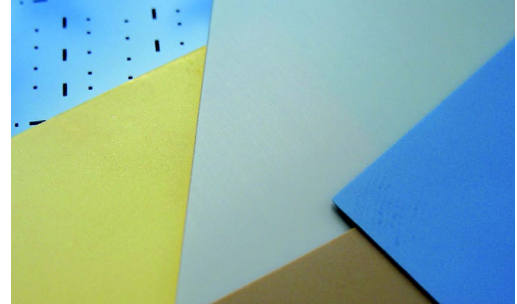

MATERIAL SPECIFICATIONS

| Material Code | Relative ϵ_R^* @ 5 GHz | TCC [†] Loss ppm/°C | Coefficient of Tangent* % Max | Thermal Expansion ppm/°K | Conductivity W/m-°K |
|---------------|---------------------------------|------------------------------|----------------------------------|--------------------------|---------------------|
| QZ | 3.82 (@ 1MHz) | Fused Quartz | 0.0015 (@ 1MHz) 0.033 (@ 24 GHz) | 0.55 | 1.28 |
| AG | 8.85 ± 0.35 (@ 1MHz) | Aluminum Nitride | 0.10 | 4.6 | 140 - 180 |
| PI | 9.9 ± 0.15 (@ 1MHz) | Alumina 99.6% | 0.01 | 6.5 - 7.5 | 27 |
| PG | 12.5 ± 0.5 | P22 ± 30 | 0.02 | 7.6 | - |
| AH | 20 ± 0.5 | P90 ± 20 | 0.02 | 9.6 | 1.56 |
| NA | 23 ± 1 | N30 ± 15 | 0.03 | 10.1 | 1.56 |
| CF | 25 ± 2 | 0 ± 15 | 0.15 | 9.0 | 1.56 |
| CD | 38 ± 1 | N20 ± 15 | 0.04 | 5.8 | 1.59 |
| CG | 67 ± 3 | 0 ± 30 | 0.10 | 9.0 | 1.59 |
| NR | 152 ± 5 | N1500 ± 500 | 0.06 | 10.0 | 2.72 |

*Unless otherwise specified, K dielectric measurement at approximately 5 GHz. †For the temperature range -55 to 125°C.



High-K Ceramic Substrates & Plates

CONTINUED

METALLIZATION

| Code | Description |
|------|---|
| X | No Metallization |
| M | 300 Angstroms TiW, 100 μ in. min. Au |
| N | 75 μ in. min. Nickel, 100 μ in. min. Au |
| P | 300 Angstroms TiW, 50 μ in. min. NiV, 100 μ in. min. Au |
| L | Top 50 Ohms/sq. TaN, 300 Angstroms TiW, 100 μ in. min Au |
| | Bottom Side 300 Angstroms TiW, 100 μ in. min. Au |
| E | Metallized and etched per customer drawing |
| T | 300 Angstroms min. TiW, 50 μ in. min. NiV, 300 μ in. min. Au-Sn |
| D | Special customer drawing required |

SURFACE FINISH

| Code | Roughness R | Material Process |
|------|-----------------------------------|------------------|
| X | >50μ in. | As-Fired |
| Y | 20μ in. | Machined |
| Z | <5μ in. | Polished |
| S | Special customer drawing required | |

SCREENING OPTIONS

| Test Code | Test/Inspection | Sample Size | Description |
|-----------|-------------------|-------------|---|
| X | Visual Mechanical | 100% | Verify that the required area is available and continuous (Broken corners allowable). |
| K | Visual Mechanical | 100% | Verify that the required area is available and continuous (Broken corners allowable). |
| | Kent Test | 10% of hot | K and Loss. |
| D | Customer Defined | - | Special customer drawing required |

ORDERING INFORMATION — THIN FILM — HIGH-K CERAMIC SUBSTRATES & PLATES

| S | 20 | CG | 250 | D | Z | N | X |
|----------------------------|-----------|--|--|---|--------------------------------------|------------------|--|
| Product | Case Size | Material | Thickness | Thickness Tolerance | Surface Finish | Metallization | Test Level |
| S = Substrate H = Plate | 10 | See material table above. | 100 = .010" 155 = .0155" 250 = .025" | D = ± .0005 E = ± .001 Thickness Tolerance Codes D = ± .0005 – Machined or Polished E = ± .001 – Standard | X Y Z S See table above. | See table above. | X K D See test level definitions on page 7. |
| | 15 | | Thickness Code. A three-digit code representing the thickness in mils. | | | | |
| | 20 | | Examples: | | | | |
| | 25 | | Code 100 = .010", | | | | |
| | 30 | | Code 155 = .0155", | | | | |
| | 40 | | Code 250 = .025" | | | | |
| | | Please consult with an applications engineer for thicknesses < .010" | | | | | |

SLC — Heatsinks, Standoffs & Submounts

HEATSINKS

- Heatsinks are fully metallized on all sides and are used to dissipate and absorb heat
- Heatsinks allow for high thermal conductivity and are electrically conductive (DC short)
- Typically used with LEDs or laser diodes

STANDOFFS

- A Standoff is much like a Heatsink; however it is typically metallized on only the top and bottom surfaces
- Each device is custom tailored to the customer's specifications and is typically used with LEDs or Photo Diodes (works as a photo detector, light is allowed in through fibers)

SUBMOUNTS

- Submounts are ceramic LED package bases that minimize thermal resistance between LED junctions and adjacent components
- By reducing junction temperatures, an LED will produce increased efficiency, brightness, color and reliability
- Each device is custom tailored to the customer's specifications

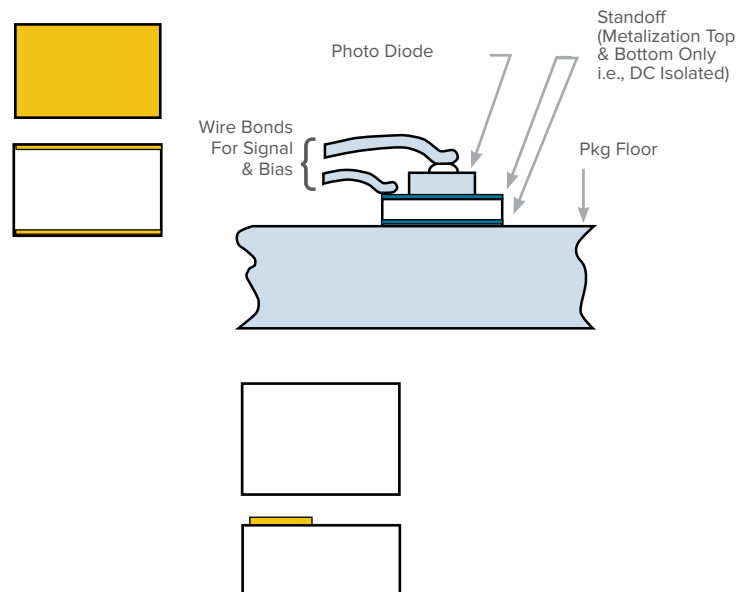
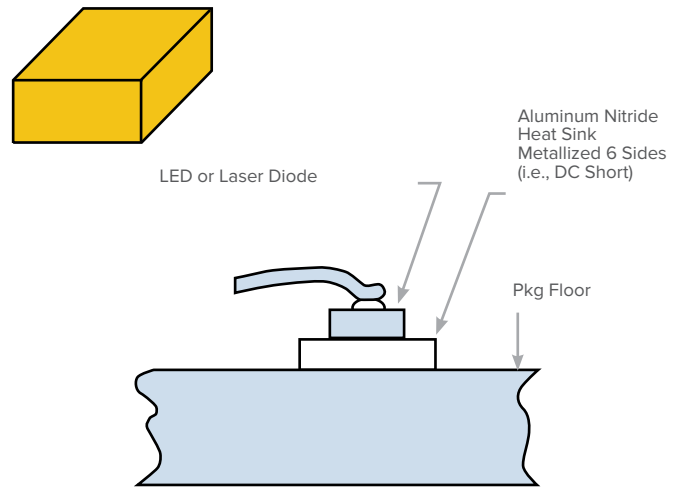

SLC — Heatsinks, Standoffs & Submounts

CONTINUED

MATERIAL SPECIFICATIONS

| Material Code | Relative ϵ_R^* @ 5 GHz | TCC [†] Loss ppm/°C | Coefficient of Tangent* % Max | Thermal Expansion ppm/°K | Conductivity W/m-°K |
|---------------|---------------------------------|------------------------------|-------------------------------|--------------------------|---------------------|
| AG | 8.85 ± 0.35 (@ 1MHz) | Aluminum Nitride | 0.10 | 4.6 | 140 - 180 |
| PI | 9.9 ± 0.15 (@ 1MHz) | Alumina 99.6% | 0.01 | 6.5 - 7.5 | 27 |

*Unless otherwise specified, K dielectric measurement at approximately 5 GHz. †For the temperature range -55 to 125°C. **Material only provided metalized.

SURFACE FINISH

| Code | Roughness R | Material Process |
|------|-----------------------------------|------------------|
| X | >50 μ in. | As-Fired |
| Y | 20 μ in. | Machined |
| Z | <5 μ in. | Polished |
| S | Special customer drawing required | |

METALLIZATION

| Code | Description |
|------|---|
| M | 300 Angstroms TiW, 100 μ in. min. Au |
| P | 75 μ in. min. Nickel, 100 μ in. min. Au |
| E | Metallized and etched per customer drawing |
| T | 300 Angstroms min. TiW, 50 μ in. min. NiV, 300 μ in. min. Au-Sn |
| D | Special customer drawing required |



SBT Series — Submounts

Submount materials include quartz, alumina, aluminum nitride, kovar and beryllium oxide.

Applications include heat sinks, standoffs, height matching, bonding pads and jumpers.

Custom sizes, patterns and shapes are available to your design specifications in thicknesses from 3 to 100 mils and beyond.



SUBMOUNT MATERIAL PROPERTIES CHART

| | Quartz | Alumina | AlN | Kovar | BeO | Si |
|---|--------|---------|------|-------|------|--------------------------|
| Material Code | C-20 | C-30/35 | C-28 | KVR | C-25 | C-22 |
| Coefficient of Thermal Expansion (ppm/°C) | 6 | 6.7 | 4.6 | 5.86 | 7.5 | 0.56 |
| Thermal Conductivity (W/m-k) | 1.6 | 26 | 170 | 17.3 | 270 | 1.38 (SiO ₂) |

ORDERING INFORMATION — SBT SERIES — SUBMOUNTS

| SBT | 28 | 20 x 20 | x 6 | G | S | 5 |
|---|--|-----------------------|------------------|--------------------------------|-------------|---|
| Cap Style | Material | Length x Width (mils) | Thickness (mils) | Metallization | Cut to Size | Thickness Tolerance |
| SBT = Edge-to-edge plated or bare CSX = Custom patterned | See Submount Material Properties Chart above | - | 3 to +100 mils | G = Gold B = Bare Custom | - | (only utilized if <.001"; figure represents tenths of a mil) |

Note: Standard dimensional tolerance is .001" for length, width, and thickness. Tighter Thickness tolerances down to .0002" are available.

Example: Complex Series SBT, dielectric type C-28, .020" x .020" x .006", gold, cut to size, .0005" thickness tolerance

[Kits available for design development](#)



MST Series — Mounting Shorts

Alumina mounting shorts (or Aluminum Nitride for improved thermal properties), with metallization on the top, bottom and two of four sides, allow placement of a wirebond anywhere in the circuit, replacing the need for gold terminations on the substrate. They also can be used to raise the ground plane, reducing lead length for reduced inductance for high-speed/frequency applications, or to dissipate heat from under an IC or laser chip.

DESCRIPTION

- Instant bonding pads
- Fully conductive
- Height matching
- Replaces moly-tabs
- Any size available, as small as .00003" x .0003"

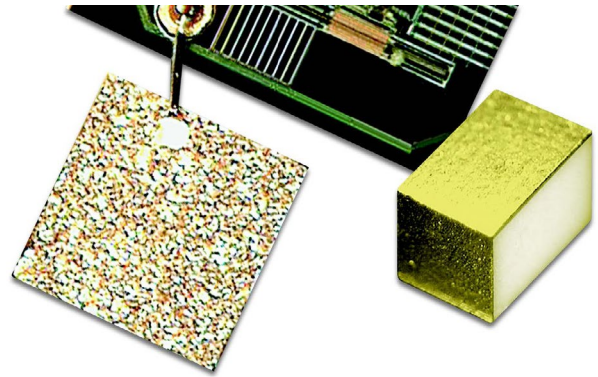

MST CHIP DIMENSIONS

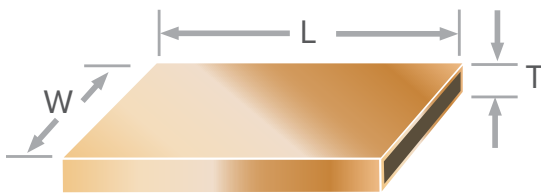

Dimensional Tolerance: Standard is .001" for length, width and thickness. Tighter tolerances down to .0003" are available for thickness .0005" and greater.

For <.0005", consult factory for available tolerances.

WIREBOND

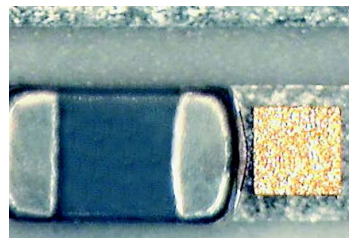

RAISED PLANE

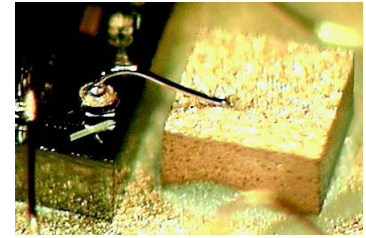

Our ceramic mounting shorts are excellent replacements for kovar and moly-tabs. These ceramic shorts have a much sharper edge and are flat stable bases for mounting semiconductors.

ORDERING INFORMATION — MST SERIES — MOUNTING SHORTS

| MST | 30 | 25 | x 20 | x 6 | G | S | 5 |
|-----------|----------|---------------|----------------------------------|-------------------------|--------------------|-------------|--|
| Cap Style | Material | Length (mils) | Width (unmetallized side) (mils) | Thickness (mils) | Metallization | Cut to Size | Thickness Tolerance |
| - | - | - | - | 3 to +100 mils G = Gold | G = Gold Custom | - | (only utilized if <.001"; figure represents tenths of a mil) |

Example Shown: Complex Series MST, dielectric type C-30, .025" x .020" x .006", gold, cut to size, .0005" thickness tolerance

[Kits available for design development](#)



Milli-Cap[®] — Ideal SMT Capacitor

FEATURES

- 0201, 0402 and 0602 Footprints
- Very Low Series Inductance
- Matches Typical 50Ω Line Widths
- Single-Piece Construction
- Low Loss High Q parts
- Ultra High Series Resonance
- Behaves Like an Ideal Capacitor
- Orientation Insensitive

FUNCTIONAL APPLICATIONS

- Test Equipment, Photonics, SONET, TOSA/ROSA, High-Speed Data
- Broadband Microwave/Millimeter Wave
- Transimpedance Amplifiers



SPECIFICATIONS — MILLI-CAP[®]

Electrical

| | |
|--|----------------------------------|
| Temperature Coefficient of Capacitance | Electrical Characteristics Table |
| Milli-Cap [®] Metallization | 7.5μ" Au over 50μ" Ni |
| Capacitance Range | 0.5pF to 82pF |
| Maximum Assembly Process Temperature | 250°C |

P21

Insertion Loss

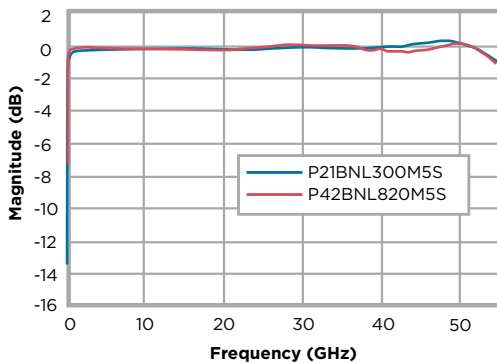

P62

Insertion Loss

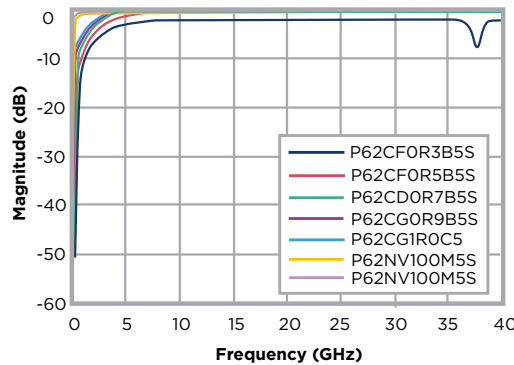

P42

Insertion Loss

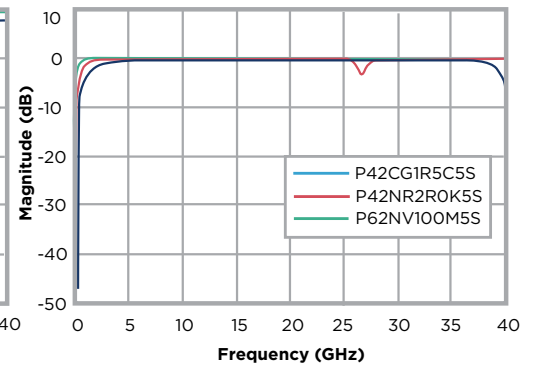

Milli-Cap® — Ideal SMT Capacitor

ELECTRICAL CHARACTERISTICS — MILLI-CAP®

| Part Number | Value (pF) | Voltage Rating | TCC | Dissipation Factor (Max) | Insulation Resistance (Min) | Frequency Range |
|--------------|------------|----------------|--------------------|--------------------------|-----------------------------|-----------------|
| P21BNL300M5S | 30 | 50 | ± 15% | 3.5% | 10 ⁶ MΩ | 20MHz – 50GHz |
| P42BNL820M5S | 82 | 50 | ± 15% | 3.5% | 10 ⁶ MΩ | 20MHz – 50GHz |
| P42NR2R0K5S | 2 | 50 | N1500 ± 500ppm/°C | 0.25% | 10 ⁶ MΩ | 4GHz – 20GHz |
| P42CG1R5C5S | 1.5 | 50 | 0 ± 30ppm/°C | 0.7% | 10 ⁶ MΩ | 8GHz – 32GHz |
| P62BNL820M5S | 82 | 50 | ± 15% | 3.5% | 10 ⁶ MΩ | 20MHz – 50GHz |
| P62NV100M5S | 10 | 50 | N4700 ± 1000ppm/°C | 1.2% | 10 ⁶ MΩ | 4GHz – 20GHz |
| P62CG1R0C5S | 1 | 50 | 0 ± 30ppm/°C | 0.7% | 10 ⁶ MΩ | 18GHz – 40GHz |
| P62CD0R7B5S | 0.7 | 50 | N20 ± 15ppm/°C | 0.15% | 10 ⁶ MΩ | 20GHz – 40GHz |
| P62CF0R5B5S | 0.5 | 50 | 0 ± 15 ppm/°C | 0.6% | 10 ⁶ MΩ | 28GHz – 40GHz |

DIMENSIONAL SPECIFICATIONS — MILLI-CAP®

| Case Size | Length | Milli-Cap® Width | Thickness |
|------------|-----------------|---------------------|-----------------|
| P21 (0201) | 0.020" ± 0.004" | 0.012" ± 0.002" | 0.010" ± 0.002 |
| P42 (0402) | 0.038" ± 0.004" | 0.020" ± 0.002" | 0.020" ± 0.002" |
| P62 (0602) | 0.058" ± 0.004" | 0.020" ± 0.002" | 0.020" ± 0.002" |

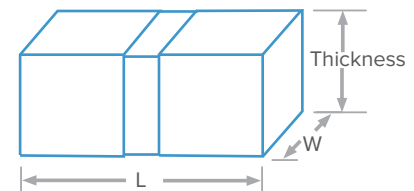

ATTACHMENT METHODS — MILLI-CAP®

Recommended attachment to soft or hard substrate using Conductive Epoxy

1. Place a single drop of conductive epoxy onto each microstrip as illustrated; the edge of the epoxy shall be at least .003"-.004" back from the edge of the trace to prevent filling the gap with epoxy.
2. Centering the termination gap of the capacitor within the gap in the microstrip, press with careful, even pressure onto the microstrip ensuring the terminations make good contact with the epoxy drops.
3. Cure according to the epoxy manufacturer's preferred schedule, typically 125°C to 150°C max.
4. After curing, inspect joint for epoxy shorts across the termination and microstrip gaps that would cause a short across the cap. Isopropanol and Methanol are both safe to use to pre-clean Milli-Caps®. Isopropanol and Methanol are not to be used after mounting with conductive epoxy as they act as a solvent.

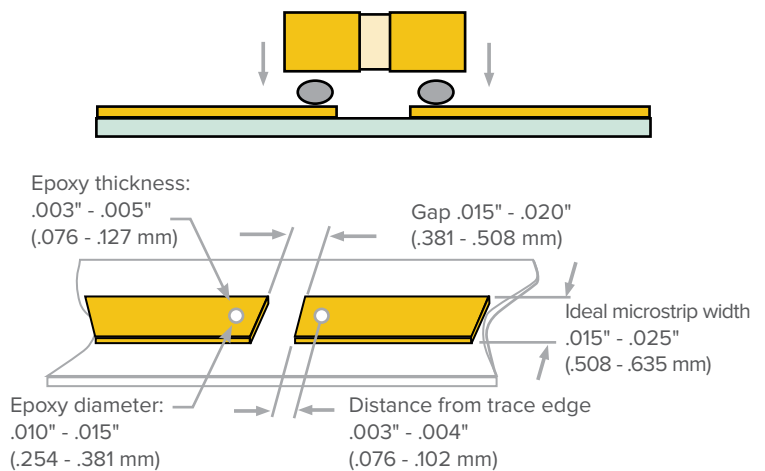

Recommended attachment to soft or hard substrate using Solder

1. Place a single drop of solder paste onto each micro strip as illustrated; the edge of the solder shall be at least .001"-.002" back from the edge of the trace to prevent filling the gap with solder.
2. Centering the termination gap of the capacitor within the gap in the microstrip, press with careful, even pressure onto the microstrip ensuring the terminations make good contact with the drops of solder paste.

3. Reflow according to the solder manufacturer's preferred profile, ensuring the reflow temperature does not exceed 250°C.
 4. After the reflow step is completed, inspect joint for voids or excess flux and non-reflowed solder balls that can degrade performance or cause shorts across the gaps. Proper cleaning after the reflow process is crucial to avoiding performance degradation and discovering poor solder joints.
- Isopropanol and Methanol are both safe to use with soldered Milli-Caps®.

Opti-Cap® — Ultra Broadband DC Blocking

FEATURES

- X7R temperature and voltage stability
- Resonance free DC blocking to >40GHz
- SMT by solder or epoxy bonding
- Low frequency stability over temperature
- Very low series inductance
- 0201, 0402 and 0602 footprints

FUNCTIONAL APPLICATIONS

- Test Equipment, Photonics, SONET, TOSA/ROSA, High-Speed Data
- Broadband Microwave/Millimeter Wave
- Transimpedance Amplifiers

BENEFITS

- Eliminates wire bonding
- Coplanar waveguide
- Low insertion loss



SPECIFICATIONS — OPTI-CAP®

| Electrical | |
|--|---|
| Temperature Coefficient of Capacitance | X5R: -55°C to +85°C (TCC ± 15%) X7R: -55°C to +125°C (TCC ± 15%) |
| Capacitance Range | 1.5nF to 220nF |
| Maximum Assembly Process Temperature | 250°C |

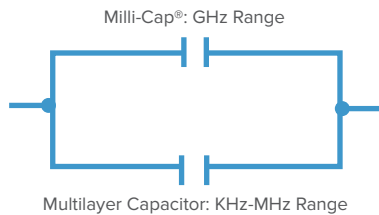

INSERTION LOSS

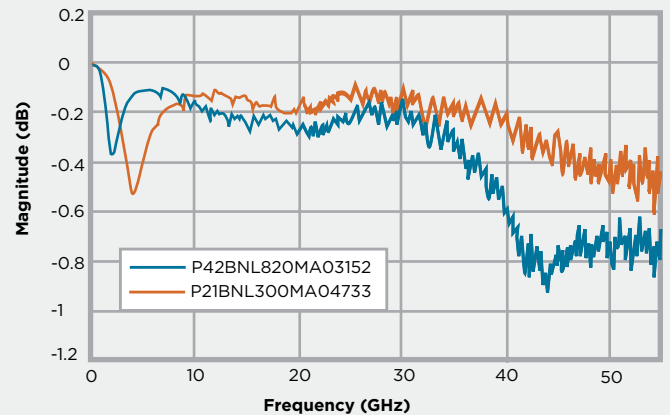

ELECTRICAL CHARACTERISTICS — OPTI-CAP®

| Part Number | Capacitance | | Voltage Rating | TCC | DF (MAX) | IR (MIN) | Frequency Range |
|------------------|-------------|------------|----------------|-----|----------|---------------------|-----------------|
| | MLC | Milli-Cap® | | | | | |
| P21BNL300MA04733 | 100nF | 30pF | 10V | X5R | 3.5% | >10 ² MΩ | 16KHz - >40GHz |
| P21BNL300MA04282 | 22nF | 30pF | | | | | |
| P21BNL300MA03976 | 10nF | 30pF | | | | | |
| P21BNL300MA04678 | 1.5nF | 30pF | 25V | X7R | | | |
| P42BNL820MA03152 | 220nF | 82pF | 10V | X5R | | | |
| P42BNL820MA04679 | 22nF | 82pF | 50V | X7R | | | |
| P62BNL820MA02636 | 100nF | 82pF | 25V | X7R | | | |



Opti-Cap[®] — Ultra Broadband DC Blocking

DIMENSIONAL SPECIFICATIONS — OPTI-CAP[®]

| Case Size | Opti-Cap [®] | | | MLC | | |
|------------|-----------------------|-----------------|-----------------|-----------------|-----------------|-----------------|
| | Length | Width | Thickness | Length | Width | Thickness |
| P21 (0201) | 0.020" ± 0.004" | 0.012" ± 0.002" | 0.010" ± 0.002" | 0.022" ± 0.002" | 0.010" ± 0.001" | 0.010" ± 0.002" |
| P42 (0402) | 0.038" ± 0.004" | 0.020" ± 0.002" | 0.020" ± 0.002" | 0.040" ± 0.002" | 0.020" ± 0.002" | 0.020" ± 0.002" |
| P62 (0602) | 0.058" ± 0.004" | 0.020" ± 0.002" | 0.020" ± 0.002" | 0.067" ± 0.004" | 0.031" ± 0.004" | 0.031" ± 0.005" |

ATTACHMENT METHODS — OPTI-CAP[®]

Recommended attachment to soft or hard substrate using Conductive Epoxy

1. Place a single drop of conductive epoxy onto each microstrip as illustrated; the edge of the epoxy shall be at least .003"-.004" back from the edge of the trace to prevent filling the gap with epoxy.
2. Centering the termination gap of the capacitor within the gap in the microstrip, press with careful, even pressure onto the microstrip ensuring the terminations make good contact with the epoxy drops.
3. Cure according to the epoxy manufacturer's preferred schedule, typically 125°C to 150°C max.
4. After curing, inspect joint for epoxy shorts across the termination and microstrip gaps that would cause a short across the cap.

Isopropanol and Methanol are both safe to use to pre-clean Opti-Caps[®], Isopropanol, and Methanol are not to be used after mounting with conductive epoxy as they act as a solvent!

Recommended attachment to soft or hard substrate using Solder

1. Place a single drop of solder paste onto each microstrip as illustrated; the edge of the solder shall be at least .001"-.002" back from the edge of the trace to prevent filling the gap with solder.
2. Centering the termination gap of the capacitor within the gap in the microstrip, press with careful, even pressure onto the microstrip ensuring the terminations make good contact with the drops of solder paste.

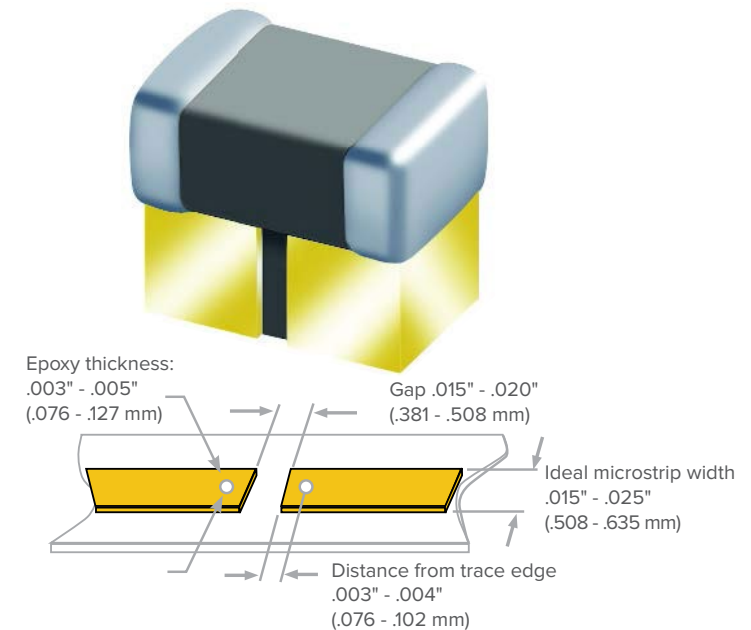

3. Reflow according to the solder manufacturer's preferred profile, ensuring the reflow temperature does not exceed 250°C.
4. After the reflow step is completed, inspect joint for voids or excess flux and non-reflowed solder balls that can degrade performance or cause shorts across the gaps. Proper cleaning after the reflow process is crucial to avoiding performance degradation and discovering poor solder joints.

Isopropanol and Methanol are both safe to use with soldered Opti-Caps[®].

PX Series — Broadband Blocking Device

FEATURES

- X7R temperature and voltage stability
- Low frequency stability
- Low insertion Loss
- Solder or epoxy attachment

FUNCTIONAL APPLICATIONS

- Broadband Microwave/Millimeter Wave
- Test Equipment
- ROSA/TOSA
- SONET



SPECIFICATIONS — PX SERIES

Electrical

| | |
|--|---|
| Temperature Coefficient of Capacitance | SLC: 120pF Guaranteed Minimum Value (GMV) MLC: 100nF ±10% |
| Voltage | 16WVDC |
| Dissipation Factor | 3.0% @ 1MHz |
| Insulation Resistance | >103 MΩ |
| Assembly Process Temperature | 250°C |

| Part Number | Metallization |
|---------------|-----------------------------------|
| PX42UX104KCZX | Sn (200μ") / Ni (150-250μ") |
| PX42UX104KCSX | Au (5-15μ") / Ni (150-250μ") |
| Packaging | (T) Tape & Reel - (W) Waffle Pack |

Mechanical

| | |
|----------------|-------------|
| Pressure force | >2.5N (min) |
|----------------|-------------|

TYPICAL INSERTION LOSS (S11)

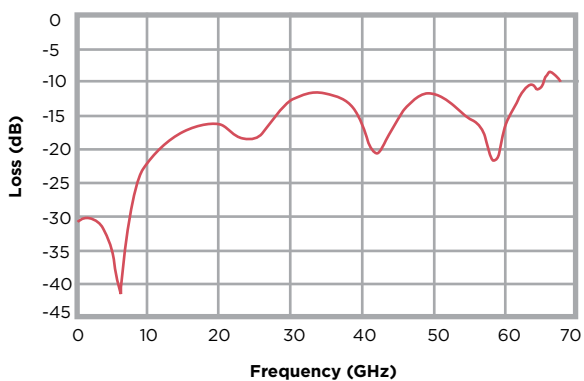

TYPICAL INSERTION LOSS (S21)

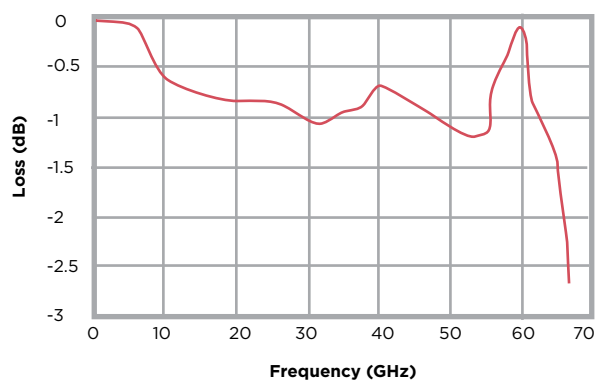

PX Series — Broadband Blocking Device

DIMENSIONS - PX SERIES BROADBAND BLOCKING DEVICE

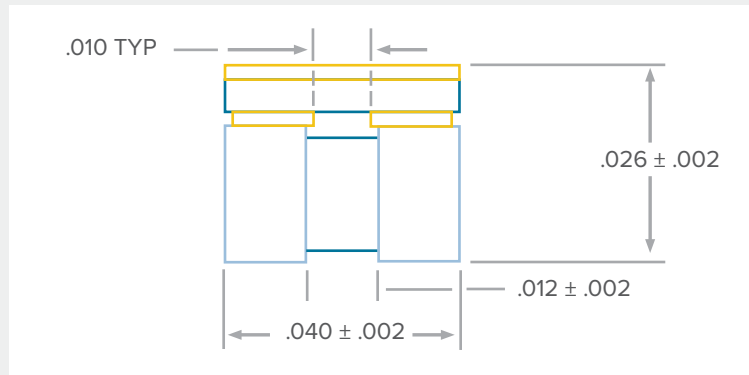

ATTACHMENT METHODS — PX SERIES — BROADBAND BLOCKING DEVICE

Recommended attachment to soft or hard substrate using Solder: Recommended Microstrip Layout:

1. Place a single drop of solder paste onto each microstrip as illustrated; the edge of the solder shall be at least .001"-.002" back from the edge of the trace to prevent filling the gap with solder.
2. Centering the termination gap of the capacitor within the gap in the microstrip, press with careful, even pressure onto the microstrip ensuring the terminations make good contact with the drops of solder paste.
3. Reflow according to the solder manufacturer's preferred profile, ensuring the reflow temperature does not exceed 260°C.
4. After the reflow step is completed, inspect joint for voids or excess flux and non-reflowed solder balls that can degrade performance or cause shorts across the gaps. Proper cleaning after the reflow process is crucial to avoiding performance degradation and discovering poor solder joints.

Isopropanol and Methanol are both safe to use with soldered units.

Mounting

The part is designed for surface mounting using conventional reflow soldering techniques. In accordance with normal recommendations for ceramic MLCCs, hand soldering should be avoided as soldering irons could cause thermal damage or disconnections within the device. If rework or manual placing is necessary, then the use of a hot air pencil is recommended. Preheating the board can assist with manual soldering. Pb free compatible.

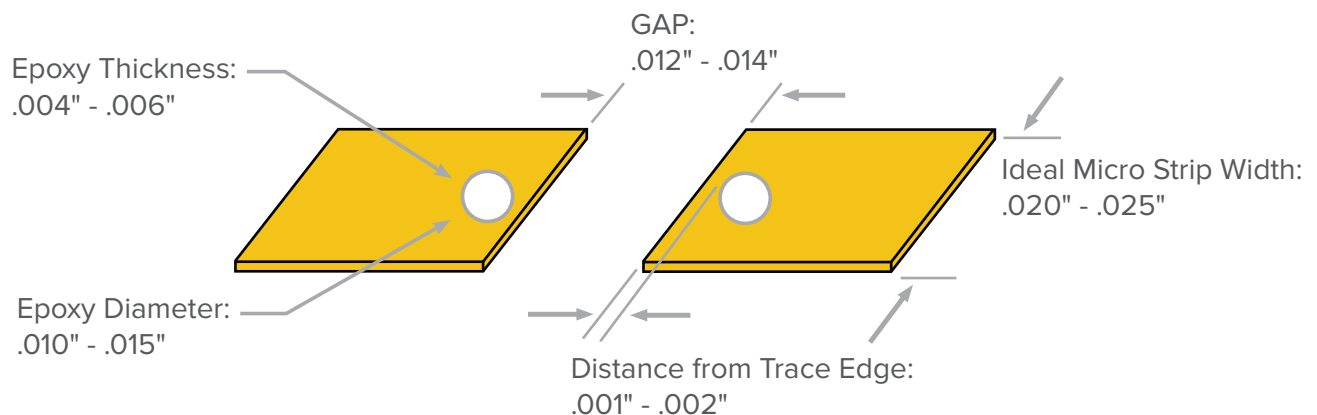

MLC — Broadband Blocks

DESCRIPTION

- Resonance free DC Blocking/Decoupling
- Less than 0.25 db loss @ 4 GHz (typical)
- Surface mountable

FUNCTIONAL APPLICATIONS

- Fiber Optic Links • High Isolation Decoupling • LANs, VCO Frequency Stabilization
- Diplexers • RF/Microwave Modules • Instruments • Test Equipments



MECHANICAL SPECIFICATIONS

| Product Code | Lengths (L) | Body Dimensions | | Band Dimensions | |
|--------------|------------------|------------------|---------------|-----------------|---------|
| | | Width (W) | Thickness (T) | Min | Max |
| C04BL | 0.040" ± 0.008" | 0.020" ± 0.006" | 0.028" Max | 0.003" | 0.019" |
| C06BL | 0.060" ± 0.012" | 0.031" ± 0.009" | 0.036" Max | 0.006" | 0.03" |
| C08BL | 0.081" ± 0.020" | 0.051" ± 0.013" | 0.061" Max | 0.012" | 0.0468" |
| C18BL | 0.1200" ± 0.925" | 0.1100" ± 0.010" | 0.100" Max | 0.008" | 0.045" |

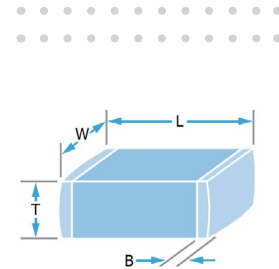

PART CHARACTERISTICS

| Part Number | Capacitance Guaranteed Min Value | Voltage Rating | Temperature Coefficient -55°C to 125°C | Maximum Dissipation Factor | Insulation Resistance (MΩ Minimum) | Aging Rate | Frequency Range | Termination |
|-------------------|----------------------------------|-------------------|--|----------------------------|------------------------------------|---------------------|-----------------|----------------|
| C04BL121X-5UN-X0T | 120pF @ 1KHz, 2Vrms | 50 Vdc | ± 15% | 3.0% @ 1KHz, 2Vrms | 10 ⁴ | <=1.5%/decade hours | 10MHz – 40GHz | "U" & "S" |
| C06BL851X-1UN-X0T | 850pF @ 1KHz, 2Vrms | 100 Vdc 50 Vdc | | | | | 2MHz – 30GHz | "U", "S" & "Z" |
| C08BL242X-5UN-X0T | 2400pF @ 1KHz, 2Vrms | 50 Vdc | | | | | 1MHz – 20GHz | "U", "S" & "Z" |
| C08BL102X-1UN-X0T | 1000pF @ 1KHz, 2Vrms | 100 Vdc | | | | | 1MHz – 20GHz " | "U", "S" & "Z" |
| C18BL103X-4UN-X0T | 10,000pF @ 1KHz, 2Vrms | 500 Vdc | | | | | 1MHz – 6GHz " | "U", "S" & "Z" |

PERFORMANCE

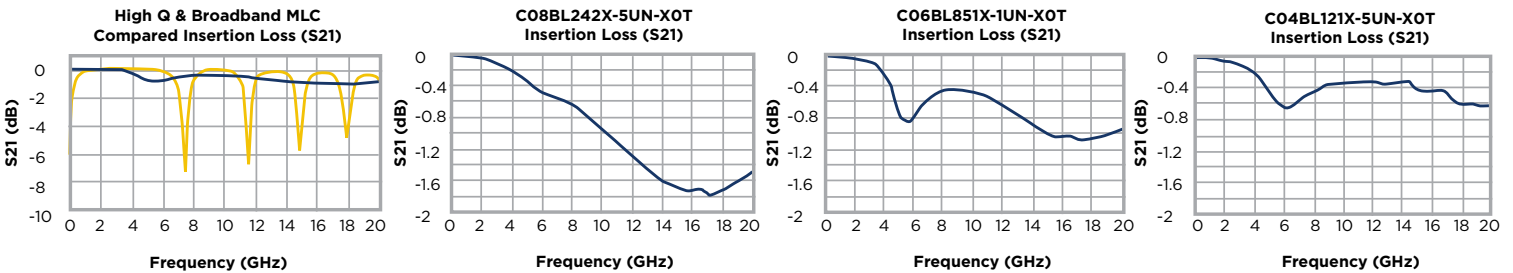

The information above represents typical device performance.

SLC — Gain Equalizers

SERIES OVERVIEW

The DLI brand of gain equalizers are designed to compensate for module gain slope. Excellent repeatable microwave performance is achieved by application of precision thin-film fabrication and high-permittivity ceramic materials. This unique design solution provides near ideal R-C frequency response that is far superior to "stacked R-C chip" assemblies.



DESIGN ADVANTAGES:

- Many designs smaller than 0402 case size
- Ease of integration
- Customization available

APPLICATIONS:

- Broadband Microwave modules: EW, ECM, ECCM
- Equalizer is utilized as a compensation circuit to correct for loss slope created by other circuit elements such as amplifiers

KEY CHARACTERISTICS:

- Superior microwave performance
- Reduced cost
- Flatten amplifier gain response
- Positive gain slope

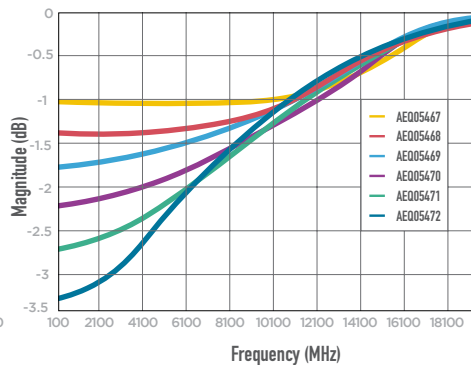
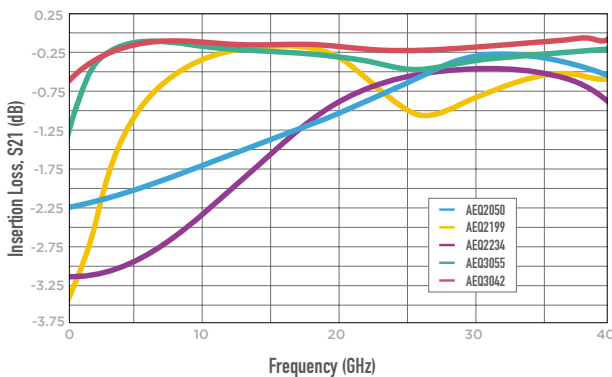

CERTIFICATION:



ORDERING INFORMATION:

| Epoxy | Solderable | Lp | Wp | G | Nominal Slope | Length | Width | Thickness |
|----------|------------|----------|----------|--------|---------------|--------|--------|-----------|
| AEQ2050 | AEQ05510 | 9 ± 1 | 14 ± 1 | 8 ± 1 | 2.25 dB | 30 ± 2 | 18 ± 2 | 5 ± 1 |
| AEQ2199 | AEQ05246 | 7 ± 1 | | 12 ± 1 | 3.5 dB | 28 ± 2 | 16 ± 2 | 7 ± 1 |
| AEQ2234 | AEQ06042 | 8 ± 1 | 12 ± 1 | 3 ± 1 | 3.25 dB | 32 ± 1 | | 20 ± 2 |
| AEQ3042 | AEQ3042 | 17.5 ± 1 | 17.5 ± 1 | | 0.6 dB | 40 ± 2 | 16 ± 1 | |
| AEQ3055 | AEQ3055 | 15.4 ± 1 | 18.4 ± 1 | 1.5 dB | | | | |
| AEQ05467 | AEQ05467 | 7 min | 14 ± 1 | 10 | 1.0 dB | 28 ± 1 | 16 ± 1 | 7 ± 1 |
| AEQ05468 | AEQ05468 | | | | 1.5 dB | | | |
| AEQ05469 | AEQ05469 | | | | 2.0 dB | | | |
| AEQ05470 | AEQ05470 | | | | 2.5 dB | | | |
| AEQ05471 | AEQ05471 | | | | 3.0 dB | | | |
| AEQ05472 | AEQ05472 | | | | 3.5 dB | | | |



SLC — Gain Equalizers

GAIN EQUALIZER KIT

Knowles understands your needs for higher performance filters in smaller, lighter packages. Our Gain Equalizers offer gain slope compensation in a single component.

Benefits include:

- Superior microwave performance
- Excellent repeatability
- Ease of assembly
- Custom designs
- Small size (0402 or smaller)
- Products up through 40GHz



| | AEQ02050 | AEQ02199 | AEQ02234 | AEQ03055 | AEQ03042 |
|-----------------|----------|----------|----------|----------|----------|
| Low Freq. Loss | 2.2dB | 3.0dB | 3.5dB | 1.6dB | 0.8dB |
| Min. Loss Freq. | 31.0GHz | 15.0GHz | 27.0GHz | 5.0GHz | 5.0GHz |
| Mounting Method | Epoxy | Epoxy | Epoxy | Solder | Solder |

EW GAIN EQUALIZER KIT

Knowles understands your needs for higher performance filters in smaller, lighter packages. Our Gain Equalizers offer gain slope compensation in a single component.

Benefits include:

- Superior microwave performance
- Excellent repeatability
- Ease of assembly
- Custom designs
- Small size (0402 or smaller)
- Products up through 40GHz



| | AEQ05467 | AEQ05468 | AEQ05469 | AEQ05470 | AEQ05471 | AEQ05472 |
|-----------------|--------------|--------------|--------------|--------------|--------------|--------------|
| Low Freq. Loss | 1.0dB | 1.35dB | 1.75dB | 2.25dB | 2.75dB | 3.25dB |
| Min. Loss Freq. | 18GHz | 18GHz | 18GHz | 18GHz | 18GHz | 18GHz |
| Mounting Method | Solder/Epoxy | Solder/Epoxy | Solder/Epoxy | Solder/Epoxy | Solder/Epoxy | Solder/Epoxy |



Custom Thin Film: Integrated R-C Networks

C-R-C DECOUPLING NETWORKS

(aka. RF Blocking Networks)

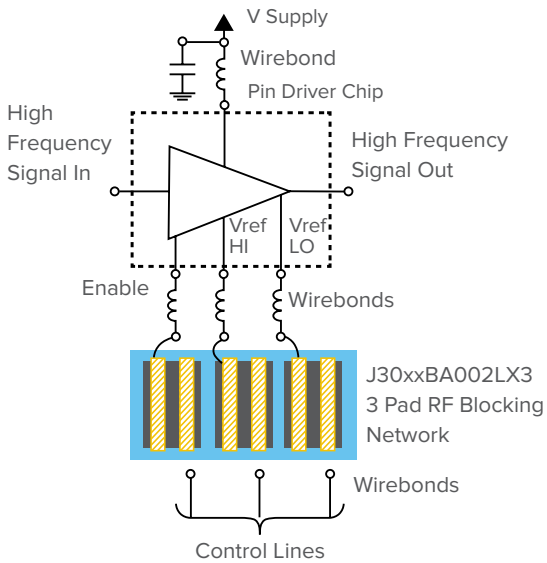

Segment Equivalent Schematic Representation

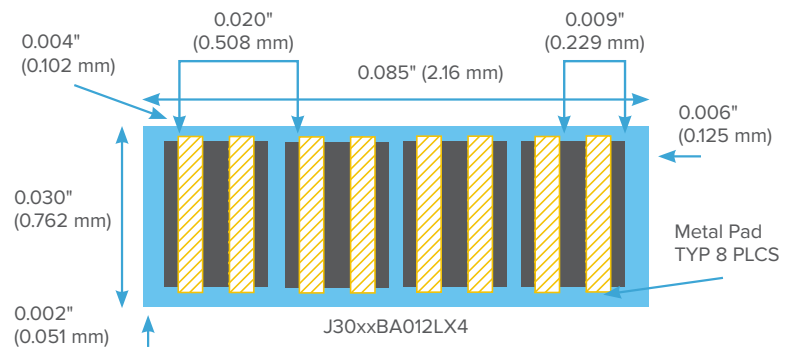
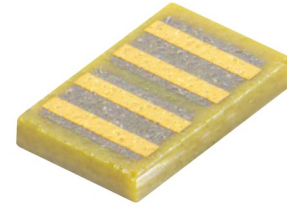
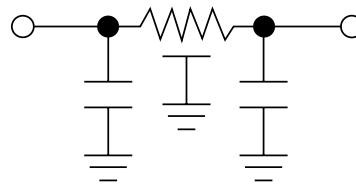

APPLICATIONS:

- Heatsinks and standoff
- Integrated passive components
- Custom resistor capacitor networks
- Large couplers, power combiners
- EMI filters
- High-frequency filters
- Microwave-integrated circuits (MIC)
- Bias decoupling and filtering
- Lumped element impedance matching network
- PA stabilization
- Impedance matching and power combining network

| Part Number | J30BLBA032LX1 | J30BLBA022LX2 | J30BLBA002LX3 | J30BLBA012LX4 | J30BJBA032LX1 | J30BJBA022LX2 | J30BJBA002LX3 | J30BJBA012LX4 |
|-------------------------------------|---|---------------|---------------|---------------|---------------|---------------|---------------|---------------|
| Number of RC Segments | 1 | 2 | 3 | 4 | 1 | 2 | 3 | 4 |
| Nominal Resistance (pad to pad) (Ω) | 10 | 10 | 10 | 10 | 10 | 10 | 10 | 10 |
| Capacitance (typical) (pF) | 30 | 30 | 30 | 30 | 45 | 45 | 45 | 45 |
| Maximum DF | 3.00% | 3.00% | 3.00% | 3.00% | 3.00% | 3.00% | 3.00% | 3.00% |
| TCC | X7R | X7R | X7R | X7R | X7R | X7R | X7R | X7R |
| Rated Voltage (Vdc) | 25 | 25 | 25 | 25 | 25 | 25 | 25 | 25 |
| Attachment Method | All are configured for Chip & Wire attachment | | | | | | | |
| Termination Finish | 100μinches Au, minimum | | | | | | | |
| Dimensions (inches) | | | | | | | | |
| L | 0.025 | 0.045 | 0.065 | 0.085 | 0.250 | 0.045 | 0.065 | 0.085 |
| W | 0.030 | 0.030 | 0.030 | 0.030 | 0.030 | 0.030 | 0.030 | 0.030 |
| Dimensions (mm) | | | | | | | | |
| L | 0.64 | 1.14 | 1.65 | 2.16 | 6.35 | 1.14 | 1.65 | 2.16 |
| W | 0.76 | 0.76 | 0.76 | 0.76 | 0.76 | 0.76 | 0.76 | 0.76 |

Custom Thin Film: Integrated R-C Networks

CONTINUED

BIASED FILTER NETWORK SERIES OVERVIEW

DLI bandpass filters are designed for high-performance microwave applications in a surface mountable package. Using temperature-stable, high-permittivity dielectrics and thin-film processing, these designs offer high selectivity without sacrificing in-band performance.

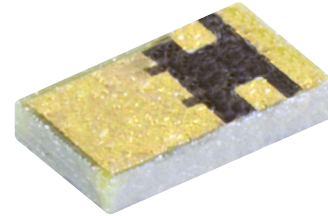

EQUIVALENT SCHEMATIC REPRESENTATION:

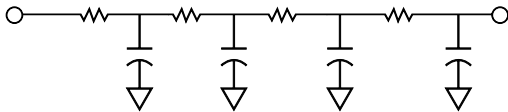

| Part Number | Cap Range | Resist | Width | Length | Thickness |
|-------------|-------------|-----------|-------------|-------------|-------------|
| B20BHSBN01 | 40 to 90pF | 100 ± 20% | .020 ± .001 | .034 ± .001 | .006 ± .001 |
| B20BLSBN01 | 40 to 90pF | 100 ± 20% | .020 ± .001 | .034 ± .001 | .006 ± .001 |
| B28BHBFN01 | 76 to 171pF | 600 ± 20% | .028 ± .001 | .053 ± .001 | .007 ± .001 |

SELF-BIASED NETWORK SERIES OVERVIEW

Knowles Precision Devices takes advantage of the high-permittivity ceramics offered by the DLI brand combined with thin-film resistors to provide a device that integrates source decoupling and user-selectable bias resistance.

The technique is commonly referred to as a self-biased GaAs FET amplifier – this enables the use of a single DC supply voltage. The gate is at DC ground potential and a negative V_{gs} is provided by the voltage drop across the wire bond selected resistors from source to ground – thus setting the desired drain bias current (I_{DS}).

The chip network is designed for epoxy attachment to a ground ridge, one on either side of an FET chip transistor. This provides symmetric, minimum reactance to ground source bypassing for optimum FET gain, by selectively wire bonding from resistor pads to ground. The pair of networks used for each FET provides a wide range of resistance combinations. The Self-Biased Networks, used as a pair replace two standard parallel plate capacitors and a separate set of bias resistors, reducing parts count, assembly and size.

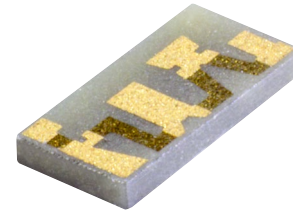

| Part Number | Cap Range | Resist | Width | Length | Thickness |
|-------------|--------------|-----------|-------------|-------------|-------------|
| B28BJBFN01 | 76 to 171pF | 600 ± 20% | .028 ± .001 | .053 ± .001 | .007 ± .001 |
| B28BTBFN01 | 112 to 168pF | 600 ± 20% | .028 ± .001 | .053 ± .001 | .007 ± .001 |



Our Other Products

- Air Capacitors
- Discoidal Capacitors
- EMI Filters
- Feedthrough EMI Filters
- Gain Equalizers
- Half-Turn Trimmers
- Hi-Cap Capacitors
- Hi-Rel Products
- Hi-Rel and Specialty Products
- Lead Capacitors
- Loaded Capacitors
- Opti-Cap® Capacitors
- Planar Arrays
- Pulse Capacitors
- Special Discrete Filters
- Special Filters
- Speciality Products
- Stacked Chips
- Trimmers
- Trimmer Capacitors
- Varistor Filters
- X8R Capacitors
- 250Vac Chips
- 500Vac X7R Chips

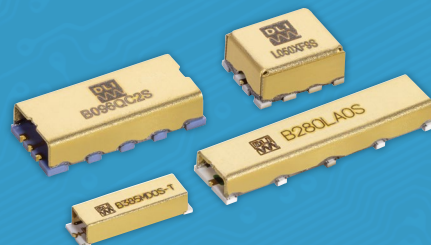



Asian Sales Office

O: +86 512 62588258

F: +86 512 62589258

KPD-Asia-sales@knowles.com

European Sales Office

O: +44 1603 723300

F: +44 1603 723301

KPD-Europe-sales@knowles.com

North American Sales Office

O: +1 661 295 5920

F: +1 661 295 5928

O: +1 315 655 8710

F: +1 315 655 0445

KPD-NA-sales@knowles.com

031821 R/5

Mouser Electronics

Authorized Distributor

Click to View Pricing, Inventory, Delivery & Lifecycle Information:

[Knowles:](#)

[D50NS300K1PX](#)