

FEATURES

- Very low offset voltage: 12 μV maximum over temperature
- Very low input offset voltage drift: 65 nV/ $^{\circ}\text{C}$ maximum
- High CMRR: 96 dB minimum
- Digitally programmable gain and output offset voltage
- Gain range from 28 to 1300
- Qualified for automotive applications
- Single-wire serial interface
- Stable with any capacitive load
- SOIC and LFCSP packages
- 2.7 V to 5.5 V operation

APPLICATIONS

- Automotive sensors
- Pressure and position sensors
- Precision current sensing
- Thermocouple amplifiers
- Industrial weigh scales
- Strain gages

GENERAL DESCRIPTION

The [AD8557](#) is a zero drift, sensor signal amplifier with digitally programmable gain and output offset. Designed to easily and accurately convert variable pressure sensor and strain bridge outputs to a well-defined output voltage range, the [AD8557](#) accurately amplifies many other differential or single-ended sensor outputs. The [AD8557](#) uses the Analog Devices, Inc., proprietary low noise auto-zero and DigiTrim[®] technologies to create an accurate and flexible signal processing solution in a compact footprint.

Gain is digitally programmable in a wide range from 28 to 1300 through a serial data interface. Gain adjustment can be fully simulated in circuit and then permanently programmed with reliable polyfuse technology. Output offset voltage is also digitally programmable and is ratiometric to the supply voltage.

In addition to extremely low input offset voltage and input offset voltage drift and very high dc and ac CMRR, the [AD8557](#)

FUNCTIONAL BLOCK DIAGRAM

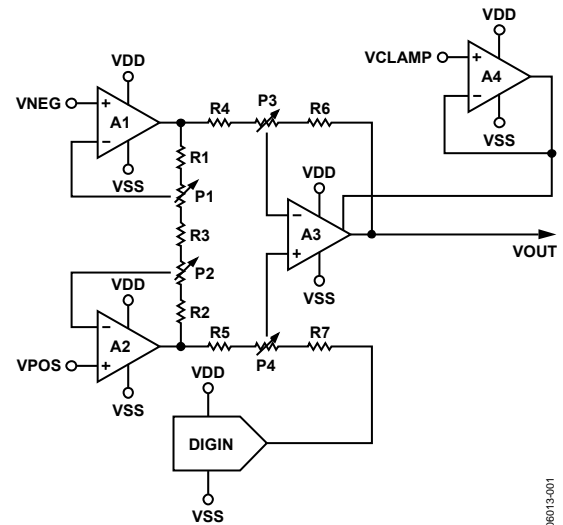

Figure 1.

also includes a pull-up current source at the input pins and a pull-down current source at the VCLAMP pin. Output clamping set via an external reference voltage allows the [AD8557](#) to drive lower voltage analog-to-digital converters (ADCs) safely and accurately.

When used in conjunction with an ADC referenced to the same supply, the system accuracy becomes immune to normal supply voltage variations. Output offset voltage can be adjusted with a resolution of better than 0.4% of the difference between VDD and VSS. A lockout trim after gain and offset adjustment further ensures field reliability.

The [AD8557](#) is fully specified from -40°C to $+125^{\circ}\text{C}$. Operating from single-supply voltages of 2.7 V to 5.5 V, the [AD8557](#) is offered in an 8-lead SOIC, and a 4 mm \times 4 mm, 16-lead LFCSP.

TABLE OF CONTENTS

| | | | |
|--|---|--|----|
| Features | 1 | Theory of Operation | 14 |
| Applications..... | 1 | Gain Values | 15 |
| Functional Block Diagram | 1 | Open Wire Fault Detection..... | 16 |
| General Description | 1 | Shorted Wire Fault Detection..... | 16 |
| Revision History | 2 | Floating VPOS, VNEG, or VCLAMP Fault Detection | 16 |
| Specifications..... | 3 | Device Programming..... | 16 |
| Absolute Maximum Ratings..... | 5 | Outline Dimensions | 21 |
| Thermal Resistance | 5 | Ordering Guide | 22 |
| ESD Caution..... | 5 | Automotive Products..... | 22 |
| Pin Configurations and Function Descriptions | 6 | | |
| Typical Performance Characteristics | 7 | | |

REVISION HISTORY

5/16—Rev. C to Rev. D

| | |
|--------------------------------------|------------|
| Changed CP-16-10 to CP-16-20 | Throughout |
| Changes to Figure 3 and Table 5..... | 6 |
| Updated Outline Dimensions | 21 |
| Changes to Ordering Guide | 22 |

6/11—Rev. B to Rev. C

| | |
|--|----|
| Added EPAD Note to Figure 3 and Table 5..... | 6 |
| Changes to Open Wire Fault Detection Section and Table 8 ... | 16 |

7/10—Rev. A to Rev. B

| | |
|---|----|
| Changes to Features Section and Figure 1..... | 1 |
| Changes to Figure 45..... | 14 |
| Changes to Simulation Mode Section and Programming Mode Section..... | 18 |
| Changes to Ordering Guide | 22 |
| Added Automotive Products Section | 22 |

1/08—Rev. 0 to Rev. A

| | |
|--|----|
| Changes to Theory of Operation Section..... | 14 |
| Changes to Determining Optimal Gain and Offset Codes Section..... | 20 |

5/07—Revision 0: Initial Version

SPECIFICATIONS

VDD = 5.0 V, VSS = 0.0 V, V_{CM} = 2.5 V, V_{OUT} = 2.5 V, gain = 28, T_A = -40°C to +125°C, unless otherwise specified.

Table 1.

| Parameter | Symbol | Test Conditions/Comments | Min | Typ | Max | Unit |
|---|--------------------------------|---|-----------|------|-----------|-----------|
| INPUT STAGE | | | | | | |
| Input Offset Voltage | V _{OS} | | | 2 | 12 | μV |
| Input Offset Voltage Drift | T _C V _{OS} | | | 27 | 65 | nV/°C |
| Input Bias Current | I _B | | 10 | 18 | 25 | nA |
| Input Offset Current | I _{OS} | | | 1 | 4 | nA |
| Input Voltage Range | | | 0.6 | | 3.8 | V |
| Common-Mode Rejection Ratio | CMRR | V _{CM} = 0.9 V to 3.6 V, A _V = 28 | 75 | 85 | | dB |
| | | V _{CM} = 0.9 V to 3.6 V, A _V = 1300 | 96 | 112 | | dB |
| Linearity | | V _{OUT} = 0.2 V to 3.4 V | | 20 | | ppm |
| | | V _{OUT} = 0.2 V to 4.8 V | | 1000 | | ppm |
| Differential Gain Accuracy | | Second stage gain = 10 to 70 | | | 1.6 | % |
| Differential Gain Accuracy | | Second stage gain = 100 to 250 | | | 2.5 | % |
| Differential Gain Temperature Coefficient | | Second stage gain = 10 to 250 | | 15 | 40 | ppm/°C |
| DAC | | | | | | |
| Accuracy | | Offset codes = 8 to 248 | | 0.7 | 0.8 | % |
| Ratiometricity | | Offset codes = 8 to 248 | | 50 | | ppm |
| Output Offset | | Offset codes = 8 to 248 | | 5 | 35 | mV |
| Temperature Coefficient | | | | 20 | 80 | ppm FS/°C |
| VCLAMP | | | | | | |
| Clamp Input Bias Current | ICLAMP | 1.25 V to 5.0 V | | 200 | | nA |
| Clamp Input Voltage Range | | | 1.25 | | 5.0 | V |
| OUTPUT STAGE | | | | | | |
| Short-Circuit Current | I _{SC} | Source | | -45 | -25 | mA |
| | | Sink | 40 | 55 | | mA |
| Output Voltage, Low | V _{OL} | R _L = 10 kΩ to 5 V | | | 30 | mV |
| Output Voltage, High | V _{OH} | R _L = 10 kΩ to 0 V | 4.94 | | | V |
| POWER SUPPLY | | | | | | |
| Supply Current | I _{SY} | V _{POS} = V _{NEG} = 2.5 V, VDAC code = 128, V _{OUT} = 2.5 V | | 1.8 | | mA |
| Power Supply Rejection Ratio | PSRR | VDD = 2.7 V to 5.5 V | 105 | 125 | | dB |
| DYNAMIC PERFORMANCE | | | | | | |
| Gain Bandwidth Product | GBP | First gain stage, T _A = 25°C Second gain stage, T _A = 25°C | | 2 | | MHz |
| Settling Time | t _s | To 0.1%, 4 V output step | | 8 | | MHz |
| | | | | 8 | | μs |
| NOISE PERFORMANCE | | | | | | |
| Input Referred Noise | | f = 1 kHz, T _A = 25°C | | 32 | | nV/√Hz |
| Low Frequency Noise | e _{n, p-p} | f = 0.1 Hz to 10 Hz, T _A = 25°C | | 0.5 | | μV p-p |
| Total Harmonic Distortion | THD | V _{IN} = 16.75 mV rms, f = 1 kHz, T _A = 25°C | | -100 | | dB |
| DIGITAL INTERFACE | | | | | | |
| Input Current | | | | 2 | | μA |
| DIGIN Pulse Width to Load 0 | tw ₀ | T _A = 25°C | 0.05 | | 10 | μs |
| DIGIN Pulse Width to Load 1 | tw ₁ | T _A = 25°C | 50 | | | μs |
| Time Between Pulses at DIGIN | tw _s | T _A = 25°C | 10 | | | μs |
| DIGIN Low | | T _A = 25°C | | | 0.2 × VDD | V |
| DIGIN High | | T _A = 25°C | 0.8 × VDD | | | V |
| DIGOUT Logic 0 | | T _A = 25°C | | | 0.2 × VDD | V |
| DIGOUT Logic 1 | | T _A = 25°C | 0.8 × VDD | | | V |

VDD = 2.7 V, VSS = 0.0 V, V_{CM} = 1.35 V, V_{OUT} = 1.35 V, gain = 28, T_A = -40°C to +125°C, unless otherwise specified.

Table 2.

| Parameter | Symbol | Test Conditions/Comments | Min | Typ | Max | Unit |
|---|--------------------------------|---|-----------|------|-----------|-----------|
| INPUT STAGE | | | | | | |
| Input Offset Voltage | V _{OS} | | | 2 | 12 | μV |
| Input Offset Voltage Drift | T _C V _{OS} | | | | 65 | nV/°C |
| Input Bias Current | I _B | | 10 | 18 | 25 | nA |
| Input Offset Current | I _{OS} | | | 1 | 4 | nA |
| Input Voltage Range | | | 0.6 | | 1.5 | V |
| Common-Mode Rejection Ratio | CMRR | V _{CM} = 0.9 V to 1.5 V, A _V = 28 | 71 | 82 | | dB |
| | | V _{CM} = 0.9 V to 1.5 V, A _V = 1300 | 96 | 112 | | dB |
| Linearity | | V _{OUT} = 0.2 V to 1.8 V | | 20 | | ppm |
| | | V _{OUT} = 0.2 V to 2.5 V | | 1000 | | ppm |
| Differential Gain Accuracy | | Second stage gain = 10 to 250 | | | 1.6 | % |
| Differential Gain Temperature Coefficient | | Second stage gain = 10 to 250 | | 15 | 40 | ppm/°C |
| DAC | | | | | | |
| Accuracy | | Offset codes = 8 to 248 | | 0.7 | 0.8 | % |
| Ratiometricity | | Offset codes = 8 to 248 | | 50 | | ppm |
| Output Offset | | Offset codes = 8 to 248 | | 5 | 35 | mV |
| Temperature Coefficient | | | | 20 | 80 | ppm FS/°C |
| VCLAMP | | | | | | |
| Input Bias Current | ICLAMP | 1.25 V to 2.7 V | | 200 | | nA |
| Input Voltage Range | | | 1.25 | | 2.7 | V |
| OUTPUT STAGE | | | | | | |
| Short-Circuit Current | I _{SC} | Source | | -12 | -7 | mA |
| | | Sink | 15 | 25 | | mA |
| Output Voltage, Low | V _{OL} | R _L = 10 kΩ to 2.7 V | | | 30 | mV |
| Output Voltage, High | V _{OH} | R _L = 10 kΩ to 0 V | 2.64 | | | V |
| POWER SUPPLY | | | | | | |
| Supply Current | I _{SY} | V _{POS} = V _{NEG} = 1.35 V, VDAC code = 128, V _{OUT} = 1.35 V | | 1.8 | | mA |
| Power Supply Rejection Ratio | PSRR | VDD = 2.7 V to 5.5 V | 105 | 125 | | dB |
| DYNAMIC PERFORMANCE | | | | | | |
| Gain Bandwidth Product | GBP | First gain stage, T _A = 25°C Second gain stage, T _A = 25°C | | 2 | | MHz |
| Settling Time | t _s | To 0.1%, 2 V output step, T _A = 25°C | | 8 | | MHz |
| | | | | 8 | | μs |
| NOISE PERFORMANCE | | | | | | |
| Input Referred Noise | | f = 1 kHz | | 32 | | nV/√Hz |
| Low Frequency Noise | e _n p-p | f = 0.1 Hz to 10 Hz | | 0.5 | | μV p-p |
| Total Harmonic Distortion | THD | V _{IN} = 16.75 mV rms, f = 1 kHz | | -100 | | dB |
| DIGITAL INTERFACE | | | | | | |
| Input Current | | | | 2 | | μA |
| DIGIN Pulse Width to Load 0 | tw ₀ | T _A = 25°C | 0.05 | | 10 | μs |
| DIGIN Pulse Width to Load 1 | tw ₁ | T _A = 25°C | 50 | | | μs |
| Time Between Pulses at DIGIN | tw _s | T _A = 25°C | 10 | | | μs |
| DIGIN Low | | T _A = 25°C | | | 0.2 × VDD | V |
| DIGIN High | | T _A = 25°C | 0.8 × VDD | | | V |
| DIGOUT Logic 0 | | T _A = 25°C | | | 0.2 × VDD | V |
| DIGOUT Logic 1 | | T _A = 25°C | 0.8 × VDD | | | V |

ABSOLUTE MAXIMUM RATINGS

Table 3.

| Parameter | Rating |
|---|----------------------------|
| Supply Voltage | 6 V |
| Input Voltage | VSS – 0.3 V to VDD + 0.3 V |
| Differential Input Voltage ¹ | ±6.0 V |
| Output Short-Circuit Duration to VSS or VDD | Indefinite |
| ESD (Human Body Model) | 2000 V |
| Storage Temperature Range | –65°C to +150°C |
| Operating Temperature Range | –40°C to +125°C |
| Junction Temperature Range | –65°C to +150°C |
| Lead Temperature | 300°C |

¹ Differential input voltage is limited to ±5.0 V or ± the supply voltage, whichever is less.

Stresses at or above those listed under Absolute Maximum Ratings may cause permanent damage to the product. This is a stress rating only; functional operation of the product at these or any other conditions above those indicated in the operational section of this specification is not implied. Operation beyond the maximum operating conditions for extended periods may affect product reliability.

THERMAL RESISTANCE

θ_{JA} is specified for the worst-case conditions, that is, a device soldered in a circuit board for LFCSP packages.

Table 4. Thermal Resistance

| Package Type | θ_{JA} | θ_{JC} | Unit |
|--------------------|---------------|---------------|------|
| 8-Lead SOIC (R) | 158 | 43 | °C/W |
| 16-Lead LFCSP (CP) | 44 | 31.5 | °C/W |

ESD CAUTION



ESD (electrostatic discharge) sensitive device. Charged devices and circuit boards can discharge without detection. Although this product features patented or proprietary protection circuitry, damage may occur on devices subjected to high energy ESD. Therefore, proper ESD precautions should be taken to avoid performance degradation or loss of functionality.

PIN CONFIGURATIONS AND FUNCTION DESCRIPTIONS

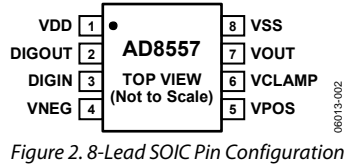
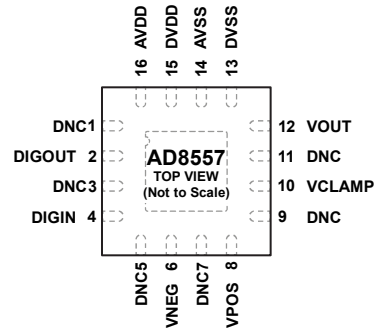

Figure 2. 8-Lead SOIC Pin Configuration



- NOTES
1. THE EXPOSED PAD SHOULD BE CONNECTED TO AVSS (PIN 14) OR LEFT UNCONNECTED.
 2. DNC = DO NOT CONNECT.

Figure 3. 16-Lead LFCSP Pin Configuration

Table 5. Pin Function Descriptions

| Pin No. | | Mnemonic | Description |
|----------------|-------------------|----------|--|
| SOIC | LFCSP | | |
| 1 | Not applicable | VDD | Positive Supply Voltage. |
| 2 | 2 | DIGOUT | Digital Output. In read mode, this pin functions as a digital output. |
| 3 | 4 | DIGIN | Digital Input. |
| 4 | 6 | VNEG | Negative Amplifier Input (Inverting Input). |
| 5 | 8 | VPOS | Positive Amplifier Input (Noninverting Input). |
| 6 | 10 | VCLAMP | Set Clamp Voltage at Output. |
| 7 | 12 | VOUT | Amplifier Output. |
| 8 | Not applicable | VSS | Negative Supply Voltage. |
| Not applicable | 13 | DVSS | Negative Supply Voltage. |
| Not applicable | 14 | AVSS | Negative Supply Voltage. |
| Not applicable | 15 | DVDD | Positive Supply Voltage. |
| Not applicable | 16 | AVDD | Positive Supply Voltage. |
| Not applicable | 1, 3, 5, 7, 9, 11 | DNC | Do Not Connect. Do not connect to these pins. |
| Not applicable | 0 | EPAD | Exposed Pad. The exposed pad should be connected to AVSS (Pin 14) or left unconnected. |

TYPICAL PERFORMANCE CHARACTERISTICS

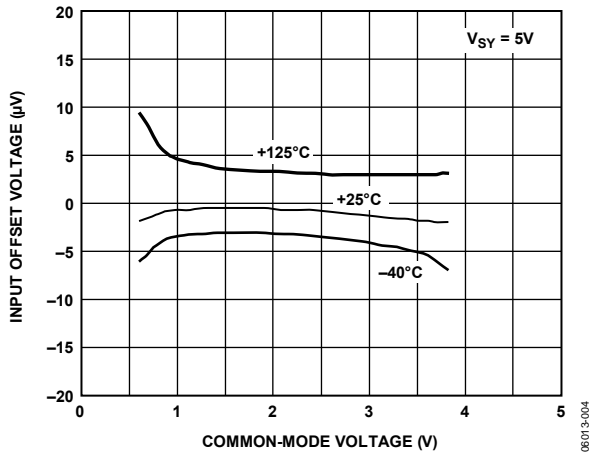

Figure 4. Input Offset Voltage vs. Common-Mode Voltage, $V_{SY} = 5V$

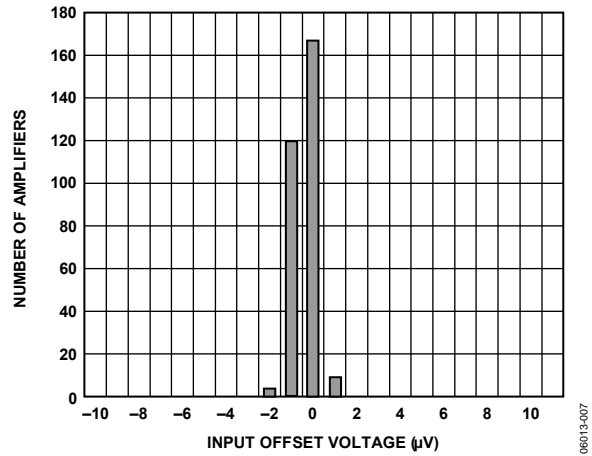

Figure 7. Input Offset Voltage Distribution, $V_{SY} = 2.7V$

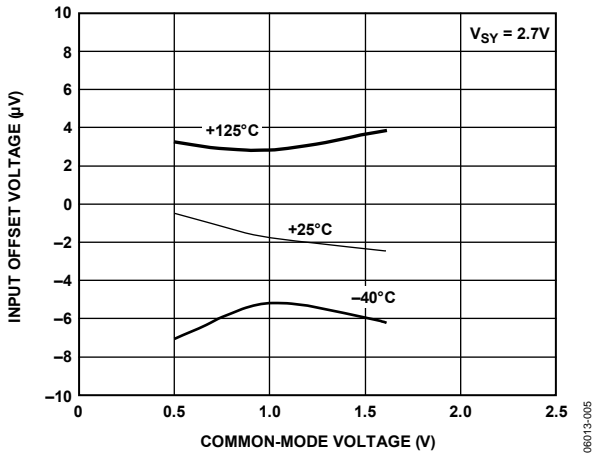

Figure 5. Input Offset Voltage vs. Common-Mode Voltage, $V_{SY} = 2.7V$

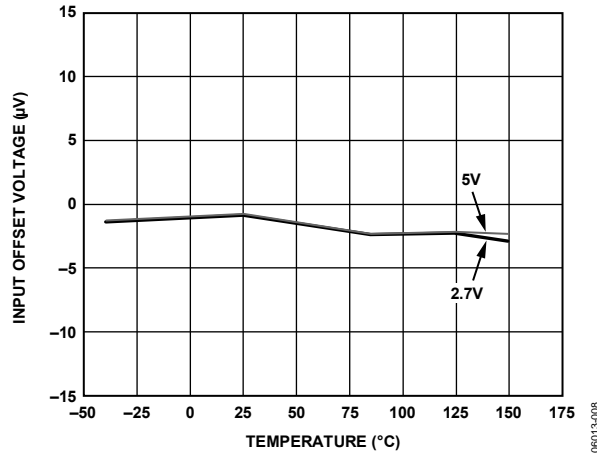

Figure 8. Input Offset Voltage vs. Temperature

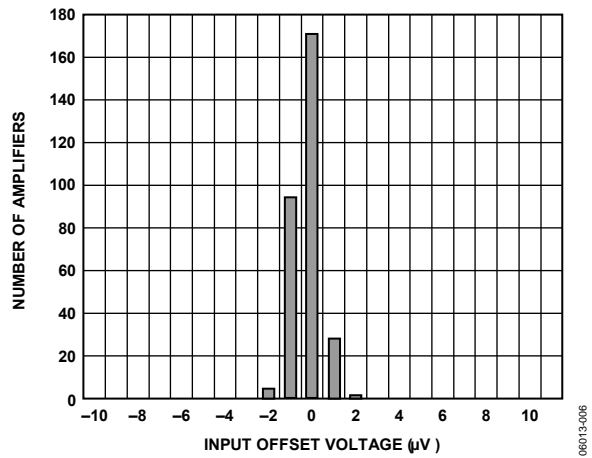

Figure 6. Input Offset Voltage Distribution, $V_{SY} = 5V$

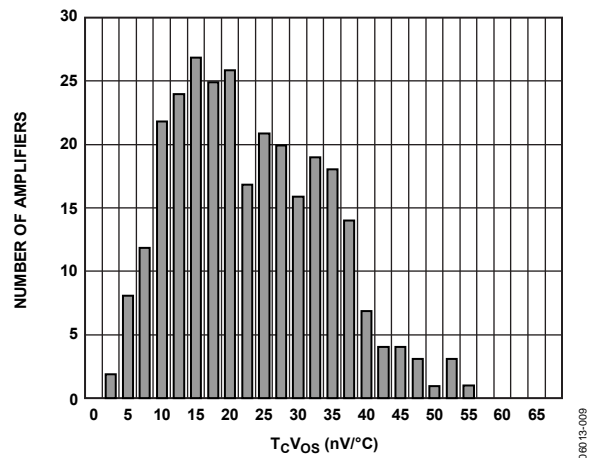

Figure 9. T_cV_{OS} at $V_{SY} = 5V$, $-40^\circ C \leq T_A \leq +125^\circ C$

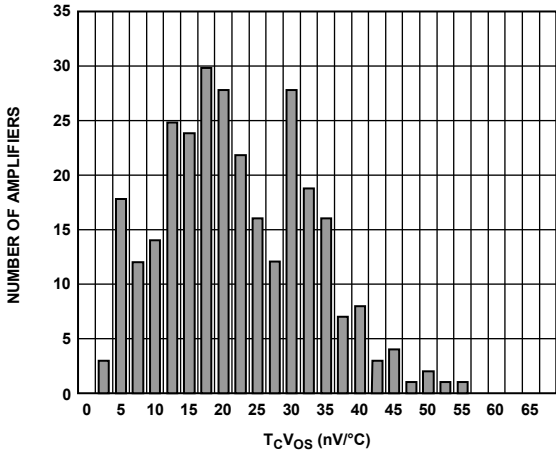

Figure 10. $T_C V_{OS}$ at $V_{SY} = 2.7V$, $-40^\circ C \leq T_A \leq +125^\circ C$

06013-010

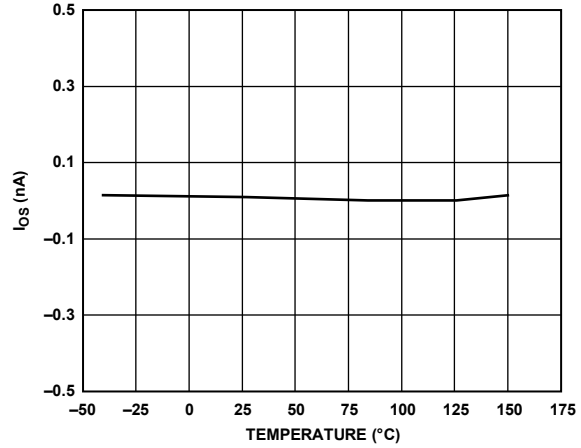

Figure 13. Input Offset Current vs. Temperature

06013-012

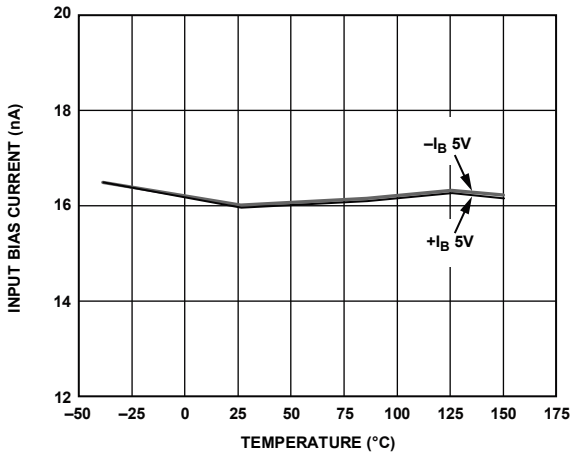

Figure 11. Input Bias Current at V_{POS} , V_{NEG} vs. Temperature, $V_{SY} = 5V$, $2.7V$

06013-011

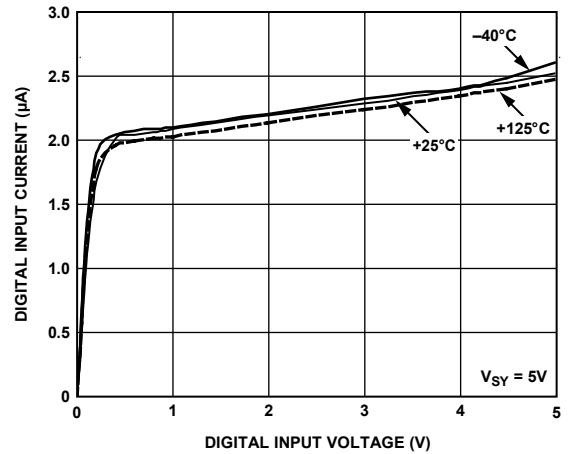

Figure 14. Digital Input Current vs. Digital Input Voltage (Pin 4)

06013-014

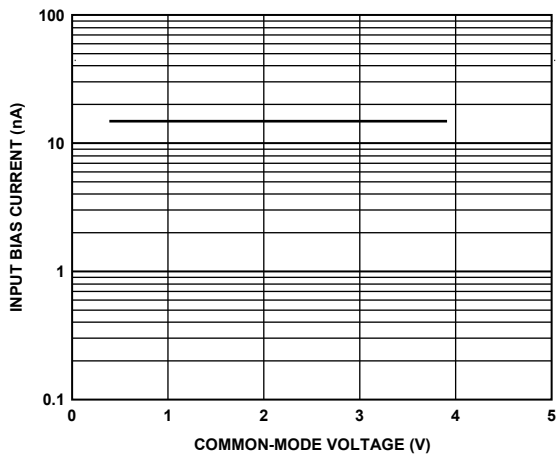

Figure 12. Input Bias Current at V_{POS} , V_{NEG} vs. Common-Mode Voltage, $T_A = 25^\circ C$

06013-013

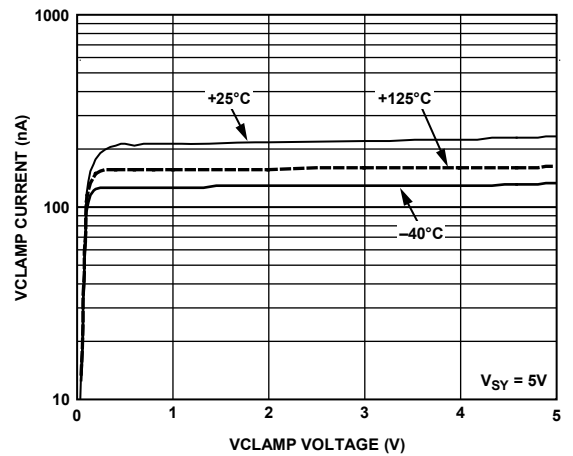

Figure 15. V_{CLAMP} Current over Temperature at $V_{SY} = 5V$ vs. V_{CLAMP} Voltage

06013-015

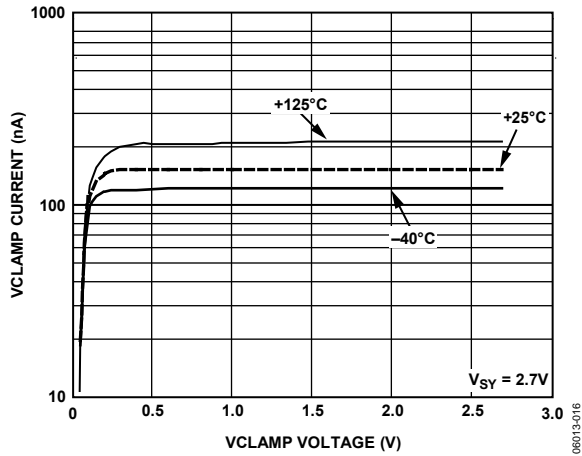

Figure 16. VCLAMP Current over Temperature at $V_{SY} = 2.7V$ vs. VCLAMP Voltage

08013-016

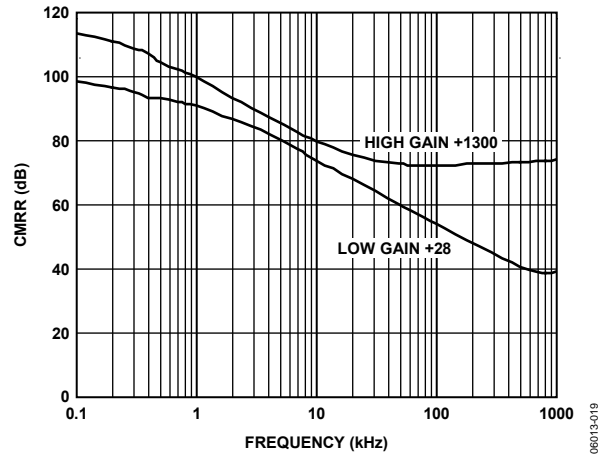

Figure 19. CMRR vs. Frequency, $V_{SY} = 5V$

08013-019

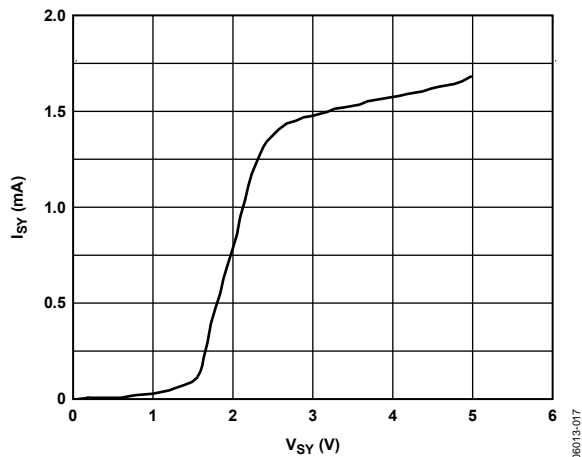

Figure 17. Supply Current (I_{SY}) vs. Supply Voltage

08013-017

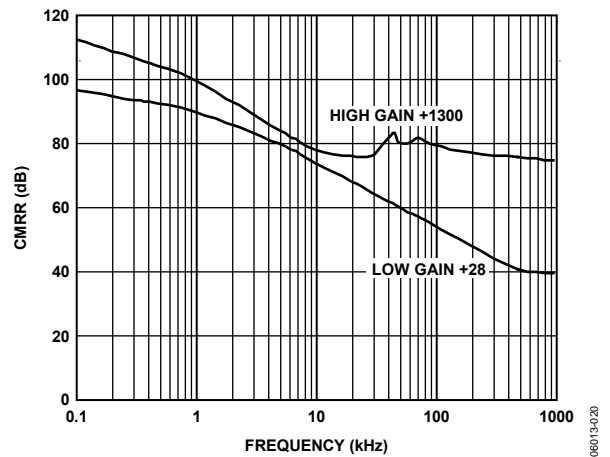

Figure 20. CMRR vs. Frequency, $V_{SY} = 2.7V$

08013-020

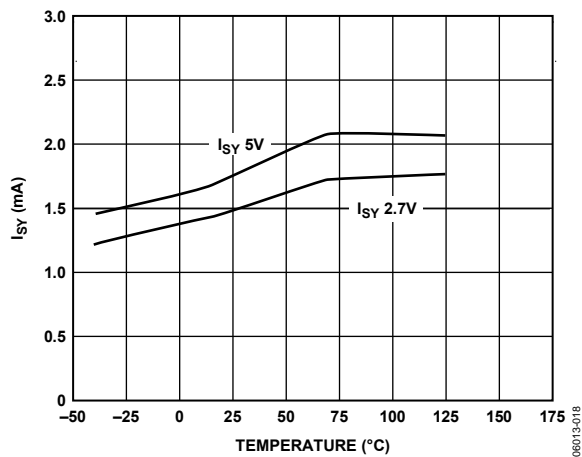

Figure 18. Supply Current (I_{SY}) vs. Temperature

08013-018

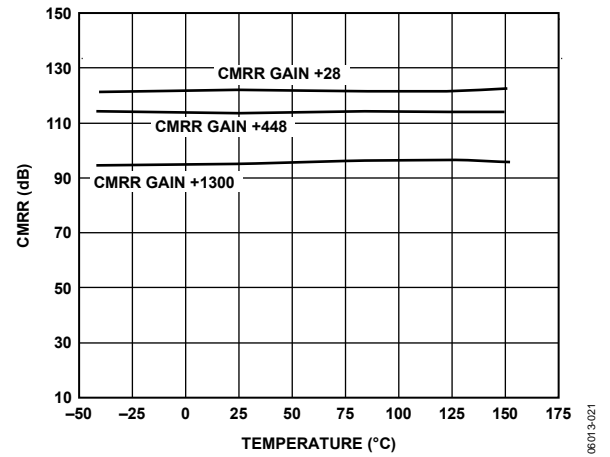

Figure 21. CMRR vs. Temperature at Different Gains, $V_{SY} = 5V$

08013-021

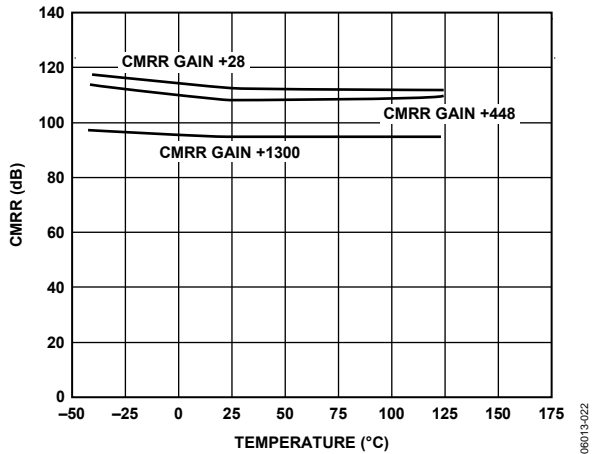

Figure 22. CMRR vs. Temperature at Different Gains, $V_{SY} = 2.7 V$

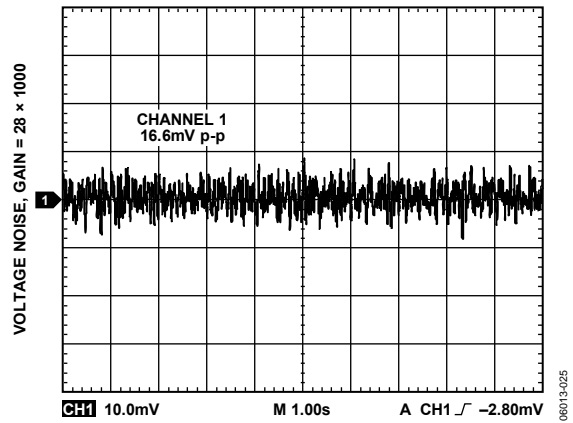

Figure 25. Low Frequency Input Voltage Noise 0.1 Hz to 10 Hz, $V_{SY} = 2.7 V$

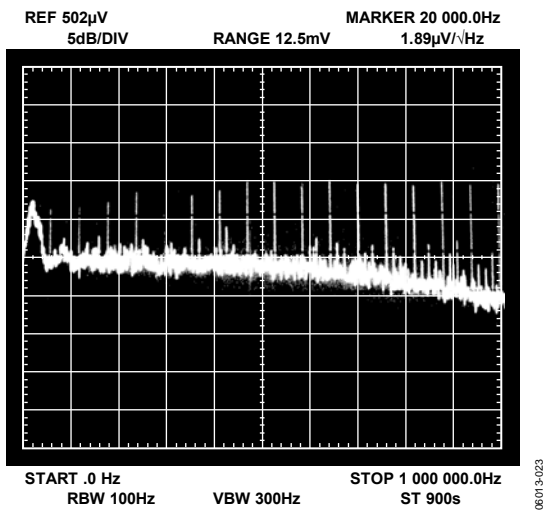

Figure 23. Input Voltage Noise Density vs. Frequency (0 Hz to 1000 kHz)

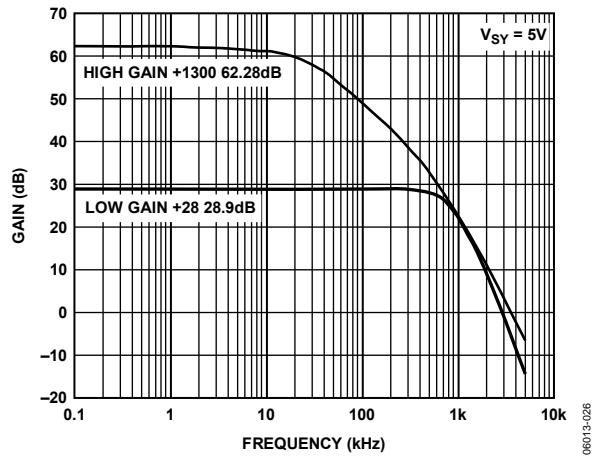

Figure 26. Closed-Loop Gain vs. Frequency Measured at Output Pin, $V_{SY} = 5 V$

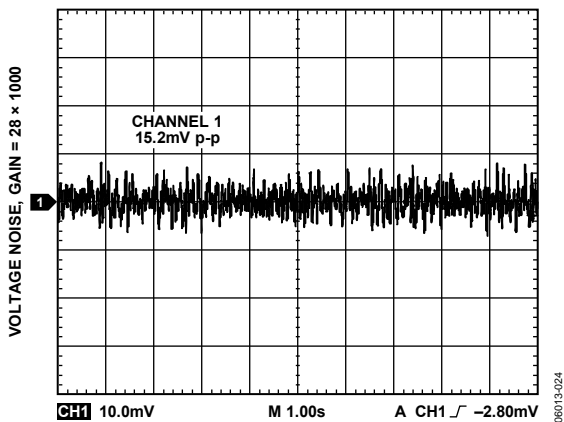

Figure 24. Low Frequency Input Voltage Noise, 0.1 Hz to 10 Hz, $V_{SY} = 5 V$

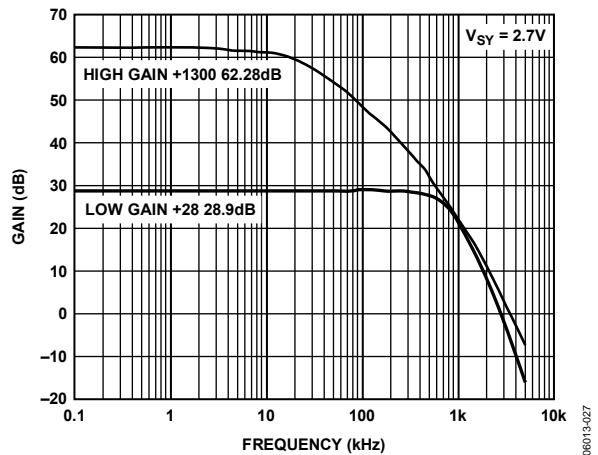

Figure 27. Closed-Loop Gain vs. Frequency Measured at Output Pin, $V_{SY} = 2.7 V$

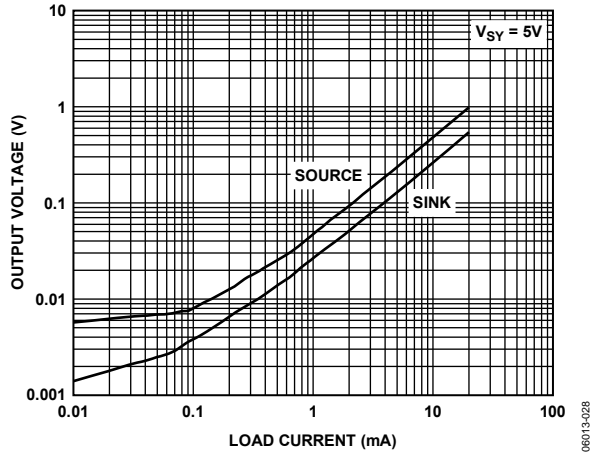

Figure 28. Output Voltage to Supply Rail vs. Load Current

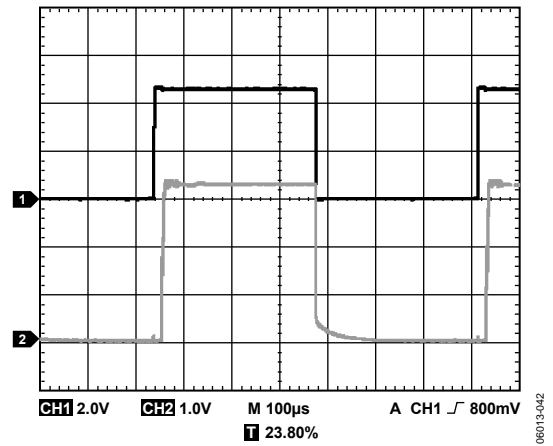

Figure 31. Power-On Response at 125°C

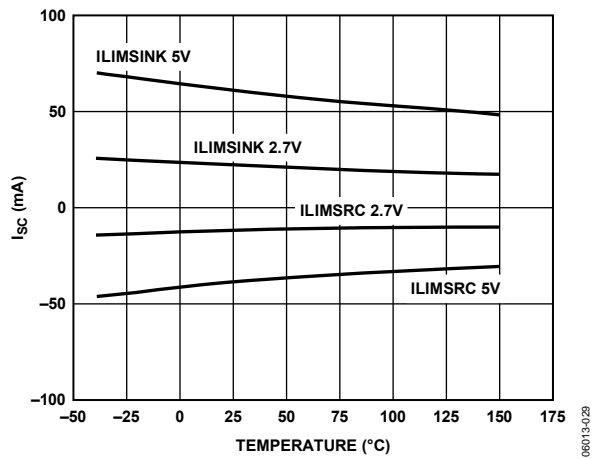

Figure 29. Output Short-Circuit vs. Temperature

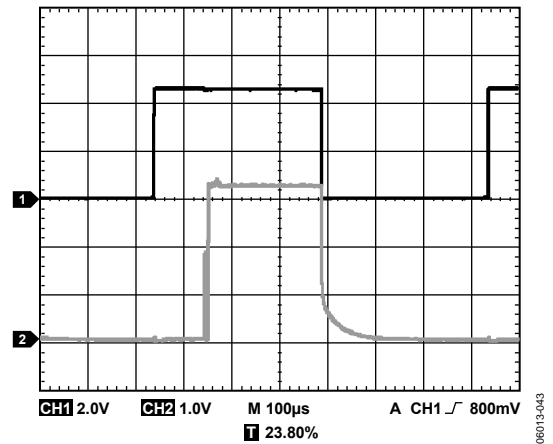

Figure 32. Power-On Response at -40°C

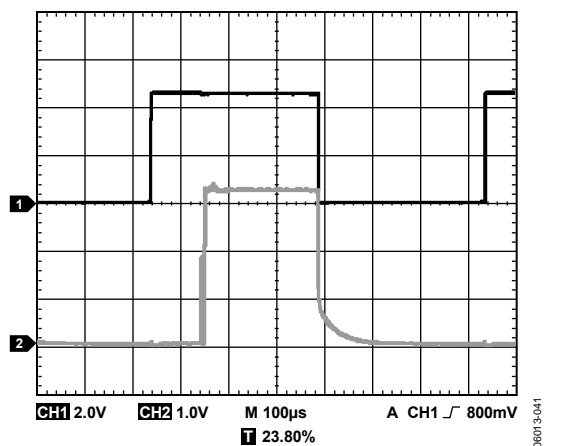

Figure 30. Power-On Response at 25°C

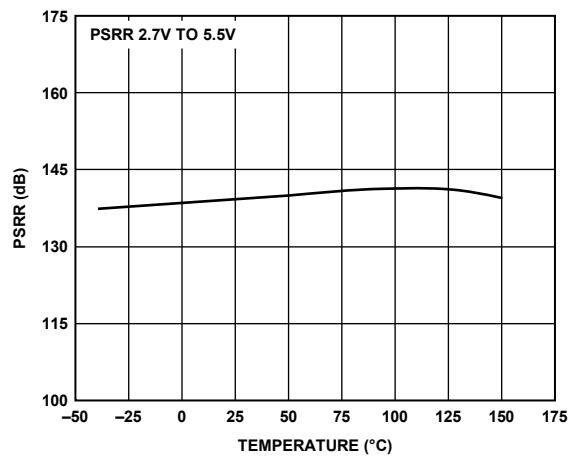

Figure 33. PSRR vs. Temperature

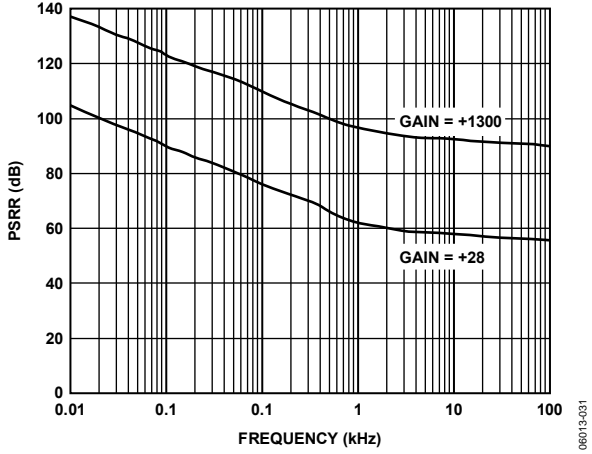

Figure 34. PSRR vs. Frequency

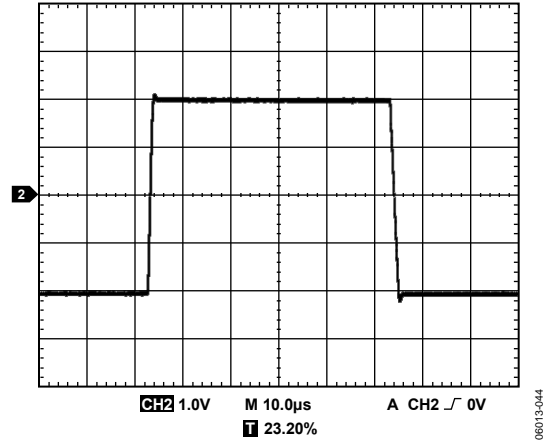

Figure 37. Large Signal Response, $C_L = 0$ pF

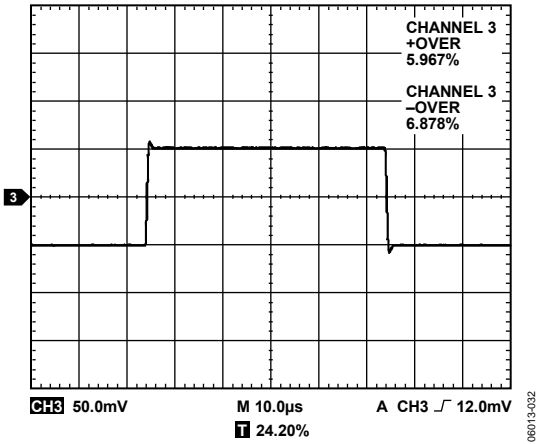

Figure 35. Small Signal Response, $V_{SY} = 5$ V, $C_L = 100$ pF

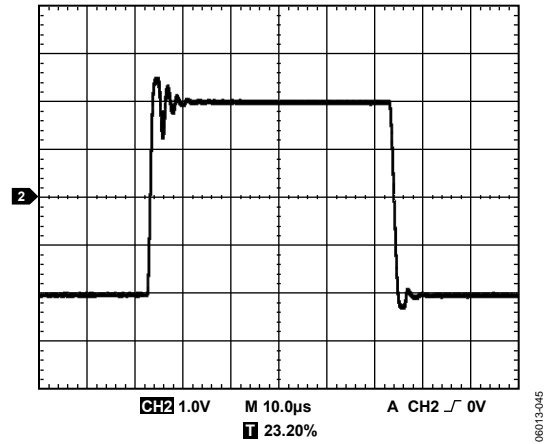

Figure 38. Large Signal Response, $C_L = 5$ nF

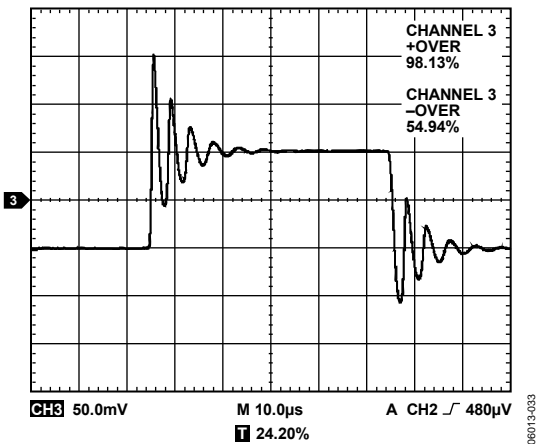

Figure 36. Small Signal Response, $V_{SY} = 5$ V, $C_L = 15$ nF

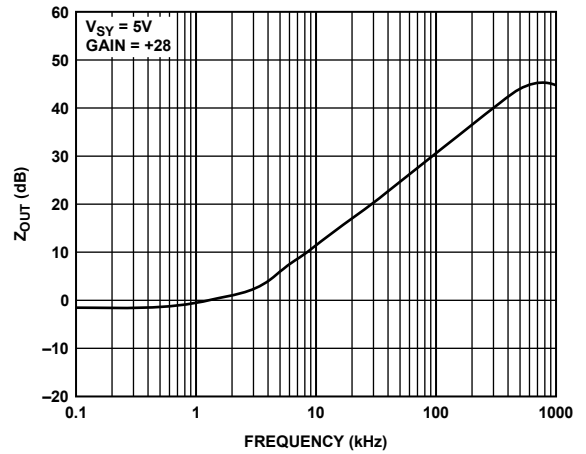

Figure 39. Output Impedance vs. Frequency

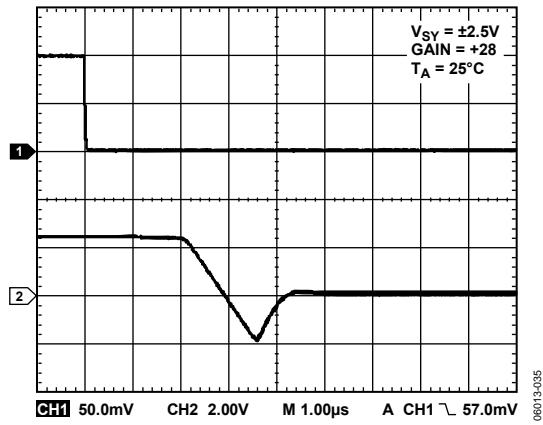

Figure 40. Positive Overload Recovery

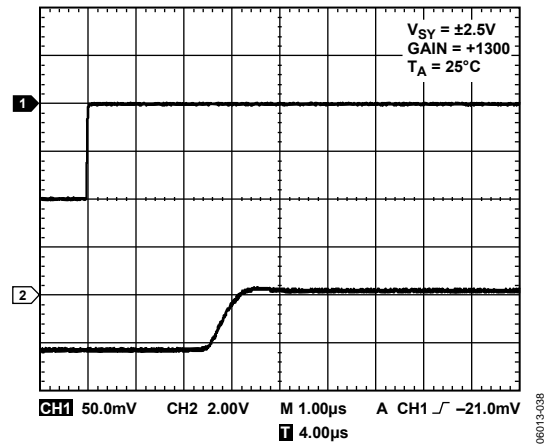

Figure 43. Positive Overload Recovery (Gain = 1300)

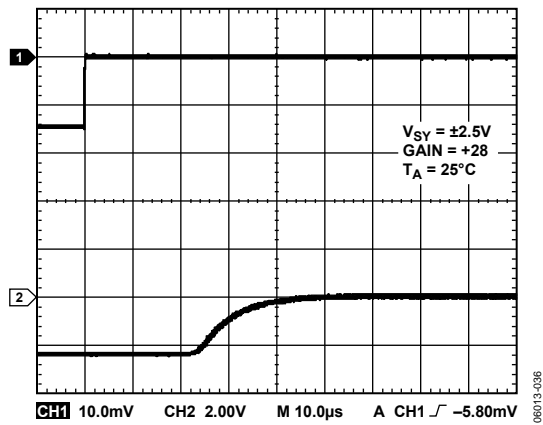

Figure 41. Negative Overload Recovery

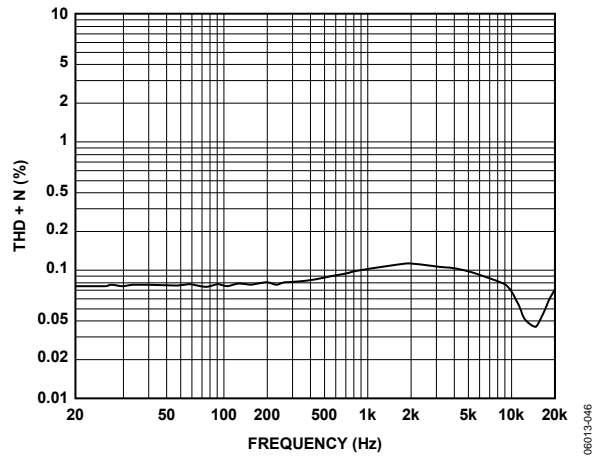

Figure 44. THD + N vs. Frequency

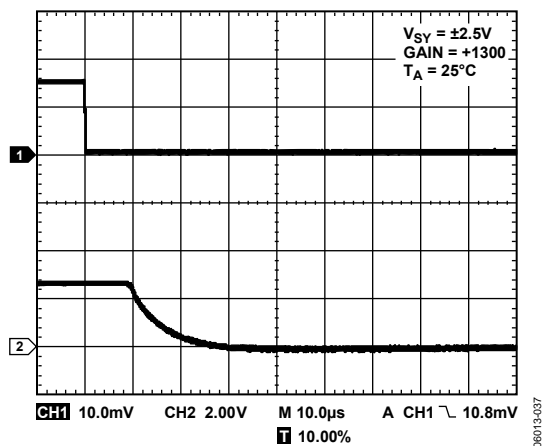

Figure 42. Negative Overload Recovery (Gain = 1300)

THEORY OF OPERATION

A1, A2, R1, R2, R3, P1, and P2 form the first gain stage of the differential amplifier. A1 and A2 are auto-zeroed op amps that minimize input offset errors. P1 and P2 are digital potentiometers, guaranteed to be monotonic. Programming P1 and P2 allows the first stage gain to be varied from 2.8 to 5.2 with 7-bit resolution (see Table 6 and Equation 1), giving a fine gain adjustment resolution of 0.49%. Because R1, R2, R3, P1, and P2 each have a similar temperature coefficient, the first stage gain temperature coefficient is lower than 100 ppm/°C.

$$GAIN1 \approx 2.8 \times \left(\frac{5.2}{2.8} \right)^{\left(\frac{Code}{127} \right)} \quad (1)$$

A3, R4, R5, R6, R7, P3, and P4 form the second gain stage of the differential amplifier. A3 is an auto-zeroed op amp that minimizes input offset errors and also includes an output buffer. P3 and P4 are digital potentiometers, which allow the second stage gain to be varied from 10 to 250 in eight steps (see Table 7). R4, R5, R6, R7, P3, and P4 each have a similar temperature coefficient, so the second stage gain temperature coefficient is lower than 100 ppm/°C. The output stage of A3 is supplied from a buffered version of VCLAMP instead of VDD, allowing the positive swing to be limited.

A4 implements a voltage buffer, which provides the positive supply to the output stage of A3. Its function is to limit VOUT to a maximum value, useful for driving analog-to-digital converters (ADC) operating on supply voltages lower than VDD. The input to A4, VCLAMP, has a very high input resistance. It should be connected to a known voltage and not be left floating. However, the high input impedance allows the clamp voltage to be set using a high impedance source, such as a potential divider. If the maximum value of VOUT does not need to be limited, VCLAMP should be connected to VDD.

An 8-bit digital-to-analog converter (DAC) is used to generate a variable offset for the amplifier output. This DAC is guaranteed

to be monotonic. To preserve the ratiometric nature of the input signal, the DAC references are driven from VSS and VDD, and the DAC output can swing from VSS (Code 0) to VDD (Code 255). The 8-bit resolution is equivalent to 0.39% of the difference between VDD and VSS, for example, 19.5 mV with a 5 V supply. The DAC output voltage (VDAC) is given approximately by

$$VDAC \approx \left(\frac{Code + 0.5}{256} \right) (VDD - VSS) + VSS \quad (2)$$

where the temperature coefficient of VDAC is lower than 200 ppm/°C.

The amplifier output voltage (VOUT) is given by

$$VOUT = GAIN(VPOS - VNEG) + VDAC \quad (3)$$

where GAIN is the product of the first and second stage gains.

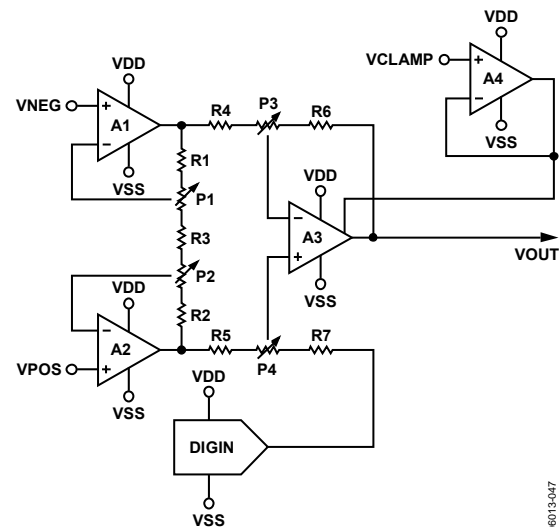

Figure 45. Functional Schematic

06013-047

GAIN VALUES

Table 6. First Stage Gain vs. First Stage Gain Code

| First Stage Gain Code | First Stage Gain | First Stage Gain Code | First Stage Gain | First Stage Gain Code | First Stage Gain | First Stage Gain Code | First Stage Gain |
|-----------------------|------------------|-----------------------|------------------|-----------------------|------------------|-----------------------|------------------|
| 0 | 2.800 | 32 | 3.273 | 64 | 3.825 | 96 | 4.471 |
| 1 | 2.814 | 33 | 3.289 | 65 | 3.844 | 97 | 4.493 |
| 2 | 2.827 | 34 | 3.305 | 66 | 3.863 | 98 | 4.515 |
| 3 | 2.841 | 35 | 3.321 | 67 | 3.881 | 99 | 4.537 |
| 4 | 2.855 | 36 | 3.337 | 68 | 3.900 | 100 | 4.559 |
| 5 | 2.869 | 37 | 3.353 | 69 | 3.919 | 101 | 4.581 |
| 6 | 2.883 | 38 | 3.370 | 70 | 3.939 | 102 | 4.603 |
| 7 | 2.897 | 39 | 3.386 | 71 | 3.958 | 103 | 4.626 |
| 8 | 2.911 | 40 | 3.403 | 72 | 3.977 | 104 | 4.649 |
| 9 | 2.926 | 41 | 3.419 | 73 | 3.997 | 105 | 4.671 |
| 10 | 2.940 | 42 | 3.436 | 74 | 4.016 | 106 | 4.694 |
| 11 | 2.954 | 43 | 3.453 | 75 | 4.036 | 107 | 4.717 |
| 12 | 2.969 | 44 | 3.470 | 76 | 4.055 | 108 | 4.740 |
| 13 | 2.983 | 45 | 3.487 | 77 | 4.075 | 109 | 4.763 |
| 14 | 2.998 | 46 | 3.504 | 78 | 4.095 | 110 | 4.786 |
| 15 | 3.012 | 47 | 3.521 | 79 | 4.115 | 111 | 4.810 |
| 16 | 3.027 | 48 | 3.538 | 80 | 4.135 | 112 | 4.833 |
| 17 | 3.042 | 49 | 3.555 | 81 | 4.156 | 113 | 4.857 |
| 18 | 3.057 | 50 | 3.573 | 82 | 4.176 | 114 | 4.881 |
| 19 | 3.072 | 51 | 3.590 | 83 | 4.196 | 115 | 4.905 |
| 20 | 3.087 | 52 | 3.608 | 84 | 4.217 | 116 | 4.929 |
| 21 | 3.102 | 53 | 3.625 | 85 | 4.237 | 117 | 4.953 |
| 22 | 3.117 | 54 | 3.643 | 86 | 4.258 | 118 | 4.977 |
| 23 | 3.132 | 55 | 3.661 | 87 | 4.279 | 119 | 5.001 |
| 24 | 3.147 | 56 | 3.679 | 88 | 4.300 | 120 | 5.026 |
| 25 | 3.163 | 57 | 3.697 | 89 | 4.321 | 121 | 5.050 |
| 26 | 3.178 | 58 | 3.715 | 90 | 4.342 | 122 | 5.075 |
| 27 | 3.194 | 59 | 3.733 | 91 | 4.363 | 123 | 5.100 |
| 28 | 3.209 | 60 | 3.751 | 92 | 4.384 | 124 | 5.125 |
| 29 | 3.225 | 61 | 3.770 | 93 | 4.406 | 125 | 5.150 |
| 30 | 3.241 | 62 | 3.788 | 94 | 4.427 | 126 | 5.175 |
| 31 | 3.257 | 63 | 3.806 | 95 | 4.449 | 127 | 5.200 |

Table 7. Second Stage Gain and Gain Ranges vs. Second Stage Gain Code

| Second Stage Gain Code | Second Stage Gain | Minimum Combined Gain | Maximum Combined Gain |
|------------------------|-------------------|-----------------------|-----------------------|
| 0 | 10 | 28.0 | 52.0 |
| 1 | 16 | 44.8 | 83.2 |
| 2 | 25 | 70.0 | 130.0 |
| 3 | 40 | 112.0 | 208.0 |
| 4 | 63 | 176.4 | 327.6 |
| 5 | 100 | 280.0 | 520.0 |
| 6 | 160 | 448.0 | 832.0 |
| 7 | 250 | 700.0 | 1300.0 |

OPEN WIRE FAULT DETECTION

The inputs to A1 and A2, VNEG and VPOS, each have a comparator to detect whether VNEG or VPOS exceeds a threshold voltage, nominally $VDD - 1.1\text{ V}$. If $VNEG > (VDD - 1.1\text{ V})$ or $VPOS > (VDD - 1.1\text{ V})$, VOUT is clamped to VSS. The output current limit circuit is disabled in this mode, but the maximum sink current is approximately 10 mA when $VDD = 5\text{ V}$. The inputs to A1 and A2, VNEG and VPOS, are also pulled up to VDD by currents IP1 and IP2. These are both nominally 16 nA and matched to within 3 nA. If the inputs to A1 or A2 are accidentally left floating, as with an open wire fault, IP1 and IP2 pull them to VDD, which would cause VOUT to swing to VSS, allowing this fault to be detected. It is not possible to disable IP1 and IP2, nor the clamping of VOUT to VSS, when VNEG or VPOS approaches VDD.

SHORTED WIRE FAULT DETECTION

The AD8557 provides fault detection in the case where VPOS, VNEG, or VCLAMP shorts to VDD and VSS. Figure 46 shows the voltage regions at VPOS, VNEG, and VCLAMP that trigger an error condition. When an error condition occurs, the VOUT pin is shorted to VSS. Table 8 lists the voltage levels shown in Figure 46.

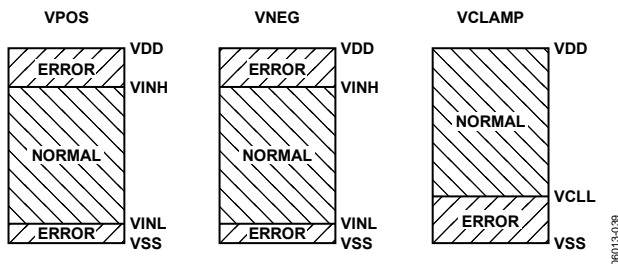

Figure 46. Voltage Regions at VPOS, VNEG, and VCLAMP that Trigger a Fault Condition

Table 8. Typical VINL, VINH, and VCLL Values (VDD = 5 V)

| Voltage | Min (V) | Max (V) | VOUT Condition |
|---------|---------|---------|------------------------------|
| VINH | 3.9 | 4.2 | Short to VDD fault detection |
| VINL | 0.195 | 0.55 | Short to VSS fault detection |
| VCLL | 1.0 | 1.2 | Short to VSS fault detection |

FLOATING VPOS, VNEG, OR VCLAMP FAULT DETECTION

A floating fault condition at the VPOS, VNEG, or VCLAMP pins is detected by using a low current to pull a floating input into an error voltage range, defined in the previous section. In this way, the VOUT pin is shorted to VSS when a floating input is detected. Table 9 lists the currents used.

Table 9. Floating Fault Detection at VPOS, VNEG, and VCLAMP

| Pin | Typical Current | Goal of Current |
|--------|-----------------------------|------------------------|
| VPOS | 16 nA pull-up | Pull VPOS above VINH |
| VNEG | 16 nA pull-up | Pull VNEG above VINH |
| VCLAMP | 0.2 μA pull-down | Pull VCLAMP below VCLL |

DEVICE PROGRAMMING

Digital Interface

The digital interface allows the first stage gain, second stage gain, and output offset to be adjusted and allows desired values for these parameters to be permanently stored by selectively blowing polysilicon fuses. To minimize pin count and board space, a single-wire digital interface is used. The digital input pin, DIGIN, has hysteresis to minimize the possibility of inadvertent triggering with slow signals. It also has a pull-down current sink to allow it to be left floating when programming is not being performed. The pull-down ensures inactive status of the digital input by forcing a dc low voltage on DIGIN.

A short pulse at DIGIN from low to high and back to low again, such as between 50 ns and 10 μs long, loads a 0 into a shift register. A long pulse at DIGIN, such as 50 μs or longer, loads a 1 into the shift register. The time between pulses should be at least 10 μs . Assuming $VSS = 0\text{ V}$, voltages at DIGIN between VSS and $0.2 \times VDD$ are recognized as a low, and voltages at DIGIN between $0.8 \times VDD$ and VDD are recognized as a high. A timing diagram example, Figure 47, shows the waveform for entering Code 010011 into the shift register.

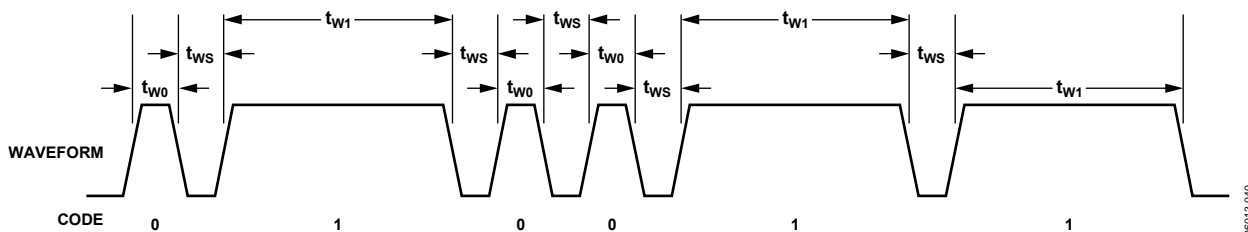

Figure 47. Timing Diagram for Code 010011

Table 10. Timing Specifications

| Timing Parameter | Description | Specification |
|------------------|---|------------------------------|
| t_{w0} | Pulse width for loading 0 into shift register | Between 50 ns and 10 μ s |
| t_{w1} | Pulse width for loading 1 into shift register | $\geq 50 \mu$ s |
| t_{ws} | Width between pulses | $\geq 10 \mu$ s |

Table 11. 38-Bit Serial Word Format

| Field No. | Bits | Description |
|-----------|----------|---|
| 0 | 0 to 11 | 12-bit start of packet 1000 0000 0001 |
| 1 | 12 to 13 | 2-bit function 00: change sense current 01: simulate parameter value 10: program parameter value 11: read parameter value |
| 2 | 14 to 15 | 2-bit parameter 00: second stage gain code 01: first stage gain code 10: output offset code 11: other functions |
| 3 | 16 to 17 | 2-bit dummy 10 |
| 4 | 18 to 25 | 8-bit value Parameter 00 (second stage gain code): 3 LSBs used Parameter 01 (first stage gain code): 7 LSBs used Parameter 10 (output offset code): all 8 bits used Parameter 11 (other functions) Bit 0 (LSB): master fuse Bit 1: fuse for production test at Analog Devices |
| 5 | 26 to 37 | 12-bit end of packet 0111 1111 1110 |

A 38-bit serial word is used, divided into 6 fields. Assuming each bit can be loaded in 60 μ s, the 38-bit serial word transfers in 2.3 ms. Table 11 summarizes the word format.

Field 0 and Field 5 are the start-of-packet field and end-of-packet field, respectively. Matching the start-of-packet field with 1000 0000 0001 and the end-of-packet field with 0111 1111 1110 ensures that the serial word is valid and enables decoding of the other fields.

Field 3 breaks up the data and ensures that no data combination can inadvertently trigger the start-of-packet and end-of-packet fields. Field 0 should be written first and Field 5 written last.

Within each field, the MSB must be written first and the LSB written last. The shift register features power-on reset to minimize the risk of inadvertent programming; power-on reset occurs when VDD is between 0.7 V and 2.2 V.

Initial State

Initially, all the polysilicon fuses are intact. Each parameter has the value 0 assigned (see Table 12).

Table 12. Initial State Before Programming

| Second Stage Gain Code = 0 | Second Stage Gain = 10 |
|----------------------------|------------------------|
| First stage gain code = 0 | First stage gain = 2.8 |
| Output offset code = 0 | Output offset = VSS |
| Master fuse = 0 | Master fuse not blown |

When power is applied to a device, parameter values are taken either from internal registers, if the master fuse is not blown, or from the polysilicon fuses, if the master fuse is blown. Programmed values have no effect until the master fuse is blown. The internal registers feature power-on reset, so the unprogrammed devices enter a known state after power-up. Power-on reset occurs when VDD is between 0.7 V and 2.2 V.

Simulation Mode

The simulation mode allows any parameter to be temporarily changed. These changes are retained until the simulated value is reprogrammed, the power is removed, or the master fuse is blown. Parameters are simulated by setting Field 1 to 01, selecting the desired parameter in Field 2, and selecting the desired value for the parameter in Field 4. Note that a value of 11 for Field 2 is ignored during the simulation mode. Examples of temporary settings follow:

- Setting the second stage gain code (Parameter 00) to 011 and the second stage gain to 40 produces:
1000 0000 0001 01 00 10 0000 0011 0111 1111 1110
- Setting the first stage gain code (Parameter 01) to 000 1011 and the first stage gain to 4.166 produces:
1000 0000 0001 01 01 10 0000 1011 0111 1111 1110
- A first stage gain of 2.954 with a second stage gain of 40 gives a total gain of 118.16. This gain has a maximum tolerance of 2.5%.
- Set the output offset code (Parameter 10) to 0100 0000 and the output offset to 1.260 V when VDD = 5 V and VSS = 0 V. This output offset has a maximum tolerance of 0.8%:
1000 0000 0001 01 10 10 0100 0000 0111 1111 1110

Programming Mode

Intact fuses give a bit value of 0. Bits with a desired value of 1 need to have the associated fuse blown. Because a relatively large current is needed to blow a fuse, only one fuse can be reliably blown at a time. Thus, a given parameter value may need several 38-bit words to allow reliable programming.

A 5.75 V (± 0.25 V) supply is required when blowing fuses to minimize the on resistance of the internal MOS switches that blow the fuse. The power supply voltage must not exceed the absolute maximum rating and must be able to deliver 250 mA of current.

At least 10 μ F (tantalum type) of decoupling capacitance is needed across the power pins of the device during programming. The capacitance can be on the programming apparatus as long as it is within 2 inches of the device being programmed. An additional 0.1 μ F (ceramic type) in parallel with the 10 μ F is recommended within $\frac{1}{2}$ inch of the device being programmed. A minimum period of 1 ms should be allowed for each fuse to blow. There is no need to measure the supply current during programming.

The best way to verify correct programming is to use the read mode to read back the programmed values. Then, remeasure the gain and offset to verify these values. Programmed fuses have no effect on the gain and output offset until the master fuse is blown. After blowing the master fuse, the gain and output offset are determined solely by the blown fuses, and the simulation mode is permanently deactivated.

Parameters are programmed by setting Field 1 to 10, selecting the desired parameter in Field 2, and selecting a single bit with the value 1 in Field 4.

As an example, suppose the user wants to permanently set the second stage gain to 40. Parameter 00 needs to have the value 0000 0011 assigned. Two bits have the value 1, so two fuses need to be blown. Because only one fuse can be blown at a time, this code can be used to blow one fuse:

```
1000 0000 0001 10 00 10 0000 0010 0111 1111 1110
```

The MOS switch that blows the fuse closes when the complete packet is recognized, and opens when the start-of-packet, dummy, or end-of-packet fields are no longer valid. After 1 ms, this second code is entered to blow the second fuse:

```
1000 0000 0001 10 00 10 0000 0001 0111 1111 1110
```

To permanently set the first stage gain to a nominal value of 2.954, Parameter 01 needs to have the value 000 1011 assigned. Three fuses need to be blown, and the following codes are used, with a 1 ms delay after each code:

```
1000 0000 0001 10 01 10 0000 1000 0111 1111 1110
```

```
1000 0000 0001 10 01 10 0000 0010 0111 1111 1110
```

```
1000 0000 0001 10 01 10 0000 0001 0111 1111 1110
```

To permanently set the output offset to a nominal value of 1.260 V when VDD = 5 V and VSS = 0 V, Parameter 10 needs to have the value 0100 0000 assigned. If one fuse needs to be blown, use the following code:

```
1000 0000 0001 10 10 10 0100 0000 0111 1111 1110
```

Finally, to blow the master fuse to deactivate the simulation mode and prevent further programming, use code:

```
1000 0000 0001 10 11 10 0000 0001 0111 1111 1110
```

There are a total of 20 programmable fuses. Because each fuse requires 1 ms to blow, and each serial word can be loaded in 2.3 ms, the maximum time needed to program the fuses can be as low as 66 ms.

Read Mode

The values stored by the polysilicon fuses can be sent to the DIGOUT pin to verify correct programming. Normally, the DIGOUT pin is only connected to the second gain stage output. During read mode, however, the DIGOUT pin is also connected to the output of a shift register to allow the polysilicon fuse contents to be read. Because VOUT is a buffered version of DIGOUT, VOUT also outputs a digital signal during read mode.

Read mode is entered by setting Field 1 to 11 and selecting the desired parameter in Field 2. Field 4 is ignored. The parameter value, stored in the polysilicon fuses, is loaded into an internal shift register, and the MSB of the shift register is connected to the DIGOUT pin. Pulses at DIGIN shift out the shift register contents to the DIGOUT pin, allowing the 8-bit parameter value to be read after seven additional pulses; shifting occurs on the falling edge of DIGIN. An eighth pulse at DIGIN disconnects DIGOUT from the shift register and terminates the read mode.

If a parameter value is less than eight bits long, the MSBs of the shift register are padded with 0s.

For example, to read the second stage gain, this code is used:
1000 0000 0001 11 00 10 0000 0000 0111 1111 1110

Because the second stage gain parameter value is only three bits long, the DIGOUT pin has a value of 0 when this code is entered, and remains 0 during four additional pulses at DIGIN. The fifth, sixth, and seventh pulses at DIGIN return the 3-bit value at DIGOUT, the seventh pulse returns the LSB. An eighth pulse at DIGIN terminates the read mode.

Sense Current

A sense current is sent across each polysilicon fuse to determine whether it has been blown. When the voltage across the fuse is less than approximately 1.5 V, the fuse is considered not blown, and Logic 0 is output from the OTP cell. When the voltage across the fuse is greater than approximately 1.5 V, the fuse is considered blown, and Logic 1 is output.

When the AD8557 is manufactured, all fuses have a low resistance. When a sense current is sent through the fuse, a voltage less than 0.1 V is developed across the fuse. This is much lower than 1.5 V, so Logic 0 is output from the OTP cell. When a fuse is electrically blown, it should have a very high resistance. When the sense current is applied to the blown fuse, the voltage across the fuse should be larger than 1.5 V, so Logic 1 is output from the OTP cell.

It is theoretically possible, though very unlikely, for a fuse to be incompletely blown during programming, assuming the required conditions are met. In this situation, the fuse can have a medium resistance, neither low nor high, and a voltage of approximately 1.5 V can be developed across the fuse. Thus, the OTP cell can output Logic 0 or Logic 1, depending on temperature, supply voltage, and other variables.

To detect this undesirable situation, the sense current can be lowered by a factor of 4 using a specific code. The voltage developed across the fuse would then change from 1.5 V to 0.38 V, and the output of the OTP would be a Logic 0 instead of the expected Logic 1 from a blown fuse. Correctly blown fuses would still output a Logic 1. In this way, incorrectly blown fuses can be detected. Another specific code would return the sense current to the normal (larger) value. The sense current cannot be permanently programmed to the low value. When the AD8557 is powered up, the sense current defaults to the high value.

The low sense current code is

1000 0000 0001 00 00 10 XXXX XXX1 0111 1111 1110

The normal (high) sense current code is

1000 0000 0001 00 00 10 XXXX XXX0 0111 1111 1110

Programming Procedure

For reliable fuse programming, it is imperative to follow the programming procedure requirements, especially the proper supply voltage during programming:

1. When programming the AD8557, the temperature of the device must be between 10°C to 40°C.
2. Set VDD and VSS to the desired values in the application. Use simulation mode to test and determine the desired codes for the second stage gain, first stage gain, and output offset. The nominal values for these parameters are shown in Table 6, Table 7, Equation 2, and Equation 3; use the codes corresponding to these values as a starting point. However, because actual parameter values for given codes vary from device to device, some fine tuning is necessary for the best possible accuracy.
3. One way to choose these values is to set the output offset to an approximate value, such as Code 128 for midsupply, to allow the required gain to be determined. Then, set the second stage gain so the minimum first stage gain (Code 0) gives a lower gain than required, and the maximum first stage gain (Code 127) gives a higher gain than required. After choosing the second stage gain, the first stage gain can be chosen to fine tune the total gain. Finally, the output offset can be adjusted to give the desired value. After determining the desired codes for second stage gain, first stage gain, and output offset, the device is ready for permanent programming.
4. Note that once a programming attempt has been made for any fuse, there should be no further attempt to blow that fuse. If a fuse does not program to the expected state, discard the unit. The expected incidence rate of attempted but unblown fuses is very small when following the proper programming procedure and conditions.
5. Set VSS to 0 V and VDD to 5.75 V (± 0.25 V). Power supplies should be capable of supplying 250 mA at the required voltage and properly bypassed as described in the Programming Mode section. Use program mode to permanently enter the desired codes for the first stage gain, second stage gain, and output offset. Blow the master fuse to allow the AD8557 to read data from the fuses and to prevent further programming.
6. Set VDD and VSS to the desired values in the application. Use read mode with low sense current followed by high sense current to verify programmed codes.
7. Measure gain and offset to verify correct functionality.

Determining Optimal Gain and Offset Codes

First, determine the desired gain:

1. Determine the desired gain, G_A (using the measurements obtained from the simulation).
2. Use Table 7 to determine G_2 , the second stage gain, such that $(2.8 \times 1.05) < (G_A/G_2) < (5.2/1.05)$. This ensures the first and last codes for the first stage gain are not used, thereby allowing enough first stage gain codes within each second stage gain range to adjust for the 3% accuracy.

Next, set the second stage gain:

1. Use the simulation mode to set the second stage gain to G_2 .
2. Set the output offset to allow the AD8557 gain to be measured, for example, use Code 128 to set it to midsupply.
3. Use Table 6 or Equation 1 to set the first stage gain code C_{G1} , so the first stage gain is nominally G_A/G_2 .
4. Measure the resulting gain (G_B). G_B should be within 3% of G_A .
5. Calculate the first stage gain error (in relative terms) $E_{G1} = G_B/G_A - 1$.
6. Calculate the error (in the number of the first stage gain codes) $C_{EG1} = E_{G1}/0.00489$.
7. Set the first stage gain code to $C_{G1} - C_{EG1}$.
8. Measure the gain (G_C). G_C should be closer to G_A than to G_B .

9. Calculate the error (in relative terms) $E_{G2} = G_C/G_A - 1$.
10. Calculate the error (in the number of the first stage gain codes) $C_{EG2} = E_{G2}/0.00489$.
11. Set the first stage gain code to $C_{G1} - C_{EG1} - C_{EG2}$. The resulting gain should be within one code of G_A .
12. Finally, determine the desired output offset:
13. Determine the desired output offset O_A (using the measurements obtained from the simulation).
14. Use Equation 2 to set the output offset code C_{O1} such that the output offset is nominally O_A .
15. Measure the output offset (O_B). O_B should be within 3% of O_A .
16. Calculate the error (in relative terms) $E_{O1} = O_B/O_A - 1$.
17. Calculate the error (in the number of the output offset codes) $C_{EO1} = E_{O1}/0.00392$.
18. Set the output offset code to $C_{O1} - C_{EO1}$.
19. Measure the output offset (O_C). O_C should be closer to O_A than to O_B .
20. Calculate the error (in relative terms) $E_{O2} = O_C/O_A - 1$.
21. Calculate the error (in the number of the output offset codes) $C_{EO2} = E_{O2}/0.00392$.
22. Set the output offset code to $C_{O1} - C_{EO1} - C_{EO2}$. The resulting offset should be within one code of O_A .

OUTLINE DIMENSIONS

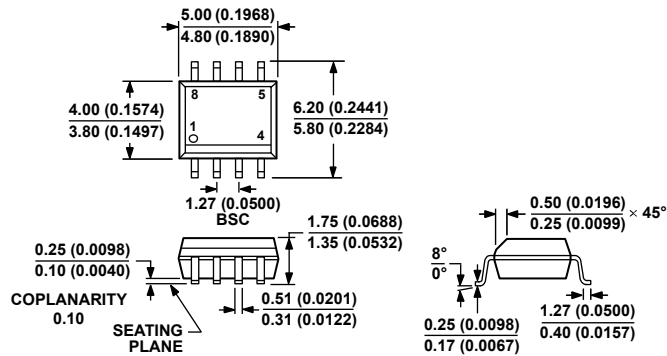

COMPLIANT TO JEDEC STANDARDS MS-012-AA
 CONTROLLING DIMENSIONS ARE IN MILLIMETERS; INCH DIMENSIONS
 (IN PARENTHESES) ARE ROUNDED-OFF MILLIMETER EQUIVALENTS FOR
 REFERENCE ONLY AND ARE NOT APPROPRIATE FOR USE IN DESIGN.

Figure 48. 8-Lead Standard Small Outline Package [SOIC_N]
 Narrow Body
 (R-8)

Dimensions shown in millimeters and (inches)

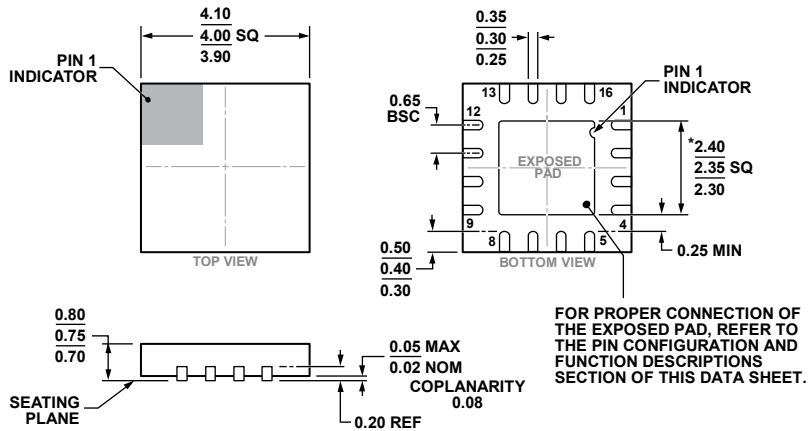

*COMPLIANT TO JEDEC STANDARDS MO-220-WGGC-3
 WITH EXCEPTION TO THE EXPOSED PAD.

Figure 49. 16-Lead Lead Frame Chip Scale Package [LFCSPP]
 4 mm x 4 mm Body and 0.75 mm Package Height
 (CP-16-20)

Dimensions shown in millimeters

ORDERING GUIDE

| Model ¹ | Temperature Range | Package Description | Package Option |
|--------------------|-------------------|---------------------|----------------|
| AD8557ACPZ-R2 | –40°C to +125°C | 16-Lead LFCSP | CP-16-20 |
| AD8557ACPZ-REEL | –40°C to +125°C | 16-Lead LFCSP | CP-16-20 |
| AD8557ACPZ-REEL7 | –40°C to +125°C | 16-Lead LFCSP | CP-16-20 |
| AD8557ARZ | –40°C to +125°C | 8-Lead SOIC_N | R-8 |
| AD8557ARZ-REEL | –40°C to +125°C | 8-Lead SOIC_N | R-8 |
| AD8557ARZ-REEL7 | –40°C to +125°C | 8-Lead SOIC_N | R-8 |

¹ Z = RoHS Compliant Part.

AUTOMOTIVE PRODUCTS

The [AD8557](#) models are available with controlled manufacturing to support the quality and reliability requirements of automotive applications. Note that these automotive models may have specifications that differ from the commercial models; therefore, designers should review the Specifications section of this data sheet carefully. Only the automotive grade products shown are available for use in automotive applications. Contact your local Analog Devices account representative for specific product ordering information and to obtain the specific Automotive Reliability reports for these models.

NOTES

NOTES

Mouser Electronics

Authorized Distributor

Click to View Pricing, Inventory, Delivery & Lifecycle Information:

[Analog Devices Inc.:](#)

[AD8557ARZ](#) [AD8557ACPZ-R2](#) [AD8557ACPZ-REEL](#) [AD8557ACPZ-REEL7](#) [AD8557ARZ-REEL](#) [AD8557ARZ-REEL7](#)