

High Frequency Ceramic Solutions

Ultra Miniature 2.45GHz Impedance Matched FCC / ETSI Low Pass Filter for Nordic Semiconductor Chipsets nRF52832 , nRF52810 , nRF52811 (QFN48 & QFN32 packages)

P/N 2450FM07A0029

Detail Specification: 5/15/2019

Page 1 of 4

General Specifications

Part Number	2450FM07A0029
Frequency (MHz)	2400 - 2500
Insertion loss (dB)	0.8 max.
Return Loss (dB)	10 min.
Input Impedance (Terminal Towards Chipset)	Impedance matched to nRF52832-QFAA, -QFAB nRF52810-QFAA, -QCAA nRF52811-QFAA, -QCAA
Output Impedance	50Ω
Power Capacity	2W max. (CW)
Attenuation (dB)	
4800~5000MHz	23 typ. (20 min.)
7200~7500MHz	12 typ. (18 min.)

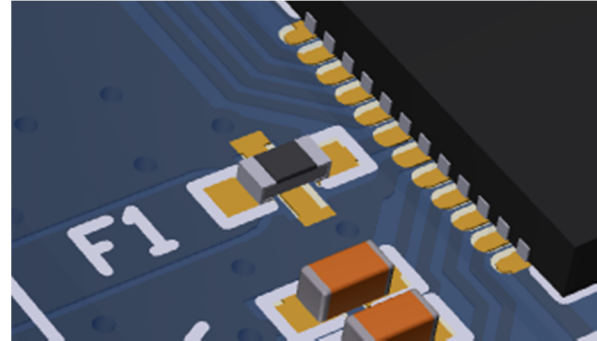

Reel Quantity	10,000 pcs
Operating Temperature	-40 to +85°C
Recommended Storage Conditions for unused T&R product	+5 to +35°C Humidity 45-75%RH 18 mo. max.

Part Number Explanation

P/N Suffix	Packaging Style	Bulk	Suffix = S	e.g. 2450FM07A0029S
		T & R	Suffix = T	e.g. 2450FM07A0029T
	Termination Style	100% Tin	Suffix = None	e.g. 2450FM07A0029(T or S)

For the Full App Note and Layout Files, go to: <https://www.johansontechnology.com/nordic>

Mechanical Dimensions

	In	mm
L	0.039 ± 0.002	1.00 ± 0.05
W	0.020 ± 0.002	0.50 ± 0.05
T	0.016 max.	0.40 max.
a	0.007 ± 0.004	0.18 ± 0.10
b	0.010 ± 0.004	0.25 ± 0.10

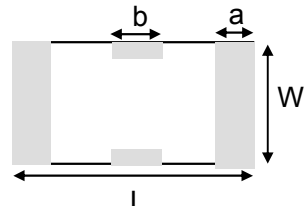
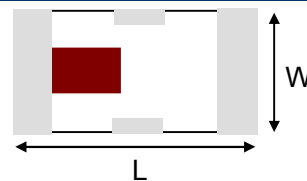
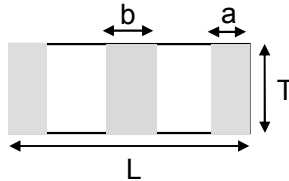

Terminal Configuration

No.	Function
1	IN (To RFIC)
2	GND
3	OUT (To Antenna)
4	GND

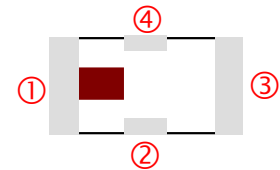

Johanson Technology, Inc. reserves the right to make design changes without notice.

All sales are subject to Johanson Technology, Inc. terms and conditions.



<https://www.johansontechnology.com>

4001 Calle Tecate • Camarillo, CA 93012, USA • TEL +1.805.389.1166

Ver. 1.4

2019 Johanson Technology, Inc. All Rights Reserved

High Frequency Ceramic Solutions

Ultra Miniature 2.45GHz Impedance Matched FCC / ETSI Low Pass Filter for Nordic Semiconductor Chipsets nRF52832 , nRF52810 , nRF52811 (QFN48 & QFN32 packages)



P/N 2450FM07A0029

Detail Specification: 5/15/2019

Page 2 of 4

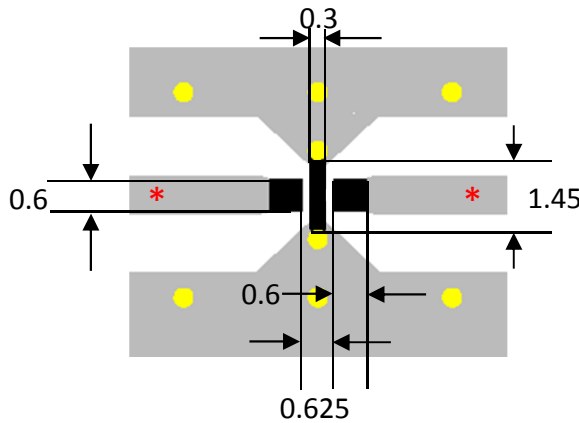
Mounting Pad Dimensions



-  Solder Resist
-  Land
-  Through-hole (ϕ 0.35)

*Line width should be designed to match 50 Ω characteristic impedance, depending on PCB material and thickness.

Do you need the layout files of the above? Go to: <https://www.johansontechnology.com/nordic> or send us a message to review your layout at: <https://www.johansontechnology.com/ask-a-question>

Measurement Schematic

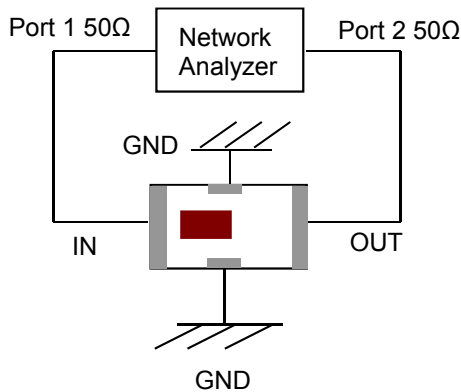

Port 1: Filter IN (marking side)
Port 2: Filter OUT

Johanson Technology, Inc. reserves the right to make design changes without notice.

All sales are subject to Johanson Technology, Inc. terms and conditions.



Ver. 1.4

<https://www.johansontechnology.com>

4001 Calle Tecate • Camarillo, CA 93012, USA • TEL +1.805.389.1166

2019 Johanson Technology, Inc. All Rights Reserved

High Frequency Ceramic Solutions

Ultra Miniature 2.45GHz Impedance Matched FCC / ETSI Low Pass Filter for Nordic Semiconductor Chipsets nRF52832 , nRF52810 , nRF52811 (QFN48 & QFN32 packages)

P/N 2450FM07A0029

Detail Specification: 5/15/2019

Page 3 of 4

Typical Electrical Characteristics (T=25°C)

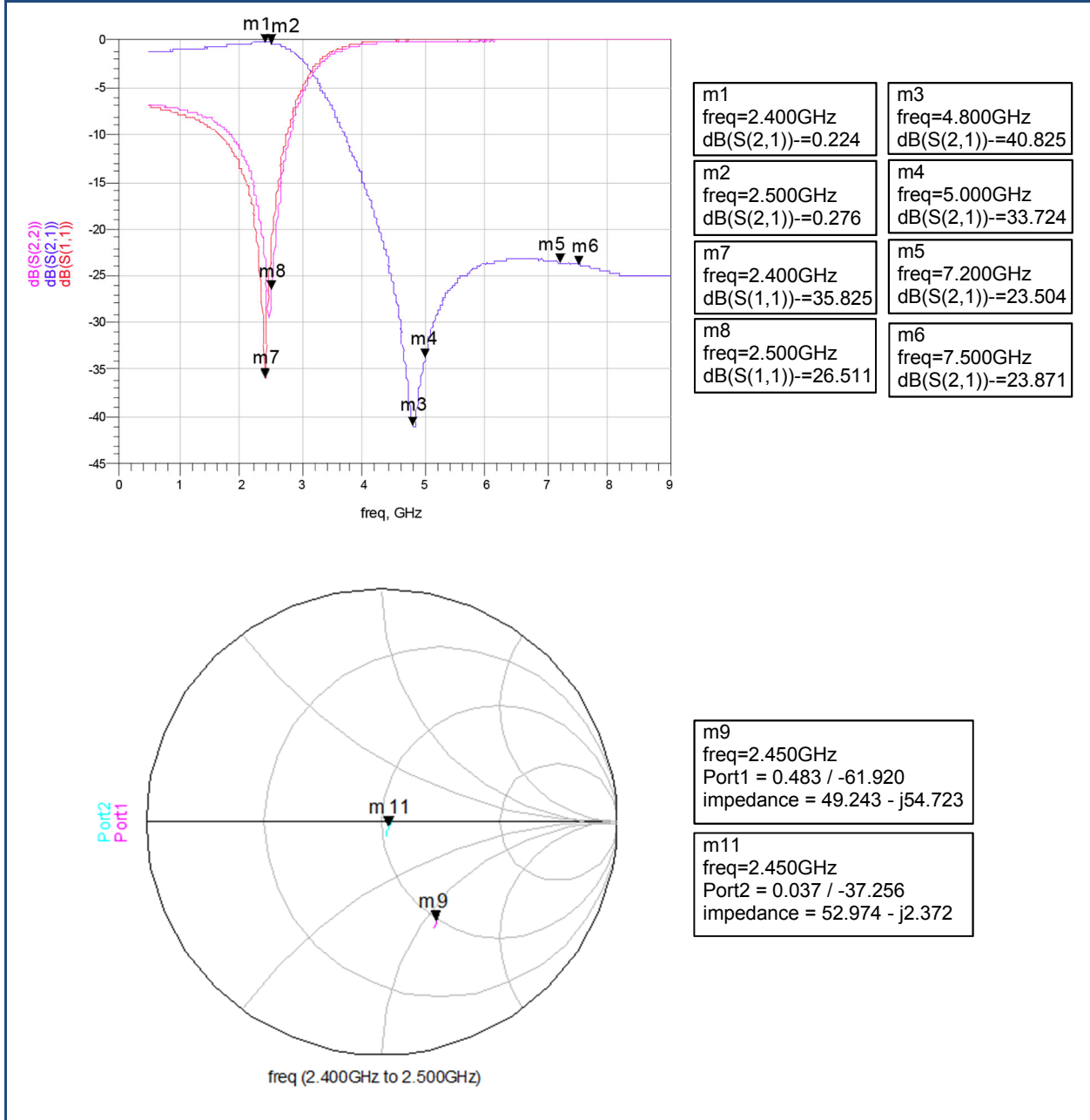

Johanson Technology, Inc. reserves the right to make design changes without notice.

All sales are subject to Johanson Technology, Inc. terms and conditions.



<https://www.johansontech.com>

4001 Calle Tecate • Camarillo, CA 93012, USA • TEL +1.805.389.1166

Ver. 1.4

2019 Johanson Technology, Inc. All Rights Reserved

High Frequency Ceramic Solutions

Ultra Miniature 2.45GHz Impedance Matched FCC / ETSI Low Pass Filter for Nordic Semiconductor Chipsets nRF52832 , nRF52810 , nRF52811 (QFN48 & QFN32 packages)

P/N 2450FM07A0029

Detail Specification: 5/15/2019

Page 4 of 4

Application Notes, Layout Files, and more

<https://www.johansontechnology.com/nordic>

Packaging information

<https://www.johansontechnology.com/tape-reel-packaging>

Soldering Information

<https://www.johansontechnology.com/ipcsoldering-profile>

MSL Info

<https://www.johansontechnology.com/msl-rating>

Recommended Storage Condition and Max Shelf Life

<https://www.johansontechnology.com/recommended-storage-conditions>

RoHS Compliance

<https://www.johansontechnology.com/technical-notes/rohs-compliance>

Antenna layout and tuning techniques

<https://www.johansontechnology.com/tuning>

Antenna layout review, tuning, and characterization services

<https://www.johansontechnology.com/ipc-antenna-services>

Johanson uses 6/6 RoHS Green Low-Temperature-Co-fired-Ceramic (LTCC) integrated passive technology in a 4-pin (Sn plated) monolithic structure. This component is 100% RF Tested, making it a more reliable system, impedance controlled environment, consistent-guaranteed RF performance in a very small RF front end-solution compared to the L/C discrete solution.

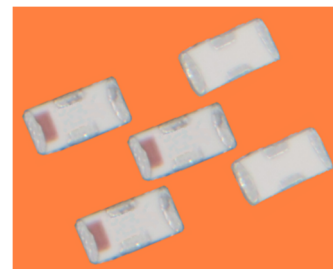

Johanson Technology, Inc. reserves the right to make design changes without notice.

All sales are subject to Johanson Technology, Inc. terms and conditions.



Ver. 1.4

<https://www.johansontechnology.com>

4001 Calle Tecate • Camarillo, CA 93012, USA • TEL +1.805.389.1166

2019 Johanson Technology, Inc. All Rights Reserved

Mouser Electronics

Authorized Distributor

Click to View Pricing, Inventory, Delivery & Lifecycle Information:

[Johanson:](#)

[2450FM07A0029T](#)