

## Round cylinders ESNU

**FESTO**



## Key features

### At a glance

ESNU-8 ... 63

- Stainless steel piston rod
- Good running performance and long service life
- Piston rod with male and female thread

ESNU-8 ... 25



- Extensive range of accessories makes it possible to install the cylinder virtually anywhere

- The basic versions conform to ISO 6432, variants are based on these standards

### Wide choice of variants

ESNU-...

- Piston  $\varnothing$  8 ... 63 mm
- Cylinder barrel made of stainless steel
- Bearing and end caps made of wrought aluminium alloy

ESNU-...-MA

- Piston  $\varnothing$  8 ... 63 mm
- Cylinder barrel made of stainless steel
- Bearing cap with threaded flange
- Short end cap with axial supply port



### Cushioning types

Cushioning P

#### Mode of operation

- The drive is equipped with flexible polymer end-position cushioning





#### Application

- Small loads
- Low speeds
- Low impact energies

#### Advantages

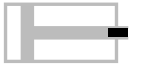
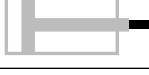
- No adjustment required
- Saves time

## Key features

Further variants Symbol	Key features	Description
	K2 Extended male piston rod thread	–
	K3 Female piston rod thread	–
	K5 Custom piston rod thread	Metric standard thread to ISO
	K6 Shortened male piston rod thread	–
	K8 Extended piston rod	–
	A6 Metal scraper (32 ... 63 mm)	The cylinder has a hard-chrome-plated piston rod and metal scraper, which scrapes off hard particles (e.g. welding spatter) that stick to the piston rod. For use in welding systems, for example

## Longer service life with bellows kit DADB



The bellows protects the piston rod, the seal and the bearing from the effects of a wide range of media, which has a positive impact on the service life of these components.

The bellows kit is a leak-free system. To prevent unwanted media from being drawn in, the supply and exhaust air for the kit must be ducted via a pressure compensation hole in the connection part [1].

The kit protects the piston rod, seal and bearing against a wide variety of media, for example:

- Dust
- Chippings
- Oil
- Grease
- Fuel

Product range overview

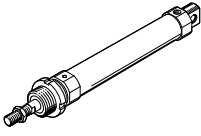
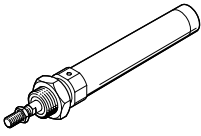
Function	Design	Piston $\varnothing$	Stroke	Variable stroke <sup>1)</sup>	Cushioning Fixed	Position sensing
		[mm]	[mm]	[mm]	P	A
Single-acting	<b>ESNU-... – With position sensing</b>					
		8 ... 63	10, 25, 50	1 ... 50	■	■
Single-acting	<b>ESNU-MA-... – Axial supply port</b>					
		8 ... 63	–	1 ... 50	■	■

1) Cylinders with position sensing require a minimum stroke of 10 mm to ensure reliable sensing

Product range overview

Piston $\varnothing$	Piston rod					→ Page/ Internet
	Extended K8	Male thread			Female thread K3	
		Extended K2	Shortened K6	Custom thread K5		
<b>ESNU-... – With position sensing</b>						
8 ... 63	■	■	■	■	■	9
<b>ESNU-MA-... – Axial supply port</b>						
8 ... 63	■	■	■	■	■	9

Peripherals overview

ESNU-...

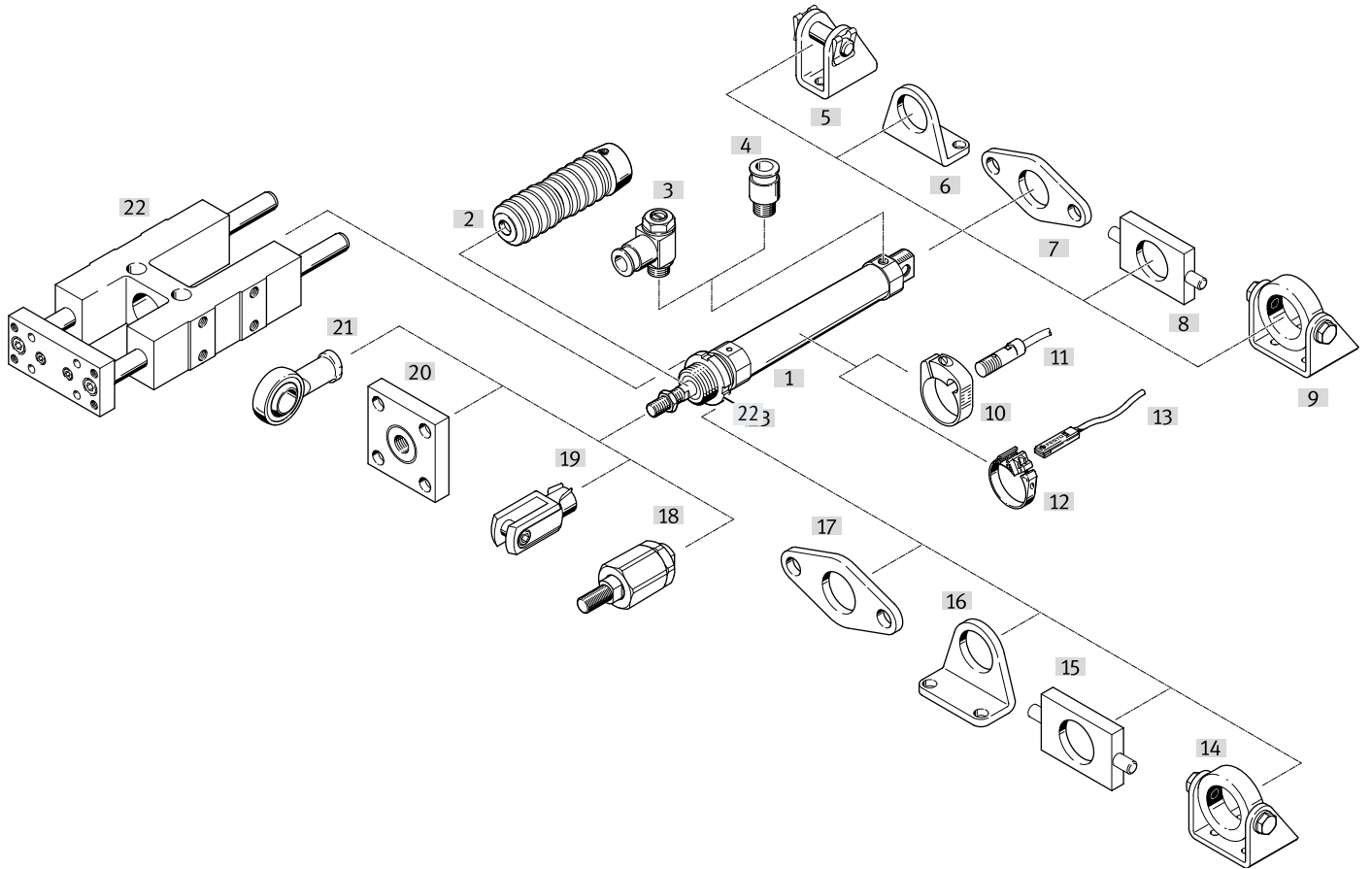

## Peripherals overview

Mounting attachments and accessories		Piston ø	ESNU	MA	→ Page/ Internet
[1]	Round cylinder ESNU				
[2]	Bellows kit <sup>2)</sup> DADB	12 ... 63	■	■	28
[3]	One-way flow control valve GRLZ	8 ... 63	■	■	33
[4]	Push-in fitting QS	8 ... 63	■	■	qs
[5]	Clevis foot LBN/CRLBN	8 ... 63	■	—	25
[6]	Foot mounting HBN/CRHBN/CRH	8 ... 63	■	■	20
[7]	Flange mounting FBN/CRFBN/CRFV	8 ... 63	■	■	22
[8]	Swivel mounting <sup>1)</sup> WBN	8 ... 63	■	■	24
[9]	Swivel mounting <sup>1)</sup> SBN	20 ... 63	■	■	24
[10]	Mounting kit SMBR/CRSMBR	8 ... 63	■	■	31
[11]	Proximity switch SMEO/SMTO/CRSMEO-4	8 ... 63	■	■	31
[12]	Mounting kit SMBR-8	12 ... 63	■	■	32
[13]	Proximity switch SME/SMT-8	8 ... 63	■	■	32
[14]	Self-aligning rod coupler FK/CRFK	8 ... 63	■	■	26
[15]	Rod clevis SG/CRSG	8 ... 63	■	■	26
[16]	Coupling piece KSG/KSZ	12 ... 63	■	■	26
[17]	Rod eye SGS/CRSGS	8 ... 63	■	■	26
[18]	Guide unit FEN	8 ... 25	■	■	27
[19]	Right-angle clevis foot LQG	32 ... 63	■	■	25
[20]	Rod clevis SGA	32 ... 63	■	■	26
[21]	Clevis foot LBG	32 ... 63	■	■	25
[22]	Hex nut MSK	16 ... 25	■	■	26

 **Note**

- 1) Cannot be used on the bearing cap in combination with bellows kit DADB.
- 2) The bellows kit protects the cylinder (piston rod, seal and bearings) against a wide range of media and thus prevents premature wear. It can only be used in combination with an extended piston rod (K8)

## Type codes

### ESNU-...

<b>001</b>	<b>Series</b>	
<b>ESNU</b>	Round cylinder, single-acting, pressing, based on ISO 6432	

<b>002</b>	<b>Piston diameter</b>	
<b>8</b>	8	
<b>10</b>	10	
<b>12</b>	12	
<b>16</b>	16	
<b>20</b>	20	
<b>25</b>	25	
<b>32</b>	32	
<b>40</b>	40	
<b>50</b>	50	
<b>63</b>	63	

<b>003</b>	<b>Stroke</b>	
<b>...</b>	1 ... 50	

<b>004</b>	<b>Cushioning</b>	
<b>P</b>	Elastic cushioning rings/plates on both sides	

<b>005</b>	<b>Position sensing</b>	
<b>A</b>	For proximity sensor	

<b>006</b>	<b>End cap</b>	
	Standard	
<b>MA</b>	Axial supply port	

<b>007</b>	<b>Piston rod thread extension</b>	
	None	
<b>K2</b>	1 ... 35 mm	

<b>008</b>	<b>K6 - Shortened male piston rod thread</b>	
	None	
<b>K6</b>	1 ... 10 mm	

<b>009</b>	<b>Piston rod thread type</b>	
	Male thread	
<b>K3</b>	Female thread	

<b>010</b>	<b>Custom thread</b>	
<b>"M10"K5</b>	M10	
<b>"M12"K5</b>	M12	
<b>"M16"K5</b>	M16	

<b>011</b>	<b>Piston rod extension</b>	
	None	
<b>...K8</b>	1 ... 50 mm	



## Datasheet

## P cushioning

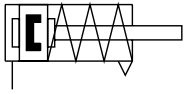

-  $\varnothing$  - Diameter  
 8 ... 25 mm  
 ISO 6432

-  $\varnothing$  - Diameter  
 32 ... 63 mm

- | - Stroke length  
 1 ... 50 mm

**General technical data**

Piston $\varnothing$	8	10	12	16	20	25	32	40	50	63
Conforms to standard	ISO 6432						-			
Pneumatic connection	M5	M5	M5	M5	G1/8	G1/8	G1/8	G1/4	G1/4	G3/8
Piston rod thread	M4	M4	M6	M6	M8	M10x1.25	M10x1.25	M12x1.25	M16x1.5	M16x1.5
Stroke <sup>1)</sup>	[mm] 1 ... 50									
Design	Piston/piston rod/cylinder barrel									
Cushioning	Elastic cushioning rings/pads at both ends									
Position sensing	Via proximity switch									
Type of mounting	With accessories									
Mounting position	Any									

1) Cylinders with position sensing require a minimum stroke of 10 mm to ensure reliable sensing

**Operating and environmental conditions**

	8	10	12	16	20	25	32	40	50	63
Operating medium	Compressed air to ISO 8573-1:2010 [7:4:4]									
Note on the operating/ pilot medium	Lubricated operation possible (in which case lubricated operation will always be required)									
Operating pressure	[MPa]	0.15 ... 1			0.12 ... 1					
	[bar]	1.5 ... 10			1.2 ... 10					
Ambient temperature <sup>1)</sup>	[°C]	-20 ... +80								
Corrosion resistance class CRC <sup>2)</sup>	2									

1) Note operating range of proximity switches

2) Corrosion resistance class CRC 2 to Festo standard FN 940070

Moderate corrosion stress. Indoor applications in which condensation can occur. External visible parts with primarily decorative surface requirements which are in direct contact with a normal industrial environment.

## Datasheet

Forces [N] and impact energy [J]										
Piston ø	8	10	12	16	20	25	32	40	50	63
Theoretical force at 0.6 MPa (6 bar), advancing	24	41	61	107	169	270	442	688	1071	1763
Theoretical spring return force										
Stroke 10 mm	4.9	4.9	6.3	13.2	18.3	22.9	36	60	95	95
Stroke 25 mm	4.1	4.1	5.4	11.9	16.5	21.2	30	50	82	82
Stroke 50 mm	2.8	4.8	3.9	9.8	13.6	18.5	20	30	60	60
Impact energy in the end positions <sup>1)</sup>	0.03	0.05	0.07	0.15	0.20	0.30	0.40	0.70	1	1.3

1) The values are reduced by approx. 50% at ambient temperatures of 80°C

Weight ESNU-... [g]										
Piston ø	8	10	12	16	20	25	32	40	50	63
Product weight with 0 mm stroke	35	37.3	75	89.9	186.8	238	370.5	661	1087	1445
Additional weight per 10 mm stroke	2.4	2.7	4	4.6	7.2	11	15.5	24	40	44

Weight ESNU-...-MA [g]										
Piston ø	8	10	12	16	20	25	32	40	50	63
Product weight with 0 mm stroke	30	33	65	81	167	222	330	585	1013	1369
Additional weight per 10 mm stroke	2.4	2.7	4	4.6	7.2	11	15.5	24	40	44

### Materials

#### Sectional view

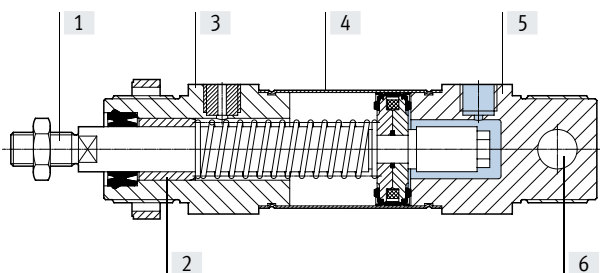

Round cylinder		
[1]	Piston rod	High-alloy steel
[2]	Piston rod bearing	Sintered bronze
[3]	Bearing cap	Anodised aluminium
[4]	Cylinder barrel	High-alloy stainless steel
[5]	End cap	Anodised aluminium
-	Seals	NBR, TPE-U(PU)
-	Spring	Spring steel
	PWIS conformity	VDMA24364-B1/B2-L
	Note on materials	RoHS-compliant
[6]	Swivel bearing	Polymer

Datasheet

Dimensions

Download CAD data → [www.festo.com](http://www.festo.com)

ESNU-8 ... 25

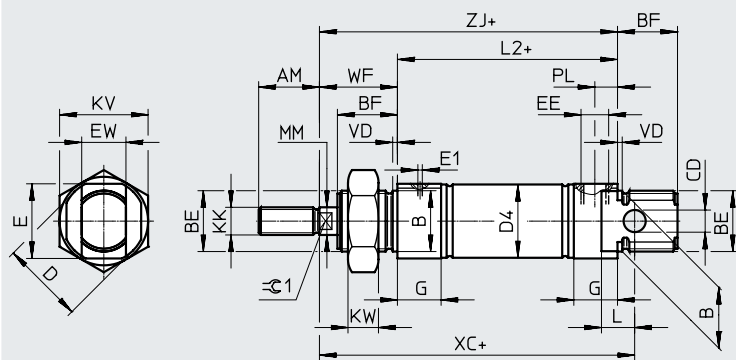

MA – Axial supply port

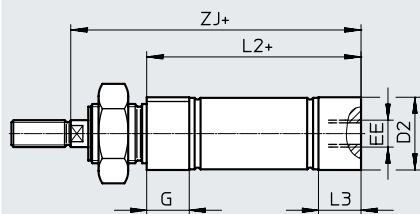

Note

Piston rod nut is not included in the scope of delivery for diameter 8 ... 20.  
+ = plus stroke length

∅ [mm]	AM	B ∅ h8	BE	BF	CD ∅ H9	D ∅	D2 ∅	D4 ∅	E	E1	EE	EW	G	KK
							-MA							
8	12	12	M12x1.25	12	2	16	10.5	9.3	14	1	M5	8	10	M4
10							12.5							
12	16	16	M16x1.5	17	3	20	14.5	13.3	18	1.6	G1/8	12	16	M6
16							17.5							
20	20	22	M22x1.5	20	4	30	21.7	21.3	26	2	G1/8	16	16	M8
25							26.7							
25	22			22			26.5		27					M10x1.25

∅ [mm]	KV	KW	MM ∅	L	L2			L3	PL	VD	WF ±1.2	XC ±1	ZJ		≈G1
					ESNU- ...	-MA	-MA						ESNU- ...	-MA	
8	19	6	4	6	46	43.6	7.6	6	6	2	16	64	62	59.6	-
10						43.1	7.1						59.1		
12	24	8	6	9	50	47.7	7.7	8.2	8.2	2	22	75	72	69.7	5
16						53.7	7.7						78	75.7	
20	32	11	8	12	68	66.5	14.5	8.2	8.2	2	24	95	92	90.5	7
25			10		69.5	68.5	14				28	104	97.5	96.5	9

Datasheet

Dimensions

Download CAD data → [www.festo.com](http://www.festo.com)

ESNU-8 ... 25

K2 – Extended male piston rod thread

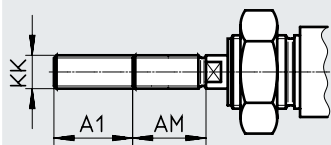

K6 – Shortened male piston rod thread

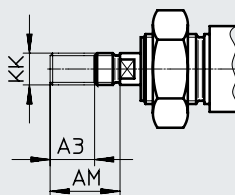

K3 – Female piston rod thread

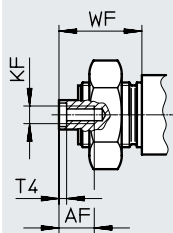

K5 – Custom piston rod thread

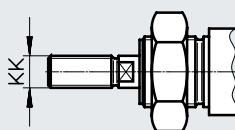

K8 – Extended piston rod

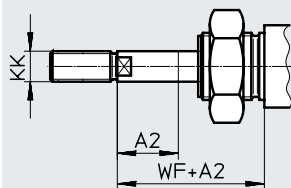

∅ [mm]	A1 max.	A2 max.	A3 max.	AF	AM	KF	KK		T4	WF ±1.2
							Basic thread	Custom thread <sup>1)</sup>		
8	15	50	4	-	12	-	M4	-	-	16
10				-		-		-		
12				-		-		-		
16	20		8	12	-	16	-	M6	-	22
20					-		20		M4	
25	35			-	-	22	M6	M10x1.25	M10	2.6

1) The custom threads are only available as male threads. The scope of delivery does not include a hex nut for the piston rod thread

Datasheet

Dimensions

Download CAD data → [www.festo.com](http://www.festo.com)

ESNU-32 ... 63

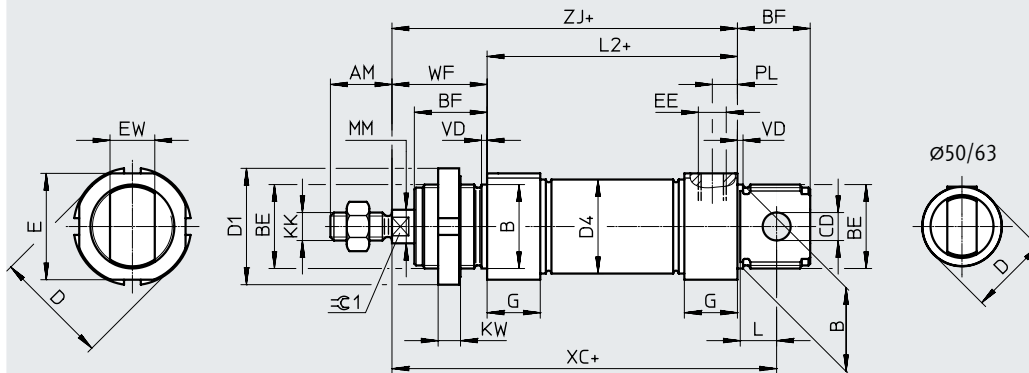

MA – Axial supply port

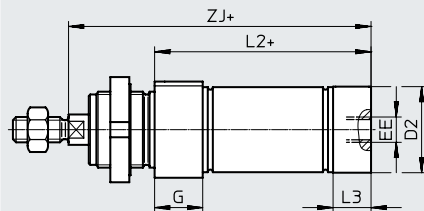

+ = plus stroke length

∅	AM	B ∅ h8	BE	BF	CD ∅ H9	D ∅	D1 ∅	D2 ∅	D4 ∅	E	EE	EW	G	KK
32	22	30	M30x1.5	26	10	41	42	34	33.6	38	G1/8	16	19	M10x1.25
40	24	38	M38x1.5	30	12	49	50	42	41.6	45	G1/4	18	25	M12x1.25
50	32	45	M45x1.5	33	16	57	60	53	52.4	–		G3/8	21	28
63						70		66	65.4	–				

∅	KW	L	L2		L3	PL	MM ∅	VD	WF ±1.2	XC ±1	ZJ		≈C1
			ESNU- ...	-MA							ESNU- ...	-MA	
32	8	13	69.5	65.5	15	9	12	2	34	117.5	103.5	99.5	10
40			84.6	77.6							18	12	
50		16	86.2	86.2	25	20	3		44	147.2	130.2		130.2
63			94.2	94.2	28				13	45	156.2	139.2	139.2

## Datasheet

### Dimensions

Download CAD data → [www.festo.com](http://www.festo.com)

ESNU-32 ... 63

K2 – Extended male piston rod thread

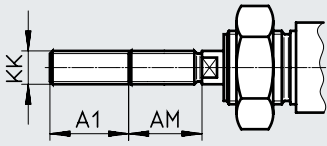

K6 – Shortened male piston rod thread

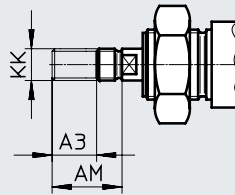

K3 – Female piston rod thread

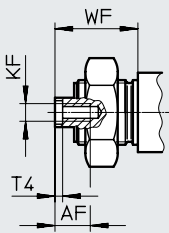

K5 – Custom piston rod thread

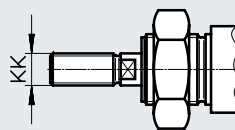

K8 – Extended piston rod

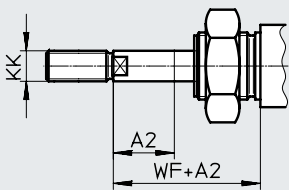

∅ [mm]	A1 max.	A2 max.	A3 max.	AF	AM	KF	KK		T4	WF ±1.2
							Basic thread	Custom thread <sup>1)</sup>		
32	35	50	8	12	22	M6	M10x1.25	M10	2.6	34
40							M12x1.25	M12	3.3	39
50			10	16	32	M10	M16x1.5	M16	4.7	44
63										45

1) The custom threads are only available as male threads. The scope of delivery does not include a hex nut for the piston rod thread

## Datasheet

Ordering data			
Piston ø [mm]	Stroke [mm]	Part no.	Type
8	10	19254	ESNU-8-10-P-A
	25	19255	ESNU-8-25-P-A
	50	19256	ESNU-8-50-P-A
10	10	19257	ESNU-10-10-P-A
	25	19258	ESNU-10-25-P-A
	50	19259	ESNU-10-50-P-A
12	10	19260	ESNU-12-10-P-A
	25	19261	ESNU-12-25-P-A
	50	19262	ESNU-12-50-P-A
16	10	19263	ESNU-16-10-P-A
	25	19264	ESNU-16-25-P-A
	50	19265	ESNU-16-50-P-A
20	10	19266	ESNU-20-10-P-A
	25	19267	ESNU-20-25-P-A
	50	19268	ESNU-20-50-P-A
25	10	19269	ESNU-25-10-P-A
	25	19270	ESNU-25-25-P-A
	50	19271	ESNU-25-50-P-A
32	10	196376	ESNU-32-10-P-A
	25	196377	ESNU-32-25-P-A
	50	196378	ESNU-32-50-P-A
40	10	196379	ESNU-40-10-P-A
	25	196380	ESNU-40-25-P-A
	50	196381	ESNU-40-50-P-A
50	10	196382	ESNU-50-10-P-A
	25	196383	ESNU-50-25-P-A
	50	196384	ESNU-50-50-P-A
63	10	196385	ESNU-63-10-P-A
	25	196386	ESNU-63-25-P-A
	50	196387	ESNU-63-50-P-A

Ordering data			
Piston ø [mm]	Stroke [mm]	Part no.	Type
<b>Variable stroke</b>			
8	1 ... 50	14119	ESNU-8-...-P-A
10	1 ... 50	14118	ESNU-10-...-P-A
12	1 ... 50	14317	ESNU-12-...-P-A
16	1 ... 50	14316	ESNU-16-...-P-A
20	1 ... 50	14319	ESNU-20-...-P-A
25	1 ... 50	14318	ESNU-25-...-P-A

Ordering data – Modular product system

Ordering table									
Size	8	10	12	16	20	25	Conditions	Code	Enter code
Module no.	<b>193996</b>	<b>193997</b>	<b>193998</b>	<b>193999</b>	<b>194000</b>	<b>194001</b>			
Function	Round cylinder, single-acting, pushing, based on ISO 6432							<b>ESNU</b>	ESNU
Piston Ø [mm]	8	10	12	16	20	25		-...	
Stroke [mm]	1 ... 50							-...	
Cushioning	Elastic cushioning rings/pads at both ends							<b>-P</b>	-P
Position sensing	Via proximity switch						[1]	<b>-A</b>	-A
End cap	Axial supply port							<b>-MA</b>	

[1] A Minimum stroke ≥ 10 mm required for reliable sensing



**Note**

Cylinders with position sensing require a minimum stroke of 10 mm to ensure reliable sensing.

Longer strokes on request



## Ordering data – Modular product system

Ordering table		8	10	12	16	20	25	Conditions	Code	Enter code	
Extended male thread		Extended male piston rod thread									
	[mm]	1 ... 15	1 ... 20	1 ... 25	1 ... 35	[2]		-...K2			
Shortened male thread		Shortened male piston rod thread									
	[mm]	1 ... 4	1 ... 8					-...K6			
Female thread		Piston rod with female thread									
		-	-	-	-	(M4)	(M6)	[3]	-K3		
Custom thread		Custom thread on the piston rod									
		-	-	-	-	-	M10		-"...K5		
Extended piston rod		Extended piston rod									
	[mm]	1 ... 50						...K8			

[2] K2 Not with female thread K3, shortened male thread K6

[3] K3 Not with custom thread K5, shortened male thread K6

Ordering data – Modular product system

Ordering table							
Size	32	40	50	63	Conditions	Code	Enter code
Module no.	<b>194002</b>	<b>194003</b>	<b>194004</b>	<b>194005</b>			
Function	Single-acting round cylinder					<b>ESNU</b>	ESNU
Piston Ø [mm]	32	40	50	63		-...	
Stroke [mm]	1 ... 50					-...	
Cushioning	Elastic cushioning rings/pads at both ends					<b>-P</b>	-P
Position sensing	Via proximity switch				[1]	<b>-A</b>	-A
End cap	Axial supply port					<b>-MA</b>	

[1] A Minimum stroke ≥ 10 mm required for reliable sensing



**Note**

Cylinders with position sensing require a minimum stroke of 10 mm to ensure reliable sensing.  
Longer strokes on request

## Ordering data – Modular product system

Ordering table							
Size	32	40	50	63	Conditions	Code	Enter code
Extended male thread	Extended male piston rod thread						
	[mm]	1 ... 35			[2]	-...K2	
Shortened male thread	Shortened male piston rod thread						
	[mm]	1 ... 8		1 ... 10		-...K6	
Female thread	Piston rod with female thread						
		(M6)	(M8)	(M10)	[3]	-K3	
Custom thread	Custom thread on the piston rod						
		M10	M12	M16		-“...”K5	
Extended piston rod	Extended piston rod						
	[mm]	1 ... 50				...K8	

[2] K2 Not with female thread K3, shortened male thread K6

[3] K3 Not with custom thread K5, shortened male thread K6

## Accessories

### Foot mounting HBN/CRHBN

Scope of delivery:

HBN/CRHBN-...x1: 1 foot

HBN/CRHBN-...x2: 2 feet and 1 nut

Material:

HBN: Galvanised steel

CRHBN: High-alloy stainless steel

Free of copper and PTFE

RoHS-compliant

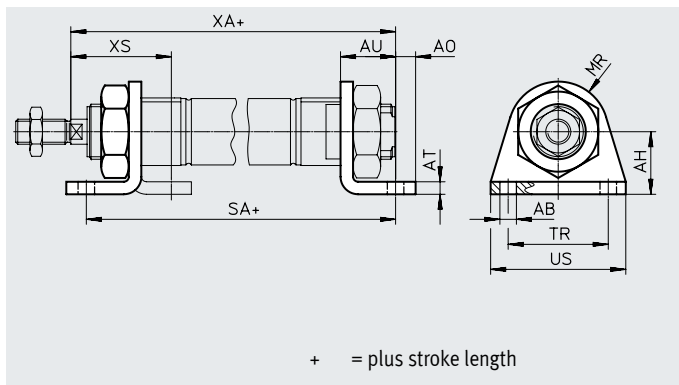

#### Dimensions and ordering data

For $\varnothing$ [mm]	AB $\varnothing$	AH	AO	AT	AU	R1	SA	TR	US	XA	XS
8, 10	4.5	16	5	3	11	10	68	25	35	73	24
12	5.5	20	6	4	14	13	78	32	42	86	32
16	5.5	20	6	4	14	13	84	32	42	92	32
20	6.6	25	8	5	17	20	102	40	54	109	36
25	6.6	25	8	5	17	20	103.5	40	54	114.5	40

For $\varnothing$ [mm]	Basic version				High corrosion protection			
	CRC <sup>1)</sup>	Weight [g]	Part no.	Type	CRC <sup>1)</sup>	Weight [g]	Part no.	Type
8, 10	1	22	5123	HBN-8/10x1	-	-	-	
	1	54	5124	HBN-8/10x2	-	-	-	
12, 16	1	43	5125	HBN-12/16x1	4	43	161866	CRHBN-12/16x1
	1	107	5126	HBN-12/16x2	4	107	162999	CRHBN-12/16x2
20, 25	1	95	5127	HBN-20/25x1	4	94	161867	CRHBN-20/25x1
	1	237	5128	HBN-20/25x2	4	236	162998	CRHBN-20/25x2

1) Corrosion resistance class CRC 1 to Festo standard FN 940070

Low corrosion stress. Dry internal application or transport and storage protection. Also applies to parts behind covers, in the non-visible interior area, or parts which are covered in the application (e.g. drive trunnions).

Corrosion resistance class CRC 4 to Festo standard FN 940070

Particularly high corrosion stress. Outdoor exposure under extreme corrosive conditions. Parts exposed to aggressive media, e.g. in the chemical or food industries. Such applications may need to be safeguarded by means of special testing (→ also FN 940082), using appropriate media.

## Accessories

### Foot mounting HBN/CRH

Material:

HBN: Galvanised steel

CRH: High-alloy stainless steel

Free of copper and PTFE

RoHS-compliant

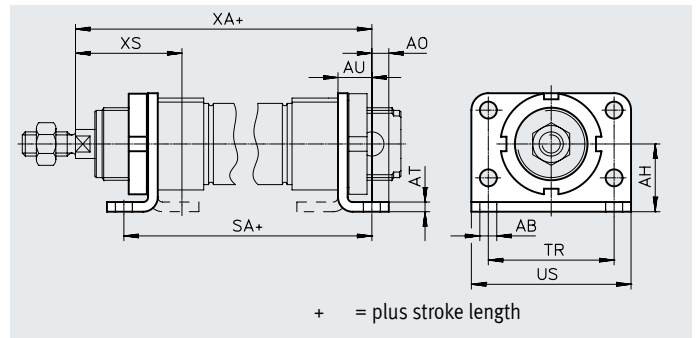

#### Dimensions and ordering data

For $\varnothing$ [mm]	AB $\varnothing$	AH	AO	AT	AU	SA	TR	US	XA	XS
32	7	28	7	4	14	97.5	52	66	117.5	44
40	9	33	10	5	20	124.6	60	80	143.6	54
50	9	40	10	6	20	126.2	70	90	150.2	58
63	9	45	10	6	20	134.2	76	96	159.2	59

For $\varnothing$ [mm]	Basic version				High corrosion protection			
	CRC <sup>1)</sup>	Weight [g]	Part no.	Type	CRC <sup>1)</sup>	Weight [g]	Part no.	Type
32	1	353	195851	HBN-32x2	4	353	162951	CRH-32
40	1	611	195852	HBN-40x2	4	611	162952	CRH-40
50	1	916	195853	HBN-50x2	4	916	162953	CRH-50
63	1	1066	195854	HBN-63x2	4	1066	162954	CRH-63

1) Corrosion resistance class CRC 1 to Festo standard FN 940070

Low corrosion stress. Dry internal application or transport and storage protection. Also applies to parts behind covers, in the non-visible interior area, or parts which are covered in the application (e.g. drive trunnions).

Corrosion resistance class CRC 4 to Festo standard FN 940070

Particularly high corrosion stress. Outdoor exposure under extreme corrosive conditions. Parts exposed to aggressive media, e.g. in the chemical or food industries. Such applications may need to be safeguarded by means of special testing (→ also FN 940082), using appropriate media.

## Accessories

### Flange mounting FBN/CRFBN

Material:

FBN: Galvanised steel

CRFBN: High-alloy stainless steel

Free of copper and PTFE

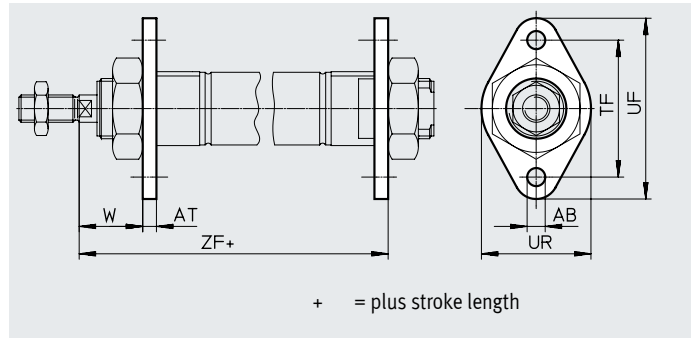

#### Dimensions and ordering data

For $\varnothing$ [mm]	AB $\varnothing$	AT	TF	UF	UR	W	ZF
8, 10	4.5	3	30	40	25	13	65
12	5.5	4	40	53	30	18	76
16	5.5	4	40	53	30	18	82
20	6.6	5	50	66	40	19	97
25	6.6	5	50	66	40	23	102.5

For $\varnothing$ [mm]	Basic version			High corrosion protection				
	CRC <sup>1)</sup>	Weight [g]	Part no.	Type	CRC <sup>1)</sup>	Weight [g]	Part no.	Type
8, 10	1	12	<b>5129</b>	<b>FBN-8/10</b>	–	–	–	–
12, 16	1	26	<b>5130</b>	<b>FBN-12/16</b>	4	26	<b>161864</b>	<b>CRFBN-12/16</b>
20, 25	1	52	<b>5131</b>	<b>FBN-20/25</b>	4	52	<b>161865</b>	<b>CRFBN-20/25</b>

1) Corrosion resistance class CRC 1 to Festo standard FN 940070

Low corrosion stress. Dry internal application or transport and storage protection. Also applies to parts behind covers, in the non-visible interior area, or parts which are covered in the application (e.g. drive trunnions).

Corrosion resistance class CRC 4 to Festo standard FN 940070

Particularly high corrosion stress. Outdoor exposure under extreme corrosive conditions. Parts exposed to aggressive media, e.g. in the chemical or food industries. Such applications may need to be safeguarded by means of special testing (→ also FN 940082), using appropriate media.

## Accessories

### Flange mounting FBN/CRFV

Material:

FBN: Galvanised steel

CRFV: High-alloy stainless steel

Free of copper and PTFE

RoHS-compliant

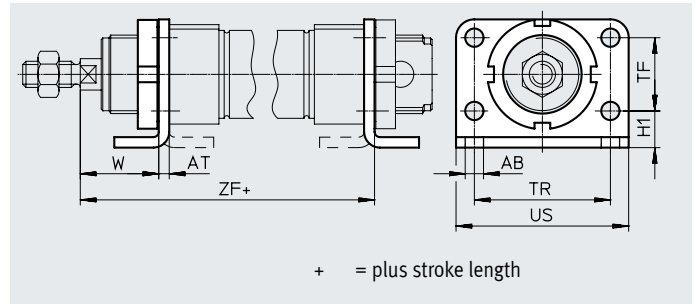

#### Dimensions and ordering data

For $\varnothing$ [mm]	AB $\varnothing$	AT	H1	TF	TR	US	W	ZF
32	7	4	14	28	52	66	30	107.5
40	9	5	18	30	60	80	29	128.6
50	9	6	20	40	70	90	38	136.2
63	9	6	20	50	76	96	39	145.2

For $\varnothing$ [mm]	Basic version				High corrosion protection			
	CRC <sup>1)</sup>	Weight [g]	Part no.	Type	CRC <sup>1)</sup>	Weight [g]	Part no.	Type
32	1	103	<b>195855</b>	<b>FBN-32</b>	4	103	<b>161858</b>	<b>CRFV-32</b>
40	1	191	<b>195856</b>	<b>FBN-40</b>	4	191	<b>161859</b>	<b>CRFV-40</b>
50	1	292	<b>195857</b>	<b>FBN-50</b>	4	292	<b>161860</b>	<b>CRFV-50</b>
63	1	367	<b>195858</b>	<b>FBN-63</b>	4	367	<b>161861</b>	<b>CRFV-63</b>

1) Corrosion resistance class CRC 1 to Festo standard FN 940070

Low corrosion stress. Dry internal application or transport and storage protection. Also applies to parts behind covers, in the non-visible interior area, or parts which are covered in the application (e.g. drive trunnions).

Corrosion resistance class CRC 4 to Festo standard FN 940070

Particularly high corrosion stress. Outdoor exposure under extreme corrosive conditions. Parts exposed to aggressive media, e.g. in the chemical or food industries. Such applications may need to be safeguarded by means of special testing (→ also FN 940082), using appropriate media.

## Accessories

### Swivel mounting SBN

Material:  
 Retaining ring: Anodised wrought aluminium alloy  
 Bearing: Bronze  
 Screws: galvanised steel  
 Bracket: Steel  
 Cannot be used on the bearing cap in combination with bellows kit DADB.

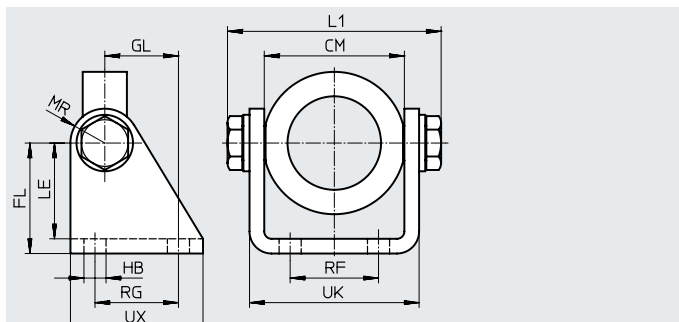
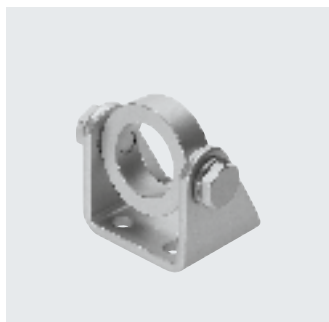

Dimensions and ordering data														Weight [g]	Part no.	Type
For $\varnothing$ [mm]	CM	FL	GL	HB	L1 max.	LE	MR	RF	RG	UK	UX	CRC <sup>1)</sup>				
20/25	38.1+0.4	35	20	7	60.2	31	12	20	24	46.1	40	1	238	539927	SBN-20/25	
32	46.1+0.2	40	27	9	72.2	35	13	28	30	56.1	50	1	361	539924	SBN-32	
40	57.1+0.2	45	30	9	88.2	39	14	36	34	69.1	54	1	593	539925	SBN-40	
50/63	70.1+0.4	50	34	9	102.2	44	16	42	35	82.1	65	1	894	539926	SBN-50/63	

1) Corrosion resistance class CRC 1 to Festo standard FN 940070  
 Low corrosion stress. Dry internal application or transport and storage protection. Also applies to parts behind covers, in the non-visible interior area, or parts which are covered in the application (e.g. drive trunnions).

### Swivel mounting WBN

Material:  
 Galvanised steel  
 Free of copper and PTFE  
 RoHS-compliant  
 Cannot be used on the bearing cap in combination with bellows kit DADB.

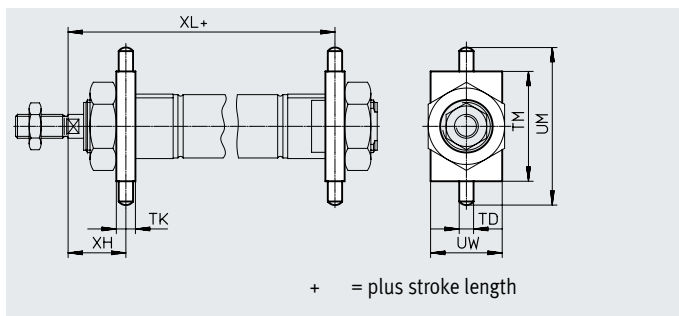

Dimensions and ordering data										Weight [g]	Part no.	Type
For $\varnothing$ [mm]	TD $\varnothing$ -0.01/-0.05	TK	TM	UM	UW	XH	XL	CRC <sup>1)</sup>				
8, 10	4	6	26	38	20	13	65	1	20	8608	WBN-8/10	
12	6	8	38	58	25	18	76	1	51	8609	WBN-12/16	
16	6	8	38	58	25	18	82	1	51	8609	WBN-12/16	
20	6	8	46	66	30	20	96	1	67	8610	WBN-20/25	
25	6	8	46	66	30	24	101.5	1	67	8610	WBN-20/25	
32	8	12	50	76	40	28	109.5	1	131	195863	WBN-32	
40	10	15	60	92	50	31.5	126.1	1	238	195864	WBN-40	
50	12	20	80	116	65	34	140.2	1	596	195865	WBN-50/63	
63	12	20	80	116	65	35	149.2	1	596	195865	WBN-50/63	

1) Corrosion resistance class CRC 1 to Festo standard FN 940070  
 Low corrosion stress. Dry internal application or transport and storage protection. Also applies to parts behind covers, in the non-visible interior area, or parts which are covered in the application (e.g. drive trunnions).



## Accessories

## Clevis foot LBN/CRLBN

Material:

LBN: galvanised steel

CRLBN: High-alloy stainless steel

Free of copper and PTFE

RoHS-compliant

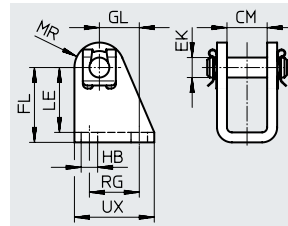

## Dimensions and ordering data

For $\varnothing$ [mm]	CM	EK $\varnothing$	FL	GL	HB	LE	MR	RG	UX
8, 10	8.1	4	24 +0.3/-0.2	13.8	4.5	21.5	5	12.5	20
12, 16	12.1	6	27 +0.3/-0.2	13	5.5	24	7	15	25
20, 25	16.1	8	30 +0.4/-0.2	16	6.6	26	10	20	32
32	16.1	10	35 +0.4/-0.2	18.5	6.6	31	11	24	35
40	18.1	12	40 +0.4/-0.2	24.5	9	35	13	30	45
50, 63	21.1	16	45 +0.5/-0.2	28	9	39	14	34	50

For $\varnothing$ [mm]	Basic version				High corrosion protection			
	CRC <sup>1)</sup>	Weight [g]	Part no.	Type	CRC <sup>1)</sup>	Weight [g]	Part no.	Type
8, 10	1	20	<b>6057</b>	<b>LBN-8/10</b>	-	-	-	
12, 16	1	40	<b>6058</b>	<b>LBN-12/16</b>	4	39	<b>161862</b>	<b>CRLBN-12/16</b>
20, 25	1	84	<b>6059</b>	<b>LBN-20/25</b>	4	82	<b>161863</b>	<b>CRLBN-20/25</b>
32	1	110	<b>195860</b>	<b>LBN-32</b>	4	106	<b>195866</b>	<b>CRLBN-32</b>
40	1	191	<b>195861</b>	<b>LBN-40</b>	4	185	<b>195867</b>	<b>CRLBN-40</b>
50, 63	1	300	<b>195862</b>	<b>LBN-50/63</b>	4	283	<b>195868</b>	<b>CRLBN-50/63</b>



1) Corrosion resistance class CRC 1 to Festo standard FN 940070

Low corrosion stress. Dry internal application or transport and storage protection. Also applies to parts behind covers, in the non-visible interior area, or parts which are covered in the application (e.g. drive trunnions).

Corrosion resistance class CRC 4 to Festo standard FN 940070

Particularly high corrosion stress. Outdoor exposure under extreme corrosive conditions. Parts exposed to aggressive media, e.g. in the chemical or food industries. Such applications may need to be safeguarded by means of special testing (→ also FN 940082), using appropriate media.

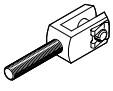
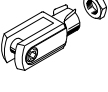
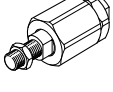
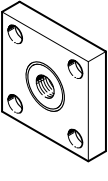
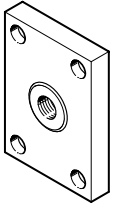
Accessories

Ordering data – Piston rod attachments				Datasheets → Internet: piston rod attachment			
Designation	For ø	Part no.	Type	Designation	For ø	Part no.	Type
<b>Rod eye SGS</b>				<b>Rod clevis SGA</b>			
	8	9253	SGS-M4		8	-	
	10						
	12	9254	SGS-M6		10		
	16						
	20	9255	SGS-M8		12		
	25						
	32	9261	SGS-M10x1.25		16		
	40						
	50	9262	SGS-M12x1.25		20		
63							
50	9263	SGS-M16x1.5	25				
63							
<b>Rod clevis SG</b>				<b>Self-aligning rod coupler FK</b>			
	8	6532	SG-M4		8	6528	FK-M4
	10						
	12	3110	SG-M6		10		
	16						
	20	3111	SG-M8		12		
	25						
	32	6144	SG-M10x1.25		16		
	40						
	50	6145	SG-M12x1.25		20		
63							
50	6146	SG-M16x1.5	25				
63							
<b>Coupling piece KSG</b>				<b>Coupling piece KSZ</b>			
	12	-			12	36123	KSZ-M6
	16						
	20						
	25	32963	KSG-M10x1.25		16		
	32						
	40	32964	KSG-M12x1.25		20		
	50						
63	32965	KSG-M16x1.5	25				
<b>Hex nut MSK</b>							
	16	189007	MSK-M16x1.5				
	20	189009	MSK-M22x1.5				
	25						

## Accessories

### Ordering data – Piston rod attachments, corrosion-resistant

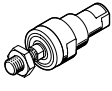
Designation	For $\varnothing$	Part no.	Type
<b>Rod eye CRSGS</b>			
	12	195580	CRSGS-M6
	16		
	20	195581	CRSGS-M8
	25	195582	CRSGS-M10x1.25
	32		
	40	195583	CRSGS-M12x1.25
	50	195584	CRSGS-M16x1.5
	63		
<b>Self-aligning rod coupler CRFK</b>			
	25	2305778	CRFK-M10x1.25
	32		
	40	2305779	CRFK-M12x1.25
	50	2490673	CRFK-M16x1.5
	63		

Datasheets → Internet: piston rod attachment

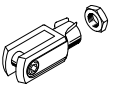
Designation	For $\varnothing$	Part no.	Type
<b>Rod clevis CRSG</b>			
	12	13567	CRSG-M6
	16		
	20	13568	CRSG-M8
	25	13569	CRSG-M10x1.25
	32		
	40	13570	CRSG-M12x1.25
	50	13571	CRSG-M16x1.5
	63		

### Ordering data – Mounting components

Designation	For $\varnothing$	Part no.	Type
<b>Clevis foot LBG</b>			
	32	31761	LBG-32
	40	31762	LBG-40
	50	31763	LBG-50
	63	31764	LBG-63

Datasheets → Internet: clevis foot

Designation	For $\varnothing$	Part no.	Type
<b>Right angle clevis foot LQG</b>			
	32	31768	LQG-32
	40	31769	LQG-40
	50	31770	LQG-50
	63	31771	LQG-63

### Ordering data – Guide units

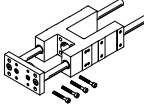
	For $\varnothing$	Stroke [mm]	With recirculating ball bearing guide		With plain-bearing guide	
			Part no.	Type	Part no.	Type
	8, 10	1 ... 100	35197	FEN-8/10-...-KF	35196	FEN-8/10-...-GF
	12, 16	1 ... 200	33481	FEN-12/16-...-KF	19168	FEN-12/16-...-GF
	20	2 ... 250	33482	FEN-20-...-KF	19169	FEN-20-...-GF
	25	2 ... 250	33483	FEN-25-...-KF	19170	FEN-25-...-GF

Datasheets → Internet: feng

## Accessories

### Bellows kit DADB



General technical data		20	25	32	40	50	63
Type DADB-S1-							
Max. stroke range of the cylinder <sup>1)2)</sup>	[mm]	10 ... 50					
Type of mounting		Via threaded pin					
Mounting position		Any					
Media resistance		Dust, chippings, oil, grease, fuel (→ Internet: media resistance)					
Ambient temperature <sup>3)</sup>	[°C]	-10 ... +80					
Corrosion resistance class CRC <sup>4)</sup>		3					

- 1) In conjunction with the bellows kit DADB
- 2) Slight change in spring return force
- 3) Note operating range of proximity switches and cylinder
- 4) Corrosion resistance class CRC 3 to Festo standard FN 940070  
High corrosion stress. Outdoor exposure under moderate corrosive conditions. Externally visible parts with primarily functional surface requirements which are in direct contact with a normal industrial environment.

### Materials

#### Sectional view

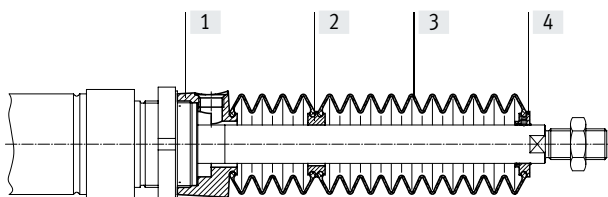

Bellows		
[1] Connection		Polyamide
[2] Adapter		Polyamide
[3] Bellows		NBR
[4] End piece		Polyamide
- O-ring		NBR
Note on materials		Free of copper and PTFE RoHS-compliant

Weights [g]		20	25	32
Type DADB-S1-	Stroke [mm]			
10 ... 50		20	19	29
Type DADB-S1-	Stroke [mm]	40	50	63
10 ... 50		34	55	55

## Accessories

### Travel speed $v$ as a function of tubing length $l$



The bellows kit is a leak-free system.

To prevent unwanted media from being drawn in, the supply and exhaust air must be ducted via a pressure compensation hole in the connection part.

The pressure generated in the bellows kit by the positioning motion is primarily defined by the travel speed and tubing length. The recommended tubing length based on the travel speed of the drive can be read from the graph.

#### Advancing

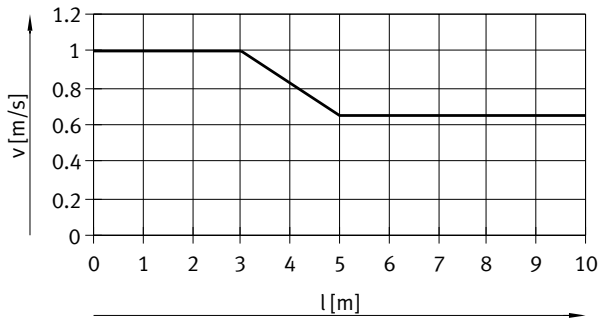

— ESNU-20/25

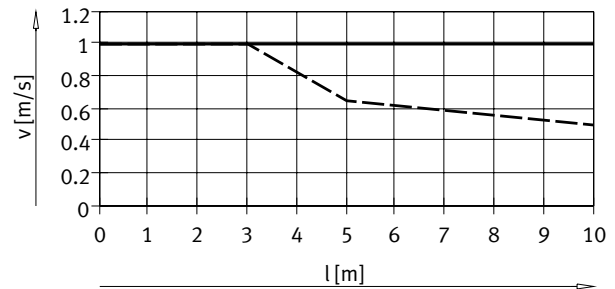

— ESNU-32/50/63  
 ..... ESNU-40

#### Retracting

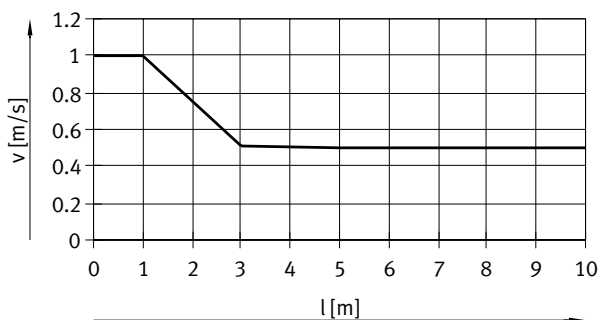

— ESNU-20/25

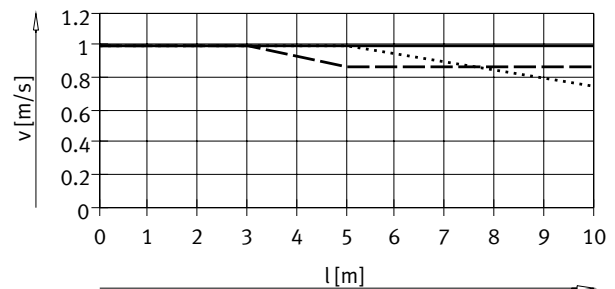

— ESNU-32  
 ..... ESNU-40  
 - - - ESNU-50/63

 Note  
 The push-in fittings in the adjacent table must be used for the pressure compensation hole. Silencers can be used as an alternative. This reduces the travel speed slightly.

Tubing size and push-in fitting for pressure compensation hole			
∅ [mm]	Tubing O.D. [mm]	Push-in fitting Part no.	Type
20, 25	6	★ 153317	QSM-M5-6-I
		578371	NPQH-DK-M5-Q6-P10
		578335	NPQH-D-M5-Q6-P10
		578359	NPQH-D-M5-S6-P10
32, 40	8	★ 186109	QS-G1/8-8-I
		578376	NPQH-DK-G18-Q8-P10
		578362	NPQH-D-G18-S8-P10
50, 63	12	★ 186350	QS-G1/4-12
		578344	NPQH-D-G14-Q12-P10
		578366	NPQH-D-G14-S12-P10

Accessories

Dimensions

Download CAD data → [www.festo.com](http://www.festo.com)

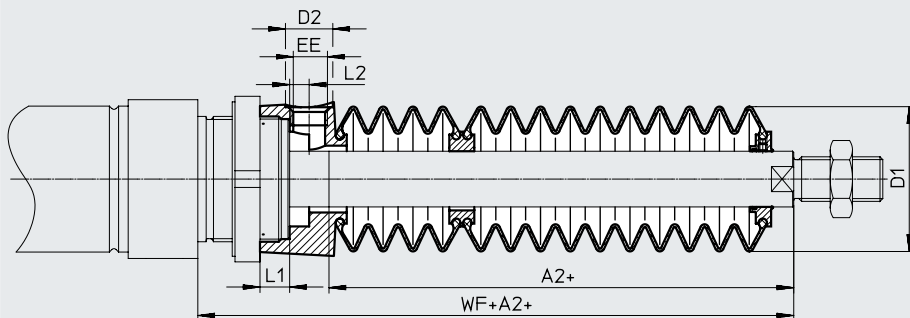

∅ Stroke [mm]	20							25						
	A2 <sup>1)</sup>	D1 ∅ max.	D2 ∅	EE	L1	L2	WF+A2	A2 <sup>1)</sup>	D1 ∅ max.	D2 ∅	EE	L1	L2	WF+A2
10 ... 50	22	29	8.5	M5	4.2	2.7	46	22	29	8.5	M5	4.2	2.7	50

∅ Stroke [mm]	32							40						
	A2 <sup>1)</sup>	D1 ∅ max.	D2 ∅	EE	L1	L2	WF+A2	A2 <sup>1)</sup>	D1 ∅ max.	D2 ∅	EE	L1	L2	WF+A2
10 ... 50	30	38	14	G1/8	12.9	5.4	64	29	46	14	G1/8	8.1	5.4	68

∅ Stroke [mm]	50/63						
	A2 <sup>1)</sup>	D1 ∅ max.	D2 ∅	EE	L1	L2	WF+A2
10 ... 50	30	57	17	G1/4	10.65	7	74/75

1) The dimension corresponds to the K8 value (extended piston rod) of the drive

Ordering data – Bellows kit

An extended piston rod (order code K8) is absolutely essential when using a bellows kit → Ordering data – Modular product system.

The necessary dimension for K8 as a function of piston diameter and cylinder stroke as well as the corresponding bellows kit is indicated in the table below:

Cylinder data			Bellows kit		Cylinder data			Bellows kit	
∅	Stroke	Dimension for K8	Part no.	Type	∅	Stroke	Dimension for K8	Part no.	Type
[mm]	[mm]	[mm]			[mm]	[mm]	[mm]		
20	10 ... 50	22	553407	DADB-S1-20-S10-50	25	10 ... 50	22	553421	DADB-S1-25-S10-50
32	10 ... 50	30	553441	DADB-S1-32-S10-50	40	10 ... 50	29	553461	DADB-S1-40-S10-50
50	10 ... 50	30	553481	DADB-S1-50-S10-50	63	10 ... 50	30	553501	DADB-S1-63-S10-50

## Accessories

**Ordering data – Proximity switch, round design, magneto-resistive** Datasheets → Internet: smto

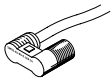
	Mounting	Switching output	Electrical connection		Cable length [m]	Outlet direction of connection	Part no.	Type
			Cable	Plug M8				
<b>N/O</b>								
	With accessories	PNP	3-wire	–	2.5	In-line	<b>152836</b>	<b>SMT0-4U-PS-K-LED-24</b>
			–	3-pin	–	In-line	<b>152742</b>	<b>SMT0-4U-PS-S-LED-24</b>
		NPN	3-wire	–	2.5	In-line	<b>152837</b>	<b>SMT0-4U-NS-K-LED-24</b>
			–	3-pin	–	In-line	<b>152743</b>	<b>SMT0-4U-NS-S-LED-24</b>

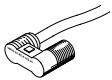

**Ordering data – Proximity switch, round design, magnetic reed** Datasheets → Internet: smeo

	Mounting	Electrical connection		Cable length [m]	Outlet direction of connection	Part no.	Type	
		Cable	Plug M8					
<b>N/O</b>								
	With accessories	3-wire	–	2.5	In-line	<b>36198</b>	<b>SMEO-4U-K-LED-24</b>	
			5	In-line	<b>175401</b>	<b>SMEO-4U-K5-LED-24</b>		
		–	3-pin	–	In-line	<b>151526</b>	<b>SMEO-4U-S-LED-24-B</b>	

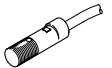
**Ordering data – Proximity switch, round design, magnetic reed, corrosion-resistant** Datasheets → Internet: crsmeo

	Mounting	Electrical connection		Cable length [m]	Outlet direction of connection	Part no.	Type	
		Cable	Plug M8					
<b>N/O</b>								
	With accessories	3-wire	–	2.5	In-line	<b>161775</b>	<b>CRSMEO-4-K-LED-24</b>	

**Ordering data – Mounting kits for proximity switch SMEO/SMT0/CRSMEO** Datasheets → Internet: smbr

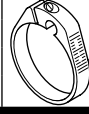
Designation	For ø	Part no.	Type	Designation	For ø	Part no.	Type
<b>Mounting kit SMBR</b>				<b>Mounting kit CRSMBR, corrosion resistant</b>			
	8	<b>19272</b>	<b>SMBR-8</b>		8	–	–
	10	<b>19273</b>	<b>SMBR-10</b>		10	–	–
	12	<b>19274</b>	<b>SMBR-12</b>		12	<b>164581</b>	<b>CRSMBR-12</b>
	16	<b>19275</b>	<b>SMBR-16</b>		16	<b>164582</b>	<b>CRSMBR-16</b>
	20	<b>19276</b>	<b>SMBR-20</b>		20	<b>164583</b>	<b>CRSMBR-20</b>
	25	<b>19277</b>	<b>SMBR-25</b>		25	<b>164584</b>	<b>CRSMBR-25</b>
					32	<b>163888</b>	<b>CRSMBR-32</b>
					40	<b>163889</b>	<b>CRSMBR-40</b>
					50	<b>163890</b>	<b>CRSMBR-50</b>
					63	<b>163891</b>	<b>CRSMBR-63</b>

Accessories

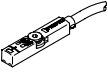
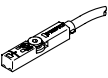
Ordering data – Proximity switch for T-slot, magneto-resistive						Datasheets → Internet: smt
	Type of mounting	Switching output	Electrical connection	Cable length [m]	Part no.	Type
<b>N/O</b>						
	Inserted in the slot from above, flush with the cylinder profile, short design	PNP	Cable, 3-wire	2.5	574335	SMT-8M-A-PS-24V-E-2.5-OE
			Plug M8x1, 3-pin	0.3	574334	SMT-8M-A-PS-24V-E-0.3-M8D
		NPN	Plug M12x1, 3-pin	0.3	574337	SMT-8M-A-PS-24V-E-0.3-M12
			Cable, 3-wire	2.5	574338	SMT-8M-A-NS-24V-E-2.5-OE
			Plug M8x1, 3-pin	0.3	574339	SMT-8M-A-NS-24V-E-0.3-M8D
<b>N/C</b>						
	Inserted in the slot from above, flush with the cylinder profile, short design	PNP	Cable, 3-wire	7.5	574340	SMT-8M-A-PO-24V-E-7.5-OE

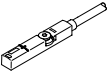
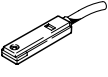
Ordering data – Proximity switch for T-slot, magnetic reed						Datasheets → Internet: sme
	Type of mounting	Switching output	Electrical connection	Cable length [m]	Part no.	Type
<b>N/O</b>						
	Inserted in the slot from above, flush with the cylinder profile	Contacting	Cable, 3-wire	2.5	543862	SME-8M-DS-24V-K-2.5-OE
				5.0	543863	SME-8M-DS-24V-K-5.0-OE
			Cable, 2-wire	2.5	543872	SME-8M-ZS-24V-K-2.5-OE
			Plug M8x1, 3-pin	0.3	543861	SME-8M-DS-24V-K-0.3-M8D
<b>N/C</b>						
	Inserted in the slot lengthwise, flush with the cylinder profile	Contacting	Cable, 3-wire	7.5	160251	SME-8-O-K-LED-24

Ordering data – Mounting kits for proximity switch SME/SMT-8				Datasheets → Internet: smbr
Designation	For ø	Part no.	Type	
<b>Mounting kit SMBR-8</b>				
	8	175091	SMBR-8-8	
	10	175092	SMBR-8-10	
	12	175093	SMBR-8-12	
	16	175094	SMBR-8-16	
	20	175095	SMBR-8-20	
	25	175096	SMBR-8-25	
	32	175097	SMBR-8-32	
	40	175098	SMBR-8-40	
	50	175099	SMBR-8-50	
	63	175100	SMBR-8-63	

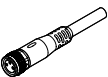
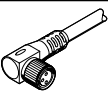
Ordering data – Connecting cables					Datasheets → Internet: nebu
	Electrical connection, left	Electrical connection, right	Cable length [m]	Part no.	Type
	Straight socket, M8x1, 3-pin	Cable, open end, 3-wire	2.5	541333	NEBU-M8G3-K-2.5-LE3
			5	541334	NEBU-M8G3-K-5-LE3
	Straight socket, M12x1, 5-pin	Cable, open end, 3-wire	2.5	541363	NEBU-M12G5-K-2.5-LE3
			5	541364	NEBU-M12G5-K-5-LE3
	Angled socket, M8x1, 3-pin	Cable, open end, 3-wire	2.5	541338	NEBU-M8W3-K-2.5-LE3
			5	541341	NEBU-M8W3-K-5-LE3
	Angled socket, M12x1, 5-pin	Cable, open end, 3-wire	2.5	541367	NEBU-M12W5-K-2.5-LE3
			5	541370	NEBU-M12W5-K-5-LE3

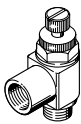

## Accessories

Ordering data – One-way flow control valves				Datasheets → Internet: grl	
	Connection thread	For tubing O.D.	Material	Part no.	Type
<b>For supply air</b>					
	M5	3	Metal design	193153	GRLZ-M5-QS-3-D
		4		193154	GRLZ-M5-QS-4-D
		6		193155	GRLZ-M5-QS-6-D
	G1/8	3		193156	GRLZ-1/8-QS-3-D
		4		193157	GRLZ-1/8-QS-4-D
		6		193158	GRLZ-1/8-QS-6-D
		8		193159	GRLZ-1/8-QS-8-D