

General Description

The SM80593L is a high efficiency 1MHz synchronous step down DC/DC regulator, which is capable of delivering up to 3A output current. It can operate over a wide input voltage range from 2.5V to 5.5V and integrate main switch and synchronous switch with very low $R_{DS(ON)}$ to minimize the conduction loss.

The SM80593L integrates reliable latch off function when output over voltage, output short or thermal shutdown happens.

The low output voltage ripple, the small external inductor and the capacitor sizes are achieved with 1MHz switching frequency.

Ordering Information

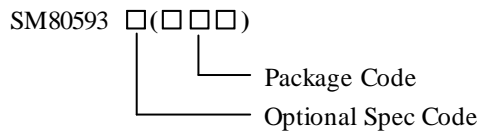

Ordering Number	Package type	Note
SM80593LDQC	DFN1.5×1.5-6	--

Features

- 2.5V to 5.5V Input Voltage Range
- 55μA Low Quiescent Current
- Low $R_{DS(ON)}$ for Internal Switches (Top/Bottom): 85mΩ / 60mΩ
- High Switching Frequency 1MHz Minimizes the External Components
- Internal Soft-start Limits the Inrush Current
- 100% Dropout Operation
- Power Good Indicator
- Reliable Latch off Function When:
 - Output Short
 - Thermal Shutdown
 - Output Voltage > 120% of Regulated Voltage
- Output Auto Discharge Function
- RoHS Compliant and Halogen Free
- Compact Package: DFN1.5×1.5-6

Applications

- Set Top Box
- USB Dongle
- Media Player
- Smart Phone

Typical Application

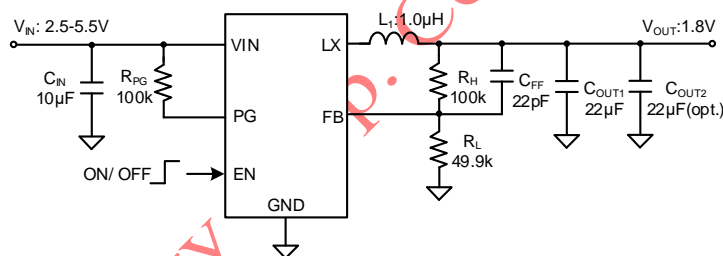

Inductor and C_{OUT} Selection Table

V_{OUT} [V]	L [μH]	C_{OUT} [μF]		
		10	22	22×2
1.2/1.8/3.3	1.0		√	☆
	1.5		√	√
	2.2		√	√

Note: '☆' means recommended for most applications.

Figure1. Schematic Diagram

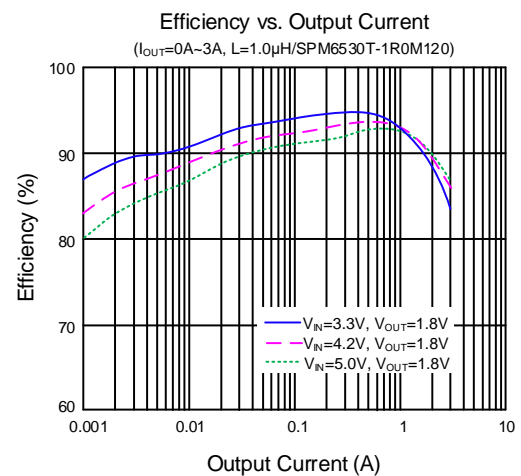
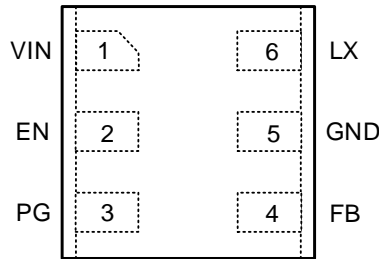

Figure2. Efficiency vs. Output Current

Pin out (Top View)



(DFN1.5x1.5-6)

Top Mark: N3xyz (device code: N3, x=year code, y=week code, z= lot number code)

Pin Name	Pin No.	Pin Description
VIN	1	Input pin. Decouple this pin to GND pin with at least a 10 μ F ceramic capacitor.
EN	2	Enable control. Pull high to turn on. Do not leave it floating.
PG	3	Power good indicator. Power good indicator (open drain output). Low if the output < 90% or the output > 120% of regulation voltage; High otherwise. Connect a pull-up resistor to the input.
FB	4	Output feedback pin. Connect this pin to the center point of the output resistor divider (as shown in Figure 1) to program the output voltage: $V_{OUT}=0.6 \times (1+R_H/R_L)$.
GND	5	Ground pin.
LX	6	Inductor pin. Connect this pin to the switching node of inductor.

Block Diagram

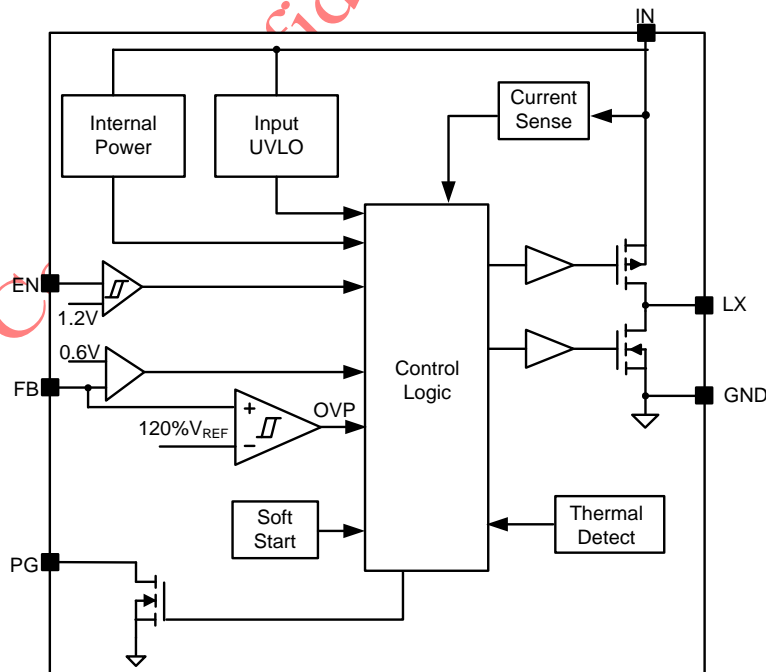

Figure3. Block Diagram



Absolute Maximum Ratings (Note 1)

Supply Input Voltage-----	-0.3V to 6.0V
FB, EN, PG Voltage-----	-0.3V to V _{IN} + 0.6V
LX Voltage-----	-0.3V ^(*1) to 6.0V ^(*2)
Power Dissipation, P _D @ T _A = 25 °C -----	1.3W
Package Thermal Resistance (Note 2)	
θ _{JA} -----	75 °C/W
θ _{JC} -----	25 °C/W
Junction Temperature Range -----	-40 °C to 150 °C
Lead Temperature (Soldering, 10 sec.) -----	260 °C
Storage Temperature Range -----	-65 °C to 150 °C
^(*1) LX Voltage Tested Down to -3V <20ns	
^(*2) LX Voltage Tested Up to +7V <20ns	

Recommended Operating Conditions (Note 3)

Supply Input Voltage -----	2.5V to 5.5V
Junction Temperature Range -----	-40 °C to 125 °C
Ambient Temperature Range -----	-40 °C to 85 °C

Silergy Corp. Confidential Prepared for PPT

Electrical Characteristics

($V_{IN} = 5V$, $V_{OUT} = 1.8V$, $L = 1.0\mu H$, $C_{OUT} = 44\mu F$, $T_A = 25^\circ C$, unless otherwise specified)

Parameter	Symbol	Test Conditions	Min	Typ	Max	Unit
Input Voltage Range	V_{IN}		2.5		5.5	V
Input UVLO Threshold	V_{UVLO}			2.45	2.5	V
Input UVLO Hysteresis	V_{YST}			150		mV
Quiescent Current	I_Q	$V_{FB}=105\% \times V_{REF}$		55		μA
Shutdown Current	I_{SHDN}	$V_{EN}=0V$		0.1	1	μA
Feedback Reference Voltage	V_{REF}	$I_{OUT}=0.5A$, CCM	0.591	0.6	0.609	V
LX Node Discharge Resistance	R_{DIS}			50		Ω
Top FET R_{ON}	$R_{DS(ON)1}$			85		m Ω
Bottom FET R_{ON}	$R_{DS(ON)2}$			60		m Ω
EN Input Voltage High	$V_{EN,H}$		1.2			V
EN Input Voltage Low	$V_{EN,L}$				0.4	V
PG Threshold for Under Voltage Detection	$V_{PG,UVP}$			90		%
PG Low Delay Time for Under Voltage Detection	$t_{UVP,DLY}$			10		us
PG Threshold for Over Voltage Detection	$V_{PG,OVV}$			120		%
PG Low Delay Time for Over Voltage Detection	$t_{OVV,DLY}$			20		us
Min ON Time	$t_{ON,MIN}$			50		ns
Maximum Duty Cycle	D_{MAX}		100			%
Turn on Delay Time	$t_{ON,DLY}$	from EN high to LX start switching		0.5		ms
Soft-start Time	t_{SS}	V_{OUT} from 0% to 100%		1		ms
Switching Frequency	f_{SW}	$I_{OUT}=0.5A$, CCM		1		MHz
Top FET Current Limit	$I_{LMT, TOP}$		3.5			A
Thermal Shutdown Temperature	T_{SD}			160		$^\circ C$

Note 1: Stresses beyond the “Absolute Maximum Ratings” may cause permanent damage to the device. These are stress ratings only. Functional operation of the device at these or any other conditions beyond those indicated in the operational sections of the specification is not implied. Exposure to absolute maximum rating conditions for extended periods may affect device reliability.

Note 2: θ_{JA} of SM80593L is measured in the natural convection at $T_A = 25^\circ C$ on a 2-oz two-layer Silergy evaluation board. Pin 6 is the case position for θ_{JC} measurement.

Note 3: The device is not guaranteed to function outside its operating conditions.

Typical Performance Characteristics

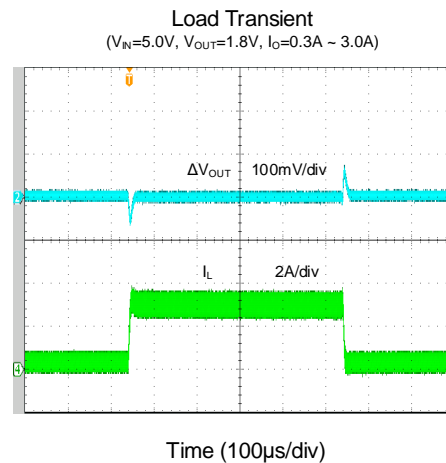
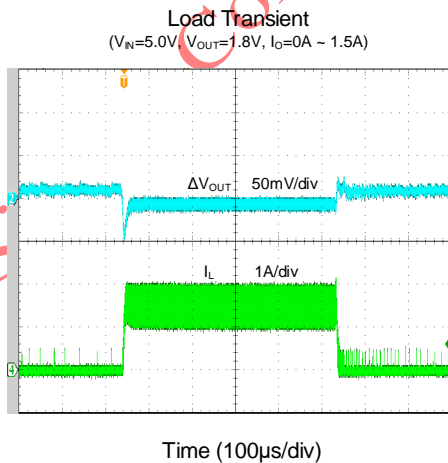
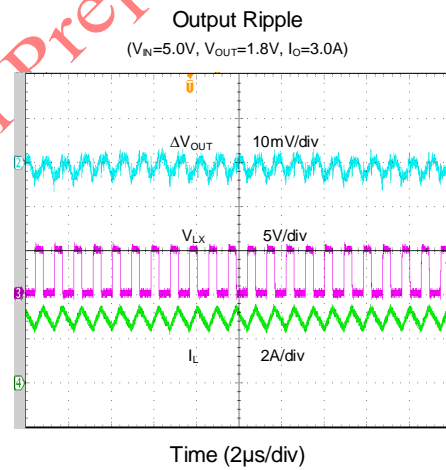
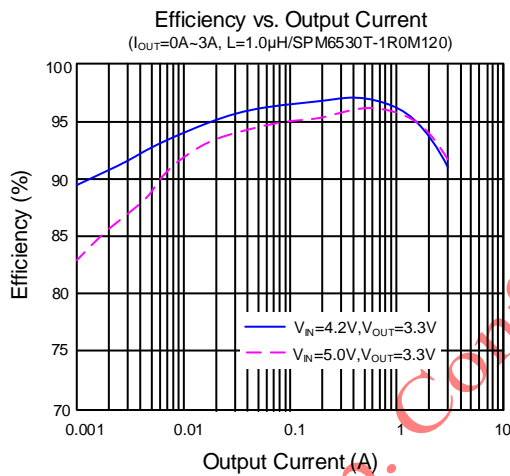
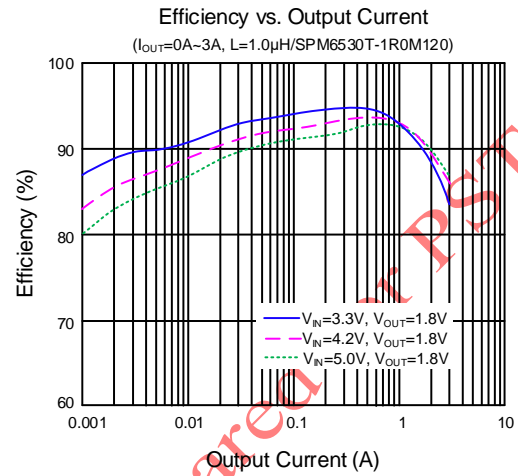
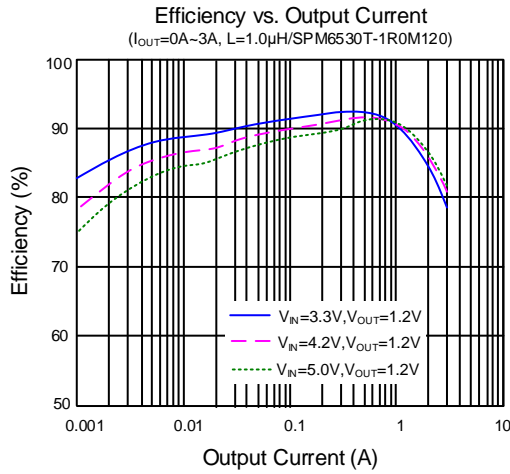

Startup from Enable
 ($V_{IN}=5.0V, V_{OUT}=1.8V, R_{LOAD}=0.6\Omega$)

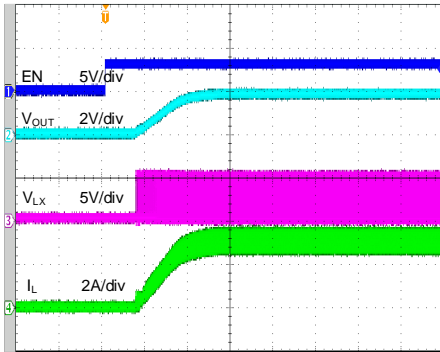

Time (800µs/div)

Shutdown from Enable
 ($V_{IN}=5.0V, V_{OUT}=1.8V, R_{LOAD}=0.6\Omega$)

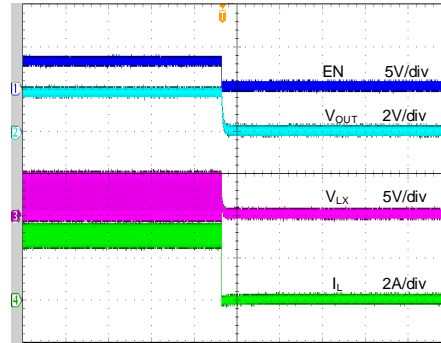

Time (800µs/div)

Short Circuit Protection
 ($V_{IN}=5.0V, V_{OUT}=1.8V, I_O=0A \sim$ Short)

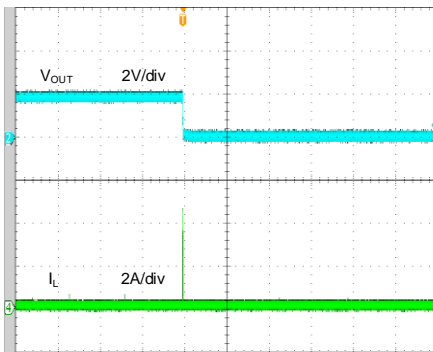

Time (4ms/div)

Short Circuit Protection
 ($V_{IN}=5.0V, V_{OUT}=1.8V, I_O=3A \sim$ Short)

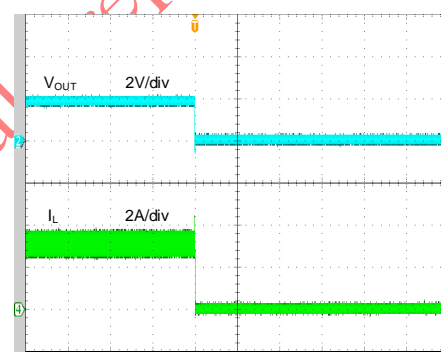

Time (4ms/div)

Operation

The SM80593L is a high efficiency 1MHz synchronous step down DC/DC regulator, which is capable of delivering up to 3A output current. It can operate over a wide input voltage range from 2.5V to 5.5V and integrate main switch and synchronous switch with very low $R_{DS(ON)}$ to minimize the conduction loss.

The SM80593L integrates reliable latch off function when output over voltage, output short or thermal shutdown happens.

The low output voltage ripple, the small external inductor and the capacitor sizes are achieved with 1MHz switching frequency.

Short Circuit Protection

After the soft-start is over, if the output voltage falls below 50% of the regulation level, the IC will turn off both power switches, then will enter short circuit protection. It will remain in this state until the IN or EN voltage is recycled.

Over Voltage Protection

If the output voltage exceeds 120% of the regulation level, the IC will turn off both power switches and turn on the discharge switch, then will enter over voltage protection. It will remain in this state until the IN or EN voltage is recycled.

Thermal Shutdown Protection

If the junction temperature of the SM80593L is greater than the thermal shutdown temperature (TSD), the IC will turn off both power switches, and then will enter thermal shutdown protection. It will remain in this state until the IN or EN voltage is recycled.

Applications Information

Because of the high integration in the SM80593L, the application circuit based on this IC is rather simple. Only the input capacitor C_{IN} , the output capacitor C_{OUT} , the output inductor L and the feedback resistors (R_H and R_L) need to be selected for the targeted applications specifications.

Feedback Resistor Dividers R_H and R_L

Choose R_H and R_L to program the proper output voltage. To minimize the power consumption under light loads, it is desirable to choose large resistance

values for both R_H and R_L . A value of between 10k Ω and 200k Ω is highly recommended for R_L . If $R_L=100k\Omega$ is chosen, then R_H can be calculated to be:

$$R_H = \frac{(V_{OUT} - 0.6V) \times R_L}{0.6V}$$

Input Capacitor C_{IN}

A typical X5R or better grade ceramic capacitor with 10V rating and greater than 10 μ F capacitance is recommended. This ceramic capacitor need to be placed really close to the IN and GND pins to minimize the potential noise problem. Care should be taken to minimize the loop area formed by C_{IN} , and the IN/GND pins.

Output Capacitor C_{OUT}

The output capacitor is selected to handle the output ripple noise requirements. Both steady state ripple and transient requirements must be taken into consideration when selecting this capacitor. For the best performance, it is recommended to use an X5R or better grade ceramic capacitor with 6.3V rating and greater than 22 μ F capacitance.

Output Inductor L

There are several considerations in choosing this inductor.

- 1) Choose the inductance to provide the desired ripple current. It is suggested to choose the ripple current to be about 40% of the maximum output current. The inductance is calculated as:

$$L = \frac{V_{OUT}(1 - V_{OUT}/V_{IN,MAX})}{f_{SW} \times I_{OUT,MAX} \times 40\%}$$

Where f_{SW} is the switching frequency and $I_{OUT,MAX}$ is the maximum load current.

The SM80593L is quite tolerant of different ripple current amplitude. Consequently, the final choice of inductance can be slightly off the calculation value without significantly impacting the performance.

- 2) The saturation current rating of the inductor must be selected to be greater than the peak inductor current under full load conditions.

$$I_{SAT, MIN} > I_{OUT, MAX} + \frac{V_{OUT}(1 - V_{OUT}/V_{IN,MAX})}{2 \times f_{SW} \times L}$$

- 3) The DCR of the inductor and the core loss at the switching frequency must be low enough to achieve the desired efficiency requirement. It is

desirable to choose an inductor with $DCR < 30m\Omega$ to achieve a good overall efficiency.

Load Transient Considerations

The SM80593L integrates the compensation components to achieve good stability and fast transient responses. In some application, adding a ceramic capacitor (feed-forward capacitor, C_{ff}) in parallel with R_H may further speed up the load transient responses and is thus recommended for applications with large load transient step requirements. Typically, for 1.2V/1.8V/3.3V output, the R_H , R_L , C_{ff} is recommended as below:

Recommended Component Selection

V_{OUT}	R_H	R_L	C_{ff}
1.2V	49.9k Ω	49.9k Ω	22pF
1.8V	100k Ω	49.9k Ω	22pF
3.3V	100k Ω	22.1k Ω	22pF

OCP Protection Method

With load current increasing, as soon as the high side FET current gets higher than peak current limit threshold, the high side FET will turn off. If the load current continues to increase, the output voltage will drop. When the output voltage falls below 50% of the regulation level, the output UVP will be detected and the SM80593L will operate in latch off mode.

Layout Design

The layout design of the SM80593L regulator is relatively simple. For the best efficiency and minimum noise problems, the following components should be placed close to the IC: C_{IN} , L, R_H and R_L .

- 1) It is desirable to maximize the PCB copper area connecting to the GND pin to achieve the best thermal and noise performance. If the board space allowed, a ground plane is highly desirable.
- 2) C_{IN} must be close to the Pins IN and GND. The loop area formed by C_{IN} and GND must be minimized.
- 3) The PCB copper area associated with the LX pin must be minimized to avoid the potential noise problem.
- 4) The components R_H , R_L and the trace connecting to the FB pin must NOT be adjacent to the LX net on the PCB layout to avoid the noise problem.

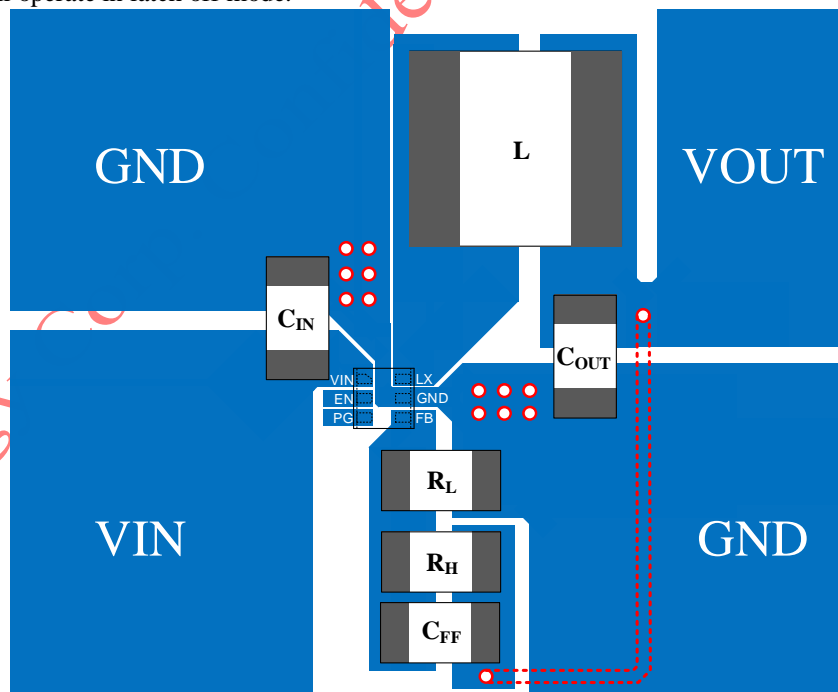
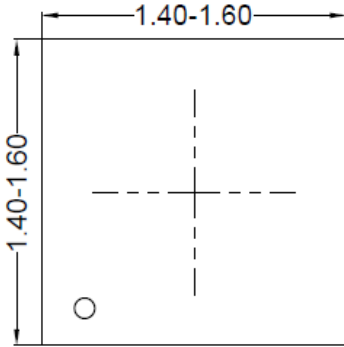
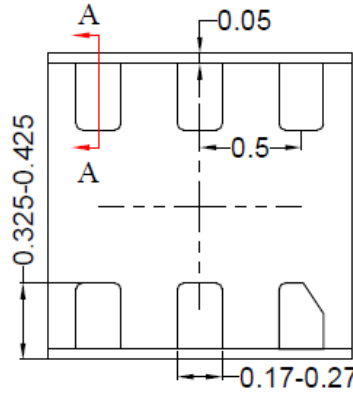

Figure4. PCB Layout Suggestion

DFN1.5×1.5-6 Package Outline



Top View



Bottom View

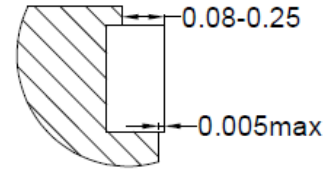

A-A

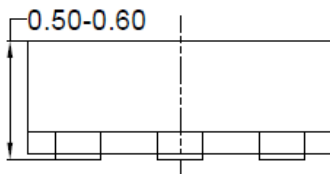

Front View

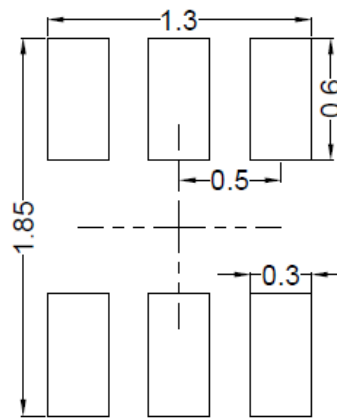

**Recommended PCB layout
(only for reference)**

- Notes:**
- 1, All dimension in millimeter and exclude mold flash & metal burr;**
 - 2, center line refers the chip body center**