

»Features

$V_{CE} = -50V$
 $I_C = -150mA$
 $f_T = 80MHz @ V_{CE} = -10V, I_C = -1mA, f = 30MHz$

»Pin Configurations

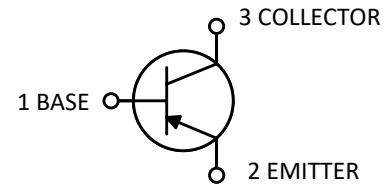

»General Description

- Complementary to C1815
- Epitaxial planar die constructio
- SOT-23 Plastic Package

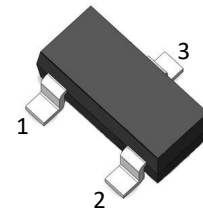

»Absolute Maximum Ratings @ $T_A = 25^\circ C$ unless otherwise noted

Symbol	Parameter	Value	Unit
V_{CBO}	Collector-Base Voltage	-50	V
V_{CEO}	Collector-Emitter Voltage	-50	V
V_{EBO}	Emitter-Base Voltage	-5	V
I_C	Collector Current	-150	mA
P_C	Collector Power Dissipation	200	mW
$R_{\theta JA}$	Thermal Resistance From Junction To Ambient	625	$^\circ C/W$
T_J, T_{stg}	Operation Junction And Storage Temperature Range	-55 ~ +150	$^\circ C$

»Electrical Characteristics @ $T_A = 25^\circ C$ unless otherwise noted

Symbol	Parameter	Test conditions	Min	Typ	Max	Unit
$V_{(BR)CBO}$	Collector-base breakdown voltage	$I_C = -100\mu A, I_E = 0$	-50			V
$V_{(BR)CEO}$	Collector-emitter breakdown voltage	$I_C = -100\mu A, I_B = 0$	-50			V
$V_{(BR)EBO}$	Emitter-base breakdown voltage	$I_E = -100\mu A, I_C = 0$	-5			V
I_{CBO}	Collector cut-off current	$V_{CB} = -50V, I_E = 0$			-100	nA
I_{CEO}	Collector cut-off current	$V_{CB} = -50V, I_B = 0$			-1	μA
I_{EBO}	Emitter cut-off current	$V_{EB} = -5V, I_C = 0$			-100	nA
h_{FE}	DC current gain	$V_{CE} = -5V, I_C = -1mA$	120		400	
$V_{CE(sat)}$	Collector-emitter saturation voltage	$I_C = -100mA, I_B = -10mA$			-0.3	V
$V_{BE(sat)}$	Base-emitter saturation voltage				-1.1	V
f_T	Transition frequency	$V_{CE} = -10V, I_C = -1mA, f = 30MHz$	80			MHz

»Typical Performance Characteristics (($T_J = 25\text{ }^\circ\text{C}$, unless otherwise noted))

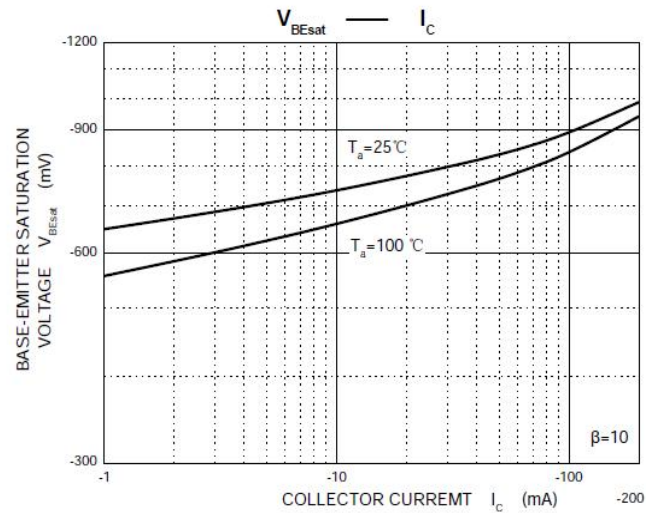
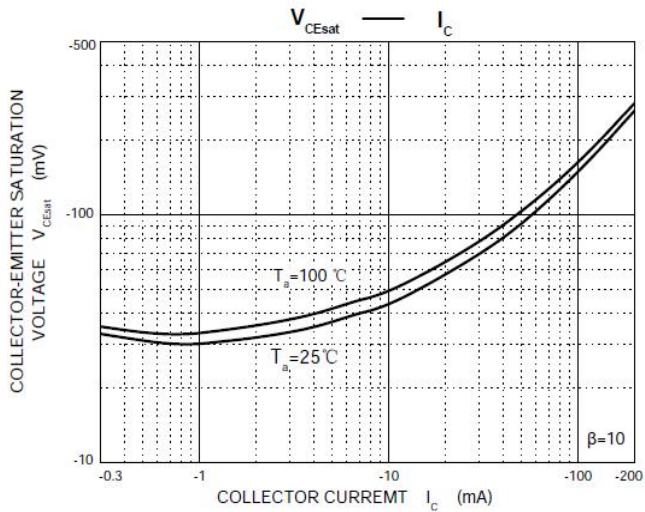
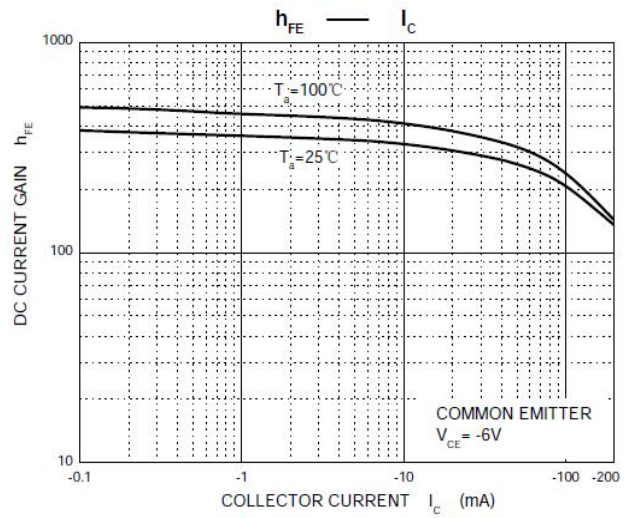
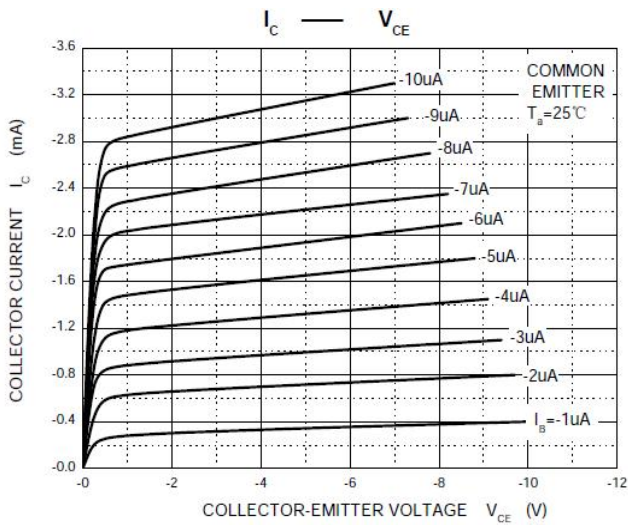

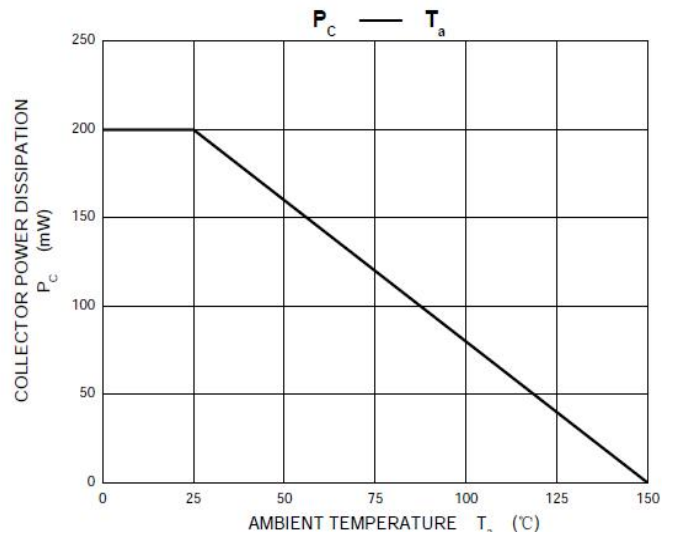
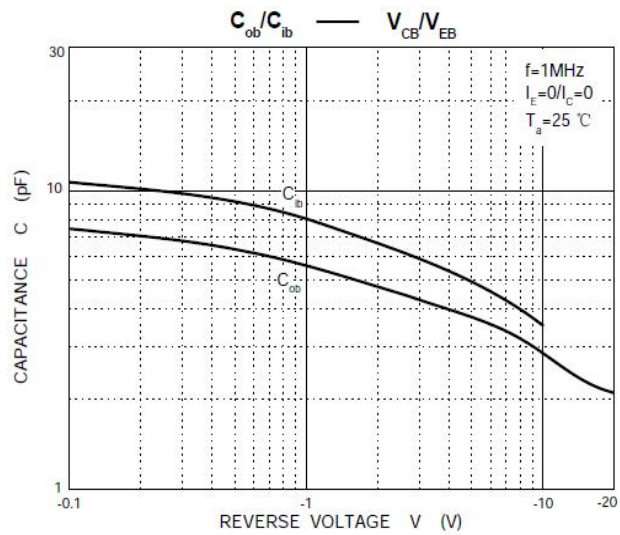
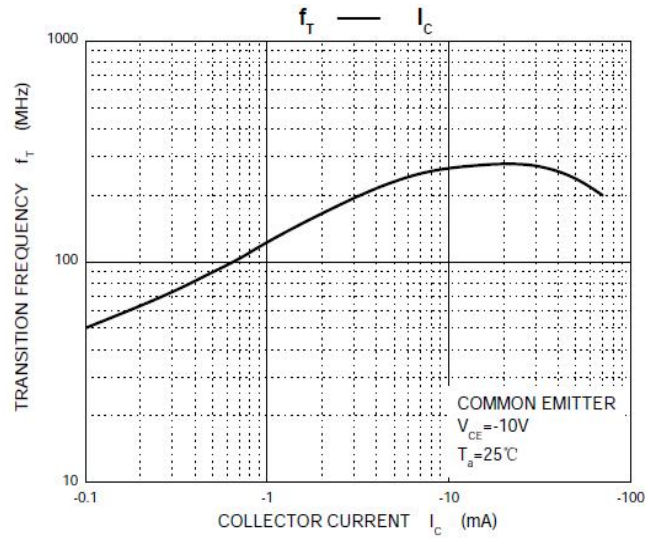
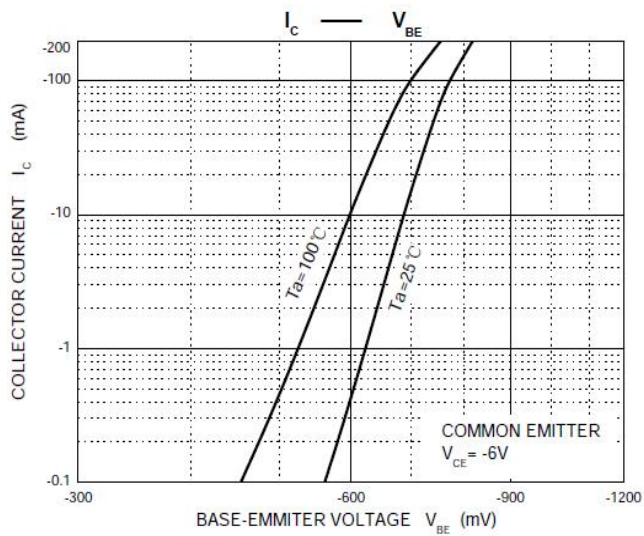

»Package Information SOT-23

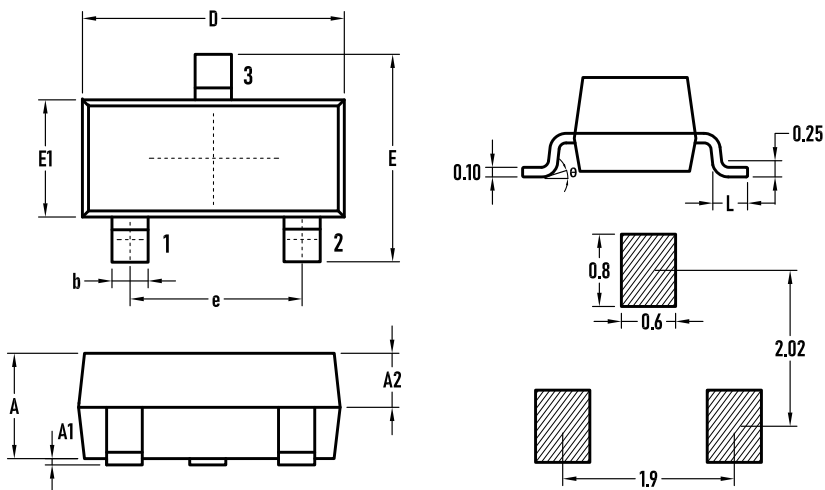

SYMBOL	MILLIMETER		
	MIN.	Typ	MAX
A	0.90	1.00	1.10
A1	0.02	0.06	0.10
A2	–	0.60	–
D	2.85	2.90	2.95
b	0.37	0.40	0.43
E	2.35	2.40	2.45
E1	1.25	1.30	1.35
e	1.85	1.90	1.95
L	0.35	0.40	0.48
θ	0	–	6°

»HFE Classifications & Marking

h_{FE}	120~240	200~400
Marking		

»Ordering information

Order code	Package	Base qty	Delivery mode
A733	SOT-23	3K	Tape and reel