

UNCONTROLLED DOCUMENT

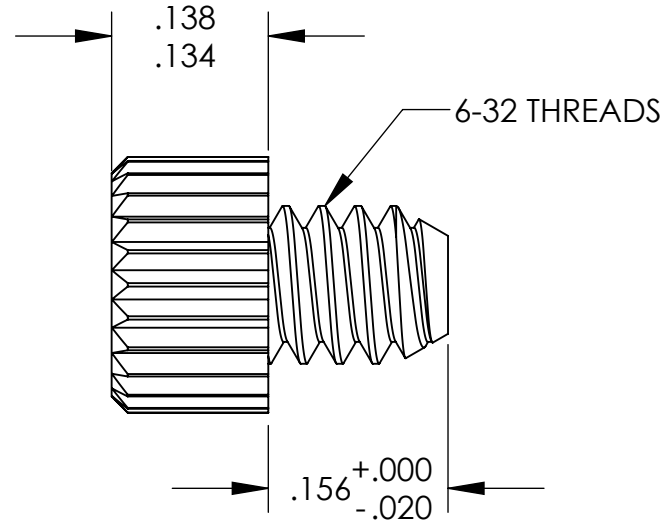
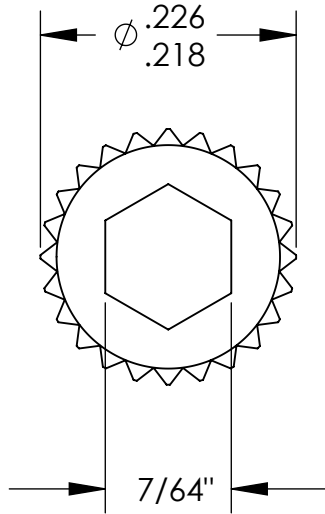

NOTES:
.064 MINIMUM KEY ENGAGEMENT

TOLERANCES UNLESS NOTED

- ±.005 ON DIMENSIONS THRU .625
- ±.008 ON DIMENSIONS .626 THRU 1.000
- ±.010 ON DIMENSIONS 1.001 THRU 1.500
- ±.015 ON DIMENSIONS LARGER THAN 1.500
- ±.015 ON FRACTIONAL DIMENSIONS

**WE RESERVE THE RIGHT
TO DISCONTINUE ITEMS,
CHANGE SPECIFICATIONS
OR DESIGN AT ANY TIME
WITHOUT NOTICE AND
WITHOUT INCURRING
ANY OBLIGATIONS**

| | | |
|---|-------|------------|
| PROPERTY OF | | |
| MICRO PLASTICS INC. | | |
| CATALOG DRAWING HEX SOCKET CAP MACHINE SCREW MICRO P/N 3406320015 DWG. # 3406320015 FILE SERVER\ENG\WEB | | |
| MATERIAL: | | 6/6 NYLON |
| DATE | SCALE | JDD |
| | 6:1 | |