

# HRXL-MaxSonar® - WRS™ Series

High Resolution, IP67 Weather Resistant, Ultrasonic

Snow Depth Sensor / MB7334, MB7344, MB7354, MB7364, MB7374, MB7384<sup>6</sup>



The HRXL-MaxSonar-WRS sensor line is a cost-effective solution for applications where precision range-finding, low-voltage operation, space saving, low-cost, and IP67 weather resistance rating is needed. This sensor component module allows users of other, more costly precision ultrasonic snow depth measurement rangefinders to lower the cost of their systems without sacrificing performance. Additionally, this sensor line allows cost-sensitive designers to choose this precision sensor as a performance upgrade over other lower performance sensors. The HRXL-MaxSonar-WRS sensor line provides high accuracy and high resolution ultrasonic proximity detection and ranging in air, with an IP67 weather resistant rating. This sensor line features 1-mm resolution, target-size and operating-voltage compensation for improved accuracy, superior rejection of outside noise sources, internal speed-of-sound temperature compensation and optional external speed-of-sound temperature compensation. The HRXL-MaxSonar-WRS sensors have a maximum range of 5-meters.

This ultrasonic sensor detects objects from 1-mm and ranges to objects from 50-cm to maximum range. Objects closer than 50-cm are typically reported as 50-cm. The interface output formats are pulse width, analog voltage, and digital serial in either RS232 or TTL . Factory calibration is standard.

## Precision Ultrasonic Range Sensing

- Range-finding at a fraction of the cost of other precision rangefinders
- Reading-to-reading stability of 1-mm at 1-meter is typical<sup>1</sup>
- Accuracy is factory-matched providing a typical accuracy of 1% or better<sup>1,2</sup>
- Compensation provided for target size variation and operating voltage range
- Internal temperature compensation is standard
- Optional external temperature compensation
- Determines range to first detectable object
- Excellent clutter rejection
- Additional chemical resistance available<sup>4</sup>

## Very Low Power Requirements

- Wide, low supply voltage requirements eases battery powered design
- Low current draw reduces current drain for battery operation
- Fast first reading after power-up eases battery requirements
- Very low-power rangefinder, excellent for multiple sensor or battery based systems

## Easy to use Component Module

- Gracefully handles other ultrasonic sensors<sup>3</sup>
- Stable and reliable range readings and excellent noise rejection make the sensor easy to use for most users
- Easy to use interface with distance provided in a variety of output
- Target size compensation provides greater consistency and accuracy

- Sensor automatically handles acoustic noise<sup>1,2</sup>
- Small and easy to mount
- Calibrated sensor eliminates most sensor to sensor variations

## Applications & Uses

- Weather station monitoring
- Snow level measurement (MB7354, MB7374)
- Bin level measurement
- Corn level measurement
- People detection
- This product is not recommended as a device for personal safety

### Notes:

<sup>1</sup> Users are encouraged to evaluate the sensor performance in their application  
<sup>2</sup> by design  
<sup>3</sup> See page 9 for multi-sensor operation  
<sup>4</sup> F-Option and P-Option provide additional protection from hazardous chemical environments  
<sup>5</sup> Please reference page 12 for minimum operating voltage verses temperature information  
<sup>6</sup> Please reference page 17 for part number key.

## Close Range Operation

Applications requiring 100% reading-to-reading reliability should not use MaxSonar sensors at a distance closer than 50cm. Although most users find MaxSonar sensors to work reliably from 0 to 50cm for detecting objects in many applications, MaxBotix® Inc. does not guarantee operational reliability for objects closer than the minimum reported distance. Because of ultrasonic physics, these sensors are unable to achieve 100% reliability at close distances.

## Warning: Personal Safety Applications

We do not recommend or endorse this product be used as a component in any personal safety applications. This product is not designed, intended or authorized for such use. These sensors and controls do not include the self-checking redundant circuitry needed for such use. Such unauthorized use may create a failure of the MaxBotix® Inc. product which may result in personal injury or death. MaxBotix® Inc. will not be held liable for unauthorized use of this component.

**General Characteristics**

- Low cost ultrasonic rangefinder
- Detection out to 5-meters
- Resolution of 1-mm
- Distance sensor from 50-cm to 5-meters
- Excellent<sup>1</sup> Mean Time Between Failure (MTBF)
- Triggered operation yields real-time range data
- Free run operation with superior noise rejection<sup>3</sup>

- Operating temperature range from -40°C to +65°C
- Operating voltage from 2.7V to 5.5V
- Best operated at 5V for snow applications
- Nominal current draw of 2.3mA at 3.3V, and 3.1mA at 5V
- IP67 Rated

**Range Outputs**

- Pulse width, 1uS/mm resolution
- Analog Voltage, 5-mm resolution
- Serial, 1-mm resolution
- Available in RS232 or TTL

**About Ultrasonic Sensors**

Our ultrasonic sensors are, non-contact object detection and ranging sensors that detect objects in air, within an area. These sensors are not affected by color or other visual characteristics of the detected object. Ultrasonic sensors use high frequency sound to detect and localize objects in a variety of environments. Ultrasonic sensors measure the time of flight for sound that has been transmitted to and reflected back from nearby objects. Based upon the time of flight, the sensor then outputs a range reading.

**HRXL-MaxSonar-WRS**

The HRXL-MaxSonar-WRS is a low-cost, rugged ultrasonic snow depth sensor that is optimized for reliable snow depth measurement. Internally, multiple sensor readings are analyzed using algorithms optimized for snow measurement, ensuring accurate snow depth measurements. The sensor accurately applies temperature compensation to every reading, using either the integrated temperature sensor or the optional external temperature sensor (HR-MaxTemp).

**HRXL-MaxSonar®-WRS™ Mechanical Dimensions**

**3/4" NPS WR Housing**

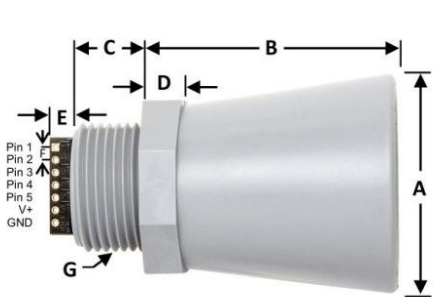

Values Are Nominal

A	1.72" dia.	43.8 mm dia.
B	2.00"	50.7 mm
C	0.58"	14.4 mm
D	0.31"	7.9 mm
E	0.23"	5.8 mm
F	0.1"	2.54 mm
G	3/4" - 14 National Pipe Thread Straight	
H	1.032" dia.	26.2 mm dia.
I	1.37"	34.8 mm
Weight, 1.76 oz., 50 grams		

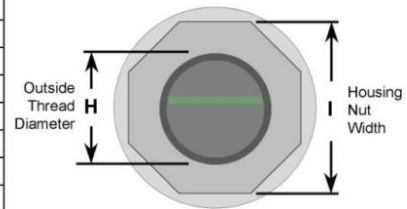

**Extended Horn**

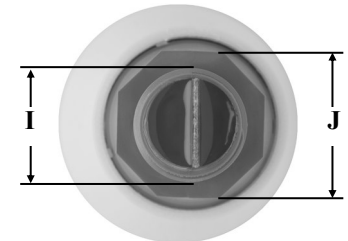
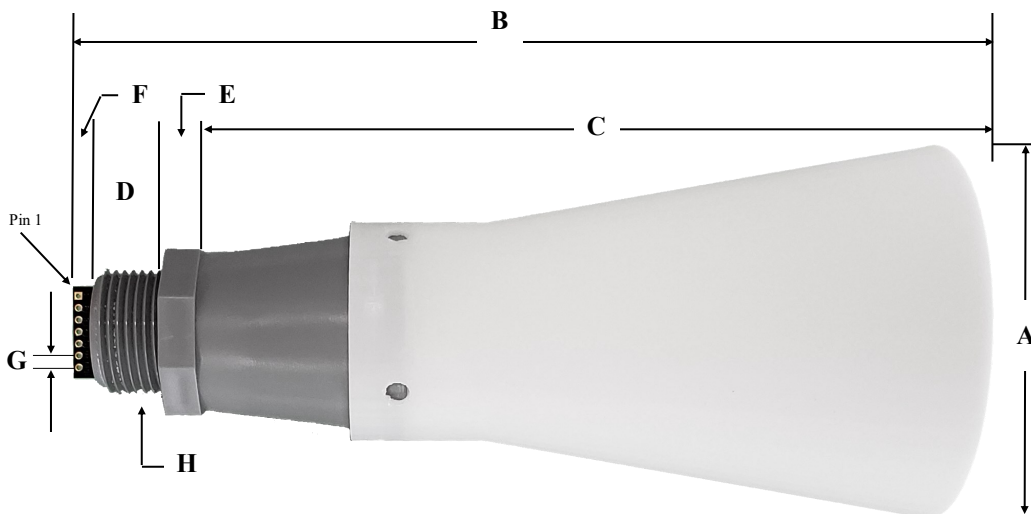

A	3.12" dia.	79.3 mm dia.
B	7.20"	182.9 mm
C	6.09"	154.8 mm
D	0.58"	14.4 mm
E	0.31"	7.9 mm
F	0.23"	5.8 mm
G	0.10"	2.54 mm
H	3/4" - 14 National Pipe Thread Straight	
I	1.03" dia.	26.2 mm dia.
J	1.37"	34.8 mm
Weight, 1.10 oz., 31.1 grams		

Values Are Nominal

## HRXL-MaxSonar-WR Pin Out

**Pin 1- Temperature Sensor Connection:** Leave this pin unconnected if an external temperature sensor is not used. For best accuracy, this pin is optionally connected to the HR-MaxTemp temperature sensor. Some additional information for the temperature sensor can be found on page 8 of the datasheet.

**Pin 2- Pulse Width Output:** This pin outputs a pulse width representation of the distance with a scale factor of 1uS per mm. The pulse width output is sent with a value within 0.5% of the serial output.

**Pin 3- Analog Voltage Output:** This pin outputs a single ended analog voltage scaled representation of the distance. This output is referenced to the sensor ground and Vcc. After the ~50mS power up initialization, the voltage on this pin is set to a low voltage. Once the sensor has completed a range reading the voltage on this pin is set to the voltage corresponding to the latest measured distance.

The HRXL-MaxSonar-WRS sensors use a scale factor of (Vcc/5120) per 1-mm. The distance is output with a 5-mm resolution. The analog voltage output is typically within ±5-mm of the serial output.

Using a 10-bit analog to digital converter with the HRXL-MaxSonar-WRS sensors, one can read the analog voltage counts (i.e. 0 to 1023) directly and just multiply the number of counts in the value by 5 to yield the range in mm. For example, a converted value of 60 corresponds to 300-mm (where 60 x 5 = 300), and 1000 counts corresponds to 5,000-mm (where 1000 x 5 = 5,000-mm).

**Pin 4- Ranging Start/Stop:** This pin is internally pulled high. If this pin is left unconnected or held high, the sensor will continually measure and output the range data. If held low, the HRXL-MaxSonar-WRS will stop ranging. Bring high for 20uS or longer to command a range reading.

**Filtered Range Data:** When pin 4 is left high on the sensors, the sensors will continue to range. The data that is output includes a filter for increased accuracy. The sensors will output the range based on recent range information. The filter does not affect the speed at which data is made available to the user but instead allows for more consistent range information to be presented. For sensor specific timing and filter information refer to pages 10 and 11.

**Real-time Range Data:** When pin 4 is low and then brought high, the sensor will operate in real time and the first reading output will be the range measured from this first commanded range reading. When the sensor tracks that the RX pin is low after each range reading, and then the RX pin is brought high, unfiltered real time range information can be obtained. For timing information please refer to pages 10 and 11.

**Pin 5-Serial Output:** The MB7334, MB7354, and MB7364 sensors have an RS232 data format (with 0V to Vcc levels) and the MB7344, MB7374, and MB7384 sensors have a TTL outputs. The output is an ASCII capital “R”, followed by four ASCII character digits representing the range in millimeters, followed by a carriage return (ASCII 13). The maximum range reported is 4999 mm. A range value of 5000 corresponds to no target being detected in the field of view.

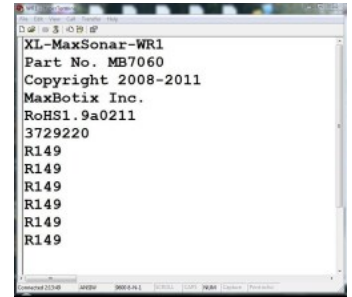

The serial data format is 9600 baud, 8 data bits, no parity, with one stop bit (9600-8-N-1). On power up the sensor will send serial data about the sensor. [View an example here.](#)

Because the data is presented in a binary data format, the serial output is most accurate .

**V+ Pin 6 - Positive Power, Vcc:** The sensor operates on voltages from 2.7V - 5.5V DC. For best operation, the sensor requires that the DC power be free from electrical noise. For installations monitoring snow, powering the sensor at 5V will provide the best results. (For installations with known dirty electrical power, a 100uF capacitor placed at the sensor pins between V+ and GND will typically correct the electrical noise.) Please reference page 12 for minimum operating voltage verses temperature information.

**GND Pin 7 – Sensor ground pin:** DC return, and circuit common ground.

### Package Types Currently Available

Full Horn – 3/4” NPT straight; back mounted thread

Snow Horn – 3/4” NPT straight; back mounted thread. Enhanced detection of snow.

All package types have exposed PCB on user end for easy connection. Users desiring a fully enclosed assembly may purchase the “Shielded Cable Option” along with their sensor.

## Sensor Mounting

It is recommended that several factors be taken into account when using the HRXL-MaxSonar-WRS ultrasonic snow depth sensors.

Due to the high gain of the sensor, the first recommendation is to mount the sensor far enough away from any supporting masts or towers. For a mast that is 5 meters high (or higher) the sensor should be mounted at least 100cm away from the mast. For a mast that is 2.5 meters high (or lower) the sensor should be at least 75cm away from the mast. (This corresponds to a mounting clearance angle of  $\geq 11.3$  degrees)

For users desiring the highest accuracy, it is recommended to use a properly mounted external temperature sensor.

MaxBotix Inc., is developing several components to assist in high accuracy readings and protection of the HRXL-MaxSonar-WRS and HR-MaxTemp sensors.

The first component is a shroud that is assembled over the top of the HRXL-MaxSonar-WRS sensor housing, Figure 1. This shroud is a UV shield for the sensor. The shroud is also acts to protect the sensor from hail, heavy snow, and snow build up.

The second component is a louver design housing to protect the temperature sensor from direct and reflective UV rays, Figure 2. This housing has been created to maintain a real time accurate temperature. This component is separate from the shroud that covers the HRXL-MaxSonar-WRS.

The third component is a fan housing which is able to hold either an AC or DC cooling fan under the temperature housing, Figure 3. This has been created for maximum airflow to the temperature sensor housing. The fan housing helps to ensure the temperature sensor is the same temperature as the surrounding environment.

All the components listed above are designed with the intent to use standard hardware for mounting to new or existing weather stations or other mounting components.

Figure 4 shows the recommended mounting for the HRXL-MaxSonar-WRS snow depth sensor with the HR-MaxTemp temperature sensor.

Mounting information for the snow sensor can be found in the application note here: [www.maxbotix.com/articles/070.htm](http://www.maxbotix.com/articles/070.htm)



Figure 1



Figure 2



Figure 3

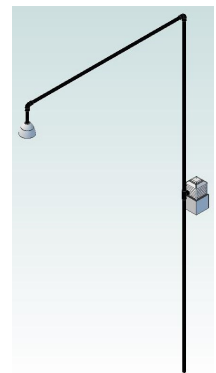

Figure 4

## Model Selection

Different applications require different sensors. MaxBotix Inc., has made a variety of snow and high sensitivity sensors available in order to best fit the broad range of potential applications. Users are encouraged to consider our other HRXL-MaxSonar-WR products for applications beyond snow.

Part Number	Serial Interface	Filter Reset Window	High Performance HR Filter <sup>1</sup>	Recommended Application	5 Meter Range
MB7334	RS232	2%	Yes	Water/Outdoors	Yes
MB7344	TTL	2%	Yes		Yes
MB7354	RS232	Never	Yes	Outdoors/Snow	Yes
MB7364	RS232	N/A	Yes	Any	Yes
MB7374	TTL	Never	Yes	Outdoors/Snow	Yes
MB7384	TTL	N/A	Yes	Any	Yes

For this product series the MB7364 and MB7384 constitute the base model. The MB7364 and MB7384 differ only in the serial output provided. The MB7364 has 0-Vcc RS232 serial data (inverted data that can be fed directly into a computer equipped with a DB9 port), and the MB7384 has TTL serial data.

The MB7354 and MB7374 have an additional filter on the data output for use in outdoor applications with stationary or slow moving targets. This filter has been shown to improve sensor accuracy and usability in snow depth monitoring applications and will allow the user to get consistent data even if the user only uses one reading to measure distance. In order for this filter to run the sensor must be operated in free-run mode.

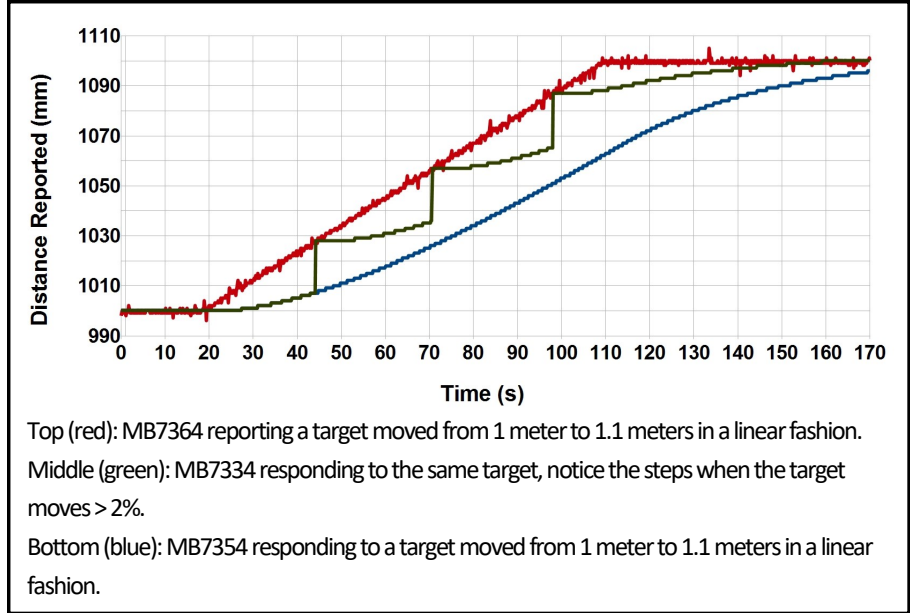

The MB7334 and MB7344 have an additional filter similar to the MB7354 and MB7374 except that the filter will reset to targets that are considered valid outside of a 2% distance to target window. This makes the sensor an ideal balance for accurately monitoring slow or stationary targets that occasionally move rapidly.

## Auto Calibration

Each time a HRXL-MaxSonar-WRS series sensor takes a range reading, it calibrates itself. The sensor then uses this data to range objects. If the temperature, humidity, or applied voltage changes during sensor operation, the sensor will continue to function normally over the rated temperature range while applying compensation for changes caused by temperature and voltage.

## Target Size Compensation

Most low cost ultrasonic rangefinders will report the range to smaller size targets as farther than the actual distance. In addition, they may also report the range to larger size targets as closer than the actual distance.

The HRXL-MaxSonar-WRS sensor line compensates for target size differences. This means that, provided an object is large enough to be detected, the sensor will report the same distance, typically within 1%, regardless of target size. Smaller targets can have additional detection noise that may limit this feature. In addition, targets with small or rounded surfaces may have an apparent distance that is slightly farther, where the distance reported may be a composite of the sensed object(s). Compensation for target size is applied to all range outputs: pulse width, analog voltage, and serial format output by the sensor.

## Sensor operation from 30-cm to 50-cm

Because of acoustic effects in the near field, objects between 30-cm and 50-cm may experience acoustic phase cancellation of the returning wave, resulting in inaccuracies of up to 5-mm. These effects become less prevalent as the target distance increases, and have not been observed past 50-cm. For this reason, users that require the highest accuracy are encouraged to mount the HRXL-MaxSonar-WRS farther than 50-cm away from objects.

### MB7334, MB7344 Filter – 2% distance to target filter

The MB7334 and MB7344 have a 2% distance to target filter designed to provide more accurate information in real-world environments. This filter improves sensor accuracy and stability by reducing the influence of wind, acoustic noise, thermal pockets, and other effects on the sensor output. (This is in addition to the HR filtering already available on the MB7364 and MB7384)

This filter can be reset at any time by bringing pin 4 (RX) of the sensor low.

This filter is active whenever the RX pin is brought high, all readings within a 2% distance to target window, are collected and added to the output sent to the user using a recent biased exponential weighted average.

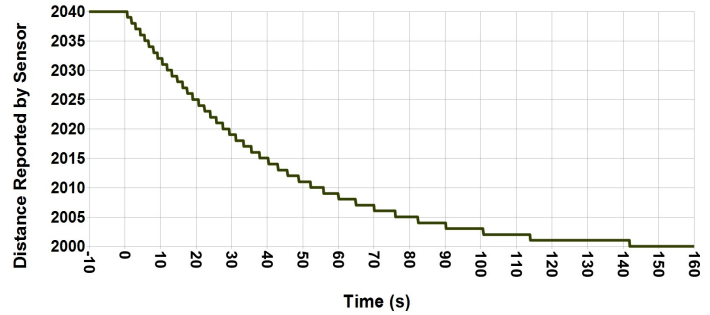

The MB7334 range output when responding to a 4cm change.

Confirmed readings outside of the 2% distance to target window will cause the filter to reset. This allows the sensor to continue functioning in a reasonable manner where high accuracy measurements are required for most of the sensor operation and quick sensor response is required at other points of operation.

### MB7354, MB7374 Filter

The MB7354 and MB7374 have a filter that improves sensor accuracy and stability by reducing the influence of wind, acoustic noise, thermal pockets and other effects on the sensor output. (This is in addition to the HR filtering already available on the MB7364 and MB7384.)

This filter can be reset at any time by bringing pin 4 (RX) of the sensor low.

This filter will initialize 40 readings (about 7 seconds) after sensor power is applied, or after the RX pin is brought high and held high.

This filter is a recent biased exponential weighted average filter that is also rate limited to change a maximum of seven mm per second taken and is designed to monitor stable, or slow moving objects, if a filter update is required this can be accomplished with the RX pin.

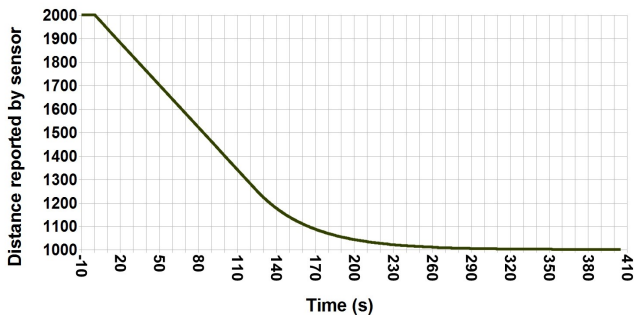

MB7354 responding to a 1 meter change. This shows the 7-mm rate limit along with the exponential filter.

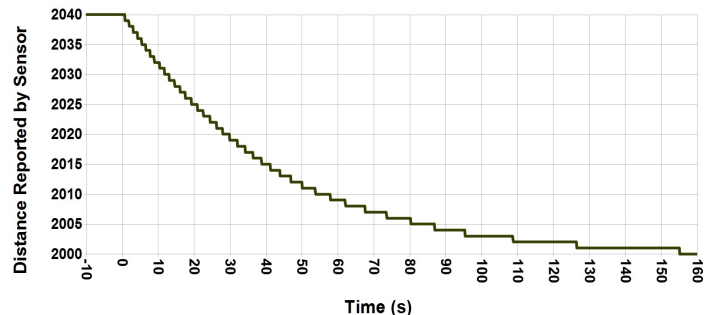

MB7354 responding to a 4 centimeter change. This shows the 7-mm rate limit along with the exponential filter.

## Sensor Performance Information

### Accuracy Information

Best accuracy during snow measurements is achieved when the air temperature is accurately measured midway between the sensor and the ground. To this end MaxBotix Inc., has tested our snow sensor solution using the internal temperature sensor, external temperature sensor and the external temperature sensor mounted in special Louvre housing with a fan.

Three million readings in each test configuration were then recorded over five days at our outside our facility with typical temperature swings of 15C per day and the MB7354 ranging to a stable target. All of the readings fell within the 1% tolerance in our test setup. The external temperature sensor, mounted with the special shield and fan, provided better performance.

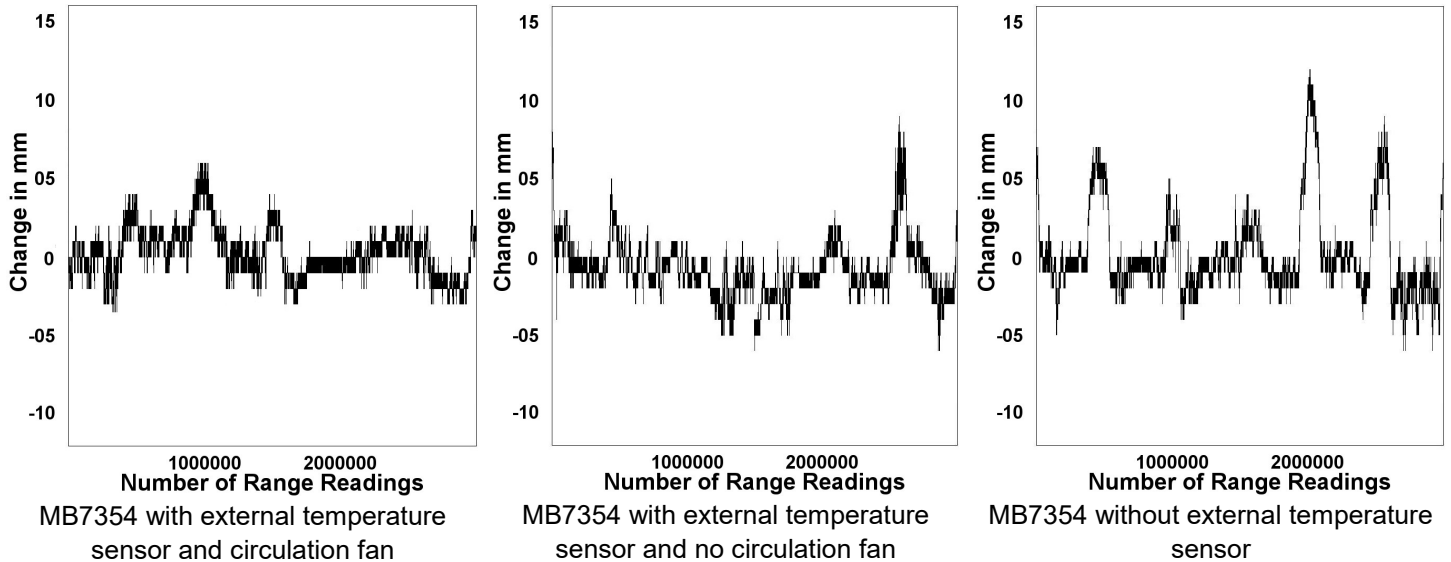

Below is a histogram, by quantity, of each reading observed.

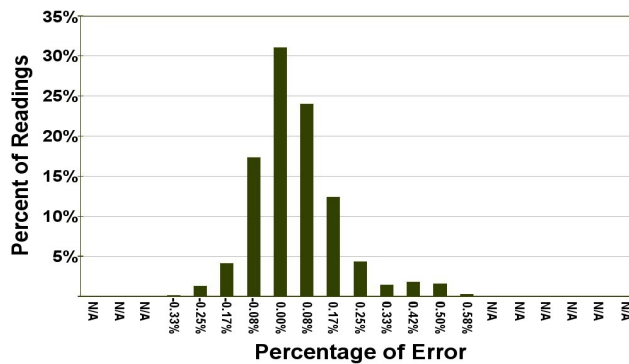

MB7354 with External Temperature Sensor and Fan

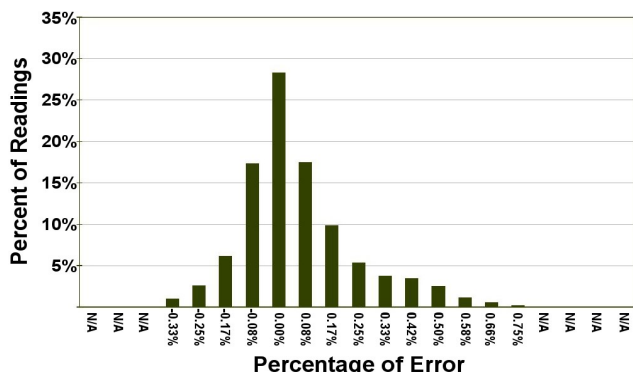

MB7354 with External Temperature Sensor

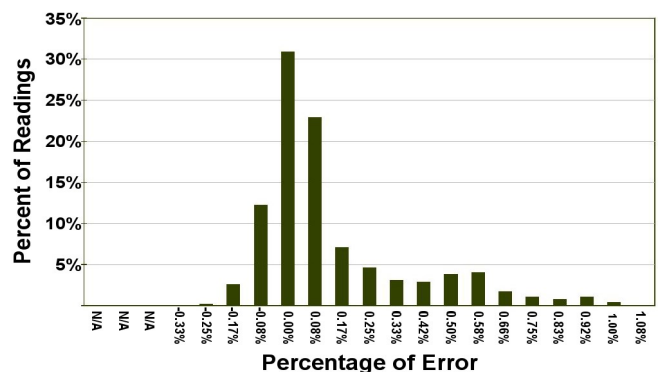

MB7354 without External Temperature Sensor

## Supply Voltage Compensation

During power up, the HRXL-MaxSonar-WRS sensors will calibrate itself for changes in supply voltage. Additionally, the sensor will compensate if the supplied voltage gradually changes.

If the average voltage applied to the sensor changes faster than 0.5V per second, it is best to remove and reapply power to the sensor.

For best operation, the sensor requires noise free power . If the sensor is used with noise on the supplied power or ground, the readings may be affected. Typically adding a 100uF capacitor at the sensor between the V+ and GND pins will correct most power related electrical noise issues.

## Sensor minimum distance

The HRXL-MaxSonar-WRS sensors have a minimum reported distance of 50-cm (19.7 inches). However, the HRXL-MaxSonar-WRS will report targets up to the sensor face. For the HRXL-MaxSonar-WRS sensors, targets closer than 500-mm will typically range as 500-mm.

## Range “0” location

The HRXL-MaxSonar-WR reports the range to distant targets from where the threading and nut meet on the sensor housing as shown in the diagram below.

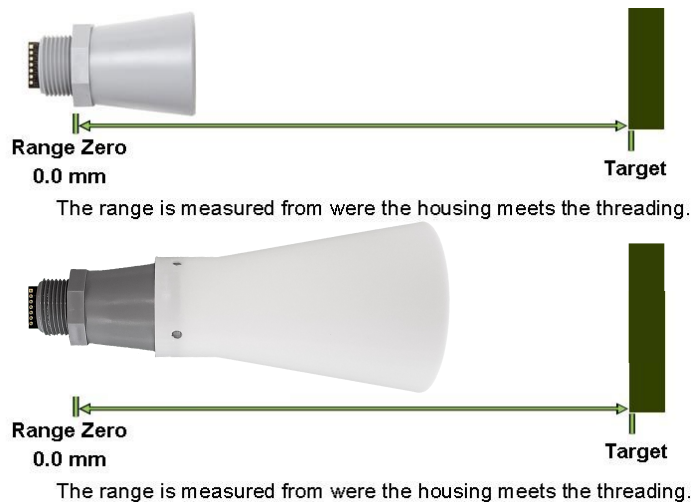

In general, the HRXL-MaxSonar-WR will report the range to the leading edge of the closest detectable object. Target detection has been characterized in the sensor beam patterns.

## HRXL-MaxSonar®-WR™ Temperature Compensation

### On Board – Internal Temperature Compensation

The speed of sound in air increases by about 0.6 meters per second, per degree centigrade. Because of this, each HRXL-MaxSonar-WR is equipped with an internal temperature sensor which allows the sensor to apply compensation for speed of sound changes.

The actual air temperature of the path between the sensor and the target may not match the temperature measured at the sensor itself. Sensors can be mounted in vertical applications, or applications where the environment temperature gradient is severe. These users may experience a temperature measurement error which will affect the sensor accuracy. For example, buildings with a height of 3-meters can have floor to ceiling temperature variations of 5°C or more.

Because of these temperature effects, users desiring the highest accuracy output are encouraged to use a properly mounted external temperature sensor or to manually account for this measurement error.

### HR-MaxTemp, an External Temperature Sensor

Although the HRXL-MaxSonar-WR has an internal temperature sensor; for best accuracy, users are encouraged to use the optional external temperature sensor. On power-up, the HRXL-MaxSonar-WR will automatically detect an attached HR-MaxTemp temperature sensor and begin to apply temperature compensation using the external temperature sensor.

The external temperature sensor allows for the most accurate temperature compensation, by allowing temperature readings to be taken that better reflect the composite temperature of the acoustic ranging path. For best results, users are encouraged to connect the temperature sensor midway between the HRXL-MaxSonar-WR and the expected target.



## HRXL-MaxSonar-WR Sensor Operating Modes

### Free-Run Operation

When operating in free run mode, the HRXL-MaxSonar-WRS sensors are designed to be used in a variety of outdoor, industrial, or indoor situations. Many acoustic noise sources will have little to no effect on the reported range of the HRXL-MaxSonar-WRS sensors. Most range readings are accurately reported. If the range readings are affected, the effect is typically less than 5-mm. This allows users to employ real-time ultrasonic distance sensing without the need for additional supporting circuitry or complicated user software.

Multiple HRXL-MaxSonar-WRS sensors can be operated in the same general locations. The internal noise filter is able to filter out the ultrasonic noise from other HRXL-MaxSonar-WRS sensors with minimal interference. Typically, when operating with multiple sensors, the range readings will be within  $\pm 1$  cm of the actual range to the intended target.

### Independent Sensor Operation

The HRXL-MaxSonar-WRS sensors have the capability to operate independently when the user desires. When using the HRXL-MaxSonar-WRS sensors in single or independent sensor operation, it is easiest to allow the sensor to free-run. Free-run is the default mode of operation for all of the MaxBotix Inc., sensors. The HRXL-MaxSonar-WRS sensors have three separate outputs that update the range data simultaneously: Analog Voltage, Pulse Width, and Serial Data. Below are diagrams on how to connect the sensor for each of the three outputs for single or independent sensor operation.

### Using Multiple Sensors in a Single System

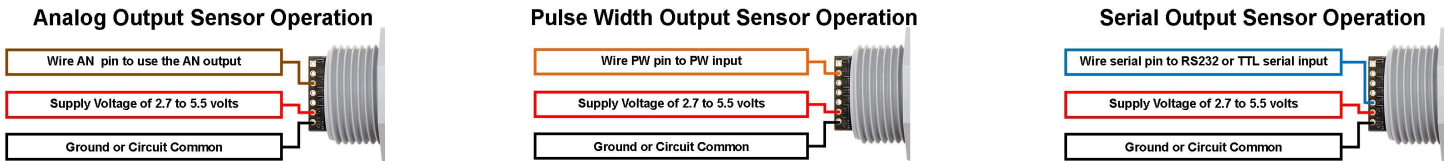

Multiple HRXL-MaxSonar-WRS sensors can be used simultaneously in the same environment with little to no interference (cross-talk). Even so, some cross-talk may still occur for users wishing to use a large number of sensors in the same environment.

If interference is occurring in the sensor setup please visit [www.maxbotix.com/chaining](http://www.maxbotix.com/chaining) for diagrams on correcting cross-talk between sensors.

Please take note that when the HRXL-MaxSonar-WRS sensors are operating in a chaining sequence the internal free-run filter of the sensor is disabled, and the sensor will range in real-time.

## Sensor Timing Diagrams

### Power Up Timing

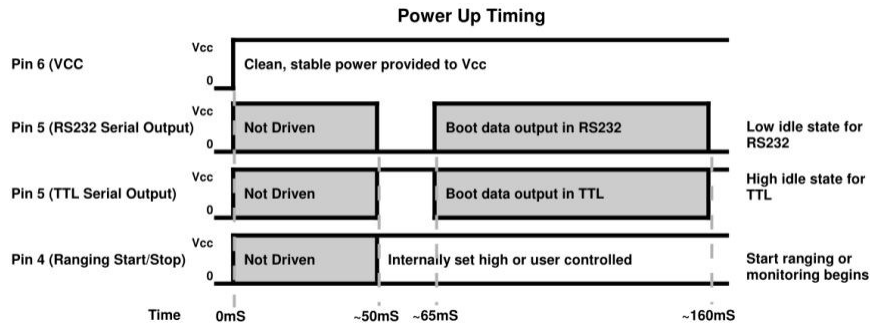

All parts have the same powerup timing.

### Sensor Free-Run Timing

When operating in free run mode, the HRXL-MaxSonar-WRS sensors are designed to be used in a variety of outdoor,

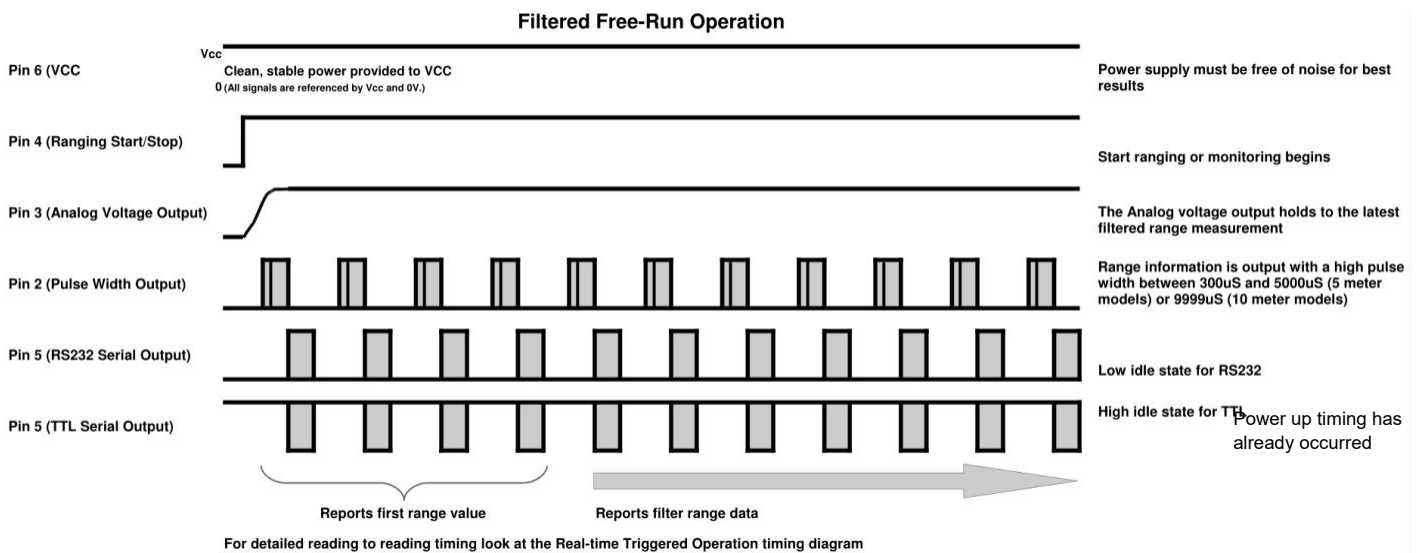

Product	Maximum Refresh Rate	Free Run Filter	Pulse Width Reported	Serial Data Reported	Pin 4 Brought Low	End of Range Cycle
MB7334, MB7344, MB7354, MB7364, MB7374, MB7384	6.67Hz	1.33Hz	~135mS	~140mS	~147mS	~148mS

industrial, or indoor environments. Many acoustic noise sources will have little to no effect on the reported range of the HRXL-MaxSonar-WRS sensors. Most range readings are accurately reported. If the range readings are affected, the effect is typically less than 5-mm. This allows users to employ real-time ultrasonic distance sensing without the need for additional supporting circuitry or complicated user software.

The HRXL-MaxSonar-WRS use an internal filter to process range data. This filter improves the sensor’s performance for accuracy, noise rejection, and reading to reading stability. The filtering in the free-run operation also permits additional acoustic and electrical noise tolerance.

On the HRXL-MaxSonar-WRS sensors, when pin 4 is left high, the sensor will continue to range, the data output includes a filter for increased accuracy in environments with acoustic noise. The HRXL-MaxSonar-WRS sensors will output the range based on recent range information. The filter does not affect the speed at which data is made available to the user but instead allows for more consistent range information to be presented.

## Sensor Timing Diagrams Cont.

### Triggered—Real-time Operation Timing

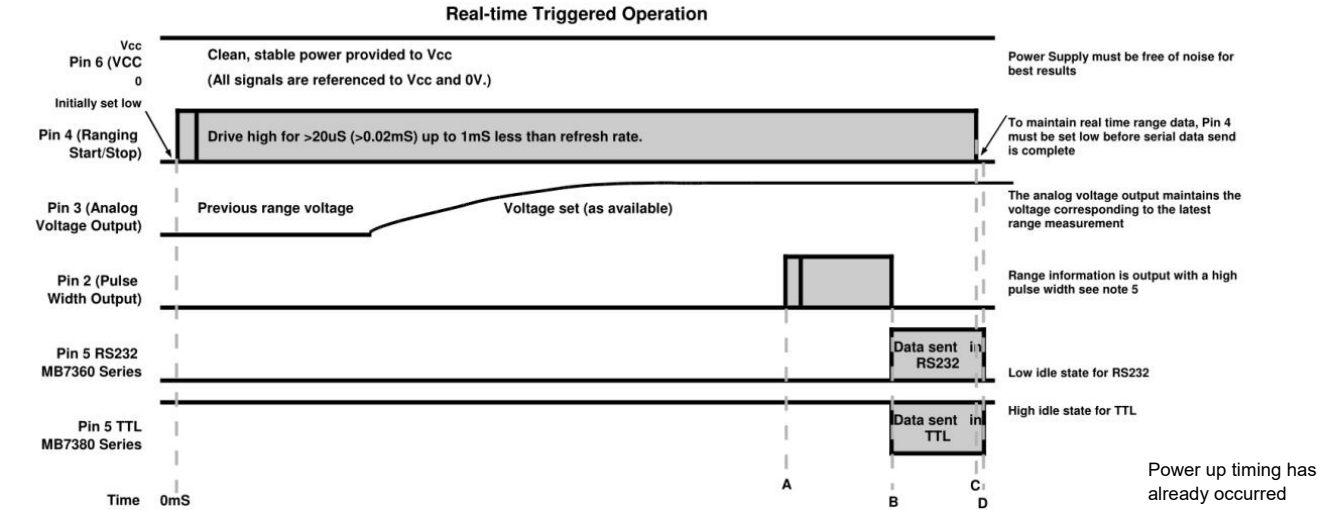

Product	Maximum Refresh Rate	Pulse Width sent (A)	Serial Data sent (B)	RX Pin set low (C)	End of range cycle (D)
MB7334, MB7344, MB7354, MB7364, MB7374, MB7384	6.67Hz	~135mS	~140mS	~147mS	~148mS

Real-time or triggered operation allows users to take advantage of a few functions unavailable during free run mode. When operating in triggered mode, an unfiltered maximum refresh rate can be achieved. This triggered operation allows users to range targets moving away from or closer to the sensor faster than 240mm per reading.

Users can enter and remain in the real-time or triggered operation by making sure that before the end each range cycle, the voltage level on Pin 4 is set low. After the sensor has completed the last reading, then Pin 4 is brought high. When Pin 4 is brought high, a brand new range cycle starts and the HRXL-MaxSonar-WR will output the most recent range data without filtering.

Readings during triggered operation are less accurate than the filtered operation by approximately ±5-mm. Because the range readings are not filtered, noise tolerance can be greatly reduced. Care should be taken to make sure that only one sensor is sampling range at a time.

**Pulse Width data sent (Column A)** - Column A shows the approximate time that the sensor starts to output the pulse width data. The Pulse Width output time can be as short as 300µS (minimum reported distance). For 5 meter sensors, the pulse width can take as long as 5000µS (maximum reported distance) to be sent. For 10 meter sensors the Pulse Width can take as long as 9999µS (maximum reported distance) to be sent.

**Serial data sent (Column B)** - Column B shows the approximate time during each range cycle when the serial data is output for the sensor. Range data takes ~8mS to be reported from the serial data output.

**RX Pin set low (Column C)** - When operating the HRXL-MaxSonar-WR in Triggered Operation, Pin 4 is must be brought high for a time frame greater than 20µS (0.02mS) and less than the time in Column C in the chart above. If Pin 4 remains high for a period of time greater than the value in Column C, the sensor will switch into free-run filter operation.

**End of Range Cycle (Column D)** - Column D shows the approximate time each range cycle takes to complete for each sensor.

## Voltage vs Temperature

The graph below shows minimum operating voltage of the sensor verses temperature.

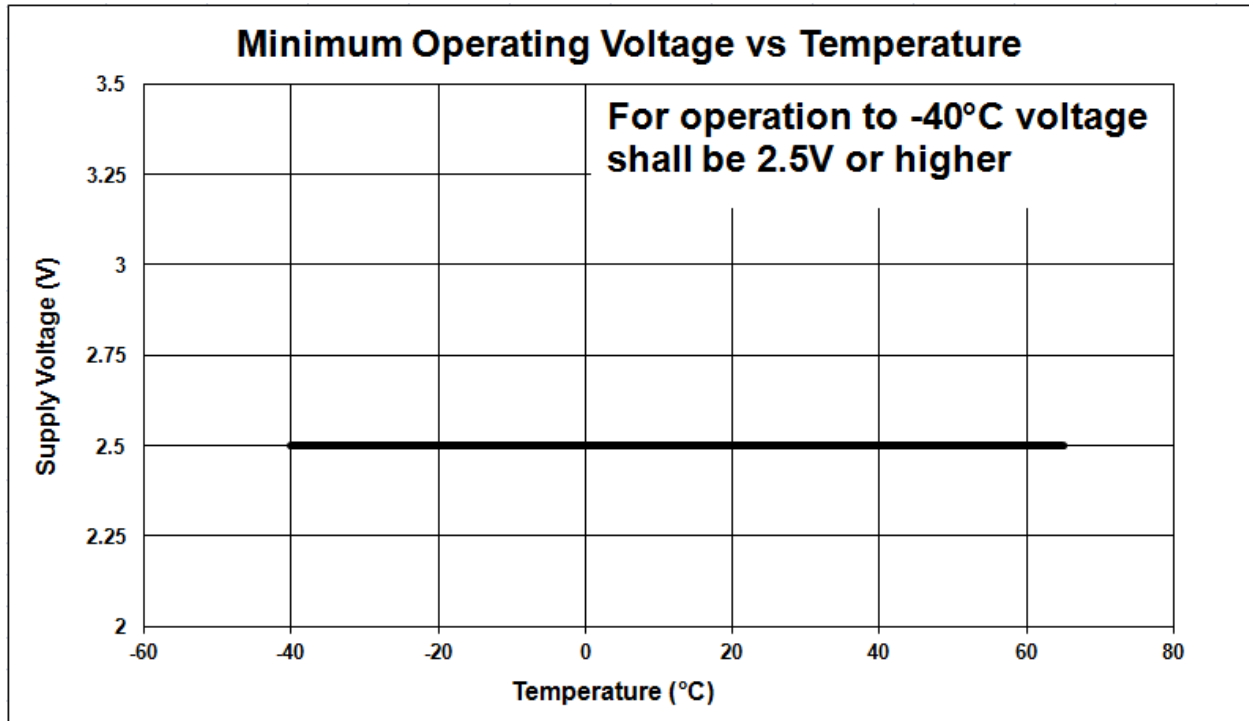

## HRXL-MaxSonar®-WR™ Beam Patterns

### Attenuation of Ultrasound

Attenuation, specifically absorption of sound through the air, restricts the maximum range of ultrasonic rangefinders. As sound waves travel through the air, that air absorbs some of their energy. High frequency sounds like ultrasound are often attenuated more quickly than lower frequency sounds. In addition to frequency, relative humidity also affect attenuation. Warm air masses with low relative humidity will typically attenuate sound waves faster. As such performance of ultrasonic devices may be limited at low relative humidity, especially when trying to detect targets at longer ranges.

### Background Information Regarding our Beam Patterns

Each HRXL-MaxSonar-WR sensor has a calibrated beam pattern. Each sensor is matched to provide the approximate detection pattern shown in this datasheet. This allows end users to select the part number that matches their given sensing application. Each part number has a consistent field of detection so additional units of the same part number will have similar beam patterns. The beam plots are provided to help identify an estimated detection zone for an application based on the acoustic properties of a target versus the plotted beam patterns.

Each beam pattern is a 2D representation of the detection area of the sensor. The beam pattern is actually shaped like a 3D cone (having the same pattern both vertically and horizontally). Beam patterns for dowels are used to show the beam pattern of each sensor. Dowels are long cylindrical targets of a given diameter. The dowels provide consistent target **detection** characteristics for a given size target which allows easy comparison of one MaxSonar sensor to another MaxSonar sensor.

For each part number, the four patterns (A, B, C, and D) represent the detection zone for a given target size. Each beam pattern shown is determined by the sensor's part number and target size.

**People Sensing:**  
 For users that desire to detect people, the detection area to the 1-inch diameter dowel, in general, represents the area that the sensor will reliably detect people.

The actual beam angle changes over the full range. Use the beam pattern for a specific target at any given distance to calculate the beam angle for that target at the specific distance. Generally, smaller targets are detected over a narrower beam angle and a shorter distance. Larger targets are detected over a wider beam angle and a longer distance.

### Beam Pattern Target Shapes

- A 6.1-mm (0.25-inch) diameter dowel 4ft length
- B 2.54-cm (1-inch) diameter dowel 4ft length
- C 8.89-cm (3.5-inch) diameter dowel 4ft length
- D 11-inch wide board 4ft in length moved left to right with the board parallel to the front sensor face. This shows the sensor's range capability.

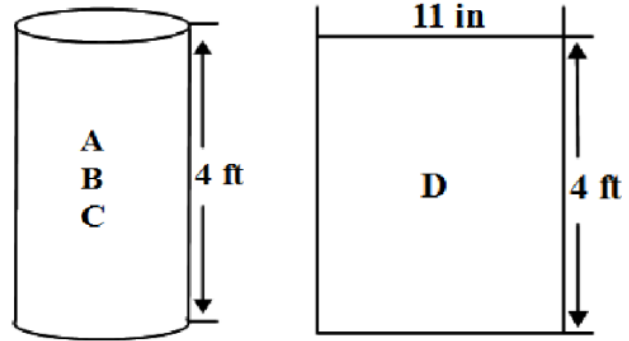

### Corner Reflectors

Sometimes when using an ultrasonic sensor, users experience detection of unwanted objects that appear outside the expected beam pattern. These types of detections are the result of reflectors present in the environment. Corner reflectors can be surprisingly small, yet present a large reflection back to the sensor. Certain objects are prone to causing corner reflections. One of the most common corner reflectors is two flat surfaces joining together to create a 90° angle. A half-circle also acts as a similar reflector. You can learn more about corner reflectors in our [Cube Corner Reflectors](#) article.

# MB7334-MB7344 HRXL-MaxSonar® -WRS™ Beam Pattern and Uses

The HRXL-MaxSonar-WRS is a low-cost, rugged ultrasonic snow depth sensor that is optimized for reliable snow depth measurement. Sensor readings are optimized for snow measurement, ensuring accurate snow depth measurement

## MB7334-1XX MB7344-1XX MB7334-8XX MB7344-8XX HRXL-MaxSonar® -WRS/WRST™ Beam Pattern

Sample results for measured beam pattern are shown on a 30-cm grid. The detection pattern is shown for dowels of varying diameters that are placed in front of the sensor.

A 6.1-mm (0.25-inch) diameter dowel

B 2.54-cm (1-inch) diameter dowel

C 8.89-cm (3.5-inch) diameter dowel

D 11-inch wide board moved left to right with the board parallel to the front sensor face. This shows the sensor's range capability.

**Note:** For people detection the pattern typically falls between charts A and B.

Partial Detection

5.0 V

3.3 V

2.7 V

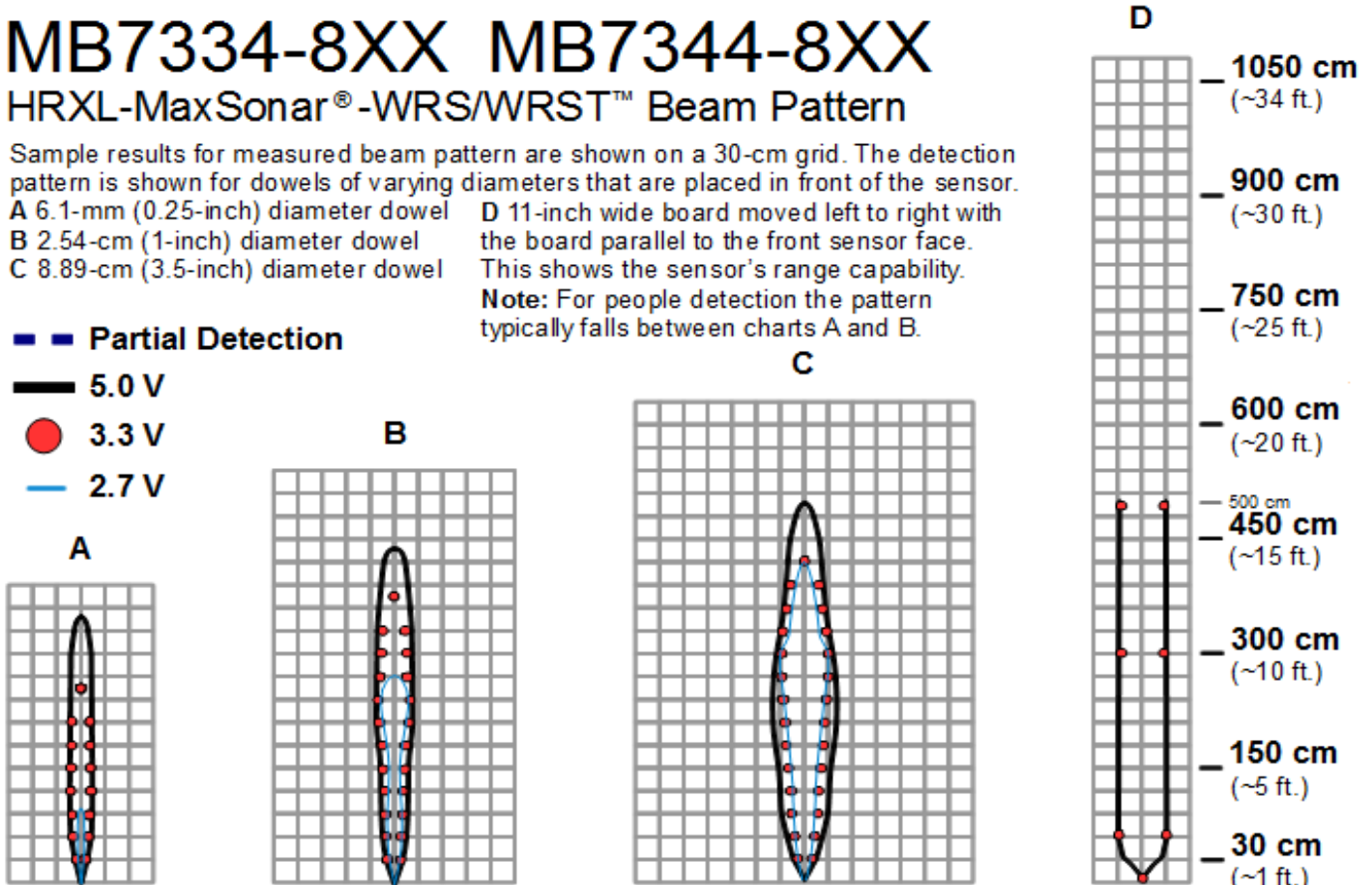

**Beam Characteristics are Approximate**

Beam Pattern drawn to a 1:95 scale for easy comparison to our other products.

### Features and Benefits

- Factory calibrated beam width
- All range outputs are active simultaneously
- High acoustic sensitivity

### Applications and Uses

- Snow depth measurement
- Weather station monitoring
- Soft target detection
- Water
- Outdoors applications

# MB7354-MB7374 HRXL-MaxSonar® -WRS™ Beam Pattern and Uses

The HRXL-MaxSonar-WRS is a low-cost, rugged ultrasonic snow depth sensor that is optimized for reliable snow depth measurement. Sensor readings are optimized for snow measurement, ensuring accurate snow depth measurement

## MB7354-1XX MB7374-1XX MB7354-8XX MB7374-8XX HRXL-MaxSonar® -WRS/WRST™ Beam Pattern

Sample results for measured beam pattern are shown on a 30-cm grid. The detection pattern is shown for dowels of varying diameters that are placed in front of the sensor.

- A 6.1-mm (0.25-inch) diameter dowel
- B 2.54-cm (1-inch) diameter dowel
- C 8.89-cm (3.5-inch) diameter dowel

D 11-inch wide board moved left to right with the board parallel to the front sensor face. This shows the sensor's range capability.  
**Note:** For people detection the pattern typically falls between charts A and B.

- Partial Detection
- 5.0 V
- 3.3 V
- 2.7 V

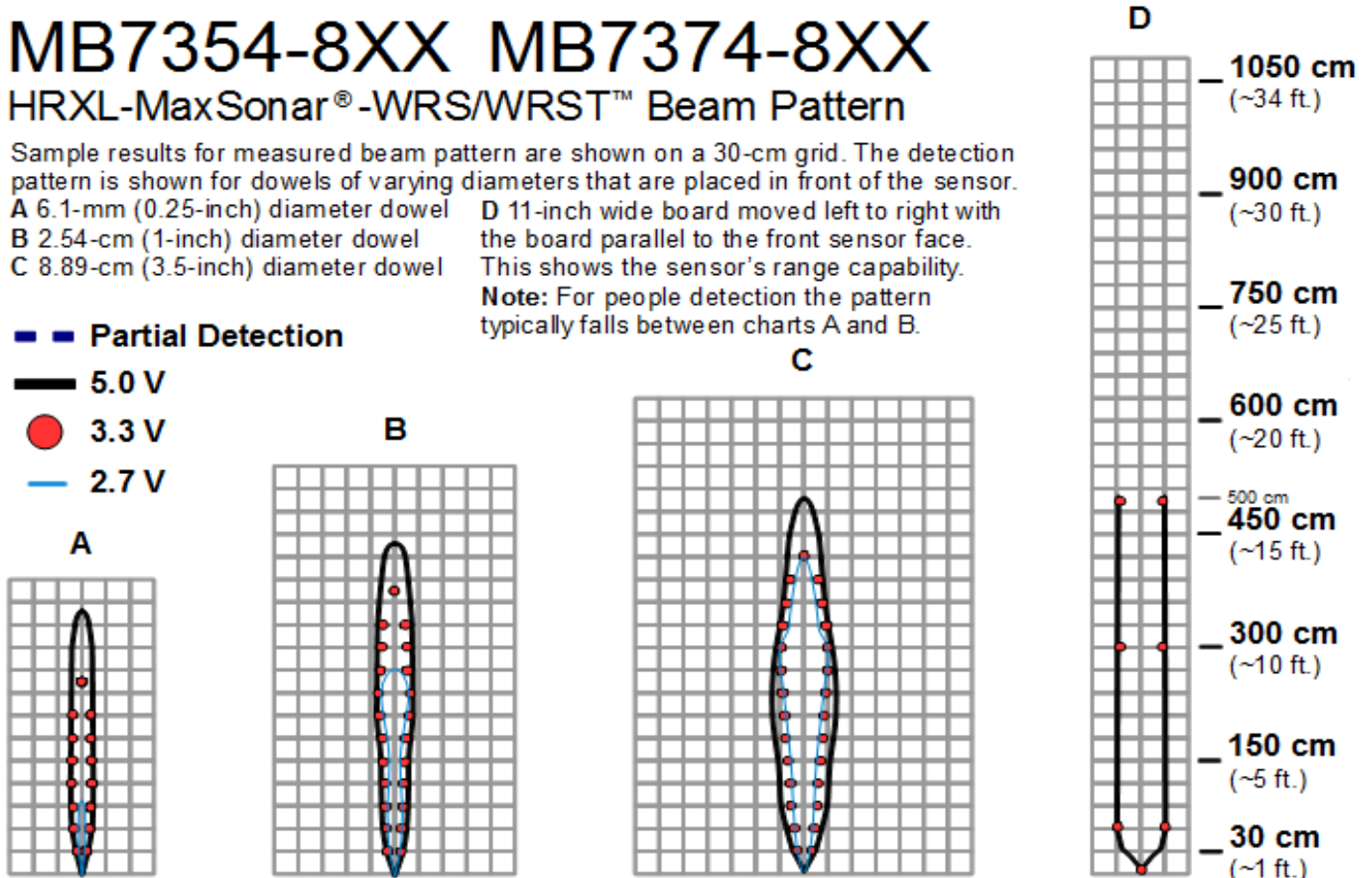

**Beam Characteristics are Approximate**

Beam Pattern drawn to a 1:95 scale for easy comparison to our other products.

### Features and Benefits

- Factory calibrated beam width
- All range outputs are active simultaneously
- High acoustic sensitivity

### Applications and Uses

- Snow depth measurement
- Weather station monitoring
- Soft target detection

# MB7364-MB7384 HRXL-MaxSonar® -WRS™ Beam Pattern and Uses

The HRXL-MaxSonar-WRS is a low-cost, rugged ultrasonic snow depth sensor that is optimized for reliable snow depth measurement. Sensor readings are optimized for snow measurement, ensuring accurate snow depth measurement

## MB7364-1XX MB7384-1XX MB7364-8XX MB7384-8XX HRXL-MaxSonar® -WRS/WRST™ Beam Pattern

Sample results for measured beam pattern are shown on a 30-cm grid. The detection pattern is shown for dowels of varying diameters that are placed in front of the sensor.

- A 6.1-mm (0.25-inch) diameter dowel
- B 2.54-cm (1-inch) diameter dowel
- C 8.89-cm (3.5-inch) diameter dowel

D 11-inch wide board moved left to right with the board parallel to the front sensor face. This shows the sensor's range capability.

**Note:** For people detection the pattern typically falls between charts A and B.

- Partial Detection
- 5.0 V
- 3.3 V
- 2.7 V

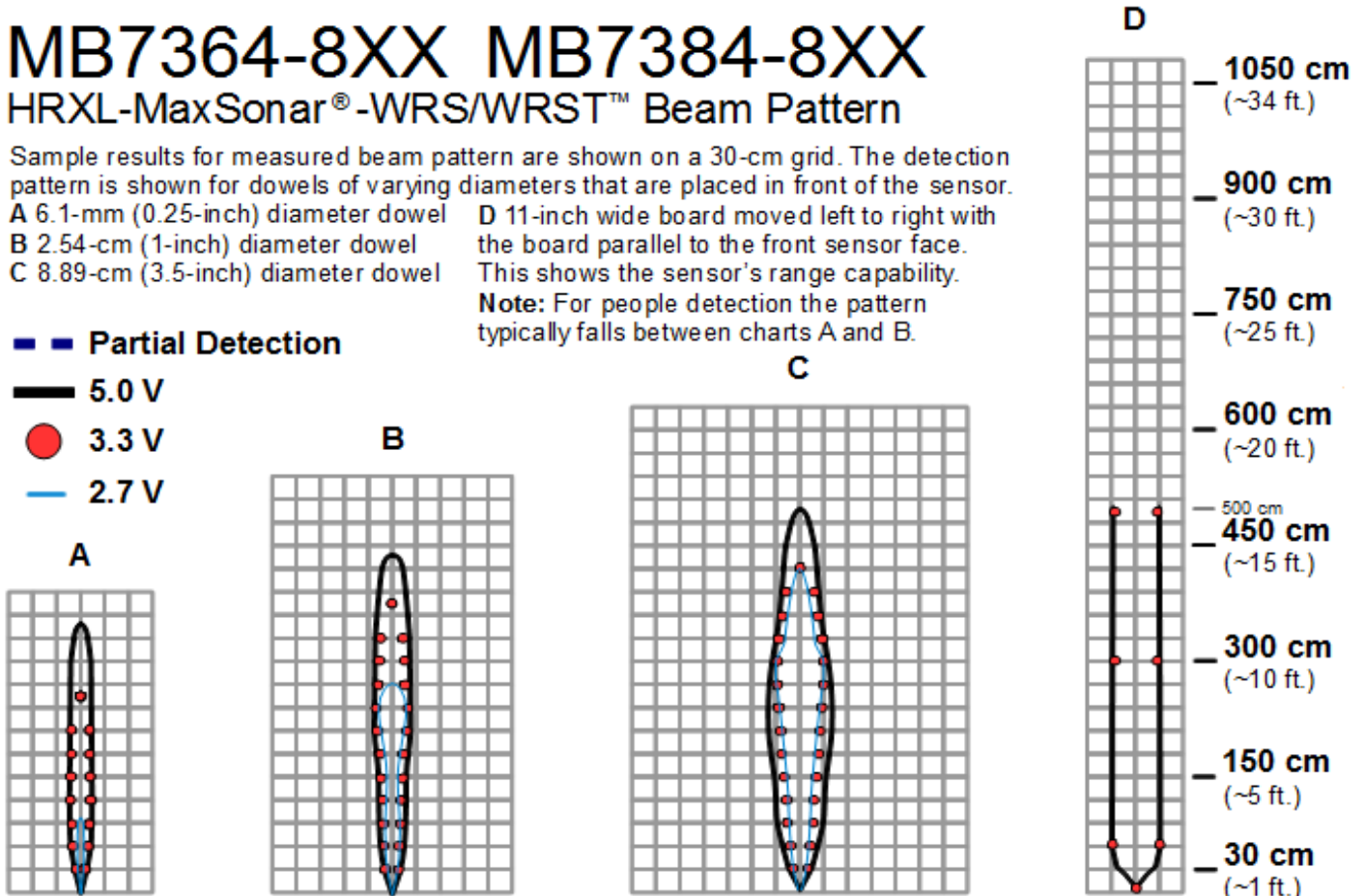

**Beam Characteristics are Approximate**

Beam Pattern drawn to a 1:95 scale for easy comparison on to our other products.

### Features and Benefits

- Factory calibrated beam width
- All range outputs are active simultaneously
- High acoustic sensitivity

### Applications and Uses

- Snow depth measurement
- Weather station monitoring
- Soft target detection



## Part Numbers

All part numbers are a combination of a six-character base followed by a dash and a three-digit product code. Please review the following table for more information on the three-digit product code.

Note: Active part numbers listed on page 18.

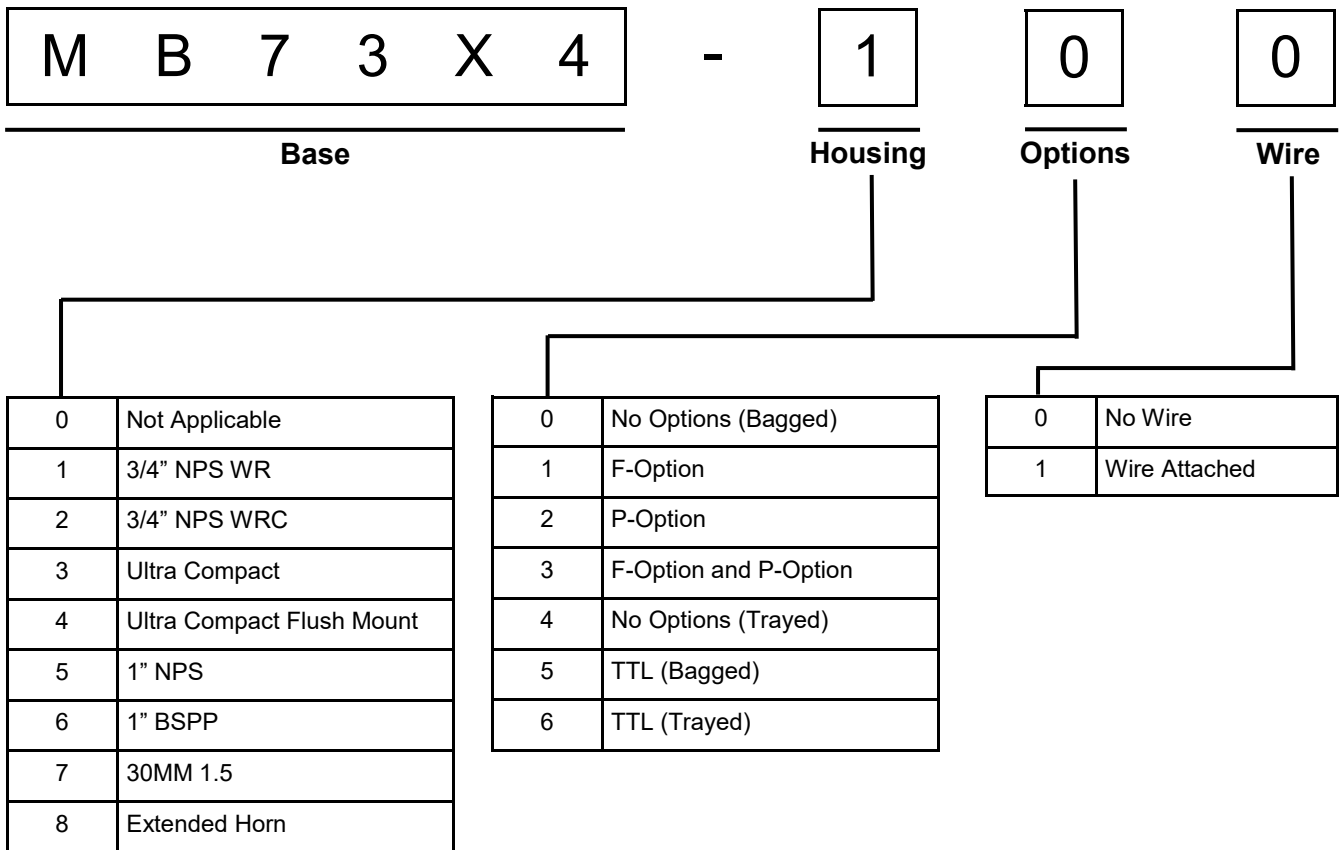

The following tables display all of the active and valid part numbers for these products.

Active Part Numbers for MB7334							
MB7334-100	MB7334-101	MB7334-110	MB7334-111	MB7334-120	MB7334-121	MB7334-130	MB7334-131
MB7334-800	MB7334-801	MB7334-810	MB7334-811	MB7334-820	MB7334-821	MB7334-830	MB7334-831

Active Part Numbers for MB7344							
MB7344-100	MB7344-101	MB7344-110	MB7344-111	MB7344-120	MB7344-121	MB7344-130	MB7344-131
MB7344-800	MB7344-801	MB7344-810	MB7344-811	MB7344-820	MB7344-821	MB7344-830	MB7344-831

Active Part Numbers for MB7354							
MB7354-100	MB7354-101	MB7354-110	MB7354-111	MB7354-120	MB7354-121	MB7354-130	MB7354-131
MB7354-800	MB7354-801	MB7354-810	MB7354-811	MB7354-820	MB7354-821	MB7354-830	MB7354-831

Active Part Numbers for MB7364							
MB7364-100	MB7364-101	MB7364-110	MB7364-111	MB7364-120	MB7364-121	MB7364-130	MB7364-131
MB7364-800	MB7364-801	MB7364-810	MB7364-811	MB7364-820	MB7364-821	MB7364-830	MB7364-831

Active Part Numbers for MB7374							
MB7374-100	MB7374-101	MB7374-110	MB7374-111	MB7374-120	MB7374-121	MB7374-130	MB7374-131
MB7374-800	MB7374-801	MB7374-810	MB7374-811	MB7374-820	MB7374-821	MB7374-830	MB7374-831

Active Part Numbers for MB7384							
MB7384-100	MB7384-101	MB7384-110	MB7384-111	MB7384-120	MB7384-121	MB7384-130	MB7384-131
MB7384-800	MB7384-801	MB7384-810	MB7384-811	MB7384-820	MB7384-821	MB7384-830	MB7384-831

---

## After reviewing this datasheet, do you have any more questions?

We offer Technical Support on all of our products even if you purchased them through one of our many vendors worldwide.

You can fill out a **Technical Support form** for assistance on a sensor here --> [Technical Support](#)

## Not sure which sensor you need for your application?

We offer Sensor Selection Assistance, click the link here to fill out a form for support --> [Sensor Selection Help](#)

## Looking for tutorials to help you get started?

### [Frequently Asked Questions about Our Sensors](#)

We receive many questions about our products and services. This resource offers answers to common inquiries we receive about our product lines and their application.

### [Fully Calibrated Beam Patterns](#)

All of our sensors are factory calibrated to provide consistent beam patterns, detection zones, to fit into a wide variety of applications. In our product lines, each model number comes with a different beam pattern that reflects the sensitivity and the detection zone of how it sees a target. Additionally, we strive to maintain consistency between our finished products, and you will see little to no deviation between sensors of the same model. This allows you to have confidence in your final application when using multiple sensors.

### [Understanding Range Readings](#)

The success of an application may hinge upon knowing the exact location of a target. However, a sensor may report one meter even if the target is not exactly one meter away from the sensor. Sensor specifications, such as resolution, precision, and accuracy, help you to understand sensor performance.

### [How to Use Multiple Ultrasonic Sensors](#)

This guide covers three ways to run your sensors in a Multiple Sensor environment and issues you may face.

Contact us now with any questions at [sales@maxbotix.com](mailto:sales@maxbotix.com) or call +1-218-454-0766.

Please call during our preferred business hours of 8:00 am – 4:30 pm EST on Monday through Thursday and 8:00 am – 2:00 pm EST on Friday, or you may leave us a voicemail anytime.