

Standards-based cylinders DSBC, ISO 15552

FESTO



Festo Core Range
Solves the majority of your automation tasks

Worldwide: Quickest delivery – wherever, whenever
Simply good: Expected high Festo quality
Fast: Easy and fast to select

With the Festo Core Range, we have selected the most important products and functions from our broad product catalogue, and added the quickest delivery.

The Core Range offers you the best value for your automation tasks.

Just look
for the
star!

Characteristics

At a glance



- Standards-based cylinders to ISO15552 (corresponds to the withdrawn standards ISO 6431, DIN ISO 6431, VDMA24562, NFE49003.1 and UNI 10290)

- Double-acting
- For contactless position sensing
- Optionally with protection against rotation
- EX4: for use in potentially explosive areas
- Extensive range of accessories makes it possible to install the cylinder virtually anywhere
- Three types of cushioning available:
 - Elastic cushioning: elastic cushioning rings/plates at both ends
 - PPS cushioning: pneumatic cushioning, self-adjusting at both ends
 - PPV cushioning: pneumatic cushioning, adjustable at both ends
- The variants can be configured according to individual needs using a modular product system
- Wide range of variants provides high level of flexibility

DSBC-...-C – with clamping unit, standard hole pattern

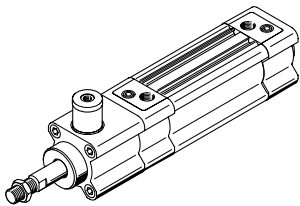

- Standard hole pattern
- Piston rod can be held or clamped in any position
- The piston rod can be held in position for long periods even with alternating loads, fluctuating operating pressure or leaks in the system

Additional measures are required for use in safety-related applications; in Europe, for example, the standards listed under the EC Machinery Directive must be observed.

Without additional measures in accordance with legally specified minimum requirements, the product is not suitable as a safety relevant component in control systems.

DSBC-...-E1/-E2/-E3 – with end-position locking, standard hole pattern

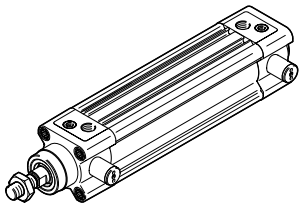

- Standard hole pattern
- Positive locking in the end position as a drop guard. In the event of a pressure drop, the piston rod is locked in its end position.
- Optionally at one or both ends

Additional measures are required for use in safety-related applications; in Europe, for example, the standards listed under the EC Machinery Directive must be observed.

Without additional measures in accordance with legally specified minimum requirements, the product is not suitable as a safety relevant component in control systems.

DSBC-...-P2 – with bellows kit DADB, standard hole pattern

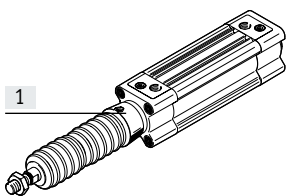

The bellows protects the piston rod, the seal and the bearing from the effects of a wide range of media, which has a positive impact on the service life of these components.

The bellows kit is a leak-free system. To prevent unwanted media from being drawn in, the supply and exhaust air for the kit must be ducted via a pressure compensation hole in the connection part [1].

The kit protects the piston rod, seal and bearing against a wide variety of media, for example:

- Dust
- Chippings
- Oil
- Grease
- Fuel

Ordering the bellows kit

An extended piston rod is absolutely essential if a bellows kit is to be used. The bellows kit can be ordered via the modular product system or as an accessory. The following must be noted in this case:

Ordering via the modular product system:

The bellows kit is supplied mounted on the bearing cap using feature P2. The required piston rod extension is automatically taken into consideration. This means that there is no need to specify a value for feature ...E.

Ordering as an accessory:

If the bellows kit is ordered as an accessory, the required value → page 51 must be entered for feature ...E in the modular product system.

Characteristics

DSBC... D3 – Sensor slots on 3 sides

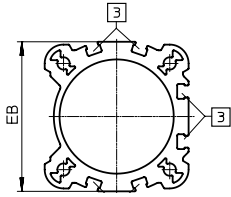

The piston position can be sensed on 3 sides of the drive if feature D3 is selected in the modular product system.

[3] Sensor slot for proximity switch

Position sensing/force control

With position transmitter SMAT-8M, SMAT-8E, SDAT → page 61



Analogue position feedback possible

- Analogue output
 - 0 ... 10 V
 - 0 ... 20 mA

With proportional-pressure regulator VPPM



Infinite adjustment of the gripping force possible

- Setpoint value input
 - 0 ... 10 V
 - 4 ... 20 mA

For manufacturing lithium-ion batteries

DSBC...-F1A

Recommended for production plants for manufacturing lithium-ion batteries ($Cu < 1\%$, $Zn < 1\%$, $Ni < 1\%$).

Metals with copper, zinc or nickel as the main constituent are excluded from use. Exceptions are nickel in steels, chemically nickel-plated surfaces, printed circuit boards, cables, electrical plug connectors and coils.

Accessories

Your Festo contact partner can provide information about which accessories are suitable for manufacturing lithium-ion batteries.

Optional accessories

Mounting kit DAVM

→ Page 1

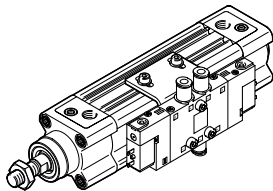

- For lateral valve mounting, directly on the drive
- Particularly suitable for decentralised use in large systems
- Mounting is only possible on the side on which the pneumatic connections are located

Application examples



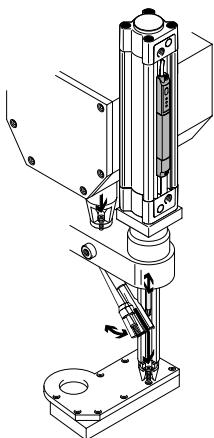



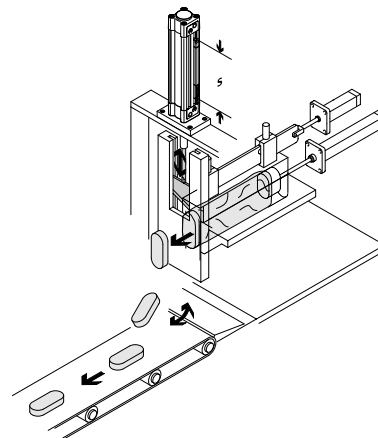

Automatic screw machine





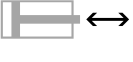





For process control

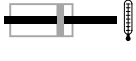

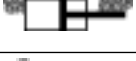
Characteristics

| Variants from the modular product system | | |
|--|---|---|
| Symbol | Characteristics | Description |
|  | Q Square piston rod | Protection against rotation. For correctly oriented feeding |
|  | C Clamping unit | Integrated clamping unit on the piston rod |
|  | E1/E2/E3 End-position locking | Positive locking in the end position as a drop guard. If there is a drop in pressure, the piston rod is secured in its end position to prevent it from dropping |
|  | L Low friction | <ul style="list-style-type: none"> • Break-away pressure: low • Dynamic response: suitable for very fast movements, especially at low operating pressures • Resistance: minimal resistance during movement, maximum stick-slip Application example: very dynamic movements with no standstill <ul style="list-style-type: none"> • Suitable for applications that require dynamic movement • Efficient at speeds above 50 mm/s |
|  | U Constant, slow movement | <ul style="list-style-type: none"> • Break-away pressure: very low • Dynamic response: Suitable for very slow, constant and stick-slip-free movements • Resistance: strong resistance during movement, minimal stick-slip Application example: slow, constant feed motion <ul style="list-style-type: none"> • Suitable for slow movements at a constant speed over the stroke range |
|  | L1 Low friction for balancer applications | <ul style="list-style-type: none"> • Break-away pressure: low • Dynamic response: Suitable for slow movements with constant application of pressure at one end. System friction is independent of operating pressure • Resistance: low, constant during movement Application example: applications for balancing of masses (balancer, belt tensioner with constant feed motion) <ul style="list-style-type: none"> • The resistance is constant and low, regardless of the working pressure • Upward and downward movements as well as fast/slow movements always need the same, low force |
|  | T Through piston rod | For working at both ends with the same force in the forward and return stroke, for attaching external stops |
|  | F Female piston rod thread | - |

Characteristics

| Variants from the modular product system | | |
|---|---------------------------------|---|
| Symbol | Characteristics | Description |
|  | R3 High corrosion protection | All external cylinder surfaces comply with corrosion resistance class 3 to Festo standard 940070. The piston rod is made from corrosion- and acid-resistant steel |
|  | T1 Heat-resistant seals | Temperature range 0 ... +120°C |
|  | T3 Low temperature | Temperature range -40 ... +80°C |
|  | T4 Heat-resistant seals | Temperature range 0 ... +150°C |
|  | A1 Scraper variant | Increased chemical resistance: For longer service life, e.g. when using cooling lubricants. |
|  | A2 Wiper variant | Hard wiper: The cylinder is equipped with a hard-chrome plated piston rod and a hard scraper, which protects against dry, dusty and viscous media |
|  | A3 Wiper variant | Unlubricated operation: Cleaning processes degrease the piston rod. A special piston rod seal designed for unlubricated operation permits a longer service life compared to the standard seal |
|  | A6 Scraper variant | Metal wiper: The cylinder is fitted with a hard-chrome plated piston rod and metal scraper, which scrapes off hard particles (e.g. welding spatter) sticking to the piston rod. Application: Use in welding equipment |
|  | ...E Extended piston rod | - |
|  | ...L Extended piston rod thread | - |

Product range overview

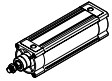
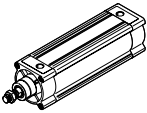
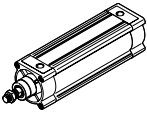
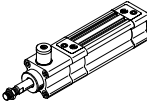
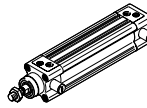
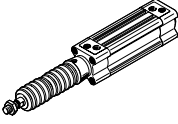
| Function | Version | Type | Piston diameter | Stroke | Through piston rod | Female piston rod thread | Sensor slot on 3 sides | Cushioning | PPS | PPV | |
|---|---|-------------------------|------------------------------|-------------|--------------------|--------------------------|------------------------|------------|-----|-----|---|
| | | | [mm] | [mm] | | | | | | | |
| Double-acting | DSBC... | | | | | | | | | | |
| |  | DSBC... | 32, 40, 50, 63, 80, 100, 125 | 1 ... 2800 | | ■ | ■ | ■ | ■ | ■ | ■ |
| | DSBC...-Q – with protection against rotation | | | | | | | | | | |
| |  | DSBC...-Q | 32, 40, 50, 63, 80, 100 | 1 ... 1500 | | ■ | ■ | ■ | ■ | ■ | ■ |
| | DSBC...-L/-U/-L1 – with special running characteristics | | | | | | | | | | |
| |  | DSBC...-L | 32, 40, 50, 63, 80, 100 | 1 ... 2800 | | - | ■ | ■ | ■ | ■ | ■ |
| | | DSBC...-U | 32, 40, 50, 63, 80, 100, 125 | 1 ... 2800 | | - | ■ | ■ | ■ | ■ | ■ |
| | | DSBC...-L1 | 32, 40, 50, 63, 80, 100, 125 | 10 ... 1000 | | - | ■ | ■ | ■ | ■ | - |
| | DSBC...-C – with clamping unit, standard hole pattern | | | | | | | | | | |
| |  | DSBC...-C | 32, 40, 50, 63, 80, 100, 125 | 10 ... 2000 | | ■ | ■ | ■ | ■ | ■ | ■ |
| DSBC...-E1/-E2/-E3 – with end-position locking, standard hole pattern | | | | | | | | | | | |
|  | DSBC...-E1/-E2/-E3 | 32, 40, 50, 63, 80, 100 | 10 ... 2000 | | - | ■ | ■ | ■ | - | ■ | |
| DSBC...-P2 – with bellows, standard hole pattern | | | | | | | | | | | |
|  | DSBC...-P2 | 32, 40, 50, 63, 80, 100 | 10 ... 500 | | ■ | ■ | ■ | ■ | ■ | ■ | |

Product range overview

| Type | Position sensing | High corrosion protection | Temperature range 0 ... +120°C | Temperature range -40 ... +80°C | Temperature range 0 ... +150°C | Scrapper variant increased chemical resistance | Scrapper variant hard scrapper | Scrapper variant for unlubricated operation | Scrapper variant metal scrapper | EU certification | Piston rod extension | Extended piston rod thread |
|--|------------------|---------------------------|-----------------------------------|------------------------------------|-----------------------------------|--|-----------------------------------|---|------------------------------------|------------------|----------------------|-------------------------------|
| | A | R3 | T1 | T3 | T4 | A1 | A2 | A3 | A6 | EX4 | ...E | ...L |
| DSBC... | | | | | | | | | | | | |
| DSBC... | ■ | ■ | ■ | ■ | ■ | ■ | ■ | ■ | ■ | ■ | ■ | ■ |
| DSBC...-Q – with protection against rotation | | | | | | | | | | | | |
| DSBC...-Q | ■ | ■ | ■ | - | - | - | - | - | - | ■ | ■ | ■ |
| DSBC...-L/-U/-L1 – with special running characteristics | | | | | | | | | | | | |
| DSBC...-L | ■ | - | - | - | - | - | - | - | - | - | ■ | ■ |
| DSBC...-U | ■ | - | - | - | - | - | - | - | - | - | ■ | ■ |
| DSBC...-L1 | ■ | - | - | - | - | - | - | - | - | - | ■ | ■ |
| DSBC...-C – with clamping unit, standard hole pattern | | | | | | | | | | | | |
| DSBC...-C | ■ | - | - | - | - | - | - | - | - | - | ■ | ■ |
| DSBC...-E1/-E2/-E3 – with end-position locking, standard hole pattern | | | | | | | | | | | | |
| DSBC...-E1/ E2/-E3 | ■ | - | - | - | - | - | - | - | - | - | ■ | ■ |
| DSBC...-P2 – with bellows, standard hole pattern | | | | | | | | | | | | |
| DSBC...-P2 | ■ | ■ | - | - | - | - | - | - | - | - | ■ | ■ |

Peripherals overview

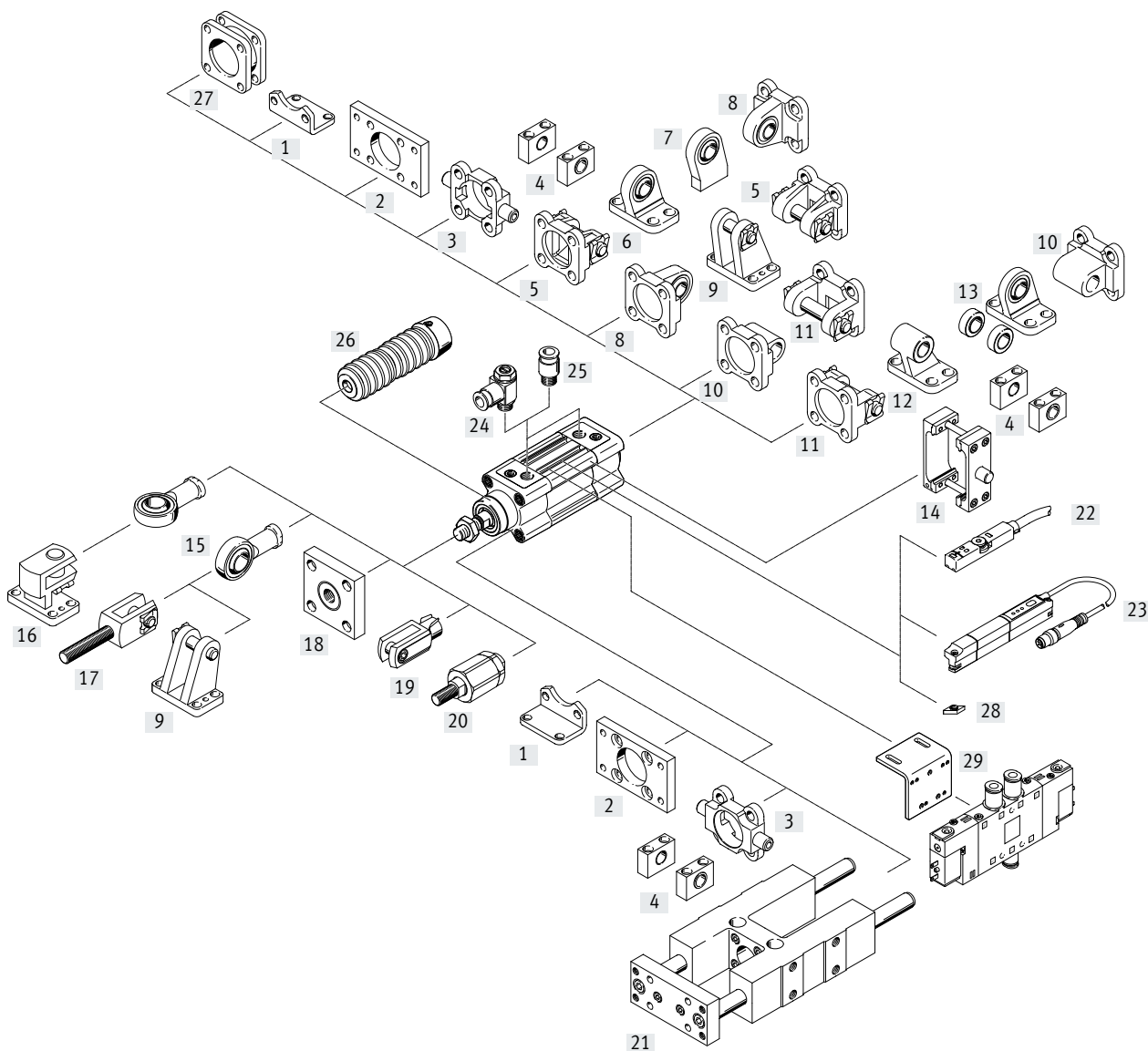

Mounting components and accessories

| | Description | DSBC....- | | | | | → Page/ Internet |
|-------------------------------------|---|-----------|------------|---|-----------------|---|---------------------|
| | | | L/U/ L1 | C | E1/E2/ E3 | T | |
| [1] Foot mounting HNC/CRHNC | For bearing or end caps | ■ | ■ | ■ | ■ | ■ | 40 |
| [2] Flange mounting FNC/CRFNG | <ul style="list-style-type: none"> For bearing or end caps Cannot be used on the bearing cap in combination with the bellows kit DADB | ■ | ■ | ■ | ■ | ■ | 41 |
| [3] Trunnion flange ZNCF/CRZNG | <ul style="list-style-type: none"> For bearing or end caps Cannot be used on the bearing cap in combination with the bellows kit DADB | ■ | ■ | ■ | ■ ¹⁾ | ■ | 42 |
| [4] Trunnion support LNZG/CRLNZG | – | ■ | ■ | ■ | ■ ¹⁾ | ■ | 43 |
| [5] Swivel flange SNC | For end caps | ■ | ■ | ■ | ■ | – | 44 |

1) Cannot be mounted in combination with E1.

Can only be mounted on the end cap in combination with E2.

Can only be mounted on the bearing cap in combination with E3.

Peripherals overview

| | Description | DSBC-...- | | | | | → Page/ Internet | |
|------|--|---|------------|---|--------------|---|---------------------|----|
| | | | L/U/ L1 | C | E1/E2/ E3 | T | | |
| [6] | Clevis foot LSNG | With spherical bearing | ■ | ■ | ■ | ■ | - | 49 |
| [7] | Clevis foot LSNSG | Weld-on, with spherical bearing | ■ | ■ | ■ | ■ | - | 49 |
| [8] | Swivel flange SNCS/CRSNCS/SNCS-...-R3 | With spherical bearing for end caps | ■ | ■ | ■ | ■ | - | 46 |
| [9] | Clevis foot LBG/LBG-...-R3 | - | ■ | ■ | ■ | ■ | - | 49 |
| [10] | Swivel flange SNCL | For end caps | ■ | ■ | ■ | ■ | - | 47 |
| [11] | Swivel flange SNCB/SNCB-...-R3 | For end caps | ■ | ■ | ■ | ■ | - | 45 |
| [12] | Clevis foot LNG/CRLNG | - | ■ | ■ | ■ | ■ | - | 49 |
| [13] | Clevis foot LSN | With spherical bearing | ■ | ■ | ■ | ■ | - | 49 |
| [14] | Trunnion flange kit DAMT | For mounting anywhere along the cylinder profile barrel | ■ | ■ | ■ | ■ | ■ | 48 |
| [15] | Rod eye SGS/CRSGS | With spherical bearing | ■ | ■ | ■ | ■ | ■ | 50 |
| [16] | Right-angle clevis foot LQG | - | ■ | ■ | ■ | ■ | ■ | 49 |
| [17] | Rod clevis SGA | With male thread | ■ | ■ | ■ | ■ | ■ | 50 |
| [18] | Coupling piece KSG | For compensating radial deviations | ■ | ■ | ■ | ■ | ■ | 50 |
| | Coupling piece KSZ | For cylinders with a non-rotating piston rod to compensate for radial deviations | ■ | ■ | ■ | ■ | ■ | 50 |
| [19] | Rod clevis SG/CRSG | Permits a swivelling movement of the cylinder in one plane | ■ | ■ | ■ | ■ | ■ | 50 |
| [20] | Self-aligning rod coupler FK, CRFK | For compensating radial and angular deviations | ■ | ■ | ■ | ■ | ■ | 50 |
| [21] | Guide unit FENG | For protecting standards-based cylinders against rotation at high torque loads | ■ | ■ | ■ | - | ■ | 59 |
| [22] | Proximity switch SME/SMT-8M | Can be integrated in the cylinder profile barrel | ■ | ■ | ■ | ■ | ■ | 60 |
| [23] | Position transmitter SMAT, SDAT | <ul style="list-style-type: none"> Continuously senses the position of the piston Has an analogue output | ■ | ■ | ■ | ■ | ■ | 61 |
| [24] | One-way flow control valve GRLA | For speed regulation | ■ | ■ | ■ | ■ | ■ | 62 |
| [25] | Push-in fitting QS | For connecting compressed air tubing with standard O.D. | ■ | ■ | ■ | ■ | ■ | qs |
| [26] | Bellows kit DADB | <ul style="list-style-type: none"> Protects the cylinder (piston rod, seal and bearings) against a wide range of media and thus prevents premature wear Can only be used in combination with an extended piston rod (E) | ■ | - | - | - | ■ | 51 |
| [27] | Multi-position kit DPNC | For connecting two cylinders with identical piston diameters to form a multi-position cylinder | ■ | - | ■ | ■ | ■ | 55 |
| [28] | Slot nut ABAN | Inserted in slot from above | ■ | ■ | ■ | ■ | ■ | 62 |
| [29] | Mounting kit DAVM | For mounting the valve | ■ | ■ | ■ | ■ | ■ | 56 |
| - | Slot cover ABP-5-S | For protecting the sensor cable and the sensor slots from contamination | ■ | ■ | ■ | ■ | ■ | 62 |

Type codes

| | | |
|------|---|--|
| 001 | Series | |
| DSBC | Standards-based cylinder, double-acting, based on ISO 15552 | |

| | | |
|-----|----------------------------------|--|
| 002 | Protection against rotation | |
| | None | |
| Q | With protection against rotation | |

| | | |
|-----|--|--|
| 003 | Running characteristics | |
| | Standard | |
| L | Low friction | |
| U | Uniform, slow movement | |
| L1 | Low friction for balancer applications | |

| | | |
|-----|-----------------|--|
| 004 | Piston diameter | |
| 32 | 32 | |
| 40 | 40 | |
| 50 | 50 | |
| 63 | 63 | |
| 80 | 80 | |
| 100 | 100 | |
| 125 | 125 | |

| | | |
|-----|------------|--|
| 005 | Stroke | |
| 20 | 20 | |
| 25 | 25 | |
| 30 | 30 | |
| 40 | 40 | |
| 50 | 50 | |
| 60 | 60 | |
| 70 | 70 | |
| 80 | 80 | |
| 100 | 100 | |
| 125 | 125 | |
| 150 | 150 | |
| 160 | 160 | |
| 200 | 200 | |
| 250 | 250 | |
| 300 | 300 | |
| 320 | 320 | |
| 400 | 400 | |
| 500 | 500 | |
| ... | 1 ... 2800 | |

| | | |
|-----|---------------|--|
| 006 | Clamping unit | |
| | None | |
| C | Attached | |

| | | |
|-----|---------------------------|--|
| 007 | End-position locking | |
| | None | |
| E1 | Both sides | |
| E2 | With advanced piston rod | |
| E3 | With retracted piston rod | |

| | | |
|-----|--------------------|--|
| 008 | Piston rod type | |
| | At one end | |
| T | Through piston rod | |

| | | |
|-----|------------------------|--|
| 009 | Piston rod thread type | |
| | Male thread | |
| F | Female thread | |

| | | |
|-----|--------------------------------------|--|
| 010 | Profile type | |
| | Sensor slot on one profile side only | |
| D3 | Sensor slots on 3 profile sides | |

| | | |
|-----|---|--|
| 011 | Cushioning | |
| P | Elastic cushioning rings/plates on both sides | |
| PPS | Pneumatic cushioning, self-adjusting at both ends | |
| PPV | Pneumatic cushioning, adjustable at both ends | |

| | | |
|-----|----------------------|--|
| 012 | Position sensing | |
| A | For proximity sensor | |

| | | |
|-----|---------------------------|--|
| 013 | Corrosion protection | |
| | Standard | |
| R3 | High corrosion protection | |

| | | |
|-----|---------------------------------|--|
| 014 | Temperature range | |
| | Standard | |
| T1 | Heat-resistant seals max. 120°C | |
| T3 | -40 ... +80°C | |
| T4 | 0 ... +150°C | |

| | | |
|-----|------------------------------|--|
| 015 | Protection against particles | |
| | Standard | |
| P2 | Bellows on bearing cap | |

| | | |
|-----|-------------------------------|--|
| 016 | Scraper variant | |
| | None | |
| A1 | Increased chemical resistance | |
| A2 | Hard scraper | |
| A3 | For unlubricated operation | |
| A6 | Metal scraper | |

| | | |
|-----|---|--|
| 017 | Special material properties | |
| | None | |
| F1A | Recommended for production facilities for the manufacture of lithium-ion batteries (Cu<=1%, Zn<=1%, Ni<=1%) | |

| | | |
|-----|------------------|--|
| 018 | EU certification | |
| | None | |
| EX4 | II 2GD | |

| | | |
|------|----------------------|--|
| 019 | Piston rod extension | |
| | None | |
| ...E | 1 ... 500 mm | |

| | | |
|------|-----------------------------|--|
| 020 | Piston rod thread extension | |
| | None | |
| ...L | 0 ... 70 mm | |

Data sheet

Function

Elastic cushioning

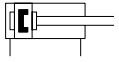

PPV cushioning

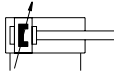

PPS cushioning

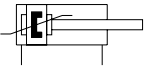

⌀ Diameter
32 ... 125 mm

— Stroke length
1 ... 2800 mm



www.festo.com

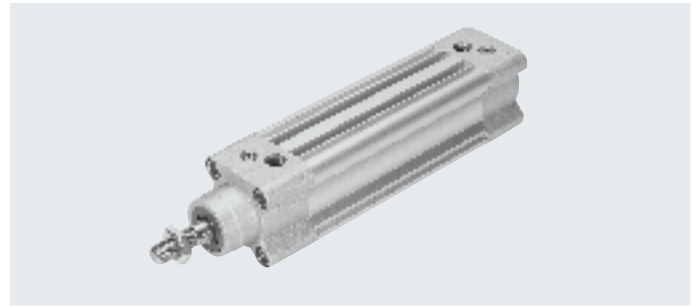

General technical data

| Piston diameter | 32 | 40 | 50 | 63 | 80 | 100 | 125 |
|-------------------------|---|----------|---------|---------|---------|---------|-------|
| Design | Piston/piston rod/profile barrel | | | | | | |
| Mode of operation | Double-acting | | | | | | |
| Pneumatic connection | G1/8 | G1/4 | G1/4 | G3/8 | G3/8 | G1/2 | G1/2 |
| Piston rod thread | M10x1.25 | M12x1.25 | M16x1.5 | M16x1.5 | M20x1.5 | M20x1.5 | M27x2 |
| Stroke | | | | | | | |
| DSBC... [mm] | 1 ... 2800 | | | | | | |
| DSBC...-Q [mm] | 1 ... 1500 | | | | | | - |
| DSBC...-L1 [mm] | 10 ... 1000 | | | | | | |
| DSBC...-C [mm] | 10 ... 2000 | | | | | | |
| DSBC...-E1/-E2/-E3 [mm] | 10 ... 2000 | | | | | | - |
| DSBC...-P2 [mm] | 10 ... 500 | | | | | | - |
| DSBC...-E [mm] | 1 ... 2000 | | | | | | |
| DSBC...-L [mm] | 1 ... 2000 | | | | | | |
| Cushioning | | | | | | | |
| DSBC...-P | Elastic cushioning rings/plates at both ends | | | | | | |
| DSBC...-PPV | Pneumatic cushioning, adjustable at both ends | | | | | | |
| DSBC...-PPS | Pneumatic cushioning, self-adjusting at both ends | | | | | | |
| Cushioning length | | | | | | | |
| DSBC...-PPV [mm] | 17 | 19 | 22 | 22 | 31 | 31 | 45 |
| DSBC...-E1/-E2/-E3 [mm] | 17 | 19 | 15 | 15 | 15 | 15 | - |
| Position sensing | Via proximity switch | | | | | | |
| Type of mounting | With female thread/accessories | | | | | | |
| Mounting position | Any | | | | | | |

Data sheet

| Operating and environmental conditions | | | | | | | | | |
|--|-------|--|---------------|---------------|--------------|---------------|--------------|---------------|--|
| Piston diameter | | 32 | 40 | 50 | 63 | 80 | 100 | 125 | |
| Operating medium | | Compressed air to ISO 8573-1:2010 [7:4:4] | | | | | | | |
| Note on the operating/pilot medium | | Lubricated operation possible (in which case lubricated operation will always be required) | | | | | | | |
| Operating pressure | | | | | | | | | |
| DSBC... | [MPa] | 0.06 ... 1.2 | | 0.04 ... 1.2 | | | | 0.02 ... 1.0 | |
| | [bar] | 0.6 ... 12 | | 0.4 ... 12 | | | | 0.2 ... 10 | |
| DSBC...-L ¹⁾ | [MPa] | 0.03 ... 1.2 | 0.025 ... 1.2 | | 0.02 ... 1.2 | 0.015 ... 1.2 | - | | |
| | [bar] | 0.3 ... 12 | 0.25 ... 12 | | 0.2 ... 12 | 0.15 ... 12 | - | | |
| DSBC...-U ¹⁾ | [MPa] | 0.01 ... 1.2 | | 0.005 ... 1.2 | | | | 0.005 ... 1.0 | |
| | [bar] | 0.1 ... 12 | | 0.05 ... 12 | | | | 0.05 ... 10 | |
| DSBC...-L ¹⁾ | [MPa] | 0.03 ... 1.2 | 0.025 ... 1.2 | | 0.02 ... 1.2 | 0.015 ... 1.2 | 0.01 ... 1.0 | | |
| | [bar] | 0.3 ... 12 | 0.25 ... 12 | | 0.2 ... 12 | 0.15 ... 12 | 0.1 ... 10 | | |
| DSBC...-C ²⁾ | [MPa] | 0.15 ... 1.0 | | | | | | | |
| | [bar] | 1.5 ... 10 | | | | | | | |
| DSBC...-E1/-E2/-E3 | [MPa] | 0.25 ... 1.2 | | 0.15 ... 1.2 | | | | - | |
| | [bar] | 2.5 ... 12 | | 1.5 ... 12 | | | | - | |
| DSBC...-T3/-A2 | [MPa] | 0.1 ... 1.2 | | | | | | 0.1 ... 1.0 | |
| | [bar] | 1 ... 12 | | | | | | 1 ... 10 | |
| DSBC...-A3 | [MPa] | 0.15 ... 1.2 | | 0.1 ... 1.2 | 0.06 ... 1.2 | | | 0.06 ... 1.0 | |
| | [bar] | 1.5 ... 12 | | 1 ... 12 | 0.6 ... 12 | | | 0.6 ... 10 | |
| DSBC...-A6 | [MPa] | 0.2 ... 1.2 | 0.15 ... 1.2 | | | | 0.15 ... 1.0 | | |
| | [bar] | 2 ... 12 | 1.5 ... 12 | | | | 1.5 ... 10 | | |
| Ambient temperature ³⁾ | | | | | | | | | |
| DSBC... | [°C] | -20 ... +80 | | | | | | | |
| DSBC...-L/-U | [°C] | +5 ... +80 | | | | | | | |
| DSBC...-L1 | [°C] | 0 ... +60 | | | | | | | |
| DSBC...-A1 | [°C] | 0 ... +80 | | | | | | | |
| DSBC...-A6 | [°C] | -20 ... +80 | | | | | | | |
| DSBC...-T1-A6 | [°C] | 0 ... +120 | | | | | | | |
| DSBC...-T3-A6 | [°C] | -40 ... +80 | | | | | | | |
| DSBC...-T4-A6 | [°C] | 0 ... +150 | | | | | | | |
| DSBC...-C | [°C] | -10 ... +80 | | | | | | | |
| DSBC...-T1 | [°C] | 0 ... +120 | | | | | | | |
| DSBC...-T3 | [°C] | -40 ... +80 | | | | | | | |
| DSBC...-T4 | [°C] | 0 ... +150 | | | | | | | |
| DSBC...-P2 | [°C] | -10 ... +80 | | | | | | - | |
| DSBC...-EX4 | [°C] | -20 ... +60 | | | | | | | |
| Corrosion resistance CRC | | | | | | | | | |
| DSBC... | | 2 ⁴⁾ | | | | | | | |
| DSBC...-R3 | | 3 ⁵⁾ | | | | | | | |

1) Values apply only for strokes ≤ 500 mm and after 10 double strokes.

In combination with cushioning PPV/PPS, the specifications only apply outside the cushioning range

2) Note min. release pressure → page 19

3) Note operating range of proximity switches.

4) Corrosion resistance class CRC 2 to Festo standard FN 940070

Moderate corrosion stress. Indoor applications in which condensation can occur. External visible parts with primarily decorative surface requirements which are in direct contact with a normal industrial environment.

5) Corrosion resistance class CRC 3 to Festo standard FN 940070

High corrosion stress. Outdoor exposure under moderate corrosive conditions. Externally visible parts with primarily functional surface requirements which are in direct contact with a normal industrial environment.

Data sheet

| Weight [g] | | | | | | | |
|------------------------------------|-----|------|------|------|------|------|-------|
| Piston diameter | 32 | 40 | 50 | 63 | 80 | 100 | 125 |
| DSBC... | | | | | | | |
| Product weight with 0 mm stroke | 465 | 740 | 1190 | 1740 | 2660 | 3665 | 6611 |
| Additional weight per 10 mm stroke | 27 | 37 | 56 | 62 | 92 | 101 | 151 |
| Moving mass with 0 mm stroke | 110 | 205 | 365 | 430 | 810 | 1000 | 2245 |
| Moving mass per 10 mm stroke | 9 | 16 | 25 | 25 | 39 | 39 | 63 |
| DSBC...-Q | | | | | | | |
| Product weight with 0 mm stroke | 503 | 755 | 1241 | 1821 | 2717 | 3827 | – |
| Additional weight per 10 mm stroke | 25 | 30 | 51 | 57 | 87 | 95 | – |
| Moving mass with 0 mm stroke | 115 | 170 | 332 | 391 | 757 | 890 | – |
| Moving mass per 10 mm stroke | 8 | 11 | 20 | 20 | 31 | 31 | – |
| DSBC...-C | | | | | | | |
| Product weight with 0 mm stroke | 745 | 1175 | 1940 | 2920 | 5075 | 6965 | 12860 |
| Additional weight per 10 mm stroke | 25 | 35 | 56 | 62 | 95 | 103 | 151 |
| Moving mass with 0 mm stroke | 160 | 290 | 540 | 620 | 1200 | 1425 | 3035 |
| Moving mass per 10 mm stroke | 9 | 16 | 25 | 25 | 39 | 39 | 63 |
| DSBC...-E1/-E2/-E3 | | | | | | | |
| Product weight with 0 mm stroke | | | | | | | |
| DSBC...-E1 | 505 | 780 | 1312 | 1862 | 3018 | 4023 | – |
| DSBC...-E2 | 485 | 760 | 1251 | 1801 | 2839 | 3844 | – |
| DSBC...-E3 | 485 | 760 | 1251 | 1801 | 2839 | 3844 | – |
| Additional weight per 10 mm stroke | 27 | 37 | 56 | 62 | 92 | 101 | – |
| Moving mass with 0 mm stroke | 110 | 205 | 365 | 430 | 810 | 1000 | – |
| Moving mass per 10 mm stroke | 9 | 16 | 25 | 25 | 39 | 39 | – |
| DSBC...-T | | | | | | | |
| Product weight with 0 mm stroke | 581 | 924 | 1523 | 2103 | 3243 | 4353 | 7450 |
| Additional weight per 10 mm stroke | 34 | 50 | 81 | 86 | 133 | 141 | 214 |
| Moving mass with 0 mm stroke | 181 | 339 | 613 | 684 | 1292 | 1516 | 3084 |
| Moving mass per 10 mm stroke | 18 | 32 | 50 | 50 | 78 | 78 | 126 |

Data sheet

| ATEX ¹⁾ | |
|--|---|
| ATEX category for gas | II 2G |
| Type of ignition protection for gas | Ex h IIC T4 Gb |
| ATEX category for dust | II 2D |
| Type of ignition protection for dust | Ex h IIIC T120°C Db |
| Explosion-proof ambient temperature | -20°C ≤ Ta ≤ +60°C |
| CE marking (see declaration of conformity) | To EU Explosion Protection Directive (ATEX) |

1) Note the ATEX certification of the accessories.

| Forces [N] and impact energy [J] | | | | | | | |
|---|-------------------|------|------|------|------|------|------|
| Piston diameter | 32 | 40 | 50 | 63 | 80 | 100 | 125 |
| Theoretical force at 6 bar, advancing | 483 | 754 | 1178 | 1870 | 3016 | 4712 | 7363 |
| Theoretical force at 6 bar, retracting | 415 | 633 | 990 | 1682 | 2721 | 4418 | 6881 |
| Max. impact energy in the end positions | | | | | | | |
| DSBC... | 0.4 ¹⁾ | 0.7 | 1.0 | 1.3 | 1.8 | 2.5 | 3.3 |
| DSBC...-L/-U/-T1/-T3/-T4 | 0.2 ¹⁾ | 0.35 | 0.5 | 0.65 | 0.9 | 1.25 | 1.65 |
| DSBC...-L1 | 0.1 | 0.2 | 0.3 | 0.4 | 0.9 | 1.25 | 1.65 |

1) The max. impact energy in combination with the trunnion flange kit DAMT is 0.1 J.

Permissible impact velocity:
$$V = \sqrt{\frac{2 \times E}{m_1 + m_2}}$$

Maximum permissible mass:
$$m_2 = \frac{2 \times E}{v^2} - m_1$$

V Permissible impact velocity
 E Max. impact energy
 m1 Moving mass (drive)
 m2 Moving payload

Max. transverse load F_q as a function of stroke length l

Horizontal installation

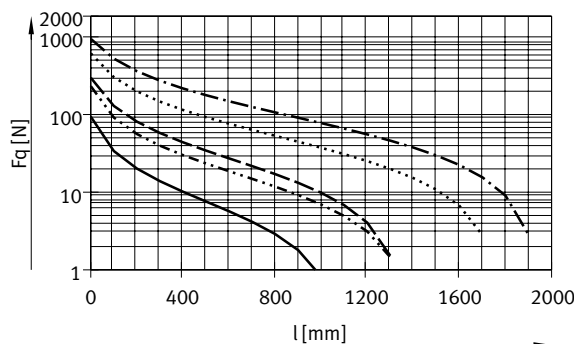

Vertical installation

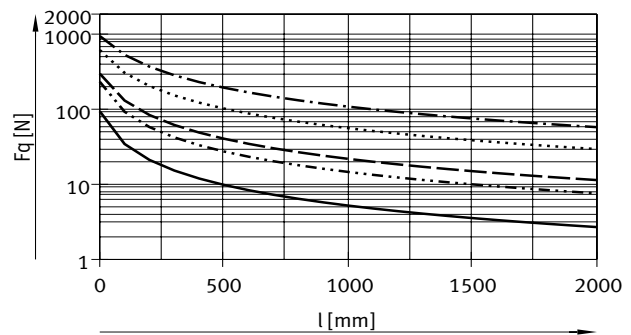

- ∅ 32
- · - · ∅ 40
- - - ∅ 50/63
- · · ∅ 80/100
- · - · ∅ 125

Note

No transverse forces are permitted in combination with feature DSBC...-L1.

| Permissible torsional backlash with variant Q – With protection against rotation | | | | | | | |
|--|-----|-------|------|-------|-------|-------|-------|
| Piston diameter | | 32 | 40 | 50 | 63 | 80 | 100 |
| Torsional backlash | [°] | ±0.65 | ±0.6 | ±0.45 | ±0.45 | ±0.45 | ±0.45 |

Data sheet

Max. transverse force F_q as a function of stroke length l and lever arm s

Q – With protection against rotation

∅ 32

Max. torque = 800 Nmm/max. stroke = 300 mm

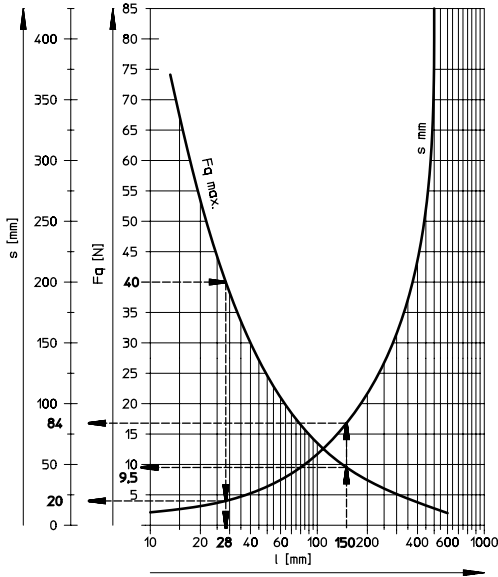

∅ 40

Max. torque = 1100 Nmm/max. stroke = 400 mm

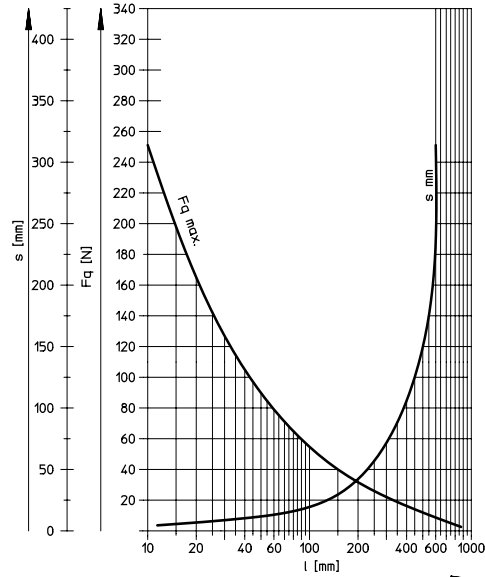

∅ 50/63

Max. torque = 1500 Nmm/max. stroke = 500 mm

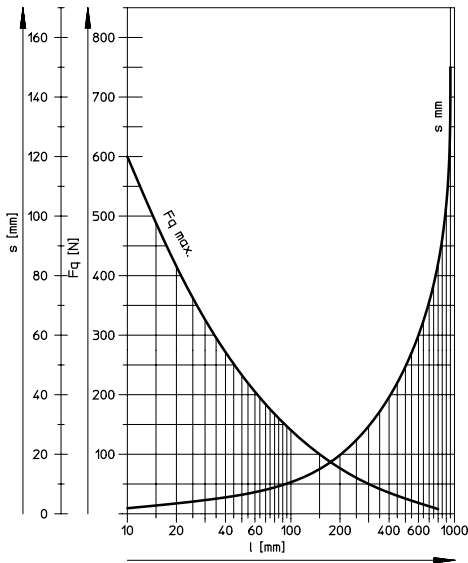

∅ 80/100

Max. torque = 3000 Nmm/max. stroke = 600 mm

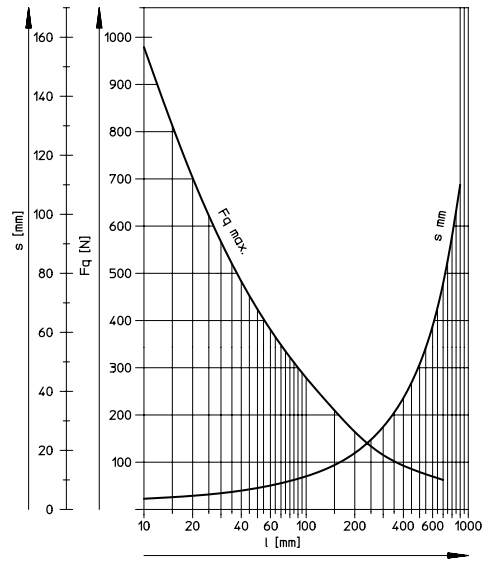

Examples for piston diameter 32 mm

Example 1:

Stroke length l = 150 mm

Result: Permissible

Transverse force F_q = 9.5 N

Lever arm s = 84 mm

Example 2:

Transverse force F_q = 40 N

Result: Permissible

Stroke length l = 28 mm

Lever arm s = 20 mm

Example 3:

Stroke length l = 150 mm

Lever arm s = 100 mm

$$F_q = \frac{M}{s} = \frac{800 \text{ Nmm}}{100 \text{ mm}}$$

M = Max. torque

s = Lever arm

Result: Permissible

$$F_q = 8 \text{ N} < F_{q_{max}} = 9.5 \text{ N}$$

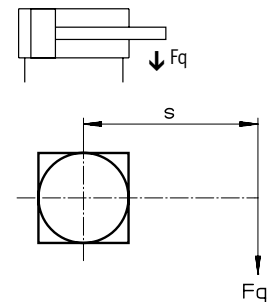

Data sheet

Materials

Sectional view – Basic design

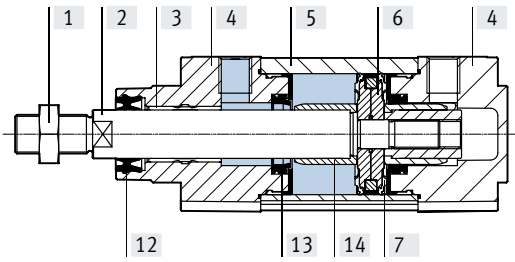

With clamping unit

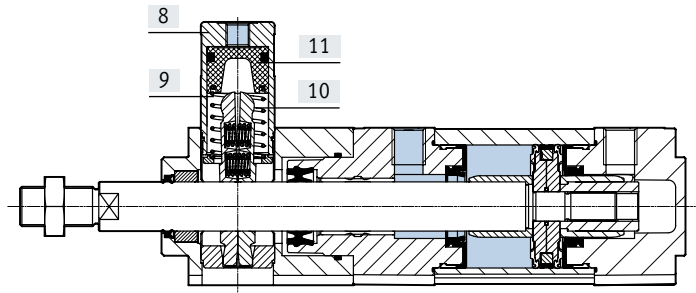

With end-position locking

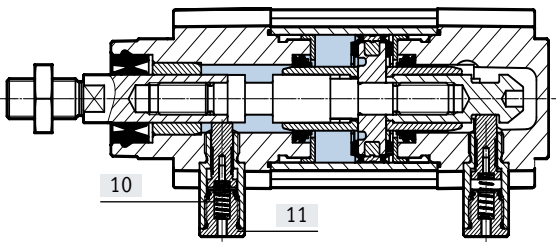

Data sheet

| Standards-based cylinder | |
|---|--|
| [1] Nut | Galvanised steel |
| [2] Piston rod | |
| DSBC... | High-alloy steel |
| DSBC...-R3 | High-alloy stainless steel |
| DSBC...-A2/-A6 | Hard-chrome plated tempered steel |
| [3] Bearing | |
| DSBC... | POM |
| DSBC...-E1/-E2/-E3/-SL/-EX4/-A2/-Q | Bronze |
| DSBC...-L/-U/-T1/-T4 | Metal polymer compound |
| [4] Cover | Coated die-cast aluminium |
| [5] Profile barrel | Anodised wrought aluminium alloy |
| [6] Piston | Anodised wrought aluminium alloy |
| [7] Piston seal | |
| DSBC... | TPE-U(PU) |
| DSBC...-L/-U/-T1/-T4 | FPM |
| DSBC...-T3 | TPE-U(PU) |
| DSBC...-L1 | HNBR |
| [8] Housing, clamping unit | Anodised wrought aluminium alloy |
| [9] Clamping jaws, clamping unit | Brass |
| [10] Spring | |
| DSBC...-C | Spring steel |
| DSBC...-E1/E2/E3 | High-alloy stainless steel |
| [11] Piston, clamping unit/end-position locking | |
| DSBC...-C | POM |
| DSBC...-E1/E2/E3 | Hardened steel |
| [12] Piston rod wiper seal | |
| DSBC... | PUR |
| DSBC...-L/-U | FPM |
| DSBC...-L1 | HNBR |
| DSBC...-T1/-T4/-A1 | FPM |
| DSBC...-T3 | PUR (suitable for low temperatures) |
| DSBC...-A3 | UHMW-PE |
| [13] Buffer seal | |
| DSBC... | PUR |
| DSBC...-U | FPM |
| DSBC...-T1/-T4 | FPM |
| DSBC...-T3 | PUR (suitable for low temperatures) |
| [14] Buffer sleeve | |
| DSBC... | POM |
| DSBC...-L/-U | Aluminium |
| DSBC...-T1/-T3/-T4 | Aluminium |
| - Piston rod scraper | |
| DSBC...-A6 | CuZn |
| DSBC...-T3/-A2 | PTFE reinforced |
| - Housing, end-position locking | Anodised wrought aluminium alloy |
| - Flange screw | Galvanised steel |
| - Note on materials | |
| DSBC... | RoHS-compliant |
| DSBC...-L/U/-T3/-T4/-A3 | Contains paint-wetting impairment substances |
| DSBC...-F1A | Metals with copper, zinc or nickel as the main constituent are excluded from use. Exceptions are nickel in steels, chemically nickel-plated surfaces, printed circuit boards, cables, electrical plug connectors and coils. |

Data sheet

Technical data DSBC-...-E1/-E2/-E3 – With end-position locking

- In order to ensure that the lock is completely released prior to starting the drive movement, end-position locking should only be used in conjunction with double-acting cylinders with exhaust-air flow control.
- The end-position locking may only be released if the forces at the piston have reached equilibrium. Otherwise, a sudden movement of the piston rod could cause accidents. Blocking off the air supply at both ends (e.g. with a 5/3-way valve) does not provide any safety.
- The piston rod can be locked in any stroke position once the drive is brought mechanically into its end position.
- An excessive end-position cushioning setting (more than 50% closed) can result in the locking bolt not engaging reliably, resulting in premature wear.
- The exhaust hole must not be closed.

| Piston diameter | | 32 | 40 | 50 | 63 | 80 | 100 |
|--|-------|--|-----|--------|------|------|------|
| Clamping type | | Positive interlocking with stop cylinder | | | | | |
| | | Release through compressed air | | | | | |
| Static holding force | [N] | 500 | 500 | 2000 | 2000 | 5000 | 5000 |
| Max. axial backlash with end position locked | [mm] | 1.3 | 1.3 | 1.3 | 1.5 | 1.5 | 1.5 |
| Min. unlocking pressure | [MPa] | ≤ 0.25 | | ≤ 0.15 | | | |
| | [bar] | ≤ 2.5 | | ≤ 1.5 | | | |
| Max. locking pressure | [MPa] | ≥ 0.05 | | | | | |
| | [bar] | ≥ 0.5 | | | | | |

Sizing example

When sizing pneumatic cylinders it is recommended as a basic principle that only 50% of the indicated theoretical forces (see above) be used.

Given:

Mounting position = vertical

Workpiece load = 44 kg

$$F = m \times g = 44 \text{ kg} \times 9.81 \text{ m/s}^2 \\ = 431.6 \text{ N}$$

To be calculated:

Suitable piston diameter

Example with 32 mm piston diameter:

Theoretical force at 6 bar, advancing = 483 N

50% of the theoretical force = 241.5 N

Static holding force with 32 mm piston diameter = 500 N

The static holding force of end-position locking is within the permissible range (max. 500 N) for a workpiece load of 44 kg (431.6 N); however the cylinder would be at 89% capacity.

Result:

A cylinder with a piston diameter of 40 mm is therefore recommended for this application.

Data sheet

Technical data DSBC-...C – With clamping unit

- The specified holding force refers to a static load. If this value is exceeded, the piston rod may slip. Dynamic forces occurring during operation must not exceed the static holding force. The clamping unit is not backlash-free in the clamped condition if varying loads are applied to the piston rod.
- The clamping unit may only be released if the forces at the piston have reached equilibrium. Otherwise, a sudden movement of the piston rod could cause accidents. Blocking off the air supply at both ends (e.g. with a 5/3-way valve) does not provide any safety.

| Piston diameter | | 32 | 40 | 50 | 63 | 80 | 100 | 125 |
|--|-------|--------------------------------|------|------|------|------|------|------|
| Type of clamping with active direction | | At both ends | | | | | | |
| | | Clamping through spring force | | | | | | |
| | | Release through compressed air | | | | | | |
| Static holding force | [N] | 600 | 1000 | 1400 | 2000 | 5000 | 5000 | 7500 |
| Max. axial play under load | [mm] | 0.5 | 0.5 | 0.8 | 0.8 | 0.8 | 0.8 | 1.8 |
| Min. release pressure | [MPa] | 0.3 | | | | | | |
| | [bar] | 3 | | | | | | |

Data sheet

Dimensions

Download CAD data → www.festo.com

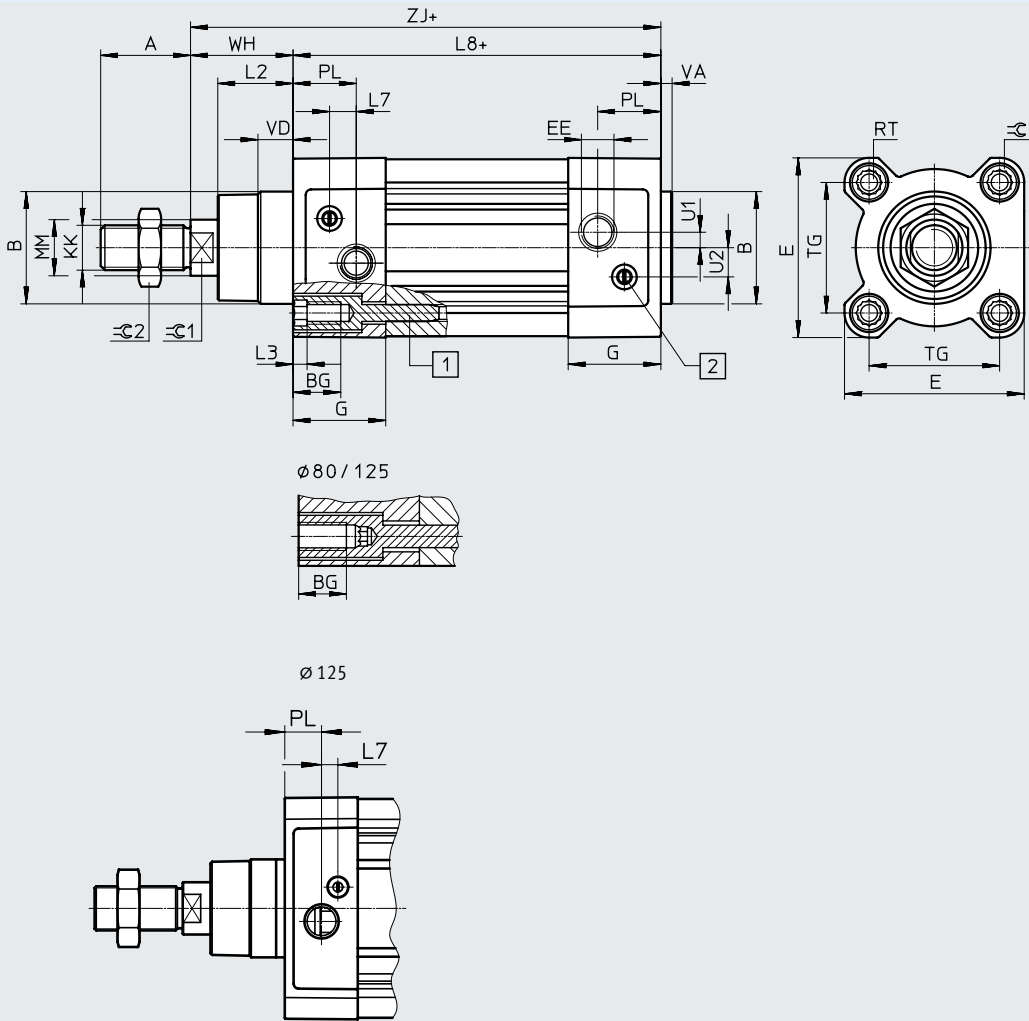

Variant

T – Through piston rod

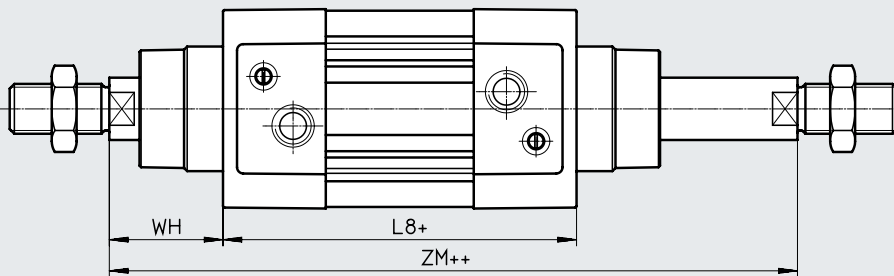

+ = plus stroke length
 ++ = plus 2x stroke length

Data sheet

| ∅ [mm] | A -0.5 | B ∅ d11 | BG min. | E +0.5 | EE | G -0.2 | U2 ±0.1 | U1 ±0.1 | KK |
|-----------|-----------|---------------|------------|-----------|------|-----------|------------|------------|----------|
| 32 | 22 | 30 | 16 | 45 | G1/8 | 28 | 5.7 | 5.25 | M10x1.25 |
| 40 | 24 | 35 | 16 | 54 | G1/4 | 33 | 8 | 4 | M12x1.25 |
| 50 | 32 | 40 | 16 | 64 | G1/4 | 33 | 10.4 | 5.5 | M16x1.5 |
| 63 | 32 | 45 | 16 | 75 | G3/8 | 40.5 | 12.75 | 6.25 | M16x1.5 |
| 80 | 40 | 45 | 17 | 93 | G3/8 | 43 | 12.5 | 8 | M20x1.5 |
| 100 | 40 | 55 | 17 | 110 | G1/2 | 48 | 13.5 | 10 | M20x1.5 |
| 125 | 54 | 60 | 20 | 136 | G1/2 | 44.7 | 13 | 8 | M27x2 |

| ∅ [mm] | L2 | L3 max. | L7 | L8 ±0.4 | MM ∅ | PL ±0.1 | RT | TG ±0.3 |
|-----------|----------------------|------------|-----|------------|---------|------------|-----|------------|
| 32 | 18 _{-0.2} | 5 | 6.5 | 94 | 12 | 19.5 | M6 | 32.5 |
| 40 | 21.3 _{-0.2} | 5 | 7.5 | 105 | 16 | 22.5 | M6 | 38 |
| 50 | 26.8 _{-0.2} | 5 | 9.5 | 106 | 20 | 22.5 | M8 | 46.5 |
| 63 | 27 _{-0.2} | 5 | 9 | 121 | 20 | 27.5 | M8 | 56.5 |
| 80 | 34.2 _{-0.2} | – | 11 | 128 | 25 | 30 | M10 | 72 |
| 100 | 38 _{-0.2} | – | 7.5 | 138 | 25 | 31.5 | M10 | 89 |
| 125 | 45.5 _{-0.3} | – | 10 | 160 | 32 | 22.5 | M12 | 110 |

| ∅ [mm] | VA | VD +0.5 | WH +2.2 | ZJ +1.8 | ZM +1 | ⊖G1 | ⊖G2 | ⊖G3 |
|-----------|-------------------|------------|------------|------------|----------|-----|-----|-----|
| 32 | 4 _{-0.2} | 10 | 25 | 119.1 | 146.1 | 10 | 16 | 6 |
| 40 | 4 _{-0.2} | 10.5 | 28.7 | 133.9 | 164.8 | 13 | 18 | 6 |
| 50 | 4 _{-0.2} | 11.5 | 35.6 | 141.8 | 179.8 | 17 | 24 | 8 |
| 63 | 4 _{-0.2} | 15 | 35.9 | 157.1 | 195.4 | 17 | 24 | 8 |
| 80 | 4 _{-0.2} | 15.7 | 45.4 | 173.6 | 221 | 22 | 30 | 6 |
| 100 | 4 _{-0.2} | 19.2 | 49.3 | 187.5 | 238.8 | 22 | 30 | 6 |
| 125 | 6 _{-0.3} | 20.5 | 64.1 | 225 | 290 | 27 | 41 | 8 |

Data sheet

Dimensions – Variants

Download CAD data → www.festo.com

Q – With protection against rotation

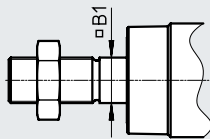

- - **Note**

In combination with variant T, the piston rod is protected against rotation at one end.

F – Female thread

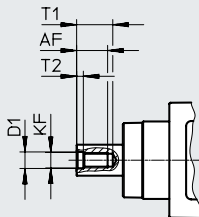

- - **Note**

In combination with variant T, the piston rod has female threads at both ends.

...E – Extended piston rod

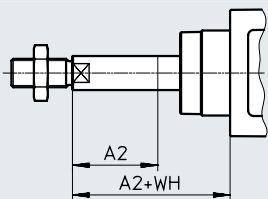

- - **Note**

Piston rod thread is extended at one end in combination with the variant T. Piston rod extension only at the square piston rod in combination with the variants T and Q

...L – Extended piston rod thread

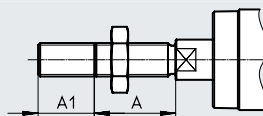

- - **Note**

Piston rod thread is extended at both ends in combination with variant T.

D3 – Sensor slot on 3 sides

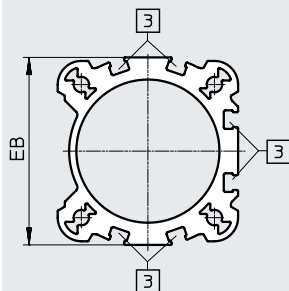

[3] Sensor slot for proximity switch

Data sheet

| ∅ [mm] | A | A1 | | A2 | | AF min. |
|-----------|----|------|------|------|------|------------|
| | | min. | max. | min. | max. | |
| 32 | 22 | 1 | 35 | 1 | 500 | 12 |
| 40 | 24 | 1 | 35 | 1 | 500 | 12 |
| 50 | 32 | 1 | 70 | 1 | 500 | 16 |
| 63 | 32 | 1 | 70 | 1 | 500 | 16 |
| 80 | 40 | 1 | 70 | 1 | 500 | 20 |
| 100 | 40 | 1 | 70 | 1 | 500 | 20 |
| 125 | 54 | 1 | 70 | 1 | 500 | 32 |

| ∅ [mm] | B1 | D1 | EB | KF | T1 | T2 | WH +2.2 |
|-----------|----|------|----------------------------|-----|------|-----|------------|
| | | | | | max. | | |
| 32 | 10 | 6.4 | 47 _{-0.3} | M6 | 16 | 2.6 | 25 |
| 40 | 12 | 8.4 | 54.8 ^{+0.3} | M8 | 16 | 3.3 | 28.7 |
| 50 | 16 | 10.5 | 65.5 ^{+0.3/-0.05} | M10 | 21 | 4.7 | 35.6 |
| 63 | 16 | 10.5 | 76 ₋₁ | M10 | 21 | 4.7 | 35.9 |
| 80 | 20 | 13 | 92 _{-0.5} | M12 | 26.5 | 6.1 | 45.4 |
| 100 | 20 | 13 | 109 _{-0.5} | M12 | 26.5 | 6.1 | 49.3 |
| 125 | – | 17 | 132 ^{+0.8} | M16 | 40 | 8 | 64.1 |

Data sheet

Dimensions – Variants

Download CAD data → www.festo.com

C – Clamping unit

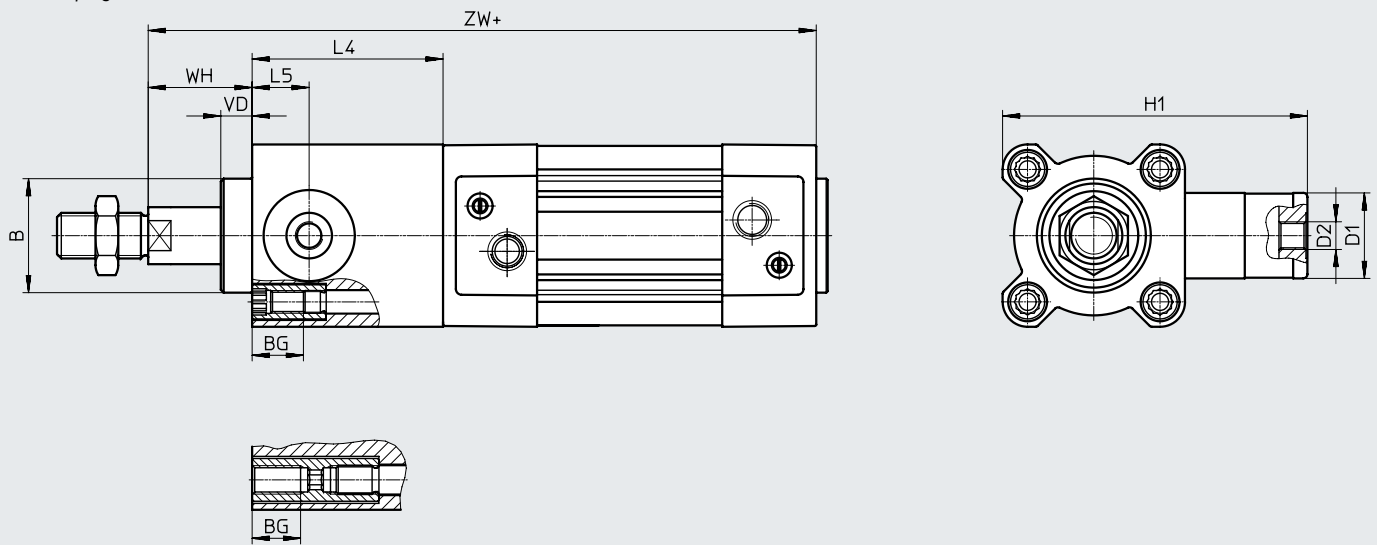

 - **Note**

The clamping unit can only be selected with variant T in combination with variant Q.

The clamping unit is mounted on the round piston rod end in combination with variants T and Q.

+ = plus stroke length

| ∅ [mm] | B ∅ d11 | BG | D1 | D2 | H1 | L4 ±0.2 | L5 | VD | WH | ZW ±1.8 |
|-----------|---------------|----|----|------|-----|------------|------|------|----|------------|
| 32 | 30 | 16 | 20 | M5 | 67 | 45 | 14 | 11.5 | 26 | 164.1 |
| 40 | 35 | 16 | 24 | G1/8 | 88 | 53 | 16 | 11.5 | 30 | 186.9 |
| 50 | 40 | 16 | 30 | G1/8 | 107 | 67 | 20 | 11 | 37 | 208.8 |
| 63 | 45 | 16 | 38 | G1/8 | 123 | 76 | 24 | 11 | 37 | 233.1 |
| 80 | 45 | 17 | 48 | G1/8 | 165 | 95 | 31.5 | 12.5 | 46 | 268.6 |
| 100 | 55 | 17 | 48 | G1/8 | 174 | 98 | 31 | 12 | 51 | 285.7 |
| 125 | 60 | 20 | 65 | G1/8 | 208 | 125 | 42 | 27.5 | 65 | 349.3 |

Data sheet

Dimensions – Variants

Download CAD data → www.festo.com

E1/E2/E3 – End-position locking

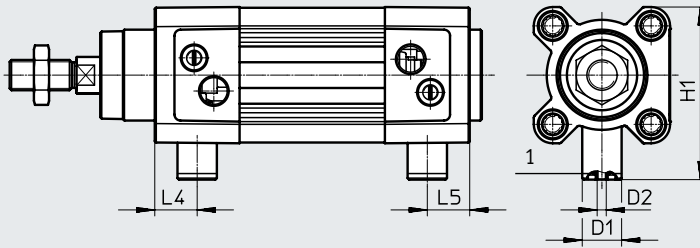

- [1] - **Note**

- [1] The connection is used for the manual interlock and/or ducted exhaust air. It must not be sealed or pressurised.

E1 - End-position locking at both ends

| \varnothing [mm] | D1 \varnothing | D2 | H1 | L4 | L5 |
|-----------------------|---------------------|----|-------|------|------|
| 32 | 13 | M3 | 57.5 | 14 | 14 |
| 40 | 13 | M3 | 64 | 17 | 17 |
| 50 | 20 | M5 | 78.5 | 18 | 18 |
| 63 | 20 | M5 | 84.5 | 25 | 25 |
| 80 | 30 | M5 | 105 | 22 | 22 |
| 100 | 30 | M5 | 113.5 | 25.5 | 25.5 |

E2 – End-position locking with advanced piston rod

| \varnothing [mm] | D1 \varnothing | D2 | H1 | L4 |
|-----------------------|---------------------|----|-------|------|
| 32 | 13 | M3 | 57.5 | 14 |
| 40 | 13 | M3 | 64 | 17 |
| 50 | 20 | M5 | 78.5 | 18 |
| 63 | 20 | M5 | 84.5 | 25 |
| 80 | 30 | M5 | 105 | 22 |
| 100 | 30 | M5 | 113.5 | 25.5 |

E3 – End-position locking with retracted piston rod

| \varnothing [mm] | D1 \varnothing | D2 | H1 | L5 |
|-----------------------|---------------------|----|-------|------|
| 32 | 13 | M3 | 57.5 | 14 |
| 40 | 13 | M3 | 64 | 17 |
| 50 | 20 | M5 | 78.5 | 18 |
| 63 | 20 | M5 | 84.5 | 25 |
| 80 | 30 | M5 | 105 | 22 |
| 100 | 30 | M5 | 113.5 | 25.5 |

Data sheet

Dimensions – Variants

Download CAD data → www.festo.com

P2 – Bellows on the bearing cap

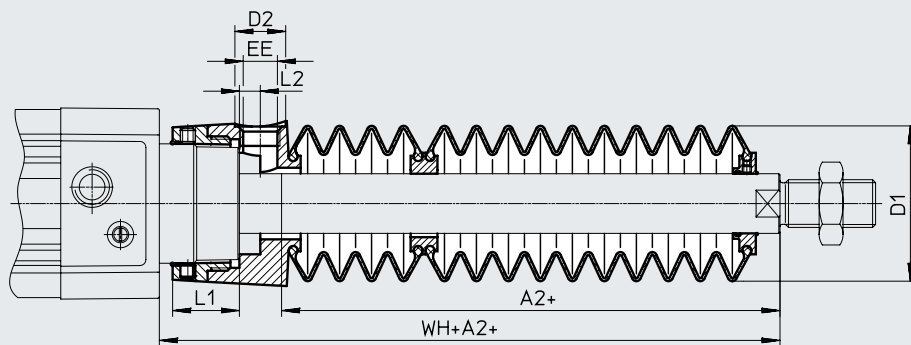

+ = plus stroke length

| ∅ Stroke [mm] | 32 | | | | | | | 40 | | | | | | |
|---------------------|------------------|------------|----|------|------|-----|-------|------------------|------------|----|------|------|-----|-------|
| | A2 ¹⁾ | D1 max. | D2 | EE | L1 | L2 | WH+A2 | A2 ¹⁾ | D1 max. | D2 | EE | L1 | L2 | WH+A2 |
| 10 ... 50 | 29 | 38 | 14 | G1/8 | 12.9 | 5.4 | 55 | 28 | 46 | 14 | G1/8 | 16.3 | 5.4 | 56.7 |
| 51 ... 125 | 47 | | | | | | 73 | 43 | | | | | | 71.7 |
| 126 ... 175 | 61 | | | | | | 87 | 56 | | | | | | 84.7 |
| 176 ... 250 | 80 | | | | | | 106 | 72 | | | | | | 100.7 |
| 251 ... 300 | 96 | | | | | | 122 | 86 | | | | | | 114.7 |
| 301 ... 350 | 112 | | | | | | 138 | 100 | | | | | | 128.7 |
| 351 ... 375 | 114 | | | | | | 140 | 101 | | | | | | 129.7 |
| 376 ... 425 | 130 | | | | | | 156 | 115 | | | | | | 143.7 |
| 426 ... 475 | 145 | | | | | | 171 | 130 | | | | | | 158.7 |
| 476 ... 500 | 147 | | | | | | 173 | 131 | | | | | | 159.7 |

| ∅ Stroke [mm] | 50 | | | | | | | 63 | | | | | | |
|---------------------|------------------|------------|----|------|-------|----|-------|------------------|------------|----|------|------|----|-------|
| | A2 ¹⁾ | D1 max. | D2 | EE | L1 | L2 | WH+A2 | A2 ¹⁾ | D1 max. | D2 | EE | L1 | L2 | WH+A2 |
| 10 ... 50 | 28 | 57 | 17 | G1/4 | 22.35 | 7 | 63.6 | 28 | 57 | 17 | G1/4 | 22.4 | 7 | 63.9 |
| 51 ... 125 | 46 | | | | | | 81.6 | 46 | | | | | | 81.9 |
| 126 ... 175 | 56 | | | | | | 91.6 | 56 | | | | | | 91.9 |
| 176 ... 250 | 73 | | | | | | 108.6 | 73 | | | | | | 108.9 |
| 251 ... 300 | 86 | | | | | | 121.6 | 86 | | | | | | 121.9 |
| 301 ... 350 | 97 | | | | | | 132.6 | 97 | | | | | | 132.9 |
| 351 ... 375 | 105 | | | | | | 140.6 | 105 | | | | | | 140.9 |
| 376 ... 425 | 116 | | | | | | 151.6 | 116 | | | | | | 151.9 |
| 426 ... 475 | 126 | | | | | | 161.6 | 126 | | | | | | 161.9 |
| 476 ... 500 | 134 | | | | | | 169.6 | 134 | | | | | | 169.9 |

1) The dimension corresponds to the E value (piston rod extension) of the drive

Data sheet

| ∅ Stroke [mm] | 80 | | | | | | | 100 | | | | | | |
|---------------------|------------------|------------|----|------|----|----|-------|------------------|------------|----|------|----|----|-------|
| | A2 ¹⁾ | D1 max. | D2 | EE | L1 | L2 | WH+A2 | A2 ¹⁾ | D1 max. | D2 | EE | L1 | L2 | WH+A2 |
| 10 ... 50 | 25 | 93 | 17 | G1/4 | 28 | 4 | 70.4 | 25 | 93 | 17 | G1/4 | 28 | 4 | 74.3 |
| 51 ... 125 | 37 | | | | | | 82.4 | 37 | | | | | | 86.3 |
| 126 ... 175 | 49 | | | | | | 94.4 | 49 | | | | | | 98.3 |
| 176 ... 250 | 62 | | | | | | 107.4 | 62 | | | | | | 111.3 |
| 251 ... 300 | 74 | | | | | | 119.4 | 74 | | | | | | 123.3 |
| 301 ... 350 | 86 | | | | | | 131.4 | 86 | | | | | | 135.3 |
| 351 ... 375 | 87 | | | | | | 132.4 | 87 | | | | | | 136.3 |
| 376 ... 425 | 98 | | | | | | 143.4 | 98 | | | | | | 147.3 |
| 426 ... 475 | 110 | | | | | | 155.4 | 110 | | | | | | 159.3 |
| 476 ... 500 | 111 | | | | | | 156.4 | 111 | | | | | | 160.3 |

1) The dimension corresponds to the E value (piston rod extension) of the drive

Data sheet

| Ordering data | | | | With PPS cushioning | |
|----------------------|-------------|---------------------|---------------------|---------------------|---------------------|
| Piston diameter [mm] | Stroke [mm] | With PPV cushioning | | With PPS cushioning | |
| | | Part no. | Type | Part no. | Type |
| 32 | 20 | ★ 2123069 | DSBC-32-20-PPVA-N3 | ★ 2123085 | DSBC-32-20-PPSA-N3 |
| | 25 | ★ 1376422 | DSBC-32-25-PPVA-N3 | ★ 1376467 | DSBC-32-25-PPSA-N3 |
| | 30 | ★ 2123070 | DSBC-32-30-PPVA-N3 | ★ 2123086 | DSBC-32-30-PPSA-N3 |
| | 40 | ★ 1376423 | DSBC-32-40-PPVA-N3 | ★ 1376468 | DSBC-32-40-PPSA-N3 |
| | 50 | ★ 1376424 | DSBC-32-50-PPVA-N3 | ★ 1376469 | DSBC-32-50-PPSA-N3 |
| | 60 | ★ 2123071 | DSBC-32-60-PPVA-N3 | ★ 2123087 | DSBC-32-60-PPSA-N3 |
| | 70 | ★ 2123072 | DSBC-32-70-PPVA-N3 | ★ 2123088 | DSBC-32-70-PPSA-N3 |
| | 80 | ★ 1376425 | DSBC-32-80-PPVA-N3 | ★ 1376470 | DSBC-32-80-PPSA-N3 |
| | 100 | ★ 1376426 | DSBC-32-100-PPVA-N3 | ★ 1376471 | DSBC-32-100-PPSA-N3 |
| | 125 | ★ 1376427 | DSBC-32-125-PPVA-N3 | ★ 1376472 | DSBC-32-125-PPSA-N3 |
| | 150 | ★ 2123073 | DSBC-32-150-PPVA-N3 | ★ 2123089 | DSBC-32-150-PPSA-N3 |
| | 160 | ★ 1376428 | DSBC-32-160-PPVA-N3 | ★ 1376473 | DSBC-32-160-PPSA-N3 |
| | 200 | ★ 1376429 | DSBC-32-200-PPVA-N3 | ★ 1376474 | DSBC-32-200-PPSA-N3 |
| | 250 | ★ 1376430 | DSBC-32-250-PPVA-N3 | ★ 1376475 | DSBC-32-250-PPSA-N3 |
| | 300 | ★ 2123074 | DSBC-32-300-PPVA-N3 | ★ 2123090 | DSBC-32-300-PPSA-N3 |
| | 320 | ★ 1376431 | DSBC-32-320-PPVA-N3 | ★ 1376476 | DSBC-32-320-PPSA-N3 |
| | 400 | ★ 1376432 | DSBC-32-400-PPVA-N3 | ★ 1376477 | DSBC-32-400-PPSA-N3 |
| 500 | ★ 1376433 | DSBC-32-500-PPVA-N3 | ★ 1376478 | DSBC-32-500-PPSA-N3 | |
| 40 | 20 | ★ 2123166 | DSBC-40-20-PPVA-N3 | ★ 2123780 | DSBC-40-20-PPSA-N3 |
| | 25 | ★ 1376656 | DSBC-40-25-PPVA-N3 | ★ 1376903 | DSBC-40-25-PPSA-N3 |
| | 30 | ★ 2123167 | DSBC-40-30-PPVA-N3 | ★ 2123781 | DSBC-40-30-PPSA-N3 |
| | 40 | ★ 1376657 | DSBC-40-40-PPVA-N3 | ★ 1376904 | DSBC-40-40-PPSA-N3 |
| | 50 | ★ 1376658 | DSBC-40-50-PPVA-N3 | ★ 1376905 | DSBC-40-50-PPSA-N3 |
| | 60 | ★ 2123224 | DSBC-40-60-PPVA-N3 | ★ 2123782 | DSBC-40-60-PPSA-N3 |
| | 70 | ★ 2123225 | DSBC-40-70-PPVA-N3 | ★ 2123783 | DSBC-40-70-PPSA-N3 |
| | 80 | ★ 1376659 | DSBC-40-80-PPVA-N3 | ★ 1376906 | DSBC-40-80-PPSA-N3 |
| | 100 | ★ 1376660 | DSBC-40-100-PPVA-N3 | ★ 1376907 | DSBC-40-100-PPSA-N3 |
| | 125 | ★ 1376661 | DSBC-40-125-PPVA-N3 | ★ 1376908 | DSBC-40-125-PPSA-N3 |
| | 150 | ★ 2123226 | DSBC-40-150-PPVA-N3 | ★ 2123784 | DSBC-40-150-PPSA-N3 |
| | 160 | ★ 1376662 | DSBC-40-160-PPVA-N3 | ★ 1376909 | DSBC-40-160-PPSA-N3 |
| | 200 | ★ 1376663 | DSBC-40-200-PPVA-N3 | ★ 1376910 | DSBC-40-200-PPSA-N3 |
| | 250 | ★ 1376664 | DSBC-40-250-PPVA-N3 | ★ 1376911 | DSBC-40-250-PPSA-N3 |
| | 300 | ★ 2123227 | DSBC-40-300-PPVA-N3 | ★ 2123785 | DSBC-40-300-PPSA-N3 |
| | 320 | ★ 1376665 | DSBC-40-320-PPVA-N3 | ★ 1376912 | DSBC-40-320-PPSA-N3 |
| | 400 | ★ 1376666 | DSBC-40-400-PPVA-N3 | ★ 1376913 | DSBC-40-400-PPSA-N3 |
| 500 | ★ 1376667 | DSBC-40-500-PPVA-N3 | ★ 1376914 | DSBC-40-500-PPSA-N3 | |

 Note

Other variants in the modular product system → page 32

Data sheet

| Ordering data | | | | | |
|----------------------|-------------|---------------------|---------------------|---------------------|---------------------|
| Piston diameter [mm] | Stroke [mm] | With PPV cushioning | | With PPS cushioning | |
| | | Part no. | Type | Part no. | Type |
| 50 | 20 | ★ 2098969 | DSBC-50-20-PPVA-N3 | ★ 2102628 | DSBC-50-20-PPSA-N3 |
| | 25 | ★ 1366948 | DSBC-50-25-PPVA-N3 | ★ 1376301 | DSBC-50-25-PPSA-N3 |
| | 30 | ★ 2098970 | DSBC-50-30-PPVA-N3 | ★ 2102629 | DSBC-50-30-PPSA-N3 |
| | 40 | ★ 1366949 | DSBC-50-40-PPVA-N3 | ★ 1376304 | DSBC-50-40-PPSA-N3 |
| | 50 | ★ 1366950 | DSBC-50-50-PPVA-N3 | ★ 1376305 | DSBC-50-50-PPSA-N3 |
| | 60 | ★ 2098972 | DSBC-50-60-PPVA-N3 | ★ 2102630 | DSBC-50-60-PPSA-N3 |
| | 70 | ★ 2098973 | DSBC-50-70-PPVA-N3 | ★ 2102631 | DSBC-50-70-PPSA-N3 |
| | 80 | ★ 1366951 | DSBC-50-80-PPVA-N3 | ★ 1376306 | DSBC-50-80-PPSA-N3 |
| | 100 | ★ 1366952 | DSBC-50-100-PPVA-N3 | ★ 1376307 | DSBC-50-100-PPSA-N3 |
| | 125 | ★ 1366953 | DSBC-50-125-PPVA-N3 | ★ 1376308 | DSBC-50-125-PPSA-N3 |
| | 150 | ★ 2098974 | DSBC-50-150-PPVA-N3 | ★ 2102632 | DSBC-50-150-PPSA-N3 |
| | 160 | ★ 1366954 | DSBC-50-160-PPVA-N3 | ★ 1376309 | DSBC-50-160-PPSA-N3 |
| | 200 | ★ 1366955 | DSBC-50-200-PPVA-N3 | ★ 1376310 | DSBC-50-200-PPSA-N3 |
| | 250 | ★ 1366956 | DSBC-50-250-PPVA-N3 | ★ 1376311 | DSBC-50-250-PPSA-N3 |
| | 300 | ★ 2098975 | DSBC-50-300-PPVA-N3 | ★ 2102633 | DSBC-50-300-PPSA-N3 |
| | 320 | ★ 1366957 | DSBC-50-320-PPVA-N3 | ★ 1376312 | DSBC-50-320-PPSA-N3 |
| 400 | ★ 1366958 | DSBC-50-400-PPVA-N3 | ★ 1376313 | DSBC-50-400-PPSA-N3 | |
| 500 | ★ 1366959 | DSBC-50-500-PPVA-N3 | ★ 1376314 | DSBC-50-500-PPSA-N3 | |
| 63 | 20 | ★ 2125490 | DSBC-63-20-PPVA-N3 | ★ 2126684 | DSBC-63-20-PPSA-N3 |
| | 25 | ★ 1383578 | DSBC-63-25-PPVA-N3 | ★ 1383632 | DSBC-63-25-PPSA-N3 |
| | 30 | ★ 2125491 | DSBC-63-30-PPVA-N3 | ★ 2126685 | DSBC-63-30-PPSA-N3 |
| | 40 | ★ 1383579 | DSBC-63-40-PPVA-N3 | ★ 1383633 | DSBC-63-40-PPSA-N3 |
| | 50 | ★ 1383580 | DSBC-63-50-PPVA-N3 | ★ 1383634 | DSBC-63-50-PPSA-N3 |
| | 60 | ★ 2125492 | DSBC-63-60-PPVA-N3 | ★ 2126686 | DSBC-63-60-PPSA-N3 |
| | 70 | ★ 2125493 | DSBC-63-70-PPVA-N3 | ★ 2126687 | DSBC-63-70-PPSA-N3 |
| | 80 | ★ 1383581 | DSBC-63-80-PPVA-N3 | ★ 1383635 | DSBC-63-80-PPSA-N3 |
| | 100 | ★ 1383582 | DSBC-63-100-PPVA-N3 | ★ 1383636 | DSBC-63-100-PPSA-N3 |
| | 125 | ★ 1383583 | DSBC-63-125-PPVA-N3 | ★ 1383637 | DSBC-63-125-PPSA-N3 |
| | 150 | ★ 2125494 | DSBC-63-150-PPVA-N3 | ★ 2126688 | DSBC-63-150-PPSA-N3 |
| | 160 | ★ 1383584 | DSBC-63-160-PPVA-N3 | ★ 1383638 | DSBC-63-160-PPSA-N3 |
| | 200 | ★ 1383585 | DSBC-63-200-PPVA-N3 | ★ 1383639 | DSBC-63-200-PPSA-N3 |
| | 250 | ★ 1383586 | DSBC-63-250-PPVA-N3 | ★ 1383640 | DSBC-63-250-PPSA-N3 |
| | 300 | ★ 2125495 | DSBC-63-300-PPVA-N3 | ★ 2126689 | DSBC-63-300-PPSA-N3 |
| | 320 | ★ 1383587 | DSBC-63-320-PPVA-N3 | ★ 1383641 | DSBC-63-320-PPSA-N3 |
| 400 | ★ 1383588 | DSBC-63-400-PPVA-N3 | ★ 1383642 | DSBC-63-400-PPSA-N3 | |
| 500 | ★ 1383589 | DSBC-63-500-PPVA-N3 | ★ 1383643 | DSBC-63-500-PPSA-N3 | |

 Note

Other variants in the modular product system → page 32

Data sheet

| Ordering data | | | | | |
|-------------------------|----------------|---------------------|---------------------|---------------------|---------------------|
| Piston diameter [mm] | Stroke [mm] | With PPV cushioning | | With PPS cushioning | |
| | | Part no. | Type | Part no. | Type |
| 80 | 20 | ★ 2126594 | DSBC-80-20-PPVA-N3 | ★ 2126636 | DSBC-80-20-PPSA-N3 |
| | 25 | ★ 1383333 | DSBC-80-25-PPVA-N3 | ★ 1383366 | DSBC-80-25-PPSA-N3 |
| | 30 | ★ 2126595 | DSBC-80-30-PPVA-N3 | ★ 2126637 | DSBC-80-30-PPSA-N3 |
| | 40 | ★ 1383334 | DSBC-80-40-PPVA-N3 | ★ 1383367 | DSBC-80-40-PPSA-N3 |
| | 50 | ★ 1383335 | DSBC-80-50-PPVA-N3 | ★ 1383368 | DSBC-80-50-PPSA-N3 |
| | 60 | ★ 2126597 | DSBC-80-60-PPVA-N3 | ★ 2126638 | DSBC-80-60-PPSA-N3 |
| | 70 | ★ 2126598 | DSBC-80-70-PPVA-N3 | ★ 2126639 | DSBC-80-70-PPSA-N3 |
| | 80 | ★ 1383336 | DSBC-80-80-PPVA-N3 | ★ 1383369 | DSBC-80-80-PPSA-N3 |
| | 100 | ★ 1383337 | DSBC-80-100-PPVA-N3 | ★ 1383370 | DSBC-80-100-PPSA-N3 |
| | 125 | ★ 1383338 | DSBC-80-125-PPVA-N3 | ★ 1383371 | DSBC-80-125-PPSA-N3 |
| | 150 | ★ 2126599 | DSBC-80-150-PPVA-N3 | ★ 2126640 | DSBC-80-150-PPSA-N3 |
| | 160 | ★ 1383339 | DSBC-80-160-PPVA-N3 | ★ 1383372 | DSBC-80-160-PPSA-N3 |
| | 200 | ★ 1383340 | DSBC-80-200-PPVA-N3 | ★ 1383373 | DSBC-80-200-PPSA-N3 |
| | 250 | ★ 1383341 | DSBC-80-250-PPVA-N3 | ★ 1383374 | DSBC-80-250-PPSA-N3 |
| | 300 | ★ 2126600 | DSBC-80-300-PPVA-N3 | ★ 2126641 | DSBC-80-300-PPSA-N3 |
| | 320 | ★ 1383342 | DSBC-80-320-PPVA-N3 | ★ 1383375 | DSBC-80-320-PPSA-N3 |
| | 400 | ★ 1383343 | DSBC-80-400-PPVA-N3 | ★ 1383376 | DSBC-80-400-PPSA-N3 |
| 500 | ★ 1383344 | DSBC-80-500-PPVA-N3 | ★ 1383377 | DSBC-80-500-PPSA-N3 | |

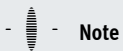
**Note**

Other variants in the modular product system → page 32

Data sheet

| Ordering data | | | | | |
|-------------------------|----------------|----------------------|----------------------|----------------------|----------------------|
| Piston diameter [mm] | Stroke [mm] | With PPV cushioning | | With PPS cushioning | |
| | | Part no. | Type | Part no. | Type |
| 32 | 1 ... 2800 | 1463254 | DSBC-32-...-PPVA-N3 | 1463252 | DSBC-32-...-PPSA-N3 |
| 40 | 1 ... 2800 | 1462834 | DSBC-40-...-PPVA-N3 | 1462835 | DSBC-40-...-PPSA-N3 |
| 50 | 1 ... 2800 | 1463766 | DSBC-50-...-PPVA-N3 | 1463768 | DSBC-50-...-PPSA-N3 |
| 63 | 1 ... 2800 | 1463483 | DSBC-63-...-PPVA-N3 | 1463481 | DSBC-63-...-PPSA-N3 |
| 80 | 1 ... 2800 | 1463504 | DSBC-80-...-PPVA-N3 | 1463500 | DSBC-80-...-PPSA-N3 |
| 100 | 25 | 1384804 | DSBC-100-25-PPVA-N3 | 1384890 | DSBC-100-25-PPSA-N3 |
| | 40 | 1384805 | DSBC-100-40-PPVA-N3 | 1384891 | DSBC-100-40-PPSA-N3 |
| | 50 | 1384806 | DSBC-100-50-PPVA-N3 | 1384892 | DSBC-100-50-PPSA-N3 |
| | 80 | 1384807 | DSBC-100-80-PPVA-N3 | 1384893 | DSBC-100-80-PPSA-N3 |
| | 100 | 1384808 | DSBC-100-100-PPVA-N3 | 1384894 | DSBC-100-100-PPSA-N3 |
| | 125 | 1384809 | DSBC-100-125-PPVA-N3 | 1384895 | DSBC-100-125-PPSA-N3 |
| | 160 | 1384810 | DSBC-100-160-PPVA-N3 | 1384896 | DSBC-100-160-PPSA-N3 |
| | 200 | 1384811 | DSBC-100-200-PPVA-N3 | 1384897 | DSBC-100-200-PPSA-N3 |
| | 250 | 1384812 | DSBC-100-250-PPVA-N3 | 1384898 | DSBC-100-250-PPSA-N3 |
| | 320 | 1384813 | DSBC-100-320-PPVA-N3 | 1384899 | DSBC-100-320-PPSA-N3 |
| | 400 | 1384814 | DSBC-100-400-PPVA-N3 | 1384900 | DSBC-100-400-PPSA-N3 |
| 500 | 1384815 | DSBC-100-500-PPVA-N3 | 1384901 | DSBC-100-500-PPSA-N3 | |
| 1 ... 2800 | 1463598 | DSBC-100-...-PPVA-N3 | 1463558 | DSBC-100-...-PPSA-N3 | |
| 125 | 25 | 1804956 | DSBC-125-25-PPVA-N3 | 1804661 | DSBC-125-25-PPSA-N3 |
| | 40 | 1804957 | DSBC-125-40-PPVA-N3 | 1804662 | DSBC-125-40-PPSA-N3 |
| | 50 | 1804958 | DSBC-125-50-PPVA-N3 | 1804663 | DSBC-125-50-PPSA-N3 |
| | 80 | 1804959 | DSBC-125-80-PPVA-N3 | 1804664 | DSBC-125-80-PPSA-N3 |
| | 100 | 1804960 | DSBC-125-100-PPVA-N3 | 1804665 | DSBC-125-100-PPSA-N3 |
| | 125 | 1804961 | DSBC-125-125-PPVA-N3 | 1804666 | DSBC-125-125-PPSA-N3 |
| | 160 | 1804962 | DSBC-125-160-PPVA-N3 | 1804667 | DSBC-125-160-PPSA-N3 |
| | 200 | 1804963 | DSBC-125-200-PPVA-N3 | 1804668 | DSBC-125-200-PPSA-N3 |
| | 250 | 1804964 | DSBC-125-250-PPVA-N3 | 1804669 | DSBC-125-250-PPSA-N3 |
| | 320 | 1804965 | DSBC-125-320-PPVA-N3 | 1804671 | DSBC-125-320-PPSA-N3 |
| | 400 | 1804966 | DSBC-125-400-PPVA-N3 | 1804672 | DSBC-125-400-PPSA-N3 |
| | 500 | 1804967 | DSBC-125-500-PPVA-N3 | 1804673 | DSBC-125-500-PPSA-N3 |
| | 1 ... 2800 | 1755348 | DSBC-125-...-PPVA-N3 | 1755619 | DSBC-125-...-PPSA-N3 |

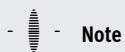
**Note**

Other variants in the modular product system → page 32

Ordering data – Modular product system

| Ordering table | | | | | | | | | | | |
|-----------------------------|---|---------|---------|---------|---------|---------|---------|------------|--------|------------|---|
| Size | 32 | 40 | 50 | 63 | 80 | 100 | 125 | Conditions | Code | Enter code | |
| Module no. | 1463250 | 1461995 | 1463770 | 1463475 | 1463495 | 1463520 | 1722457 | | | | |
| Function | Standards-based cylinder, double-acting, based on ISO 15552 | | | | | | | | DSBC | DSBC | |
| Protection against rotation | None | | | | | | | | ★ | | |
| | With protection against rotation | | | | | | | - | [1] | ★ -Q | |
| Running characteristics | Standard | | | | | | | | | ★ | |
| | Low friction | | | | | | | - | [2] | L | |
| | Constant, slow movement | | | | | | | | [2] | U | |
| | Low friction for balancer applications | | | | | | | | [3] | L1 | |
| Piston diameter [mm] | 32 | 40 | 50 | 63 | 80 | 100 | 125 | | ★ -... | | |
| Stroke [mm] | 1 ... 2800 | | | | | | | | | ★ -... | |
| Piston rod type | At one end | | | | | | | | | ★ | |
| | Through piston rod | | | | | | | | | ★ -T | |
| Piston rod thread type | Male thread | | | | | | | | | ★ | |
| | Female thread | | | | | | | | [4] | ★ F | |
| Profile type | Sensor slot on 1 side | | | | | | | | | ★ | |
| | Sensor slot on 3 sides | | | | | | | | | ★ D3 | |
| Cushioning | Elastic cushioning rings/plates at both ends | | | | | | | | [5] | -P | |
| | Pneumatic cushioning, self-adjusting at both ends | | | | | | | | [6] | ★ -PPS | |
| | Pneumatic cushioning, adjustable at both ends | | | | | | | | | ★ -PPV | |
| Position sensing | Via proximity switch | | | | | | | | | ★ A | A |

[1] **Q** Not with L, U, L1, N3, T3, T4, P2, A1, A2, A3, A6
Only up to a stroke of 1500 mm

[2] **L, U** Not with T, R3, T1, T3, T4, P2, A1, A2, A3, A6, EX4

[3] **L1** Not with T, PPV, R3, T1, T3, T4, P2, A1, A2, A3, A6, EX4

[4] **F** Not with ...L

[5] **P** Not with A1

[6] **PPS** Not with T1, T3, T4, A1

 - **Note**

If feature L is used in combination with transverse loads or strokes of above 500 mm, suitable measures must be taken to support the piston rod. The operating pressure (→ page 12) is applicable for strokes up to 500 mm.

 - **Note**

If feature L1 is used in combination with strokes of above 500 mm, suitable measures must be taken to support the piston rod. The operating pressure (→ page 12) is applicable for strokes up to 500 mm.

Ordering data – Modular product system

| Ordering table | | | | | | | | | | |
|------------------------------|-------------------------------|-------------------------------------|----|----------|----|-----|-----|------------|---------|------------|
| Size | 32 | 40 | 50 | 63 | 80 | 100 | 125 | Conditions | Code | Enter code |
| Standard | Based on ISO 15552 | | | | | | | | ★ | |
| | Corresponds to ISO 15552 | | | | | | | | ★ -N3 | |
| Corrosion protection | Standard | | | | | | | | ★ | |
| | High corrosion protection | | | | | | | [7] | ★ R3 | |
| Temperature range | Standard | | | | | | | | ★ | |
| | [°C] | Heat-resistant seals up to max. 120 | | | | | | [8] | ★ T1 | |
| | [°C] | -40 ... +80 | | | | | | [8] | T3 | |
| | [°C] | 0 ... +150 | | | | | | [8] | T4 | |
| Protection against particles | Standard | | | | | | | | ★ | |
| | Bellows on bearing cap | | | | | | - | [9] | P2 | |
| Scraper variant | None | | | | | | | | ★ | |
| | Increased chemical resistance | | | | | | | | A1 | |
| | Hard scraper | | | | | | | | A2 | |
| | For unlubricated operation | | | | | | | | A3 | |
| | Metal scraper | | | | | | | | A6 | |
| EU certification | None | | | | | | | | ★ | |
| | [mm] | II 2GD | | | | | | [10] | EX4 | |
| Piston rod extension | None | | | | | | | | | |
| | [mm] | 1 ... 500 | | | | | | [11] | ★ -...E | |
| Piston rod thread extension | None | | | | | | | | | |
| | [mm] | 1 ... 35 | | 1 ... 70 | | | | [11] | -...L | |

[7] **R3** Not with A2, A6

[8] **T1, T3, T4** Not with P2, A1, A2, A3, EX4

[9] **P2** Not with N3, A1, A2, A3, A6, EX4
Only for strokes of 10 ... 500 mm

[10] **EX4** Not with T1, T3, T4, P2, A1, A3, A6

[11] **E, ...L** Only up to a stroke of 2000 mm

 - **Note**

The piston rod extension for the bellows is automatically taken into consideration when feature P2 is selected. This means that there is no need to specify a value for feature ...E.

 - **Note**

When selecting feature ...E in combination with feature P2, the extended part of the piston rod ...E is not covered by the bellows.

 - **Note**

When feature P2 is selected in combination with feature T (through piston rod), the bellows is mounted at one end only.

Ordering data – Modular product system

| Ordering table | | | | | | | | | | | |
|----------------------------------|---|----------------|----------------|----------------|----------------|----------------|----------------|------------|--------|------------|---|
| Size | 32 | 40 | 50 | 63 | 80 | 100 | 125 | Conditions | Code | Enter code | |
| Module no. | 1463250 | 1461995 | 1463770 | 1463475 | 1463495 | 1463520 | 1722457 | | | | |
| Function | Standards-based cylinder, double-acting, based on ISO 15552 | | | | | | | | DSBC | DSBC | |
| Protection against rotation | None | | | | | | | | ★ | | |
| | With protection against rotation | | | | | | | – | [1] | ★ -Q | |
| Piston diameter [mm] | 32 | 40 | 50 | 63 | 80 | 100 | 125 | | ★ -... | | |
| Stroke [mm] | 10 ... 2000 | | | | | | | | | ★ -... | |
| Clamping unit | Attached | | | | | | | | | ★ -C | C |
| Piston rod type | At one end | | | | | | | | | ★ | |
| | Through piston rod | | | | | | | | | ★ T | |
| Piston rod thread type | Male thread | | | | | | | | | ★ | |
| | Female thread | | | | | | | | [2] | ★ F | |
| Profile type | Sensor slot on 1 side | | | | | | | | | ★ | |
| | Sensor slot on 3 sides | | | | | | | | | ★ D3 | |
| Cushioning | Elastic cushioning rings/plates at both ends | | | | | | | | | -P | |
| | Pneumatic cushioning, self-adjusting at both ends | | | | | | | | | ★ -PPS | |
| | Pneumatic cushioning, adjustable at both ends | | | | | | | | | ★ -PPV | |
| Position sensing | Via proximity switch | | | | | | | | | ★ A | A |
| Piston rod extension [mm] | None | | | | | | | | | | |
| | 1 ... 500 | | | | | | | | | ★ -...E | |
| Piston rod thread extension [mm] | None | | | | | | | | | | |
| | 1 ... 35 | | | 1 ... 70 | | | | | | -...L | |

[1] **Q** Only available with T.
Only up to a stroke of 1500 mm

[2] **F** Not with ...L

Ordering data – Modular product system

| Ordering table | | | | | | | | | | |
|----------------------------------|---|----------------|----------------|----------------|----------------|----------------|------------|------|--------------|------|
| Size | 32 | 40 | 50 | 63 | 80 | 100 | Conditions | Code | Enter code | |
| Module no. | 1463250 | 1461995 | 1463770 | 1463475 | 1463495 | 1463520 | | | | |
| Function | Standards-based cylinder, double-acting, based on ISO 15552 | | | | | | | | DSBC | DSBC |
| Piston diameter [mm] | 32 | 40 | 50 | 63 | 80 | 100 | | -... | | |
| Stroke [mm] | 10 ... 2000 | | | | | | | | -... | |
| End-position locking | At both ends | | | | | | | | E1 | |
| | With advanced piston rod | | | | | | | | E2 | |
| | With retracted piston rod | | | | | | | | E3 | |
| Piston rod thread type | Male thread | | | | | | | | | |
| | Female thread | | | | | | [1] | | F | |
| Profile type | Sensor slot on 1 side | | | | | | | | | |
| | Sensor slot on 3 sides | | | | | | | | D3 | |
| Cushioning | Elastic cushioning rings/plates at both ends | | | | | | | | -P | |
| | Pneumatic cushioning, adjustable at both ends | | | | | | | | -PPV | |
| Position sensing | Via proximity switch | | | | | | | | A | A |
| Piston rod extension [mm] | None | | | | | | | | | |
| | 1 ... 500 | | | | | | | | -...E | |
| Piston rod thread extension [mm] | None | | | | | | | | | |
| | 1 ... 35 | | 1 ... 70 | | | | | | -...L | |

1) **F** Not with ...L

Ordering data – Modular product system

| Ordering table | | | | | | | | | | | |
|----------------------------------|---|---------|---------|---------|---------|---------|---------|------------|-------------|--------------|-----|
| Size | 32 | 40 | 50 | 63 | 80 | 100 | 125 | Conditions | Code | Enter code | |
| Module no. | 8150687 | 8150688 | 8150689 | 8150690 | 8150691 | 8150692 | 8150693 | | | | |
| Function | Standards-based cylinder, double-acting, based on ISO 15552 | | | | | | | | DSBC | DSBC | |
| Piston diameter [mm] | 32 | 40 | 50 | 63 | 80 | 100 | 125 | | -... | | |
| Stroke [mm] | 1 ... 2800 | | | | | | | | | -... | |
| Piston rod type | At one end | | | | | | | | | | |
| | Through piston rod | | | | | | | | | T | |
| Piston rod thread type | Male thread | | | | | | | | | | |
| | Female thread | | | | | | | [1] | | F | |
| Profile type | Sensor slot on 1 side | | | | | | | | | | |
| | Sensor slot on 3 sides | | | | | | | | | D3 | |
| Cushioning | Elastic cushioning rings/plates at both ends | | | | | | | | | -P | |
| | Pneumatic cushioning, self-adjusting at both ends | | | | | | | | | -PPS | |
| | Pneumatic cushioning, adjustable at both ends | | | | | | | | | -PPV | |
| Position sensing | Via proximity switch | | | | | | | | | A | A |
| Standard | Based on ISO 15552 | | | | | | | | | | |
| | Corresponds to ISO 15552 | | | | | | | | | -N3 | |
| Special material properties | Recommended for production plants for manufacturing lithium-ion batteries (Cu≤1%, Zn≤1%, Ni≤1%) | | | | | | | | | F1A | F1A |
| Piston rod extension [mm] | None | | | | | | | | | | |
| | 1 ... 500 | | | | | | | [1] | | -...E | |
| Piston rod thread extension [mm] | None | | | | | | | | | | |
| | 1 ... 70 | | | | | | | [1] [2] | | -...L | |

[1] **F, ...E, ...L** Not with N3[2] **...L** Not with F

Data sheet

Ordering data – Versions for DSBC-...D3 (sensor slots on 3 sides)

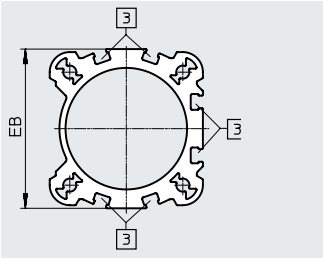

In this version, the piston position can be sensed on 3 sides of the drive.

[3] Sensor slot for proximity switch

| Piston diameter [mm] | Stroke [mm] | With PPV cushioning | | With PPS cushioning | |
|----------------------|-------------|------------------------|------------------------|------------------------|------------------------|
| | | Part no. | Type | Part no. | Type |
| 32 | 20 | 3656511 | DSBC-32-20-D3-PPVA-N3 | 3659374 | DSBC-32-20-D3-PPSA-N3 |
| | 25 | 3656512 | DSBC-32-25-D3-PPVA-N3 | 3659375 | DSBC-32-25-D3-PPSA-N3 |
| | 30 | 3656513 | DSBC-32-30-D3-PPVA-N3 | 3659376 | DSBC-32-30-D3-PPSA-N3 |
| | 40 | 3656514 | DSBC-32-40-D3-PPVA-N3 | 3659377 | DSBC-32-40-D3-PPSA-N3 |
| | 50 | 3656515 | DSBC-32-50-D3-PPVA-N3 | 3659378 | DSBC-32-50-D3-PPSA-N3 |
| | 60 | 3656516 | DSBC-32-60-D3-PPVA-N3 | 3659379 | DSBC-32-60-D3-PPSA-N3 |
| | 70 | 3656517 | DSBC-32-70-D3-PPVA-N3 | 3659380 | DSBC-32-70-D3-PPSA-N3 |
| | 80 | 3656518 | DSBC-32-80-D3-PPVA-N3 | 3659381 | DSBC-32-80-D3-PPSA-N3 |
| | 100 | 3656519 | DSBC-32-100-D3-PPVA-N3 | 3659382 | DSBC-32-100-D3-PPSA-N3 |
| | 125 | 3656520 | DSBC-32-125-D3-PPVA-N3 | 3659383 | DSBC-32-125-D3-PPSA-N3 |
| | 150 | 3656521 | DSBC-32-150-D3-PPVA-N3 | 3659384 | DSBC-32-150-D3-PPSA-N3 |
| | 160 | 3656522 | DSBC-32-160-D3-PPVA-N3 | 3659385 | DSBC-32-160-D3-PPSA-N3 |
| | 200 | 3656523 | DSBC-32-200-D3-PPVA-N3 | 3659386 | DSBC-32-200-D3-PPSA-N3 |
| | 250 | 3656524 | DSBC-32-250-D3-PPVA-N3 | 3659387 | DSBC-32-250-D3-PPSA-N3 |
| 300 | 3656525 | DSBC-32-300-D3-PPVA-N3 | 3659388 | DSBC-32-300-D3-PPSA-N3 | |
| 320 | 3656526 | DSBC-32-320-D3-PPVA-N3 | 3659389 | DSBC-32-320-D3-PPSA-N3 | |
| 40 | 20 | 3660615 | DSBC-40-20-D3-PPVA-N3 | 3660759 | DSBC-40-20-D3-PPSA-N3 |
| | 25 | 3660616 | DSBC-40-25-D3-PPVA-N3 | 3660760 | DSBC-40-25-D3-PPSA-N3 |
| | 30 | 3660617 | DSBC-40-30-D3-PPVA-N3 | 3660761 | DSBC-40-30-D3-PPSA-N3 |
| | 40 | 3660618 | DSBC-40-40-D3-PPVA-N3 | 3660762 | DSBC-40-40-D3-PPSA-N3 |
| | 50 | 3660619 | DSBC-40-50-D3-PPVA-N3 | 3660763 | DSBC-40-50-D3-PPSA-N3 |
| | 60 | 3660620 | DSBC-40-60-D3-PPVA-N3 | 3660764 | DSBC-40-60-D3-PPSA-N3 |
| | 70 | 3660621 | DSBC-40-70-D3-PPVA-N3 | 3660765 | DSBC-40-70-D3-PPSA-N3 |
| | 80 | 3660622 | DSBC-40-80-D3-PPVA-N3 | 3660766 | DSBC-40-80-D3-PPSA-N3 |
| | 100 | 3660623 | DSBC-40-100-D3-PPVA-N3 | 3660767 | DSBC-40-100-D3-PPSA-N3 |
| | 125 | 3660624 | DSBC-40-125-D3-PPVA-N3 | 3660768 | DSBC-40-125-D3-PPSA-N3 |
| | 150 | 3660625 | DSBC-40-150-D3-PPVA-N3 | 3660769 | DSBC-40-150-D3-PPSA-N3 |
| | 160 | 3660626 | DSBC-40-160-D3-PPVA-N3 | 3660770 | DSBC-40-160-D3-PPSA-N3 |
| | 200 | 3660627 | DSBC-40-200-D3-PPVA-N3 | 3660771 | DSBC-40-200-D3-PPSA-N3 |
| | 250 | 3660628 | DSBC-40-250-D3-PPVA-N3 | 3660772 | DSBC-40-250-D3-PPSA-N3 |
| 300 | 3660629 | DSBC-40-300-D3-PPVA-N3 | 3660773 | DSBC-40-300-D3-PPSA-N3 | |
| 320 | 3660630 | DSBC-40-320-D3-PPVA-N3 | 3660774 | DSBC-40-320-D3-PPSA-N3 | |

Data sheet

Ordering data – Versions for DSBC-...D3 (sensor slots on 3 sides)

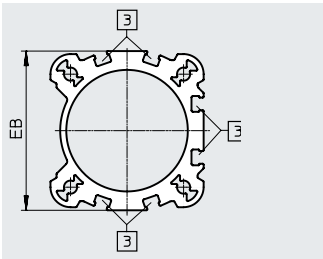

In this version, the piston position can be sensed on 3 sides of the drive.

[3] Sensor slot for proximity switch

| Piston diameter [mm] | Stroke [mm] | With PPV cushioning | | With PPS cushioning | |
|----------------------|-------------|------------------------|------------------------|------------------------|------------------------|
| | | Part no. | Type | Part no. | Type |
| 50 | 20 | 3659467 | DSBC-50-20-D3-PPVA-N3 | 3659491 | DSBC-50-20-D3-PPSA-N3 |
| | 25 | 3659468 | DSBC-50-25-D3-PPVA-N3 | 3659492 | DSBC-50-25-D3-PPSA-N3 |
| | 30 | 3659469 | DSBC-50-30-D3-PPVA-N3 | 3659493 | DSBC-50-30-D3-PPSA-N3 |
| | 40 | 3659470 | DSBC-50-40-D3-PPVA-N3 | 3659494 | DSBC-50-40-D3-PPSA-N3 |
| | 50 | 3659471 | DSBC-50-50-D3-PPVA-N3 | 3659495 | DSBC-50-50-D3-PPSA-N3 |
| | 60 | 3659472 | DSBC-50-60-D3-PPVA-N3 | 3659496 | DSBC-50-60-D3-PPSA-N3 |
| | 70 | 3659473 | DSBC-50-70-D3-PPVA-N3 | 3659497 | DSBC-50-70-D3-PPSA-N3 |
| | 80 | 3659474 | DSBC-50-80-D3-PPVA-N3 | 3659498 | DSBC-50-80-D3-PPSA-N3 |
| | 100 | 3659475 | DSBC-50-100-D3-PPVA-N3 | 3659499 | DSBC-50-100-D3-PPSA-N3 |
| | 125 | 3659476 | DSBC-50-125-D3-PPVA-N3 | 3659500 | DSBC-50-125-D3-PPSA-N3 |
| | 150 | 3659477 | DSBC-50-150-D3-PPVA-N3 | 3659501 | DSBC-50-150-D3-PPSA-N3 |
| | 160 | 3659478 | DSBC-50-160-D3-PPVA-N3 | 3659502 | DSBC-50-160-D3-PPSA-N3 |
| | 200 | 3659479 | DSBC-50-200-D3-PPVA-N3 | 3659503 | DSBC-50-200-D3-PPSA-N3 |
| | 250 | 3659480 | DSBC-50-250-D3-PPVA-N3 | 3659504 | DSBC-50-250-D3-PPSA-N3 |
| 300 | 3659481 | DSBC-50-300-D3-PPVA-N3 | 3659505 | DSBC-50-300-D3-PPSA-N3 | |
| 320 | 3659482 | DSBC-50-320-D3-PPVA-N3 | 3659506 | DSBC-50-320-D3-PPSA-N3 | |
| 63 | 20 | 3657859 | DSBC-63-20-D3-PPVA-N3 | 3657811 | DSBC-63-20-D3-PPSA-N3 |
| | 25 | 3657860 | DSBC-63-25-D3-PPVA-N3 | 3657812 | DSBC-63-25-D3-PPSA-N3 |
| | 30 | 3657861 | DSBC-63-30-D3-PPVA-N3 | 3657813 | DSBC-63-30-D3-PPSA-N3 |
| | 40 | 3657862 | DSBC-63-40-D3-PPVA-N3 | 3657814 | DSBC-63-40-D3-PPSA-N3 |
| | 50 | 3657863 | DSBC-63-50-D3-PPVA-N3 | 3657815 | DSBC-63-50-D3-PPSA-N3 |
| | 60 | 3657864 | DSBC-63-60-D3-PPVA-N3 | 3657816 | DSBC-63-60-D3-PPSA-N3 |
| | 70 | 3657865 | DSBC-63-70-D3-PPVA-N3 | 3657817 | DSBC-63-70-D3-PPSA-N3 |
| | 80 | 3657866 | DSBC-63-80-D3-PPVA-N3 | 3657818 | DSBC-63-80-D3-PPSA-N3 |
| | 100 | 3657867 | DSBC-63-100-D3-PPVA-N3 | 3657819 | DSBC-63-100-D3-PPSA-N3 |
| | 125 | 3657868 | DSBC-63-125-D3-PPVA-N3 | 3657820 | DSBC-63-125-D3-PPSA-N3 |
| | 150 | 3657869 | DSBC-63-150-D3-PPVA-N3 | 3657821 | DSBC-63-150-D3-PPSA-N3 |
| | 160 | 3657870 | DSBC-63-160-D3-PPVA-N3 | 3657822 | DSBC-63-160-D3-PPSA-N3 |
| | 200 | 3657871 | DSBC-63-200-D3-PPVA-N3 | 3657823 | DSBC-63-200-D3-PPSA-N3 |
| | 250 | 3657872 | DSBC-63-250-D3-PPVA-N3 | 3657824 | DSBC-63-250-D3-PPSA-N3 |
| 300 | 3657873 | DSBC-63-300-D3-PPVA-N3 | 3657825 | DSBC-63-300-D3-PPSA-N3 | |
| 320 | 3657874 | DSBC-63-320-D3-PPVA-N3 | 3657826 | DSBC-63-320-D3-PPSA-N3 | |

Data sheet

Ordering data – Versions for DSBC-...D3 (sensor slots on 3 sides)

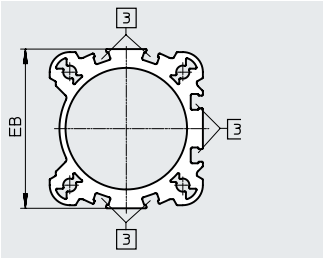

In this version, the piston position can be sensed on 3 sides of the drive.

[3] Sensor slot for proximity switch

| Piston diameter [mm] | Stroke [mm] | With PPV cushioning | | With PPS cushioning | |
|----------------------|-------------|---------------------|------------------------|---------------------|------------------------|
| | | Part no. | Type | Part no. | Type |
| 80 | 20 | 3656631 | DSBC-80-20-D3-PPVA-N3 | 3656854 | DSBC-80-20-D3-PPSA-N3 |
| | 25 | 3656632 | DSBC-80-25-D3-PPVA-N3 | 3656855 | DSBC-80-25-D3-PPSA-N3 |
| | 30 | 3656633 | DSBC-80-30-D3-PPVA-N3 | 3656856 | DSBC-80-30-D3-PPSA-N3 |
| | 40 | 3656634 | DSBC-80-40-D3-PPVA-N3 | 3656857 | DSBC-80-40-D3-PPSA-N3 |
| | 50 | 3656635 | DSBC-80-50-D3-PPVA-N3 | 3656858 | DSBC-80-50-D3-PPSA-N3 |
| | 60 | 3656636 | DSBC-80-60-D3-PPVA-N3 | 3656859 | DSBC-80-60-D3-PPSA-N3 |
| | 70 | 3656637 | DSBC-80-70-D3-PPVA-N3 | 3656860 | DSBC-80-70-D3-PPSA-N3 |
| | 80 | 3656638 | DSBC-80-80-D3-PPVA-N3 | 3656861 | DSBC-80-80-D3-PPSA-N3 |
| | 100 | 3656639 | DSBC-80-100-D3-PPVA-N3 | 3656862 | DSBC-80-100-D3-PPSA-N3 |
| | 125 | 3656640 | DSBC-80-125-D3-PPVA-N3 | 3656863 | DSBC-80-125-D3-PPSA-N3 |
| | 150 | 3656641 | DSBC-80-150-D3-PPVA-N3 | 3656864 | DSBC-80-150-D3-PPSA-N3 |
| | 160 | 3656642 | DSBC-80-160-D3-PPVA-N3 | 3656865 | DSBC-80-160-D3-PPSA-N3 |
| | 200 | 3656643 | DSBC-80-200-D3-PPVA-N3 | 3656866 | DSBC-80-200-D3-PPSA-N3 |
| | 250 | 3656644 | DSBC-80-250-D3-PPVA-N3 | 3656867 | DSBC-80-250-D3-PPSA-N3 |
| | 300 | 3656645 | DSBC-80-300-D3-PPVA-N3 | 3656868 | DSBC-80-300-D3-PPSA-N3 |
| | 320 | 3656646 | DSBC-80-320-D3-PPVA-N3 | 3656869 | DSBC-80-320-D3-PPSA-N3 |

Accessories

Foot mounting HNC/CRHNC

Material:

HNC: Galvanised steel

CRHNC: High-alloy steel

Free of copper and PTFE

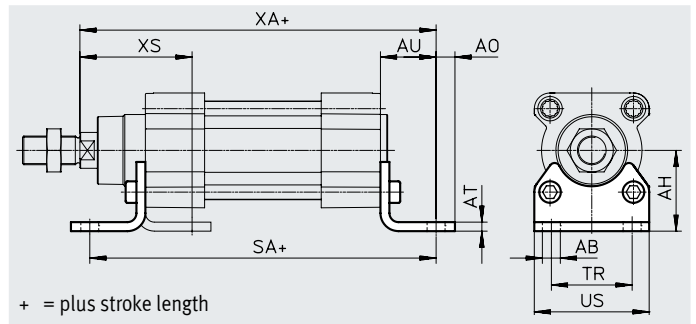

Dimensions and ordering data

| For diam. [mm] | AB ∅ | AH | AO | AT | AU | SA | | TR | US | XA | | XS |
|-------------------|---------|----|------|----|----|---------|-----------|----|-----|---------|-----------|------|
| | | | | | | DSBC... | DSBC...-C | | | DSBC... | DSBC...-C | |
| 32 | 7 | 32 | 6.5 | 4 | 24 | 142 | 187 | 32 | 45 | 143.1 | 188.1 | 46 |
| 40 | 10 | 36 | 9 | 4 | 28 | 161 | 214 | 36 | 54 | 161.9 | 214.9 | 52.7 |
| 50 | 10 | 45 | 9.5 | 5 | 32 | 170 | 237 | 45 | 64 | 173.8 | 240.8 | 62.6 |
| 63 | 10 | 50 | 12.5 | 5 | 32 | 185 | 261 | 50 | 75 | 189.1 | 265.1 | 62.9 |
| 80 | 12 | 63 | 15 | 6 | 41 | 210 | 305 | 63 | 93 | 214.6 | 309.6 | 80.4 |
| 100 | 14.5 | 71 | 17.5 | 6 | 41 | 220 | 318 | 75 | 110 | 228.5 | 326.7 | 84.3 |
| 125 | 16.5 | 90 | 22 | 8 | 45 | 250 | 375 | 90 | 131 | 270 | 394.3 | 102 |

| For diam. [mm] | Basic type | | | | Corrosion-resistant | | | |
|-------------------|-------------------|---------------|----------|--------------------|---------------------|---------------|----------|--------------------|
| | CRC ¹⁾ | Weight [g] | Part no. | Type ²⁾ | CRC ¹⁾ | Weight [g] | Part no. | Type ²⁾ |
| 32 | 2 | 144 | ★ 174369 | HNC-32 | 4 | 139 | 176937 | CRHNC-32 |
| 40 | 2 | 193 | ★ 174370 | HNC-40 | 4 | 188 | 176938 | CRHNC-40 |
| 50 | 2 | 353 | ★ 174371 | HNC-50 | 4 | 341 | 176939 | CRHNC-50 |
| 63 | 2 | 436 | ★ 174372 | HNC-63 | 4 | 424 | 176940 | CRHNC-63 |
| 80 | 2 | 829 | ★ 174373 | HNC-80 | 4 | 809 | 176941 | CRHNC-80 |
| 100 | 2 | 1009 | 174374 | HNC-100 | 4 | 990 | 176942 | CRHNC-100 |
| 125 | 2 | 1902 | 174375 | HNC-125 | 4 | 1920 | 176943 | CRHNC-125 |

1) Corrosion resistance class CRC 2 to Festo standard FN 940070

Moderate corrosion stress. Indoor applications in which condensation can occur. External visible parts with primarily decorative surface requirements which are in direct contact with a normal industrial environment.

Corrosion resistance class CRC 4 to Festo standard FN 940070

Particularly high corrosion stress. Outdoor exposure under extreme corrosive conditions. Parts exposed to aggressive media, e.g. in the chemical or food industries. Such applications may need to be safeguarded by special tests (→ also FN 940082), using appropriate media.

2) Suitable for ATEX

Accessories

Flange mounting FNC/CRFNG

Material:

FNC: Galvanised steel

CRFNG: High-alloy steel

Free of copper and PTFE

RoHS-compliant

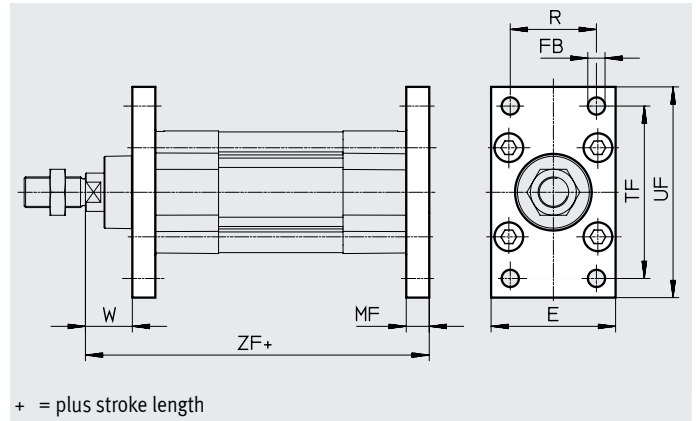

+ = plus stroke length

Dimensions and ordering data

| For diam. [mm] | E | FB ∅ H13 | MF | R | TF | UF | W | ZF | |
|-------------------|-----|----------------|----|----|-----|-----|------|---------|-----------|
| | | | | | | | | DSBC... | DSBC...-C |
| 32 | 45 | 7 | 10 | 32 | 64 | 80 | 16 | 129.1 | 174.1 |
| 40 | 54 | 9 | 10 | 36 | 72 | 90 | 18.7 | 143.9 | 196.9 |
| 50 | 65 | 9 | 12 | 45 | 90 | 110 | 23.6 | 153.8 | 220.8 |
| 63 | 75 | 9 | 12 | 50 | 100 | 120 | 23.9 | 169.1 | 245.1 |
| 80 | 93 | 12 | 16 | 63 | 126 | 150 | 29.4 | 189.6 | 284.6 |
| 100 | 110 | 14 | 16 | 75 | 150 | 175 | 33.3 | 203.5 | 301.7 |
| 125 | 132 | 16 | 20 | 90 | 180 | 210 | 45 | 245 | 369.3 |

| For diam. [mm] | Basic type | | | | Corrosion-resistant | | | |
|-------------------|-------------------|---------------|----------|--------------------|---------------------|---------------|----------|--------------------|
| | CRC ¹⁾ | Weight [g] | Part no. | Type ²⁾ | CRC ¹⁾ | Weight [g] | Part no. | Type ²⁾ |
| 32 | 1 | 221 | ★ 174376 | FNC-32 | 4 | 220 | 161846 | CRFNG-32 |
| 40 | 1 | 291 | ★ 174377 | FNC-40 | 4 | 291 | 161847 | CRFNG-40 |
| 50 | 1 | 536 | ★ 174378 | FNC-50 | 4 | 526 | 161848 | CRFNG-50 |
| 63 | 1 | 679 | ★ 174379 | FNC-63 | 4 | 680 | 161849 | CRFNG-63 |
| 80 | 1 | 1495 | ★ 174380 | FNC-80 | 4 | 1508 | 161850 | CRFNG-80 |
| 100 | 1 | 2041 | 174381 | FNC-100 | 4 | 2054 | 161851 | CRFNG-100 |
| 125 | 1 | 3775 | 174382 | FNC-125 | 4 | 3787 | 185363 | CRFNG-125 |

1) Corrosion resistance class CRC 1 to Festo standard FN 940070

Low corrosion stress. Dry internal application or transport and storage protection. Also applies to parts behind coverings, in the non-visible interior area, and parts which are covered in the application (e.g. drive trunnions).

Corrosion resistance class CRC 4 to Festo standard FN 940070

Particularly high corrosion stress. Outdoor exposure under extreme corrosive conditions. Parts exposed to aggressive media, e.g. in the chemical or food industries. Such applications may need to be safeguarded by special tests (→ also FN 940082), using appropriate media.

1) Suitable for ATEX

Accessories

Trunnion flange ZNCF/CRZNG

Material:

ZNCF: Stainless steel casting

CRZNG: Electropolished stainless steel casting

Free of copper and PTFE

RoHS-compliant

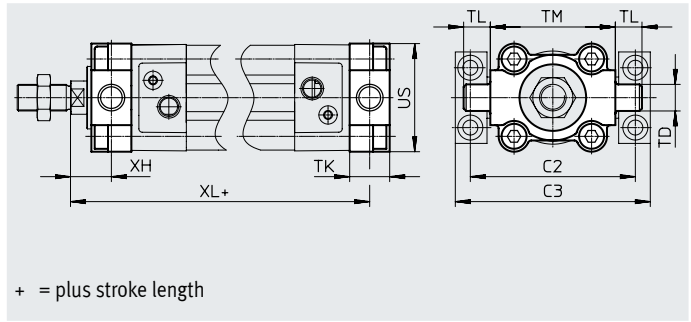

Dimensions and ordering data

| For diam. [mm] | C2 | C3 | TD ø e9 | TK | TL | TM | US | XH | XL | |
|-------------------|-----|-----|---------------|----|----|-----|-----|------|---------|-----------|
| | | | | | | | | | DSBC... | DSBC...-C |
| 32 | 71 | 86 | 12 | 16 | 12 | 50 | 45 | 18 | 127.1 | 172.1 |
| 40 | 87 | 105 | 16 | 20 | 16 | 63 | 54 | 18.7 | 143.9 | 196.9 |
| 50 | 99 | 117 | 16 | 24 | 16 | 75 | 64 | 23.6 | 153.8 | 220.8 |
| 63 | 116 | 136 | 20 | 24 | 20 | 90 | 75 | 23.9 | 169.1 | 245.1 |
| 80 | 136 | 156 | 20 | 28 | 20 | 110 | 93 | 31.4 | 187.6 | 282.6 |
| 100 | 164 | 189 | 25 | 38 | 25 | 132 | 110 | 30.3 | 206.5 | 304.7 |
| 125 | 192 | 217 | 25 | 50 | 25 | 160 | 131 | 40 | 250 | 374.3 |

| For diam. [mm] | Basic type | | | | Corrosion-resistant | | | |
|-------------------|-------------------|---------------|----------|--------------------|---------------------|---------------|----------|--------------------|
| | CRC ¹⁾ | Weight [g] | Part no. | Type ²⁾ | CRC ¹⁾ | Weight [g] | Part no. | Type ²⁾ |
| 32 | 2 | 150 | 174411 | ZNCF-32 | 4 | 150 | 161852 | CRZNG-32 |
| 40 | 2 | 285 | 174412 | ZNCF-40 | 4 | 285 | 161853 | CRZNG-40 |
| 50 | 2 | 473 | 174413 | ZNCF-50 | 4 | 473 | 161854 | CRZNG-50 |
| 63 | 2 | 687 | 174414 | ZNCF-63 | 4 | 687 | 161855 | CRZNG-63 |
| 80 | 2 | 1296 | 174415 | ZNCF-80 | 4 | 1296 | 161856 | CRZNG-80 |
| 100 | 2 | 2254 | 174416 | ZNCF-100 | 4 | 2254 | 161857 | CRZNG-100 |
| 125 | 2 | 3484 | 174417 | ZNCF-125 | 4 | 3484 | 185362 | CRZNG-125 |

1) Corrosion resistance class CRC 2 to Festo standard FN 940070

Moderate corrosion stress. Indoor applications in which condensation can occur. External visible parts with primarily decorative surface requirements which are in direct contact with a normal industrial environment.

Corrosion resistance class CRC 4 to Festo standard FN 940070

Particularly high corrosion stress. Outdoor exposure under extreme corrosive conditions. Parts exposed to aggressive media, e.g. in the chemical or food industries. Such applications may need to be safeguarded by special tests (→ also FN 940082), using appropriate media.

1) Suitable for ATEX

Accessories

Trunnion support LNZG

Material:
 Trunnion support: Anodised aluminium
 Plain bearing: Plastic
 Free of copper and PTFE
 RoHS-compliant

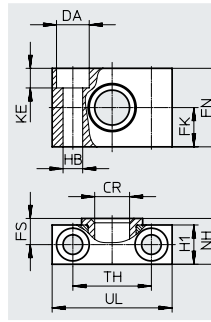

| Dimensions and ordering data | | | | | | | | | | | | | | Weight | Part no. | Type |
|------------------------------|----------|----------|-----------|----|------|------|----------|-----|------|------|----|-------------------|-----|--------|--------------|------|
| For diam. | CR | DA | FK | FN | FS | H1 | HB | KE | NH | TH | UL | CRC ¹⁾ | | | | |
| [mm] | ∅ D11 | ∅ H13 | ∅ ±0.1 | | | | ∅ H13 | | | ±0.2 | | | [g] | | | |
| 32 | 12 | 11 | 15 | 30 | 10.5 | 15 | 6.6 | 6.8 | 18 | 32 | 46 | 2 | 90 | 32959 | LNZG-32 | |
| 40, 50 | 16 | 15 | 18 | 36 | 12 | 18 | 9 | 9 | 21 | 36 | 55 | 2 | 140 | 32960 | LNZG-40/50 | |
| 63, 80 | 20 | 18 | 20 | 40 | 13 | 20 | 11 | 11 | 23 | 42 | 65 | 2 | 190 | 32961 | LNZG-63/80 | |
| 100, 125 | 25 | 20 | 25 | 50 | 16 | 24.5 | 14 | 13 | 28.5 | 50 | 75 | 2 | 320 | 32962 | LNZG-100/125 | |

1) Corrosion resistance class CRC 2 to Festo standard FN 940070
 Moderate corrosion stress. Indoor applications in which condensation can occur. External visible parts with primarily decorative surface requirements which are in direct contact with a normal industrial environment.

Trunnion support CRLNZG

Material:
 High-alloy steel
 Free of copper and PTFE
 RoHS-compliant

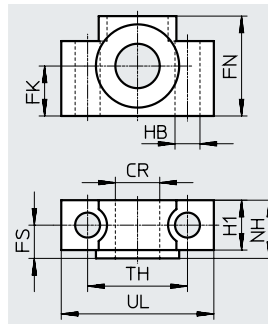
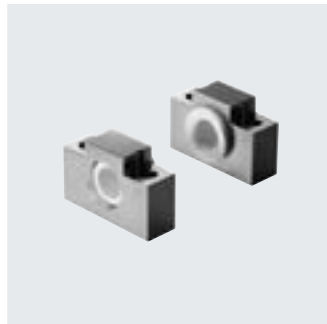

| Dimensions and ordering data | | | | | | | | | | | | Weight | Part no. | Type | |
|------------------------------|----------|-----------|----|------|------|----------|------|------|----|-------------------|--|--------|----------|----------------|--|
| For diam. | CR | FK | FN | FS | H1 | HB | NH | TH | UL | CRC ¹⁾ | | | | | |
| [mm] | ∅ D11 | ∅ ±0.1 | | | | ∅ H13 | | ±0.2 | | | | [g] | | | |
| 32 | 12 | 15 | 30 | 10.5 | 15 | 6.6 | 18 | 32 | 46 | 4 | | 205 | 161874 | CRLNZG-32 | |
| 40, 50 | 16 | 18 | 36 | 12 | 18 | 9 | 21 | 36 | 55 | 4 | | 323 | 161875 | CRLNZG-40/50 | |
| 63, 80 | 20 | 20 | 40 | 13 | 20 | 11 | 23 | 42 | 65 | 4 | | 435 | 161876 | CRLNZG-63/80 | |
| 100, 125 | 25 | 25 | 50 | 16 | 24.5 | 14 | 28.5 | 50 | 75 | 4 | | 739 | 161877 | CRLNZG-100/125 | |

1) Corrosion resistance class CRC 4 to Festo standard FN 940070
 Particularly high corrosion stress. Outdoor exposure under extreme corrosive conditions. Parts exposed to aggressive media, e.g. in the chemical or food industries. Such applications may need to be safeguarded by special tests (→ also FN 940082), using appropriate media.

Accessories

Swivel flange SNC

Material:
Die-cast aluminium
Free of copper and PTFE
RoHS-compliant

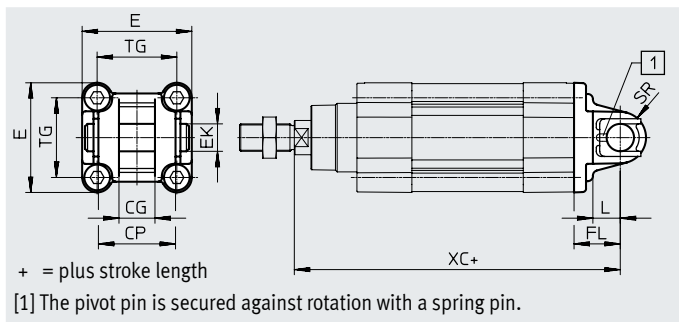

Dimensions and ordering data

| For diam. | CG | CP | E | EK ∅ | FL | L | SR |
|-----------|-----|-----|--------------------------|---------|------|----|----|
| [mm] | H14 | h14 | | H9 | ±0.2 | | |
| 32 | 14 | 34 | 45 ^{+0.2/-0.5} | 10 | 22 | 13 | 10 |
| 40 | 16 | 40 | 54 ^{-0.5} | 12 | 25 | 16 | 12 |
| 50 | 21 | 45 | 64 ^{-0.6} | 16 | 27 | 16 | 12 |
| 63 | 21 | 51 | 75 ^{-0.6} | 16 | 32 | 21 | 16 |
| 80 | 25 | 65 | 93 ^{-0.8} | 20 | 36 | 22 | 16 |
| 100 | 25 | 75 | 110 ^{+0.3/-0.8} | 20 | 41 | 27 | 20 |
| 125 | 37 | 97 | 131 ^{-0.8} | 30 | 50 | 30 | 25 |

| For diam. | TG | XC | | CRC ¹⁾ | Weight [g] | Part no. | Type ²⁾ |
|-----------|------|---------|-----------|-------------------|---------------|----------|--------------------|
| | | DSBC... | DSBC...-C | | | | |
| 32 | 32.5 | 141.1 | 186.1 | 1 | 93 | ★ 174383 | SNC-32 |
| 40 | 38 | 158.9 | 211.9 | 1 | 140 | ★ 174384 | SNC-40 |
| 50 | 46.5 | 168.8 | 235.8 | 1 | 234 | ★ 174385 | SNC-50 |
| 63 | 56.5 | 189.1 | 265.1 | 1 | 331 | ★ 174386 | SNC-63 |
| 80 | 72 | 209.6 | 304.6 | 1 | 618 | ★ 174387 | SNC-80 |
| 100 | 89 | 228.5 | 326.7 | 1 | 865 | ★ 174388 | SNC-100 |
| 125 | 110 | 275 | 399.3 | 1 | 1728 | ★ 174389 | SNC-125 |

- 1) Corrosion resistance class CRC 1 to Festo standard FN 940070
Low corrosion stress. Dry internal application or transport and storage protection. Also applies to parts behind coverings, in the non-visible interior area, and parts which are covered in the application (e.g. drive trunnions).
- 2) Suitable for ATEX

Accessories

Swivel flange SNCB/SNCB-...-R3

Material:

SNCB: Die-cast aluminium

SNCB-...-R3: die-cast aluminium with protective coating

Free of copper and PTFE

RoHS-compliant

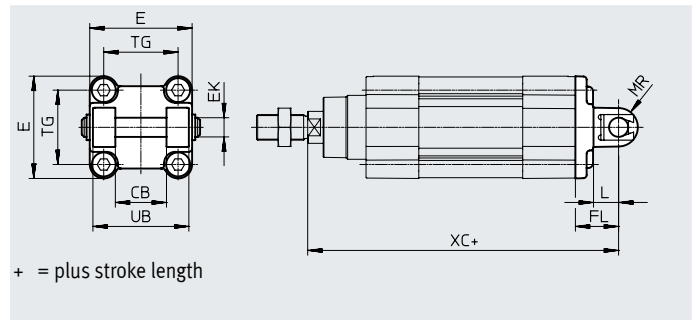

Dimensions and ordering data

| For diam. [mm] | CB H14 | E 45+0.2/-0.5 | EK ∅ H9/e8 | FL ±0.2 | L | MR -0.5 | TG | UB h14 | XC | |
|-------------------|-----------|---------------------|------------------|------------|----|------------|------|-----------|---------|-----------|
| | | | | | | | | | DSBC... | DSBC... C |
| 32 | 26 | 45+0.2/-0.5 | 10 | 22 | 13 | 8.5 | 32.5 | 45 | 141.1 | 186.1 |
| 40 | 28 | 54 _{-0.5} | 12 | 25 | 16 | 12 | 38 | 52 | 158.9 | 211.9 |
| 50 | 32 | 64 _{-0.6} | 12 | 27 | 16 | 12 | 46.5 | 60 | 168.8 | 235.8 |
| 63 | 40 | 75 _{-0.6} | 16 | 32 | 21 | 16 | 56.5 | 70 | 189.1 | 265.1 |
| 80 | 50 | 93 _{-0.8} | 16 | 36 | 22 | 16 | 72 | 90 | 209.6 | 304.6 |
| 100 | 60 | 110+0.3/-0.8 | 20 | 41 | 27 | 20 | 89 | 110 | 228.5 | 326.7 |
| 125 | 70 | 131 _{-0.8} | 25 | 50 | 30 | 25 | 110 | 130 | 275 | 399.3 |

| For diam. [mm] | Basic type | | | | R3 – High corrosion protection | | | |
|-------------------|-------------------|---------------|----------|----------|--------------------------------|---------------|----------|-------------|
| | CRC ¹⁾ | Weight [g] | Part no. | Type | CRC ¹⁾ | Weight [g] | Part no. | Type |
| 32 | 1 | 103 | ★ 174390 | SNCB-32 | 3 | 100 | 176944 | SNCB-32-R3 |
| 40 | 1 | 155 | ★ 174391 | SNCB-40 | 3 | 151 | 176945 | SNCB-40-R3 |
| 50 | 1 | 232 | ★ 174392 | SNCB-50 | 3 | 228 | 176946 | SNCB-50-R3 |
| 63 | 1 | 375 | ★ 174393 | SNCB-63 | 3 | 371 | 176947 | SNCB-63-R3 |
| 80 | 1 | 636 | ★ 174394 | SNCB-80 | 3 | 632 | 176948 | SNCB-80-R3 |
| 100 | 1 | 1035 | 174395 | SNCB-100 | 3 | 986 | 176949 | SNCB-100-R3 |
| 125 | 1 | 1860 | 174396 | SNCB-125 | 3 | 1776 | 176950 | SNCB-125-R3 |

1) Corrosion resistance class CRC 1 to Festo standard FN 940070

Low corrosion stress. Dry internal application or transport and storage protection. Also applies to parts behind coverings, in the non-visible interior area, and parts which are covered in the application (e.g. drive trunnions).

Corrosion resistance class CRC 3 to Festo standard FN 940070

High corrosion stress. Outdoor exposure under moderate corrosive conditions. Externally visible parts with primarily functional surface requirements which are in direct contact with a normal industrial environment.

Accessories

Swivel flange

SNCS/CRSNCS/SNCS-...-R3

Material:

SNCS 32 ... 50: Die-cast aluminium

SNCS 63 ... 125:

Wrought aluminium alloy

CRSNCS 32 ... 80:

High-alloy stainless steel

SNCS-...-R3 100 ... 125:

Wrought aluminium alloy with

protective coating

RoHS-compliant

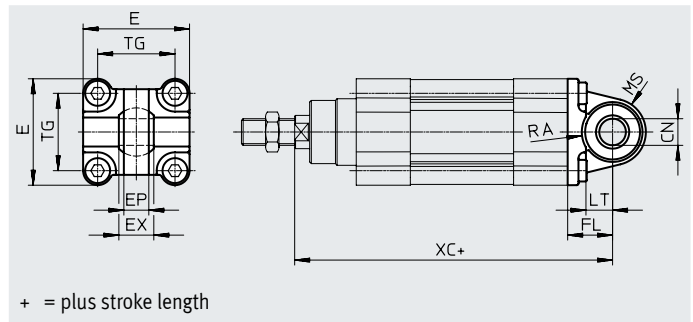

Dimensions and ordering data

| For diam. [mm] | CN ∅ | | E | | EP ±0.2 | EX | FL ±0.2 | LT |
|-------------------|----------------------|----------------------------|-------------------------|------------------------|------------|----|------------|----|
| | DSBC... | DSBC...-R3 | DSBC... | DSBC...-R3 | | | | |
| 32 | 10 ^{+0.013} | 10 ^{+0.015/-0.04} | 45 ^{+0.2/-0.5} | 45 ^{-0.5} | 10.5 | 14 | 22 | 13 |
| 40 | 12 ^{+0.015} | 12 ^{+0.018/-0.04} | 54 ^{-0.5} | 54 ^{-0.5} | 12 | 16 | 25 | 16 |
| 50 | 16 ^{+0.015} | 16 ^{+0.018/-0.04} | 64 ^{-0.6} | 64 ^{-0.6} | 15 | 21 | 27 | 16 |
| 63 | 16 ^{+0.015} | 16 ^{+0.018/-0.04} | 74.5 ^{+0.5} | 75 ^{-0.6} | 15 | 21 | 32 | 21 |
| 80 | 20 ^{+0.018} | 20 ^{+0.021/-0.04} | 92.2 ^{+0.8} | 93 ^{-0.8} | 18 | 25 | 36 | 22 |
| 100 | 20 ^{+0.018} | 20 ^{+0.021/-0.04} | 109 ^{+1/-0.7} | 109 ^{+1/-0.7} | 18 | 25 | 41 | 27 |
| 125 | 30 ^{+0.018} | 30 ^{+0.021/-0.04} | 132 ^{+1/-0.7} | 132 ^{+1/-0.7} | 25 | 37 | 50 | 30 |

| For diam. [mm] | MS | | RA | | TG | XC | |
|-------------------|--------------------|--------------------|---------------|------------------|------|---------|-----------|
| | DSBC... | DSBC...-R3 | DSBC... +1 | DSBC...-R3 +1 | | DSBC... | DSBC...-C |
| 32 | 15 ^{+0.5} | 15 ^{+0.5} | 14.5 | 14.5 | 32.5 | 141.1 | 186.1 |
| 40 | 17 ^{+0.5} | 17 ^{+0.5} | 17.5 | 17.5 | 38 | 158.9 | 211.9 |
| 50 | 20 ^{+0.5} | 20 ^{+0.5} | 18.5 | 19 | 46.5 | 168.8 | 235.8 |
| 63 | 23 ^{-0.5} | 22 ^{+0.5} | 23 | 23 | 56.5 | 189.1 | 265.1 |
| 80 | 28 ^{-0.5} | 27 ^{+0.5} | 25 | 25 | 72 | 209.6 | 304.6 |
| 100 | 30 ^{+0.5} | 30 ^{+0.5} | 95 | 100 | 89 | 228.5 | 326.7 |
| 125 | 39 ^{+0.5} | 39 ^{+0.5} | 100 | 100 | 110 | 275 | 326.7 |

| For diam. [mm] | Basic type | | | | High corrosion protection | | | |
|-------------------|-------------------|---------------|----------|----------|---------------------------|---------------|----------|-------------|
| | CRC ¹⁾ | Weight [g] | Part no. | Type | CRC ¹⁾ | Weight [g] | Part no. | Type |
| 32 | 1 | 86 | ★ 174397 | SNCS-32 | 4 | 161 | 2895920 | CRSNCS-32 |
| 40 | 1 | 122 | ★ 174398 | SNCS-40 | 4 | 239 | 2895921 | CRSNCS-40 |
| 50 | 1 | 216 | ★ 174399 | SNCS-50 | 4 | 403 | 2895922 | CRSNCS-50 |
| 63 | 2 | 281 | ★ 174400 | SNCS-63 | 4 | 576 | 2895923 | CRSNCS-63 |
| 80 | 2 | 557 | ★ 174401 | SNCS-80 | 4 | 1173 | 2895924 | CRSNCS-80 |
| 100 | 2 | 683 | 174402 | SNCS-100 | 3 | 684 | 2895925 | SNCS-100-R3 |
| 125 | 2 | 1369 | 174403 | SNCS-125 | 3 | 1369 | 2895926 | SNCS-125-R3 |

1) Corrosion resistance class CRC 1 to Festo standard FN 940070

Low corrosion stress. Dry internal application or transport and storage protection. Also applies to parts behind coverings, in the non-visible interior area, and parts which are covered in the application (e.g. drive trunnions).

Corrosion resistance class CRC 2 to Festo standard FN 940070

Moderate corrosion stress. Indoor applications in which condensation can occur. External visible parts with primarily decorative surface requirements which are in direct contact with a normal industrial environment.

Corrosion resistance class CRC 3 to Festo standard FN 940070

High corrosion stress. Outdoor exposure under moderate corrosive conditions. Externally visible parts with primarily functional surface requirements which are in direct contact with a normal industrial environment.

Corrosion resistance class CRC 4 to Festo standard FN 940070

Particularly high corrosion stress. Outdoor exposure under extreme corrosive conditions. Parts exposed to aggressive media, e.g. in the chemical or food industries. Such applications may need to be safeguarded by special tests

(→ also FN 940082), using appropriate media.

Accessories

Swivel flange SNCL

Material:
Die-cast aluminium
Free of copper and PTFE
RoHS-compliant

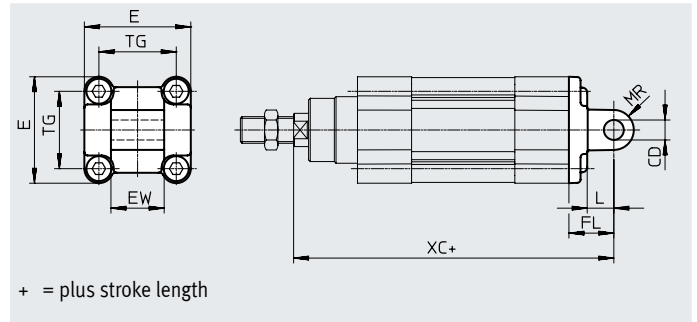

Dimensions and ordering data

| For diam. [mm] | CD ∅ H9 | E | EW h12 | FL ±0.2 | L | MR |
|-------------------|---------------|--------------------------|-----------|------------|----|----|
| 32 | 10 | 45 ^{+0.2/-0.5} | 26 | 22 | 13 | 10 |
| 40 | 12 | 54 ^{-0.5} | 28 | 25 | 16 | 12 |
| 50 | 12 | 64 ^{-0.6} | 32 | 27 | 16 | 12 |
| 63 | 16 | 75 ^{-0.6} | 40 | 32 | 21 | 16 |
| 80 | 16 | 93 ^{-0.8} | 50 | 36 | 22 | 16 |
| 100 | 20 | 110 ^{+0.3/-0.8} | 60 | 41 | 27 | 20 |
| 125 | 25 | 131 ^{-0.8} | 70 | 50 | 30 | 25 |

| For diam. [mm] | TG | XC | | CRC ¹⁾ | Weight [g] | Part no. | Type |
|-------------------|------|---------|------------|-------------------|---------------|----------|----------|
| | | DSBC... | DSBC....-C | | | | |
| 32 | 32.5 | 141.1 | 186.1 | 1 | 71 | ★ 174404 | SNCL-32 |
| 40 | 38 | 158.9 | 211.9 | 1 | 95 | ★ 174405 | SNCL-40 |
| 50 | 46.5 | 168.8 | 235.8 | 1 | 158 | ★ 174406 | SNCL-50 |
| 63 | 56.5 | 189.1 | 265.1 | 1 | 225 | ★ 174407 | SNCL-63 |
| 80 | 72 | 209.6 | 304.6 | 1 | 436 | ★ 174408 | SNCL-80 |
| 100 | 89 | 228.5 | 326.7 | 1 | 606 | 174409 | SNCL-100 |
| 125 | 110 | 275 | 399.3 | 1 | 1135 | 174410 | SNCL-125 |

1) Corrosion resistance class CRC 1 to Festo standard FN 940070

Low corrosion stress. Dry internal application or transport and storage protection. Also applies to parts behind coverings, in the non-visible interior area, and parts which are covered in the application (e.g. drive trunnions).

Accessories

Trunnion flange kit DAMT

The kit can be attached at any position along the profile barrel of the cylinder.

Material:
Galvanised steel
RoHS-compliant

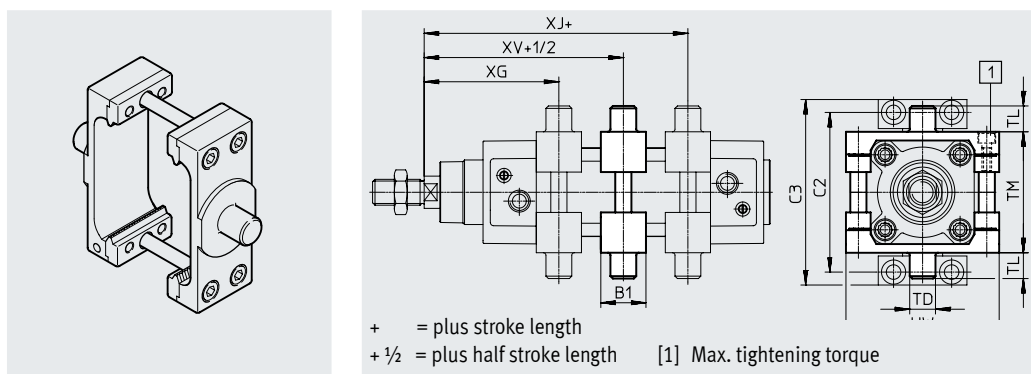

Dimensions and ordering data

| For diam. | B1 | C2 | C3 | TD ∅ e9 | TL | TM | UW |
|-----------|----|-----|-----|---------------|----|-----|-----|
| [mm] | | | | | | | |
| 32 | 30 | 71 | 86 | 12 | 12 | 50 | 65 |
| 40 | 32 | 87 | 105 | 16 | 16 | 63 | 75 |
| 50 | 34 | 99 | 117 | 16 | 16 | 75 | 95 |
| 63 | 41 | 116 | 136 | 20 | 20 | 90 | 105 |
| 80 | 44 | 136 | 156 | 20 | 20 | 110 | 130 |
| 100 | 48 | 164 | 189 | 25 | 25 | 132 | 145 |
| 125 | 50 | 192 | 217 | 25 | 25 | 160 | 177 |

| For diam. | XG | XJ | XV | Max. tightening torque [Nm] | CRC ¹⁾ | Weight [g] | Part no. | Type ²⁾ |
|-----------|-----------|-----------|-----------|-----------------------------------|-------------------|---------------|-----------|--------------------|
| [mm] | min. | max. | | | | | | |
| 32 | 69±1.4 | 76±1.4 | 73±1.4 | 4+1 | 1 | 213 | ★ 2213233 | DAMT-V1-32-A |
| 40 | 77.7±1.4 | 84.9±1.4 | 81.2±1.4 | 8+1 | 1 | 388 | ★ 2214899 | DAMT-V1-40-A |
| 50 | 85.6±1.4 | 91.8±1.4 | 88.6±1.4 | 8+2 | 1 | 608 | ★ 2214909 | DAMT-V1-50-A |
| 63 | 96.9±1.8 | 96.1±1.8 | 96.4±1.8 | 18+2 | 1 | 911 | ★ 2214971 | DAMT-V1-63-A |
| 80 | 110.4±1.8 | 108.6±1.8 | 109.4±1.8 | 28+2 | 1 | 1494 | ★ 163529 | DAMT-V1-80-A |
| 100 | 121.3±1.8 | 115.5±1.8 | 118.3±1.8 | 28+2 | 1 | 2095 | 163530 | DAMT-V1-100-A |
| 125 | 134.7±1.8 | 155.3±1.8 | 145±1.8 | 40+2 | 1 | 3548 | 1812524 | DAMT-V8-125-A |



1) Corrosion resistance class CRC 1 to Festo standard FN 940070

Low corrosion stress. Dry internal application or transport and storage protection. Also applies to parts behind coverings, in the non-visible interior area, and parts which are covered in the application (e.g. drive trunnions).

2) Suitable for ATEX

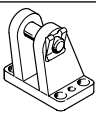

Accessories

Ordering data – Mounting components

| Designation | For diam. | Part no. | Type |
|---|-----------|----------|----------|
| Clevis foot LNG | | | |
|  | 32 | ★ 33890 | LNG-32 |
| | 40 | ★ 33891 | LNG-40 |
| | 50 | ★ 33892 | LNG-50 |
| | 63 | ★ 33893 | LNG-63 |
| | 80 | ★ 33894 | LNG-80 |
| | 100 | 33895 | LNG-100 |
| | 125 | 33896 | LNG-125 |
| Clevis foot LSNG | | | |
|  | 32 | 31740 | LSNG-32 |
| | 40 | 31741 | LSNG-40 |
| | 50 | 31742 | LSNG-50 |
| | 63 | 31743 | LSNG-63 |
| | 80 | 31744 | LSNG-80 |
| | 100 | 31745 | LSNG-100 |
| | 125 | 31746 | LSNG-125 |
| Clevis foot LBG¹⁾ | | | |
|  | 32 | 31761 | LBG-32 |
| | 40 | 31762 | LBG-40 |
| | 50 | 31763 | LBG-50 |
| | 63 | 31764 | LBG-63 |
| | 80 | 31765 | LBG-80 |
| | 100 | 31766 | LBG-100 |
| | 125 | 31767 | LBG-125 |

1) Suitable for ATEX

Ordering data – Mounting components

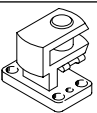
| Designation | For diam. | Part no. | Type |
|---|-----------|----------|-----------|
| Clevis foot LSN | | | |
|  | 32 | 5561 | LSN-32 |
| | 40 | 5562 | LSN-40 |
| | 50 | 5563 | LSN-50 |
| | 63 | 5564 | LSN-63 |
| | 80 | 5565 | LSN-80 |
| | 100 | 5566 | LSN-100 |
| | 125 | 6987 | LSN-125 |
| Clevis foot LSNSG | | | |
|  | 32 | 31747 | LSNSG-32 |
| | 40 | 31748 | LSNSG-40 |
| | 50 | 31749 | LSNSG-50 |
| | 63 | 31750 | LSNSG-63 |
| | 80 | 31751 | LSNSG-80 |
| | 100 | 31752 | LSNSG-100 |
| | 125 | 31753 | LSNSG-125 |
| Right-angle clevis foot LQG¹⁾ | | | |
|  | 32 | 31768 | LQG-32 |
| | 40 | 31769 | LQG-40 |
| | 50 | 31770 | LQG-50 |
| | 63 | 31771 | LQG-63 |
| | 80 | 31772 | LQG-80 |
| | 100 | 31773 | LQG-100 |
| | 125 | 31774 | LQG-125 |

Ordering data – Mounting components, corrosion-resistant

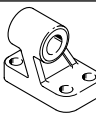
| Designation | For diam. | Part no. | Type |
|---|-----------|----------|-----------|
| Clevis foot CRLNG | | | |
|  | 32 | 161840 | CRLNG-32 |
| | 40 | 161841 | CRLNG-40 |
| | 50 | 161842 | CRLNG-50 |
| | 63 | 161843 | CRLNG-63 |
| | 80 | 161844 | CRLNG-80 |
| | 100 | 161845 | CRLNG-100 |
| | 125 | 176951 | CRLNG-125 |

Ordering data – Mounting components, high corrosion protection

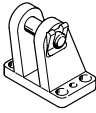
| Designation | For diam. | Part no. | Type |
|---|-----------|----------|------------|
| Clevis foot LBG-R3 | | | |
|  | 32 | 2078790 | LBG-32-R3 |
| | 40 | 2078792 | LBG-40-R3 |
| | 50 | 2078794 | LBG-50-R3 |
| | 63 | 2078795 | LBG-63-R3 |
| | 80 | 2078797 | LBG-80-R3 |
| | 100 | 2078799 | LBG-100-R3 |
| | 125 | 2078837 | LBG-125-R3 |

Accessories

Ordering data – Piston rod attachments

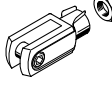
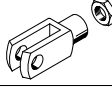
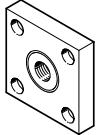
| Designation | For diam. | Part no. | Type |
|--|-----------|----------|--------------|
| Rod eye SGS | | | |
|  | 32 | ★ 9261 | SGS-M10x1.25 |
| | 40 | ★ 9262 | SGS-M12x1.25 |
| | 50 | ★ 9263 | SGS-M16x1.5 |
| | 63 | | |
| | 80 | ★ 9264 | SGS-M20x1.5 |
| | 100 | | |
| | 125 | 10774 | SGS-M27x2 |
| Rod clevis SG¹⁾ | | | |
|  | 32 | ★ 6144 | SG-M10x1.25 |
| | 40 | ★ 6145 | SG-M12x1.25 |
| | 50 | ★ 6146 | SG-M16x1.5 |
| | 63 | | |
|  | 80 | ★ 6147 | SG-M20x1.5 |
| | 100 | | |
| | 125 | 14987 | SG-M27x2-B |
| Coupling piece KSG¹⁾ | | | |
|  | 32 | 32963 | KSG-M10x1.25 |
| | 40 | 32964 | KSG-M12x1.25 |
| | 50 | 32965 | KSG-M16x1.5 |
| | 63 | | |
| | 80 | 32966 | KSG-M20x1.5 |
| | 100 | | |
| | 125 | 32967 | KSG-M27x2 |

1) Suitable for ATEX

Data sheets → Internet: piston rod attachment

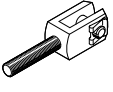
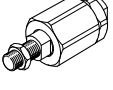
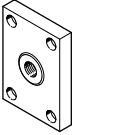
| Designation | For diam. | Part no. | Type |
|---|-----------|----------|--------------|
| Rod clevis SGA¹⁾ | | | |
|  | 32 | 32954 | SGA-M10x1.25 |
| | 40 | 10767 | SGA-M12x1.25 |
| | 50 | 10768 | SGA-M16x1.5 |
| | 63 | | |
| | 80 | 10769 | SGA-M20x1.5 |
| | 100 | | |
| | 125 | 10770 | SGA-M27x2 |
| Self-aligning rod coupler FK¹⁾ | | | |
|  | 32 | ★ 6140 | FK-M10x1.25 |
| | 40 | ★ 6141 | FK-M12x1.25 |
| | 50 | ★ 6142 | FK-M16x1.5 |
| | 63 | | |
| | 80 | ★ 6143 | FK-M20x1.5 |
| | 100 | | |
| | 125 | 10485 | FK-M27x2 |
| Coupling piece KSZ¹⁾ | | | |
|  | 32 | 36125 | KSZ-M10x1.25 |
| | 40 | 36126 | KSZ-M12x1.25 |
| | 50 | 36127 | KSZ-M16x1.5 |
| | 63 | | |
| | 80 | 36128 | KSZ-M20x1.5 |
| | 100 | | |
| | 125 | - | - |

Ordering data – Piston rod attachments, corrosion-resistant

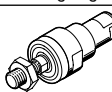
| Designation | For diam. | Part no. | Type |
|--|-----------|----------|----------------|
| Rod eye CRSGS | | | |
|  | 32 | 195582 | CRSGS-M10x1.25 |
| | 40 | 195583 | CRSGS-M12x1.25 |
| | 50 | 195584 | CRSGS-M16x1.5 |
| | 63 | | |
| | 80 | 195585 | CRSGS-M20x1.5 |
| | 100 | | |
| | 125 | 195586 | CRSGS-M27x2 |
| Self-aligning rod coupler CRFK¹⁾ | | | |
|  | 32 | 2305778 | CRFK-M10x1.25 |
| | 40 | 2305779 | CRFK-M12x1.25 |
| | 50 | 2490673 | CRFK-M16x1.5 |
| | 63 | | |
| | 80 | 2545677 | CRFK-M20x1.5 |
| | 100 | | |

1) Suitable for ATEX

Data sheets → Internet: piston rod attachment

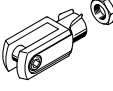
| Designation | For diam. | Part no. | Type |
|---|-----------|----------|---------------|
| Rod clevis CRSG¹⁾ | | | |
|  | 32 | 13569 | CRSG-M10x1.25 |
| | 40 | 13570 | CRSG-M12x1.25 |
| | 50 | 13571 | CRSG-M16x1.5 |
| | 63 | | |
| | 80 | 13572 | CRSG-M20x1.5 |
| | 100 | | |
| | 125 | 185361 | CRSG-M27x2 |

Accessories

Bellows kit DADB



General technical data

| Type DADB-V6- | | 32 | 40 | 50 | 63 | 80 | 100 |
|---|------|---|------------|------------|------------|------------|------------|
| Max. stroke range of the cylinder ¹⁾ | [mm] | 10 ... 500 | 10 ... 500 | 10 ... 500 | 10 ... 500 | 10 ... 500 | 10 ... 500 |
| Type of mounting | | Via threaded pin | | | | | |
| Mounting position | | Any | | | | | |
| Media resistance | | Dust, chippings, oil, grease, fuel (→ Internet: media resistance) | | | | | |
| Ambient temperature ²⁾ | [°C] | -10 ... +80 | | | | | |
| Degree of protection | | IP54 | | | | | |
| Corrosion resistance CRC ³⁾ | | 3 | | | | | |

1) In combination with the bellows kit DADB

2) Note operating range of proximity switches and cylinder

3) Corrosion resistance class CRC 3 to Festo standard FN 940070

High corrosion stress. Outdoor exposure under moderate corrosive conditions. Externally visible parts with primarily functional surface requirements which are in direct contact with a normal industrial environment.

Materials

Sectional view

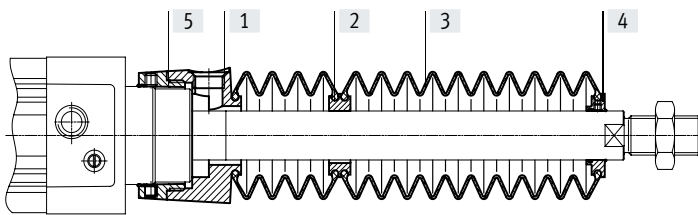

Bellows

| [1] | Connection | Polyamide |
|-----|-------------------|---|
| [2] | Adapter | Polyamide |
| [3] | Bellows | NBR |
| [4] | End piece | Polyamide |
| [5] | Connector | Polyamide |
| - | O-ring | NBR |
| | Note on materials | Free of copper and PTFE RoHS-compliant |

Weight [g]

| Type DADB-V6- Stroke [mm] | 32 | 40 | 50 | 63 | 80 | 100 |
|------------------------------|-----|-----|-----|-----|-----|-----|
| 10 ... 50 | 29 | 42 | 71 | 69 | 99 | 124 |
| 51 ... 125 | 41 | 56 | 91 | 89 | 127 | 152 |
| 126 ... 175 | 52 | 68 | 105 | 103 | 140 | 165 |
| 176 ... 250 | 66 | 85 | 129 | 127 | 193 | 218 |
| 251 ... 300 | 79 | 100 | 147 | 145 | 231 | 255 |
| 301 ... 350 | 92 | 115 | 166 | 164 | 268 | 293 |
| 351 ... 375 | 92 | 115 | 167 | 165 | 259 | 284 |
| 376 ... 425 | 104 | 129 | 185 | 183 | 296 | 321 |
| 426 ... 475 | 117 | 144 | 204 | 202 | 334 | 359 |
| 476 ... 500 | 117 | 144 | 205 | 203 | 324 | 349 |

Accessories

Travel speed v as a function of tubing length l

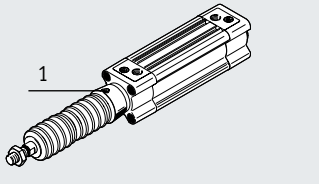

The bellows kit is a leak-free system. To prevent unwanted media from being drawn in, the supply and exhaust air must be ducted via a pressure

compensation hole in the connection part [1]. The pressure generated in the bellows kit by the positioning motion is primarily defined by the travel speed and the

tubing length. The recommended tubing length based on the travel speed of the drive can be read from the graph.

Advancing

Retracting

DADB-32 ... 100

DADB-32 ... 100

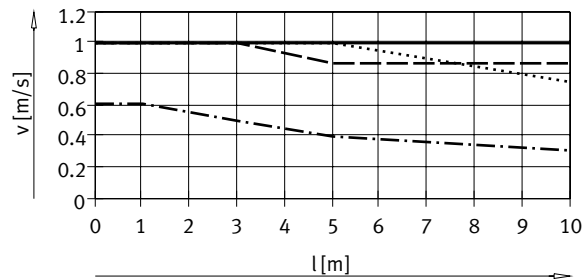
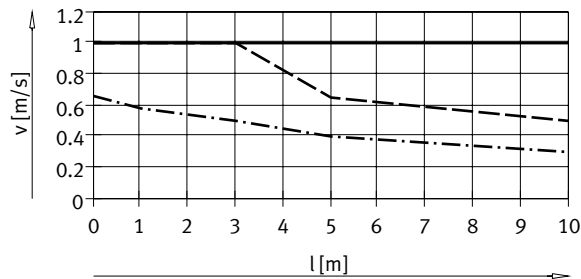

— ø 32/ 50/63
 ø 40
 - - - ø 80/100

— ø 32
 ø 40
 - - - ø 50/63
 ø 80/100

Note

The push-in fittings in the adjacent table must be used for the pressure compensation hole. Silencers can be used as an alternative. This reduces the travel speed slightly.

Tube size and push-in fitting for pressure compensation hole

| ø [mm] | Tubing O.D. [mm] | Push-in fitting | |
|-----------------|------------------|-----------------|--------------------|
| | | Part no. | Type |
| 32, 40 | 8 | ★ 186109 | QS-G1/8-8-I |
| | | 578376 | NPQH-DK-G18-Q8-P10 |
| | | 578362 | NPQH-D-G18-S8-P10 |
| 50, 63, 80, 100 | 12 | ★ 186350 | QS-G1/4-12 |
| | | 578344 | NPQH-D-G14-Q12-P10 |
| | | 578366 | NPQH-D-G14-S12-P10 |

Accessories

Dimensions

Download CAD data → www.festo.com

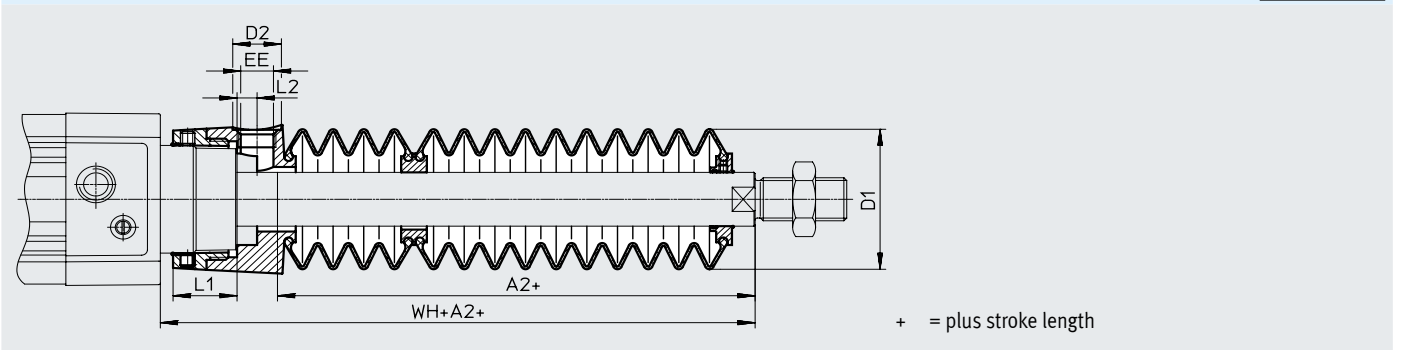

| ∅ Stroke [mm] | 32 | | | | | | | 40 | | | | | | |
|---------------------|------------------|------------|-----|-------|------|-----|-------|------------------|------------|----|------|------|-----|-------|
| | A2 ¹⁾ | D1 max. | D2 | EE | L1 | L2 | WH+A2 | A2 ¹⁾ | D1 max. | D2 | EE | L1 | L2 | WH+A2 |
| 10 ... 50 | 29 | 38 | 14 | G1/8 | 12.9 | 5.4 | 55 | 28 | 46 | 14 | G1/8 | 16.3 | 5.4 | 56.7 |
| 51 ... 125 | 47 | | | | | | 73 | 43 | | | | | | 71.7 |
| 126 ... 175 | 61 | | | | | | 87 | 56 | | | | | | 84.7 |
| 176 ... 250 | 80 | | | | | | 106 | 72 | | | | | | 100.7 |
| 251 ... 300 | 96 | | | | | | 122 | 86 | | | | | | 114.7 |
| 301 ... 350 | 112 | | | | | | 138 | 100 | | | | | | 128.7 |
| 351 ... 375 | 114 | | | | | | 140 | 101 | | | | | | 129.7 |
| 376 ... 425 | 130 | | | | | | 156 | 115 | | | | | | 143.7 |
| 426 ... 475 | 145 | | | | | | 171 | 130 | | | | | | 158.7 |
| 476 ... 500 | 147 | 173 | 131 | 159.7 | | | | | | | | | | |

| ∅ Stroke [mm] | 50 | | | | | | | 63 | | | | | | |
|---------------------|------------------|------------|-----|-------|-------|----|-------|------------------|------------|----|------|------|----|-------|
| | A2 ¹⁾ | D1 max. | D2 | EE | L1 | L2 | WH+A2 | A2 ¹⁾ | D1 max. | D2 | EE | L1 | L2 | WH+A2 |
| 10 ... 50 | 28 | 57 | 17 | G1/4 | 22.35 | 7 | 63.6 | 28 | 57 | 17 | G1/4 | 22.4 | 7 | 63.9 |
| 51 ... 125 | 46 | | | | | | 81.6 | 46 | | | | | | 81.9 |
| 126 ... 175 | 56 | | | | | | 91.6 | 56 | | | | | | 91.9 |
| 176 ... 250 | 73 | | | | | | 108.6 | 73 | | | | | | 108.9 |
| 251 ... 300 | 86 | | | | | | 121.6 | 86 | | | | | | 121.9 |
| 301 ... 350 | 97 | | | | | | 132.6 | 97 | | | | | | 132.9 |
| 351 ... 375 | 105 | | | | | | 140.6 | 105 | | | | | | 140.9 |
| 376 ... 425 | 116 | | | | | | 151.6 | 116 | | | | | | 151.9 |
| 426 ... 475 | 126 | | | | | | 161.6 | 126 | | | | | | 161.9 |
| 476 ... 500 | 134 | 169.6 | 134 | 169.9 | | | | | | | | | | |

| ∅ Stroke [mm] | 80 | | | | | | | 100 | | | | | | |
|---------------------|------------------|------------|-----|-------|----|----|-------|------------------|------------|----|------|----|----|-------|
| | A2 ¹⁾ | D1 max. | D2 | EE | L1 | L2 | WH+A2 | A2 ¹⁾ | D1 max. | D2 | EE | L1 | L2 | WH+A2 |
| 10 ... 50 | 25 | 93 | 17 | G1/4 | 28 | 4 | 70.4 | 25 | 93 | 17 | G1/4 | 28 | 4 | 74.3 |
| 51 ... 125 | 37 | | | | | | 82.4 | 37 | | | | | | 86.3 |
| 126 ... 175 | 49 | | | | | | 94.4 | 49 | | | | | | 98.3 |
| 176 ... 250 | 62 | | | | | | 107.4 | 62 | | | | | | 111.3 |
| 251 ... 300 | 74 | | | | | | 119.4 | 74 | | | | | | 123.3 |
| 301 ... 350 | 86 | | | | | | 131.4 | 86 | | | | | | 135.3 |
| 351 ... 375 | 87 | | | | | | 132.4 | 87 | | | | | | 136.3 |
| 376 ... 425 | 98 | | | | | | 143.4 | 98 | | | | | | 147.3 |
| 426 ... 475 | 110 | | | | | | 155.4 | 110 | | | | | | 159.3 |
| 476 ... 500 | 111 | 156.4 | 111 | 160.3 | | | | | | | | | | |

1) The dimension corresponds to the E value (piston rod extension) of the drive

Accessories

Ordering data – Bellows kit

An extended piston rod (order code E) is absolutely essential when using a bellows kit → Ordering data – Modular product system.

The necessary dimension for order code E as a function of piston diameter and cylinder stroke as well as the corresponding bellows kit is indicated in the table below:

Order example:

Selected standards-based cylinder:

DSBC-32-320-PPV-A-...

The dimension for the corresponding E value (see table):

112 mm

Complete order reference for standards-based cylinder:

DSBC-32-320-PPV-A-...-112E

The corresponding bellows kit:

DADB-V6-32-S301-350

| Cylinder data | | | Bellows kit | | Cylinder data | | | Bellows kit | |
|---------------|-------------|-----------------|---------------------|---------------------|---------------|-------------|----------------------|-------------|----------------------|
| ∅ | Stroke | Dimension for E | Part no. | Type | ∅ | Stroke | Dimension for E | Part no. | Type |
| [mm] | [mm] | [mm] | | | [mm] | [mm] | [mm] | | |
| 32 | 10 ... 50 | 29 | 553271 | DADB-V6-32-S10-50 | 40 | 10 ... 50 | 28 | 553291 | DADB-V6-40-S10-50 |
| | 51 ... 125 | 47 | 553273 | DADB-V6-32-S51-125 | | 51 ... 125 | 43 | 553293 | DADB-V6-40-S51-125 |
| | 126 ... 175 | 61 | 553275 | DADB-V6-32-S126-175 | | 126 ... 175 | 56 | 553295 | DADB-V6-40-S126-175 |
| | 176 ... 250 | 80 | 553277 | DADB-V6-32-S176-250 | | 176 ... 250 | 72 | 553297 | DADB-V6-40-S176-250 |
| | 251 ... 300 | 96 | 553279 | DADB-V6-32-S251-300 | | 251 ... 300 | 86 | 553399 | DADB-V6-40-S251-300 |
| | 301 ... 350 | 112 | 553281 | DADB-V6-32-S301-350 | | 301 ... 350 | 100 | 553301 | DADB-V6-40-S301-350 |
| | 351 ... 375 | 114 | 553283 | DADB-V6-32-S351-375 | | 351 ... 375 | 101 | 553303 | DADB-V6-40-S351-375 |
| | 376 ... 425 | 130 | 553285 | DADB-V6-32-S376-425 | | 376 ... 425 | 115 | 553305 | DADB-V6-40-S376-425 |
| | 426 ... 475 | 145 | 553287 | DADB-V6-32-S426-475 | | 426 ... 475 | 130 | 553307 | DADB-V6-40-S426-475 |
| 476 ... 500 | 147 | 553289 | DADB-V6-32-S476-500 | 476 ... 500 | 131 | 553309 | DADB-V6-40-S476-500 | | |
| 50 | 10 ... 50 | 28 | 553311 | DADB-V6-50-S10-50 | 63 | 10 ... 50 | 28 | 553331 | DADB-V6-63-S10-50 |
| | 51 ... 125 | 46 | 553313 | DADB-V6-50-S51-125 | | 51 ... 125 | 46 | 553333 | DADB-V6-63-S51-125 |
| | 126 ... 175 | 56 | 553315 | DADB-V6-50-S126-175 | | 126 ... 175 | 56 | 553335 | DADB-V6-63-S126-175 |
| | 176 ... 250 | 73 | 553317 | DADB-V6-50-S176-250 | | 176 ... 250 | 73 | 553337 | DADB-V6-63-S176-250 |
| | 251 ... 300 | 86 | 553319 | DADB-V6-50-S251-300 | | 251 ... 300 | 86 | 553339 | DADB-V6-63-S251-300 |
| | 301 ... 350 | 97 | 553321 | DADB-V6-50-S301-350 | | 301 ... 350 | 97 | 553341 | DADB-V6-63-S301-350 |
| | 351 ... 375 | 105 | 553323 | DADB-V6-50-S351-375 | | 351 ... 375 | 105 | 553343 | DADB-V6-63-S351-375 |
| | 376 ... 425 | 116 | 553325 | DADB-V6-50-S376-425 | | 376 ... 425 | 116 | 553345 | DADB-V6-63-S376-425 |
| | 426 ... 475 | 126 | 553327 | DADB-V6-50-S426-475 | | 426 ... 475 | 126 | 553347 | DADB-V6-63-S426-475 |
| 476 ... 500 | 134 | 553329 | DADB-V6-50-S476-500 | 476 ... 500 | 134 | 553349 | DADB-V6-63-S476-500 | | |
| 80 | 10 ... 50 | 25 | 553351 | DADB-V6-80-S10-50 | 100 | 10 ... 50 | 25 | 553371 | DADB-V6-100-S10-50 |
| | 51 ... 125 | 37 | 553353 | DADB-V6-80-S51-125 | | 51 ... 125 | 37 | 553373 | DADB-V6-100-S51-125 |
| | 126 ... 175 | 49 | 553355 | DADB-V6-80-S126-175 | | 126 ... 175 | 49 | 553375 | DADB-V6-100-S126-175 |
| | 176 ... 250 | 62 | 553357 | DADB-V6-80-S176-250 | | 176 ... 250 | 62 | 553377 | DADB-V6-100-S176-250 |
| | 251 ... 300 | 74 | 553359 | DADB-V6-80-S251-300 | | 251 ... 300 | 74 | 553379 | DADB-V6-100-S251-300 |
| | 301 ... 350 | 86 | 553361 | DADB-V6-80-S301-350 | | 301 ... 350 | 86 | 553381 | DADB-V6-100-S301-350 |
| | 351 ... 375 | 87 | 553363 | DADB-V6-80-S351-375 | | 351 ... 375 | 87 | 553383 | DADB-V6-100-S351-375 |
| | 376 ... 425 | 98 | 553365 | DADB-V6-80-S376-425 | | 376 ... 425 | 98 | 553385 | DADB-V6-100-S376-425 |
| | 426 ... 475 | 110 | 553367 | DADB-V6-80-S426-475 | | 426 ... 475 | 110 | 553387 | DADB-V6-100-S426-475 |
| 476 ... 500 | 111 | 553369 | DADB-V6-80-S476-500 | 476 ... 500 | 111 | 553389 | DADB-V6-100-S476-500 | | |

Accessories

Multi-position kit DPNC

Material:
 Flange: Wrought aluminium alloy
 Threaded pins, hex nuts: Galvanised steel

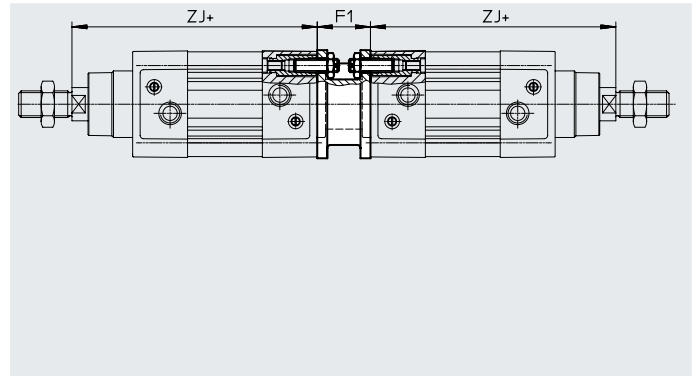

Dimensions and ordering data

| For diam. [mm] | F1 | ZJ | | Max. complete stroke [mm] | Weight [g] | Part no. | Type ¹⁾ |
|-------------------|----|-----------------|-----------|------------------------------|---------------|----------|--------------------|
| | | DSBC... +1.8 | DSBC...-C | | | | |
| 32 | 27 | 119.1 | 164.1 | 500 | 292 | 174418 | DPNC-32 |
| 40 | 27 | 133.9 | 186.9 | 800 | 410 | 174419 | DPNC-40 |
| 50 | 32 | 141.8 | 208.8 | 800 | 335 | 174420 | DPNC-50 |
| 63 | 28 | 157.1 | 233.1 | 700 | 390 | 174421 | DPNC-63 |
| 80 | 38 | 173.6 | 268.6 | 1000 | 847 | 174422 | DPNC-80 |
| 100 | 38 | 187.5 | 285.7 | 900 | 1200 | 174423 | DPNC-100 |
| 125 | 48 | 225 | 349.3 | 1000 | 2102 | 174424 | DPNC-125 |

1) Suitable for ATEX

Note

The maximum overall stroke length must not be exceeded when combining cylinders and multi-position kits.

Connecting two cylinders with identical piston diameters to form a 3 or 4-position cylinder

A 3 or 4-position cylinder consists of two separate cylinders whose piston rods advance in opposing directions.

This means that, depending on the control and the stroke pattern, this type of cylinder can assume up to four positions, each of which

moves exactly to the stop. Note that when one end of the piston rod is fixed, the cylinder barrel executes the

movement. The line connections to the cylinder must therefore be flexible.

To achieve 3 positions

Two cylinders with identical stroke length must be connected together.

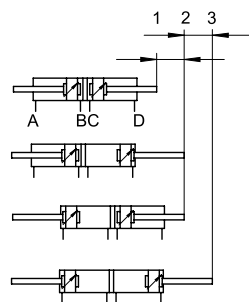

To achieve 4 positions

Two cylinders with different stroke lengths must be connected together.

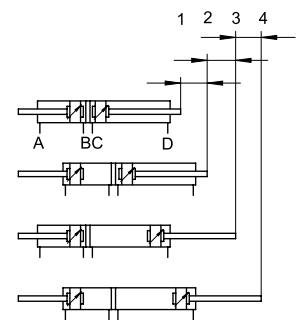

Accessories

Mounting kit DAVM

For lateral valve mounting, directly on the drive

Material:
Mounting bracket, screws: Galvanised steel
Slot nut: High-alloy stainless steel

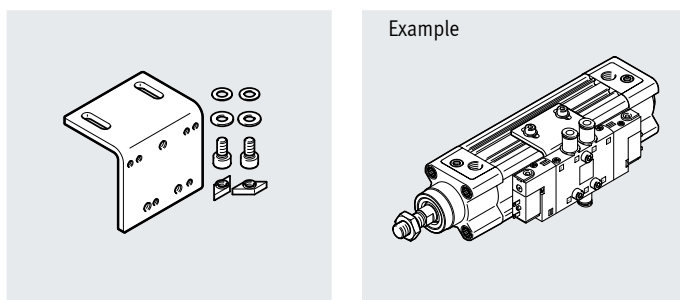

The hole pattern on the angle bracket enables solenoid valves to be attached on the right according to the assignment. The following table shows a few solenoid valves that are available.

Allocation table, mounting kit for solenoid valves

| Mounting kit | Solenoid valve | | |
|-----------------|----------------|----------|--------------------|
| DAVM-MW-V1-32-V | CPE14 | VUVG-L14 | VUVS-L20 |
| DAVM-MW-V1-50-V | CPE18, CPE24 | VUVG-L18 | VUVS-L25, VUVS-L30 |

Recommended solenoid valves CPE

Data sheets → Internet: cpe



| | For diam. [mm] | Mounting screw | Pneumatic connection | Function | Part no. | Type |
|--------------|------------------------|----------------|----------------------|---------------|-------------------------|--------------------------|
| | Single solenoid | | | | | |
| | 32, 40 | M4x20 | G1/8 | 5/2-way valve | 196941 | CPE14-M1BH-5L-1/8 |
| | 50, 63 | M4x25 | G1/4 | | 163142 | CPE18-M1H-5L-1/4 |
| | 80, 100, 125 | M5x30 | G3/8 | | 163166 | CPE24-M1H-5L-3/8 |
| | Double solenoid | | | | | |
| | 32, 40 | M4x20 | G1/8 | 5/2-way valve | 196939 | CPE14-M1BH-5J-1/8 |
| 50, 63 | M4x25 | G1/4 | 163143 | | CPE18-M1H-5J-1/4 | |
| 80, 100, 125 | M5x30 | G3/8 | 163167 | | CPE24-M1H-5J-3/8 | |

Accessories for solenoid valves CPE

| | For valve | Cable length [m] | Part no. | Type |
|-----------------------------------|-----------|------------------|-----------------|-------------------------------------|
| Connecting cable NEBV/KMEB | | | | |
| Data sheets → Internet: nebv | | | | |
| | CPE14 | 2.5 | 8047679 | NEBV-Z4WA2L-R-E-2.5-N-LE2-S1 |
| | | 5 | 8047680 | NEBV-Z4WA2L-R-E-5-N-LE2-S1 |
| | CPE18 | 2.5 | ★ 151688 | KMEB-1-24-2.5-LED |
| | CPE24 | 5 | 151689 | KMEB-1-24-5-LED |
| | | 10 | 193457 | KMEB-1-24-10-LED |

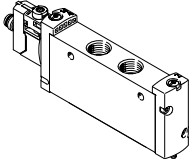
Accessories

| Recommended solenoid valves VUVG | | | | | | Data sheets → Internet: vuvg |
|---|------------------------|----------------|-------------------------|---------------|-----------|------------------------------|
| | For diam. [mm] | Mounting screw | Pneumatic connection | Function | Part no. | Type |
|  | Single solenoid | | | | | |
| | 32, 40 | M3x20 | G1/8 | 5/2-way valve | ★ 8031508 | VUVG-L14-M52-MT-G18-1R8L |
| | 50, 63 | M4x25 | G1/4 | | ★ 8031532 | VUVG-L18-M52-MT-G14-1R8L |
| | Double solenoid | | | | | |
| | 32, 40 | M3x20 | G1/8 | 5/2-way valve | ★ 574230 | VUVG-L14-B52-T-G18-1R8L |
| | 50, 63 | M4x25 | G1/4 | | ★ 8031533 | VUVG-L18-B52-T-G14-1R8L |

| Accessories for solenoid valves VUVG | | | | | | Data sheets → Internet: nebu |
|---|-----------|---------------------------------|--------------|----------|---------------------|------------------------------|
| | For valve | Electrical connection | Cable length | Part no. | Type | |
| Connecting cable NEBU | | | | | | |
|  | VUVG-L14 | Straight socket, M8x1, 3-pin | 2.5 m | ★ 541333 | NEBU-M8G3-K-2.5-LE3 | |
| | VUVG-L18 | | 5 m | ★ 541334 | NEBU-M8G3-K-5-LE3 | |
|  | | Angled socket, M8x1, 3-pin | 2.5 m | ★ 541338 | NEBU-M8W3-K-2.5-LE3 | |
| | | | 5 m | ★ 541341 | NEBU-M8W3-K-5-LE3 | |

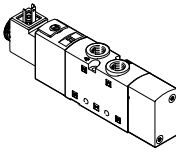
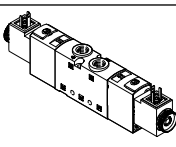
| Recommended solenoid valves VUVS | | | | | | Data sheets → Internet: vuvs |
|---|--------------------------------|----------------|-------------------------|---------------|----------------------------|------------------------------|
| | For diam. [mm] | Mounting screw | Pneumatic connection | Function | Part no. | Type |
|  | Single solenoid, type C | | | | | |
| | 32, 40 | M3x20 | G1/8 | 5/2-way valve | ★ 575263 | VUVS-L20-M52-AD-G18-F7-1C1 |
| | | | | | ★ 575264 | VUVS-L20-M52-MD-G18-F7-1C1 |
| | 50, 63 | M4x20 | G1/4 | | ★ 575503 | VUVS-L25-M52-AD-G14-F8-1C1 |
| | | | | | ★ 575511 | VUVS-L25-M52-MD-G14-F8-1C1 |
| | 80, 100, 125 | M5x30 | G3/8 | | ★ 575596 | VUVS-L30-M52-AD-G38-F8-1C1 |
| | | | ★ 575604 | | VUVS-L30-M52-MD-G38-F8-1C1 | |
|  | Double solenoid, type C | | | | | |
| | 32, 40 | M3x20 | G1/8 | 5/2-way valve | ★ 575265 | VUVS-L20-B52-D-G18-F7-1C1 |
| | 50, 63 | M4x20 | G1/4 | | ★ 575518 | VUVS-L25-B52-D-G14-F8-1C1 |
| | 80, 100, 125 | M5x30 | G3/8 | | ★ 575611 | VUVS-L30-B52-D-G38-F8-1C1 |
| | | | | | | |

| Accessories for solenoid valves VUVS | | | | | | Part no. | Type | |
|---|--|---------------------|-------------------|------|----------|----------|------|--|
| Plug socket MSSD | | | | | | | | |
|  | Plug pattern type C, to DIN EN 175301-803 | | | | | | | |
| | 3-pin, screw terminal | Cable connector Pg7 | 0 ... 250 V AC/DC | IP65 | ★ 151687 | MSSDEB | | |

 **Note**

Dimensions and ordering data
→ Page 1

Accessories

Dimensions and ordering data

Download CAD data → www.festo.com

DAVM-MW-V1-32-V

DAVM-MW-V1-50-V

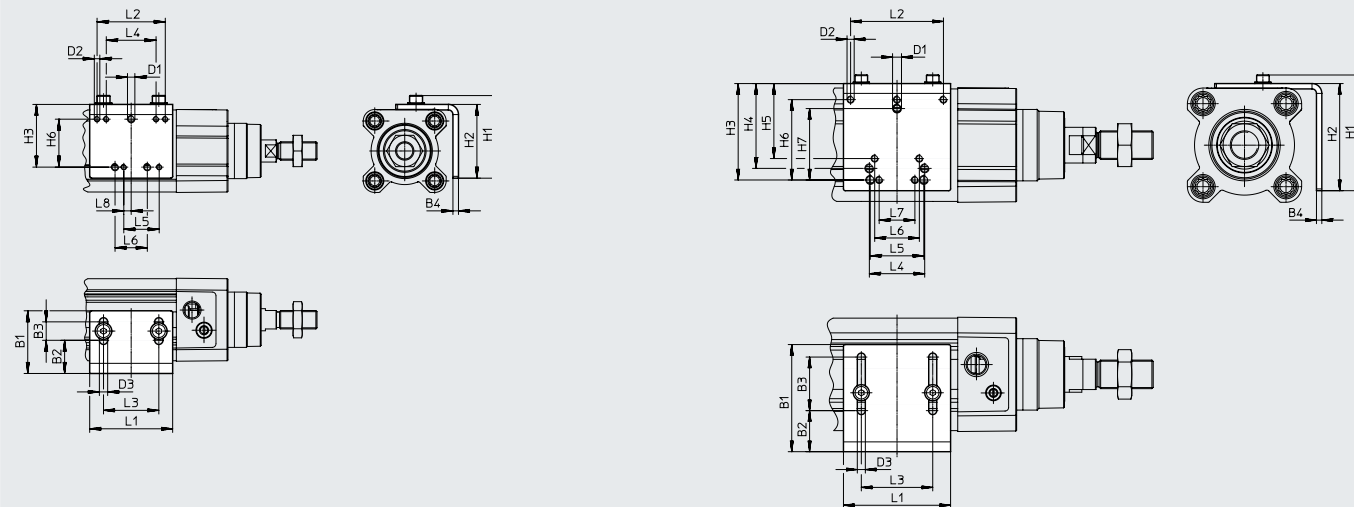

Note
 Mounting is only possible on the side on which the pneumatic connections are located. Two slot nuts are included in the scope of delivery of the mounting kit. Additional slot nuts → page 62

| For diam. [mm] | B1 | B2 | B3 | B4 | D1 | D2 | D3 ∅ | H1 | H2 | H3 | H4 | H5 | H6 | H7 |
|----------------|----|----|----|----|----|----|---------|------|----|----|------|----|----|----|
| 32 | 34 | 18 | 10 | 3 | M4 | M3 | 4.5 | 44.8 | 40 | 34 | - | - | 26 | - |
| 40 | | | | | | | | | | | | | | |
| 50 | 60 | 23 | 30 | 3 | M5 | M4 | 4.5 | 64.8 | 60 | 54 | 47.5 | 42 | 45 | 40 |
| 63 | | | | | | | | | | | | | | |
| 80 | | | | | | | | | | | | | | |
| 100 | | | | | | | | | | | | | | |
| 125 | | | | | | | | | | | | | | |

| For diam. [mm] | L1 | L2 | L3 | L4 | L5 | L6 | L7 | L8 | CRC1) | Weight [g] | Part no. | Type |
|----------------|----|----|----|----|------|------|----|----|-------|------------|----------|-----------------|
| 32 | 45 | 37 | 30 | 27 | 19.2 | 17.5 | - | 4 | 1 | 76 | 2568514 | DAVM-MW-V1-32-V |
| 40 | | | | | | | | | | | | |
| 50 | 60 | 52 | 40 | 31 | 30 | 25 | 20 | - | 1 | 160 | 2612128 | DAVM-MW-V1-50-V |
| 63 | | | | | | | | | | | | |
| 80 | | | | | | | | | | | | |
| 100 | | | | | | | | | | | | |
| 125 | | | | | | | | | | | | |

1) Corrosion resistance class CRC 1 to Festo standard FN 940070
 Low corrosion stress. Dry internal application or transport and storage protection. Also applies to parts behind coverings, in the non-visible interior area, and parts which are covered in the application (e.g. drive trunnions).

Accessories

Ordering data – Guide units for fixed strokes (recirculating ball bearing guide only)

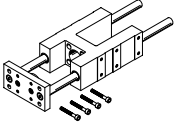

| Stroke [mm] | Part no. | Type ¹⁾ |
|------------------------|----------|--------------------|
| For diam. 32 mm | | |
| 10 ... 50 | 34493 | FENG-32-50-KF |
| 10 ... 100 | 34494 | FENG-32-100-KF |
| 10 ... 160 | 34495 | FENG-32-160-KF |
| 10 ... 200 | 34496 | FENG-32-200-KF |
| 10 ... 250 | 150289 | FENG-32-250-KF |
| 10 ... 320 | 34497 | FENG-32-320-KF |
| 10 ... 400 | 150290 | FENG-32-400-KF |
| 10 ... 500 | 34498 | FENG-32-500-KF |
| For diam. 50 mm | | |
| 10 ... 50 | 34506 | FENG-50-50-KF |
| 10 ... 100 | 34507 | FENG-50-100-KF |
| 10 ... 160 | 34508 | FENG-50-160-KF |
| 10 ... 200 | 34509 | FENG-50-200-KF |
| 10 ... 250 | 34510 | FENG-50-250-KF |
| 10 ... 320 | 34511 | FENG-50-320-KF |
| 10 ... 400 | 150292 | FENG-50-400-KF |
| 10 ... 500 | 34512 | FENG-50-500-KF |
| For diam. 80 mm | | |
| 10 ... 50 | 34521 | FENG-80-50-KF |
| 10 ... 100 | 34522 | FENG-80-100-KF |
| 10 ... 160 | 34523 | FENG-80-160-KF |
| 10 ... 200 | 34524 | FENG-80-200-KF |
| 10 ... 250 | 34525 | FENG-80-250-KF |
| 10 ... 320 | 34526 | FENG-80-320-KF |
| 10 ... 400 | 34527 | FENG-80-400-KF |
| 10 ... 500 | 34528 | FENG-80-500-KF |

Ordering data – Guide units for fixed strokes (plain-bearing guide only)

| Stroke [mm] | Part no. | Type ¹⁾ |
|-------------------------|----------|--------------------|
| For diam. 40 mm | | |
| 10 ... 50 | 34499 | FENG-40-50-KF |
| 10 ... 100 | 34500 | FENG-40-100-KF |
| 10 ... 160 | 34501 | FENG-40-160-KF |
| 10 ... 200 | 34502 | FENG-40-200-KF |
| 10 ... 250 | 34503 | FENG-40-250-KF |
| 10 ... 320 | 34504 | FENG-40-320-KF |
| 10 ... 400 | 150291 | FENG-40-400-KF |
| 10 ... 500 | 34505 | FENG-40-500-KF |
| For diam. 63 mm | | |
| 10 ... 50 | 34513 | FENG-63-50-KF |
| 10 ... 100 | 34514 | FENG-63-100-KF |
| 10 ... 160 | 34515 | FENG-63-160-KF |
| 10 ... 200 | 34516 | FENG-63-200-KF |
| 10 ... 250 | 34517 | FENG-63-250-KF |
| 10 ... 320 | 34518 | FENG-63-320-KF |
| 10 ... 400 | 34519 | FENG-63-400-KF |
| 10 ... 500 | 34520 | FENG-63-500-KF |
| For diam. 100 mm | | |
| 10 ... 50 | 34529 | FENG-100-50-KF |
| 10 ... 100 | 34530 | FENG-100-100-KF |
| 10 ... 160 | 34531 | FENG-100-160-KF |
| 10 ... 200 | 34532 | FENG-100-200-KF |
| 10 ... 250 | 34533 | FENG-100-250-KF |
| 10 ... 320 | 34534 | FENG-100-320-KF |
| 10 ... 400 | 34535 | FENG-100-400-KF |
| 10 ... 500 | 34536 | FENG-100-500-KF |

Data sheets → Internet: feng

Ordering data – Guide units for variable strokes

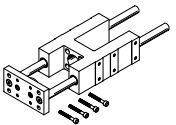

| For diam. [mm] | Stroke [mm] | With recirculating ball bearing guide | | With plain-bearing guide | |
|----------------|-------------|---------------------------------------|--------------------|--------------------------|--------------------|
| | | Part no. | Type ¹⁾ | Part no. | Type ¹⁾ |
| 32 | 10 ... 500 | 34487 | FENG-32-...-KF | 34481 | FENG-32-...-GF |
| 40 | 10 ... 500 | 34488 | FENG-40-...-KF | 34482 | FENG-40-...-GF |
| 50 | 10 ... 500 | 34489 | FENG-50-...-KF | 34483 | FENG-50-...-GF |
| 63 | 10 ... 500 | 34490 | FENG-63-...-KF | 34484 | FENG-63-...-GF |
| 80 | 10 ... 500 | 34491 | FENG-80-...-KF | 34485 | FENG-80-...-GF |
| 100 | 10 ... 500 | 34492 | FENG-100-...-KF | 34486 | FENG-100-...-GF |

Data sheets → Internet: feng

1) Suitable for ATEX

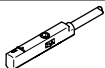
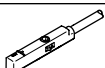

Accessories

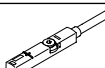
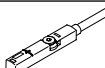
| Ordering data – Proximity switches for T-slot, magneto-resistive | | | | | | | Data sheets → Internet: smt |
|--|--|------------------|-----------------------|------------------|----------|---------------------------|-----------------------------|
| | Type of mounting | Switching output | Electrical connection | Cable length [m] | Part no. | Type | |
| N/O contact | | | | | | | |
|  | Insertable in the slot from above, flush with the cylinder profile, short design | PNP | Cable, 3-wire | 2.5 | ★ 574335 | SMT-8M-A-PS-24V-E-2,5-OE | |
| | | | Plug M8x1, 3-pin | 0.3 | ★ 574334 | SMT-8M-A-PS-24V-E-0,3-M8D | |
| | | | Plug M12x1, 3-pin | 0.3 | ★ 574337 | SMT-8M-A-PS-24V-E-0,3-M12 | |
| | | NPN | Cable, 3-wire | 2.5 | ★ 574338 | SMT-8M-A-NS-24V-E-2,5-OE | |
| | | | Plug M8x1, 3-pin | 0.3 | ★ 574339 | SMT-8M-A-NS-24V-E-0,3-M8D | |
| N/C contact | | | | | | | |
|  | Insertable in the slot from above, flush with the cylinder profile, short design | PNP | Cable, 3-wire | 7.5 | ★ 574340 | SMT-8M-A-PO-24V-E-7.5-OE | |

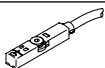
| Ordering data – Proximity switches for T-slot, magnetic reed | | | | | | | Data sheets → Internet: sme | |
|---|--|------------------|-----------------------|------------------|----------|-------------------------|-----------------------------|--|
| | Type of mounting | Switching output | Electrical connection | Cable length [m] | Part no. | Type | | |
| N/O contact | | | | | | | | |
|  | Insertable in the slot from above, flush with the cylinder profile | Contacting | Cable, 3-wire | 2.5 | ★ 543862 | SME-8M-DS-24V-K-2,5-OE | | |
| | | | | 5.0 | ★ 543863 | SME-8M-DS-24V-K-5,0-OE | | |
| | | | Plug M8x1, 3-pin | Cable, 2-wire | 2.5 | ★ 543872 | SME-8M-ZS-24V-K-2,5-OE | |
| | | | | 0.3 | ★ 543861 | SME-8M-DS-24V-K-0,3-M8D | | |
| N/C contact | | | | | | | | |
|  | Insertable in the slot from above, flush with the cylinder profile | Contacting | Cable, 3-wire | 7.5 | ★ 546799 | SME-8M-DO-24V-K-7.5-OE | | |

| Ordering data – Proximity switch for T-slot, magneto-resistive, for ATEX zone | | | | | | | Data sheets → Internet: smt | |
|--|--|---------------|-------|------------------|-----------------------|------------------|-----------------------------|-------------------------------|
| | Type of mounting | ATEX category | | Switching output | Electrical connection | Cable length [m] | Part no. | Type |
| | | Gas | Dust | | | | | |
| N/O contact | | | | | | | | |
|  | Insertable in the slot from above, flush with the cylinder profile, short design | II 3G | II 3D | PNP | Plug M8x1, 3-wire | 0.3 | 574342 | SMT-8M-A-PS-24V-E-0,3-M8D-EX2 |

| Ordering data – Safety clip for ATEX zone | | | | | | |
|--|--|-----------|----------|------------|--|--|
| | Description | For size | Part no. | Type | | |
|  | <ul style="list-style-type: none"> Protects "equipment that is not intrinsically safe" against simple disconnection, here the plug of the proximity switch SMT and connecting cable NEBU ATEX category: gas: II 3G / dust: II 3D | Plug M8x1 | 548067 | NEAU-M8-GD | | |

| Ordering data – Connecting cables | | | | | Data sheets → Internet: nebu |
|--|-------------------------------|------------------------------|------------------|----------|------------------------------|
| | Electrical connection, left | Electrical connection, right | Cable length [m] | Part no. | Type |
|  | Straight socket, M8x1, 3-pin | Cable, open end, 3-wire | 2.5 | ★ 541333 | NEBU-M8G3-K-2.5-LE3 |
| | | | 5 | ★ 541334 | NEBU-M8G3-K-5-LE3 |
| | Straight socket, M12x1, 5-pin | Cable, open end, 3-wire | 2.5 | ★ 541363 | NEBU-M12G5-K-2.5-LE3 |
| | | | 5 | ★ 541364 | NEBU-M12G5-K-5-LE3 |
|  | Angled socket, M8x1, 3-pin | Cable, open end, 3-wire | 2.5 | ★ 541338 | NEBU-M8W3-K-2.5-LE3 |
| | | | 5 | ★ 541341 | NEBU-M8W3-K-5-LE3 |
| | Angled socket, M12x1, 5-pin | Cable, open end, 3-wire | 2.5 | 541367 | NEBU-M12W5-K-2.5-LE3 |
| | | | 5 | 541370 | NEBU-M12W5-K-5-LE3 |



Accessories

Position transmitter

The position transmitter continuously senses the position of the piston.

It has an analogue output with an output signal in proportion to the piston position.

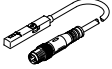
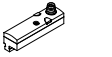
Ordering data – Position transmitters for T-slot

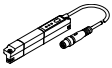
| | For diam. | Position measuring range | Analogue output | | Type of mounting | Electrical connection | Cable length [m] | Part no. | Type |
|---|------------|--------------------------|-----------------|----------|---|---------------------------|------------------|----------------|-------------------------------------|
| | | | [V] | [mA] | | | | | |
|  | 32 ... 125 | 0 ... 40 | 0 ... 10 | – | Inserted in slot from above | Plug M8x1, 4-pin, in-line | 0.3 | 553744 | SMAT-8M-U-E-0,3-M8D |
|  | 32 ... 125 | 0 ... 50 | 0 ... 10 | 4 ... 20 | Inserted into the slot lengthwise ¹⁾ | Plug M8x1, 4-pin, lateral | – | 540191 | SMAT-8E-S50-IU-M8 |
|  | | | | | | Plug M8x1, 4-pin, in-line | 0.3 | 570134 | SMAT-8E-S50-IU-E-0,3-M8D |
|  | 32 ... 125 | 0 ... 50 | – | 4 ... 20 | Inserted in slot from above | Plug M8x1, 4-pin, in-line | 0.3 | 1531265 | SDAT-MHS-M50-1L-SA-E-0.3-M8 |
| | | 0 ... 80 | | | | | | 1531266 | SDAT-MHS-M80-1L-SA-E-0.3-M8 |
| | | 0 ... 100 | | | | | | 1531267 | SDAT-MHS-M100-1L-SA-E-0.3-M8 |
| | | 0 ... 125 | | | | | | 1531268 | SDAT-MHS-M125-1L-SA-E-0.3-M8 |
| | | 0 ... 160 | | | | | | 1531269 | SDAT-MHS-M160-1L-SA-E-0.3-M8 |

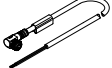

1) Can only be used in combination with DSBC...-D3.

Ordering data – Connecting cables

| | Electrical connection, left | Electrical connection, right | Cable length [m] | Part no. | Type |
|---|-----------------------------|------------------------------|------------------|---------------|----------------------------|
| | | | | | |
| 5 | 541343 | NEBU-M8G4-K-5-LE4 | | | |
|  | Angled socket, M8x1, 4-pin | Cable, open end, 4-wire | 2.5 | 541344 | NEBU-M8W4-K-2.5-LE4 |
| | | | 5 | 541345 | NEBU-M8W4-K-5-LE4 |

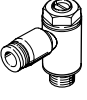
Accessories

| Ordering data – One-way flow control valves | | | | Data sheets → Internet: gria | | |
|--|----------|-----------------|---------------|------------------------------|------------------|--|
| Connection | Material | | Part no. | Type | | |
| | Thread | For tubing O.D. | | | | |
| For exhaust air | | | | | | |
|  | G1/8 | 4 | Metal version | ★ 193143 | GRLA-1/8-QS-4-D | |
| | | 6 | | ★ 193144 | GRLA-1/8-QS-6-D | |
| | | 8 | | ★ 193145 | GRLA-1/8-QS-8-D | |
| | G1/4 | 6 | | ★ 193146 | GRLA-1/4-QS-6-D | |
| | | 8 | | ★ 193147 | GRLA-1/4-QS-8-D | |
| | | 10 | | ★ 193148 | GRLA-1/4-QS-10-D | |
| | G3/8 | 6 | | ★ 193149 | GRLA-3/8-QS-6-D | |
| | | 8 | | ★ 193150 | GRLA-3/8-QS-8-D | |
| | | 10 | | ★ 193151 | GRLA-3/8-QS-10-D | |
| | G1/2 | 12 | | ★ 193152 | GRLA-1/2-QS-12-D | |

| Ordering data | | | |
|---|----------|-------------------|------------------|
| Description | Part no. | Type | PU ¹⁾ |
| Slot cover for T-slot | | | |
|  Insertable, length 0.5 m | 151680 | ABP-5-S | 2 |
| Slot nut for T-slot | | | |
|  Inserted in the slot from above, thread M4 | 8028500 | ABAN-8-1M4-5-P2 | 2 |
| | 8028501 | ABAN-8-1M4-5-P100 | 100 |

1) Packaging unit