

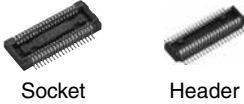

• Without soldering terminal

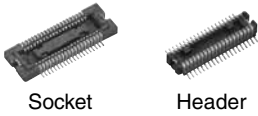

• With soldering terminal



Compliance with RoHS Directive

FEATURES

- 0.4 mm pitch and support for mated heights of up to 1.5 mm, 2.0 mm, 2.5 mm, 3.0 mm, 3.5 mm, and 4.0 mm.
- Strong resistance to adverse environments! Utilizes **TOUGH CONTACT** construction for high contact reliability. (See Page 6 for details of the structure)
- It is constructed with impact dispersion keys inside the body to disperse shocks when dropped.

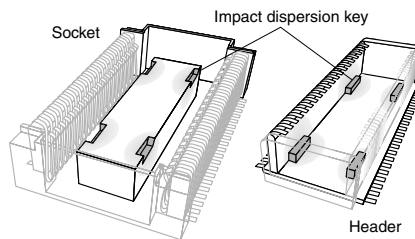

A high level of shock resistance is ensured by dispersing impact over the four locations where the socket indentations and header protrusions are mated together.

Note: The following numbers of contacts are not supported due to suction surface factors.

- Without soldering terminal: 18 contacts or less
- With soldering terminal: 22 contacts or less

4. Construction makes designing devices easier.

1) The lower connector bottom surface construction prevents contact and shorts between the PCB and metal terminals. This enables freedom in pattern wiring, helping to make PCB's smaller.

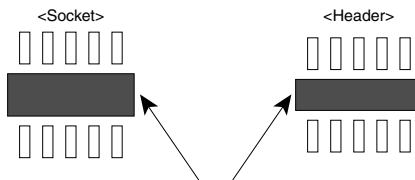

Connector bottom: Create any thru-hole and pattern wiring.

2) Guides are provided to take up any position shift and facilitate insertion.

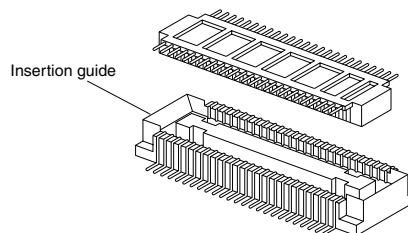

3) The connector has a simple lock mechanism. Superior mated operation with click feel to indicate that mated is complete.

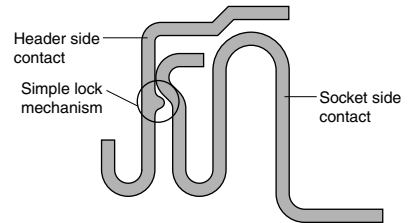

5. Design makes efficient mounting. Features a terminal flatness of 0.08 mm, construction resistant to creeping flux, and design that facilitates visual inspection of the soldered part.

6. Connectors for inspection available. Connectors for inspection are available that are ideal for modular unit inspection and inspection in device assembly processes.

APPLICATIONS

Compact portable devices "Cellular phones, DVC, Digital cameras, etc"

Ideal for Board-to-FPC connections

Before mating

↓

After mating

The simple lock mechanism ensures that the connector clicks into position when it is inserted for reliable single-action insertion on the PCB. This enables the number of pins to be doubled while the size remains the same as that for existing FPC connectors. This, in turn, contributes to making products and equipment more compact.

ORDERING INFORMATION

AXK **G**

7: Narrow Pitch Connector P4 (0.4 mm pitch) Socket

8: Narrow Pitch Connector P4 (0.4 mm pitch) Header

Number of contacts (2 digits)

Mated height

<Socket>

1: For mated height 1.5 mm

2: For mated height 2.0 mm

3: For mated height 2.5 mm and 3.0 mm

4: For mated height 3.5 mm

5: For mated height 4.0 mm

<Header>

1: For mated height 1.5 mm, 2.0 mm and 2.5 mm

2: For mated height 3.0 mm, 3.5 mm and 4.0 mm

Functions

2: With soldering terminal, without positioning bosses

4: Without soldering terminal, without positioning bosses

Surface treatment (Contact portion / Terminal portion)

<Socket>

7: Ni plating on base, Au plating on surface (for Ni barrier available)

<Header>

5: Ni plating on base, Au plating on surface

Other specifications

<Header>

W: V notch and post edge horseshoe bend type product

Packing

G: 3,000 pieces embossed tape and plastic reel × 2*

Notes: 1. Only a socket of mated height 3.5 mm and 4.0 mm: 2,000 pieces embossed tape and plastic reel × 2.

2. Please note that the models with a soldering terminal (8th digit of part number is "2") and those without a soldering terminal (8th digit of part number is "4") are shaped differently and are not compatible.

AXK7, 8

PRODUCT TYPES

1. Without soldering terminal

Mated height	Number of contacts	Part number		Packing				
		Socket	Header	Inner carton	Outer carton			
		<i>TOUGH CONTACT</i>	<i>TOUGH CONTACT</i>					
1.5 mm	14	AXK714147G	AXK814145WG	3,000 pieces	6,000 pieces			
	16	AXK716147G	AXK816145WG					
	20	AXK720147G	AXK820145WG					
	22	AXK722147G	AXK822145WG					
	24	AXK724147G	AXK824145WG					
	26	AXK726147G	AXK826145WG					
	28	AXK728147G	AXK828145WG					
	30	AXK730147G	AXK830145WG					
	34	AXK734147G	AXK834145WG					
	36	AXK736147G	AXK836145WG					
	40	AXK740147G	AXK840145WG					
	42	AXK742147G	AXK842145WG					
	44	AXK744147G	AXK844145WG					
	50	AXK750147G	AXK850145WG					
	54	AXK754147G	AXK854145WG					
	60	AXK760147G	AXK860145WG					
	2.0 mm	14	AXK714247G			AXK814145WG	3,000 pieces	6,000 pieces
		20	AXK720247G			AXK820145WG		
24		AXK724247G	AXK824145WG					
26		AXK726247G	AXK826145WG					
30		AXK730247G	AXK830145WG					
34		AXK734247G	AXK834145WG					
38		AXK738247G	AXK838145WG					
40		AXK740247G	AXK840145WG					
50		AXK750247G	AXK850145WG					
60		AXK760247G	AXK860145WG					
70		AXK770247G	AXK870145WG					
80		AXK780247G	AXK880145WG					
100	AXK700247G	AXK800145WG						
2.5 mm	14	AXK714347G	AXK814145WG	3,000 pieces	6,000 pieces			
	20	AXK720347G	AXK820145WG					
	24	AXK724347G	AXK824145WG					
	30	AXK730347G	AXK830145WG					
	34	AXK734347G	AXK834145WG					
	40	AXK740347G	AXK840145WG					
	44	AXK744347G	AXK844145WG					
	50	AXK750347G	AXK850145WG					
	60	AXK760347G	AXK860145WG					
	70	AXK770347G	AXK870145WG					
	80	AXK780347G	AXK880145WG					
90	AXK790347G	AXK890145WG						
100	AXK700347G	AXK800145WG						
3.0 mm	24	AXK724347G	AXK824245WG	3,000 pieces	6,000 pieces			
	30	AXK730347G	AXK830245WG					
	50	AXK750347G	AXK850245WG					
	80	AXK780347G	AXK880245WG					
3.5 mm	30	AXK730447G	AXK830245WG	3,000 pieces	6,000 pieces			
	40	AXK740447G	AXK840245WG					
4.0 mm	24	AXK724547G	AXK824245WG	3,000 pieces	6,000 pieces			

Notes: 1. Regarding ordering units; During production: Please make orders in 1-reel units.

Samples for mounting confirmation: Available in units of 50 pieces. Please consult us. (See "Regarding sample orders to confirm proper mounting" on page 19.)

Samples: Small lot orders are possible.

2. The above part numbers are for connectors without positioning bosses, which are standard. When ordering connectors with positioning bosses, please contact our sales office.

3. "W" indicates a product with V notch and post edge horseshoe bend. ("Post edge horseshoe bend" refers to a construction that makes it difficult for the header post edge to deform when the connector is inserted and removed at an angle.)

4. Previous V notch types ("Y" in 10 th place of the header part number) and the current V notch + post edge horseshoe bend types ("W" in the 10 th place of the header part number) are compatible for mating.

5. Connectors of different mated height (3.0 mm, 3.5 mm and 4.0 mm) and different number of contacts are available on-demand production only. Please contact us for more details.

2. With soldering terminal  **TOUGH CONTACT**

Mated height	Number of contacts	Part number		Packing	
		Socket	Header	Inner carton	Outer carton
		<i>TOUGH CONTACT</i>	<i>TOUGH CONTACT</i>		
1.5 mm	10	AXK710127G	AXK810125WG	3,000 pieces	6,000 pieces
	12	AXK712127G	AXK812125WG		
	20	AXK720127G	AXK820125WG		
	22	AXK722127G	AXK822125WG		
	24	AXK724127G	AXK824125WG		
	28	AXK728127G	AXK828125WG		
	30	AXK730127G	AXK830125WG		
	34	AXK734127G	AXK834125WG		
	36	AXK736127G	AXK836125WG		
	40	AXK740127G	AXK840125WG		
	44	AXK744127G	AXK844125WG		
	46	AXK746127G	AXK846125WG		
	50	AXK750127G	AXK850125WG		
	60	AXK760127G	AXK860125WG		
2.0 mm	20	AXK720227G	AXK820125WG	3,000 pieces	6,000 pieces
	24	AXK724227G	AXK824125WG		
	40	AXK740227G	AXK840125WG		
	50	AXK750227G	AXK850125WG		
	60	AXK760227G	AXK860125WG		
	80	AXK780227G	AXK880125WG		
2.5 mm	12	AXK712327G	AXK812125WG	3,000 pieces	6,000 pieces
	20	AXK720327G	AXK820125WG		
	28	AXK728327G	AXK828125WG		
	32	AXK732327G	AXK832125WG		
	40	AXK740327G	AXK840125WG		
	50	AXK750327G	AXK850125WG		
	60	AXK760327G	AXK860125WG		
	80	AXK780327G	AXK880125WG		
3.0 mm	20	AXK720327G	AXK820225WG	3,000 pieces	6,000 pieces
	36	AXK736327G	AXK836225WG		
	40	AXK740327G	AXK840225WG		
	50	AXK750327G	AXK850225WG		
	60	AXK760327G	AXK860225WG		
	80	AXK780327G	AXK880225WG		
3.5 mm	20	AXK720427G	AXK820225WG	Socket: 2,000 pieces Header: 3,000 pieces	Socket: 4,000 pieces Header: 6,000 pieces
	30	AXK730427G	AXK830225WG		
	40	AXK740427G	AXK840225WG		
	50	AXK750427G	AXK850225WG		
	60	AXK760427G	AXK860225WG		
	70	AXK770427G	AXK870225WG		
	80	AXK780427G	AXK880225WG		
4.0 mm	34	AXK734527G	AXK834225WG	Socket: 2,000 pieces Header: 3,000 pieces	Socket: 4,000 pieces Header: 6,000 pieces
	42	AXK742527G	AXK842225WG		
	50	AXK750527G	AXK850225WG		
	80	AXK780527G	AXK880225WG		

- Notes: 1. Regarding ordering units; During production: Please make orders in 1-reel units.
 Samples for mounting confirmation: Available in units of 50 pieces. Please consult us. (See "Regarding sample orders to confirm proper mounting" on page 19.)
 Samples: Small lot orders are possible.
- The above part numbers are for connectors without positioning bosses, which are standard. When ordering connectors with positioning bosses, please contact our sales office.
 - "W" indicates a product with V notch and post edge horseshoe bend. ("Post edge horseshoe bend" refers to a construction that makes it difficult for the header post edge to deform when the connector is inserted and removed at an angle.)
 - Previous V notch types ("Y" in 10 th place of the header part number) and the current V notch + post edge horseshoe bend types ("W" in the 10 th place of the header part number) are compatible for mating.
 - Different number of contacts are available on-demand production only. Please contact us for more details.

AXK7, 8

SPECIFICATIONS

1. Characteristics

	Item	Specifications	Conditions
Electrical characteristics	Rated current	0.3A/contact (Max. 5 A at total contacts)	
	Rated voltage	60V AC/DC	
	Breakdown voltage	150V AC for 1 min.	Detection current: 1mA
	Insulation resistance	Min. 1,000M Ω (initial)	Using 250V DC megger (applied for 1 min.)
	Contact resistance	Max. 70m Ω	Based on the contact resistance measurement method specified by JIS C 5402.
Mechanical characteristics	Composite insertion force	Max. 0.981N {100gf}/contacts \times contacts (initial)	
	Composite removal force	Min. 0.0588N {6gf}/contacts \times contacts (Mated height 1.5 mm, without removal and soldering terminal) Min. 0.118N {12gf}/contacts \times contacts (Mated height 1.5 mm, except without removal and soldering terminal)	
	Post holding force	Min. 0.981N {100gf}/contacts	Measuring the maximum force. As the contact is axially pull out.
Environmental characteristics	Ambient temperature	-55°C to +85°C	No freezing at low temperatures
	Soldering heat resistance	Max. peak temperature of 260°C (on the surface of the PC board around the connector terminals)	Infrared reflow soldering
		300°C within 5 sec. 350°C within 3 sec.	Soldering iron
	Thermal shock resistance (header and socket mated)	5 cycles, insulation resistance min. 100M Ω , contact resistance max. 70m Ω	Sequence 1. -55 \pm 3°C, 30 minutes 2. ~, Max. 5 minutes 3. 85 \pm 3°C, 30 minutes 4. ~, Max. 5 minutes
	Humidity resistance (header and socket mated)	120 hours, insulation resistance min. 100M Ω , contact resistance max. 70m Ω	Bath temperature 40 \pm 2°C, humidity 90 to 95% R.H.
	Saltwater spray resistance (header and socket mated)	24 hours, insulation resistance min. 100M Ω , contact resistance max. 70m Ω	Bath temperature 35 \pm 2°C, saltwater concentration 5 \pm 1%
H ₂ S resistance (header and socket mated)	48 hours, contact resistance max. 70m Ω	Bath temperature 40 \pm 2°C, gas concentration 3 \pm 1 ppm, humidity 75 to 80% R.H.	
Lifetime characteristics	Insertion and removal life	50 times	Repeated insertion and removal speed of max. 200 times/hours
Unit weight		Mated height 1.5mm, 20 contacts; Socket: 0.04g Header: 0.02g	

2. Material and surface treatment

Part name	Material	Surface treatment
Molded portion	LCP resin (UL94V-0)	—
Contact and Post	Copper alloy	Contact portion: Ni plating on base, Au plating on surface Terminal portion: Ni plating on base, Au plating on surface (Except for thick of terminal) However, upper terminal of Ni barrier production: Exposed over Ni The area adjacent to the terminal of the sockets on models with Ni barrier is exposed to Ni on base.
Soldering terminal portion	Copper alloy	Ni plating on base, Sn plating on surface (Except for front terminal)

DIMENSIONS (Unit: mm)

The CAD data of the products with a **CAD Data** mark can be downloaded from: <http://panasonic-electric-works.net/ac>

1. Without Soldering Terminal

Socket (Mated height: 1.5 mm, 2.0 mm, 2.5 mm, 3.0 mm, 3.5 mm and 4.0 mm)

CAD Data

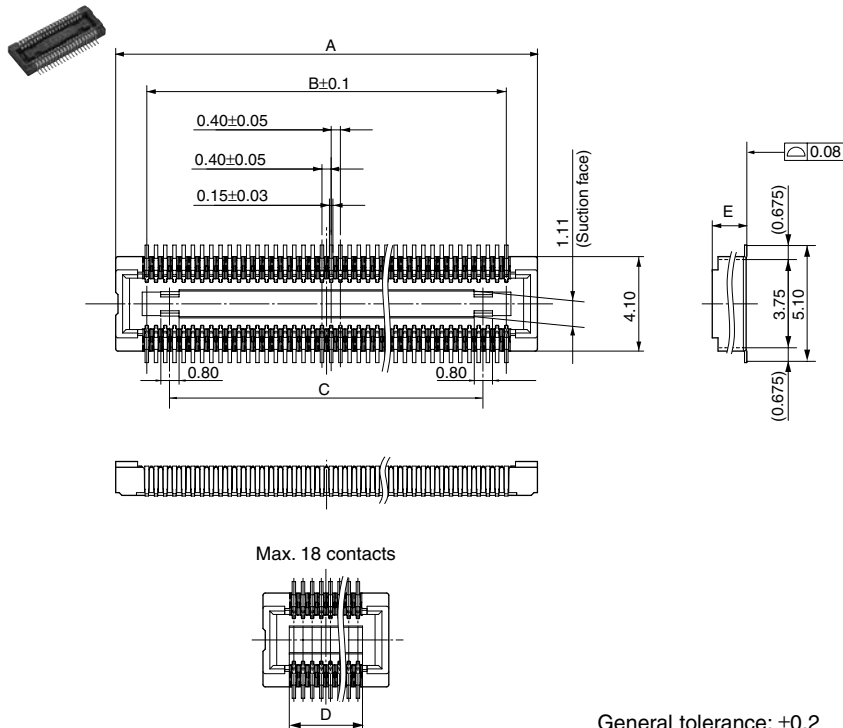

Dimension table (mm)

Number of contacts/ dimension	A	B	C	D
14	5.1	2.4	—	2.8
16	5.5	2.8	—	3.2
20	6.3	3.6	1.6	—
22	6.7	4.0	2.0	—
24	7.1	4.4	2.4	—
26	7.5	4.8	2.8	—
28	7.9	5.2	3.2	—
30	8.3	5.6	3.6	—
34	9.1	6.4	4.4	—
36	9.5	6.8	4.8	—
38	9.9	7.2	5.2	—
40	10.3	7.6	5.6	—
42	10.7	8.0	6.0	—
44	11.1	8.4	6.4	—
50	12.3	9.6	7.6	—
54	13.1	10.4	8.4	—
60	14.3	11.6	9.6	—
64	15.1	12.4	10.4	—
70	16.3	13.6	11.6	—
80	18.3	15.6	13.6	—
90	20.3	17.6	15.6	—
100	22.3	19.6	17.6	—

Mated height/dimension	E
1.5mm	1.50
2.0mm	1.92
2.5mm, 3.0mm	2.42
3.5mm	2.92
4.0mm	3.42

Header (Mated height: 1.5 mm, 2.0 mm, 2.5 mm, 3.0 mm, 3.5 mm and 4.0 mm)

CAD Data

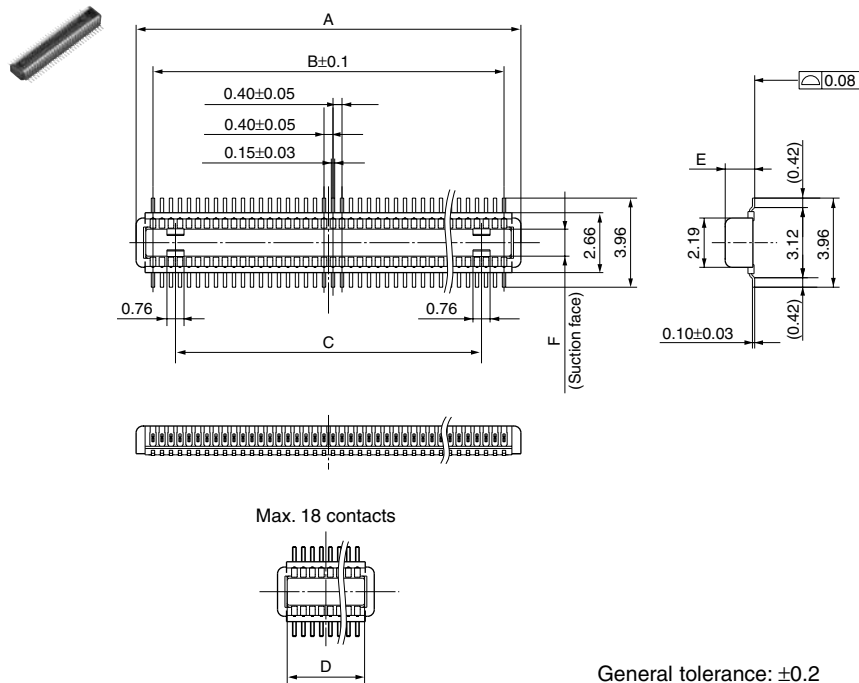

Dimension table (mm)

Number of contacts/ dimension	A	B	C	D
14	3.9	2.4	—	3.04
16	4.3	2.8	—	3.44
20	5.1	3.6	1.6	—
22	5.5	4.0	2.0	—
24	5.9	4.4	2.4	—
26	6.3	4.8	2.8	—
28	6.7	5.2	3.2	—
30	7.1	5.6	3.6	—
34	7.9	6.4	4.4	—
36	8.3	6.8	4.8	—
38	8.7	7.2	5.2	—
40	9.1	7.6	5.6	—
42	9.5	8.0	6.0	—
44	9.9	8.4	6.4	—
50	11.1	9.6	7.6	—
54	11.9	10.4	8.4	—
60	13.1	11.6	9.6	—
64	13.9	12.4	10.4	—
70	15.1	13.6	11.6	—
80	17.1	15.6	13.6	—
90	19.1	17.6	15.6	—
100	21.1	19.6	17.6	—

Mated height/dimension	E	F
1.5mm, 2.0mm, 2.5mm	1.31	1.20
3.0mm, 3.5mm, 4.0mm	2.26	1.26

Socket and Header are mated

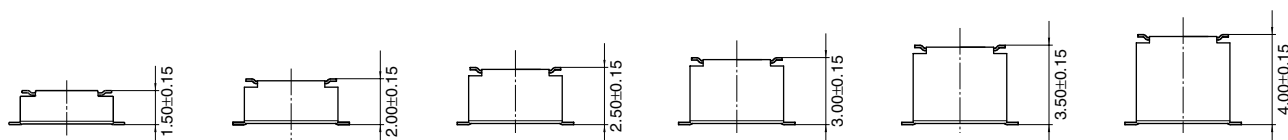

AXK7, 8

2. With Soldering Terminal

Socket (Mated height: 1.5mm, 2.0mm, 2.5mm, 3.0mm, 3.5mm and 4.0mm)

CAD Data

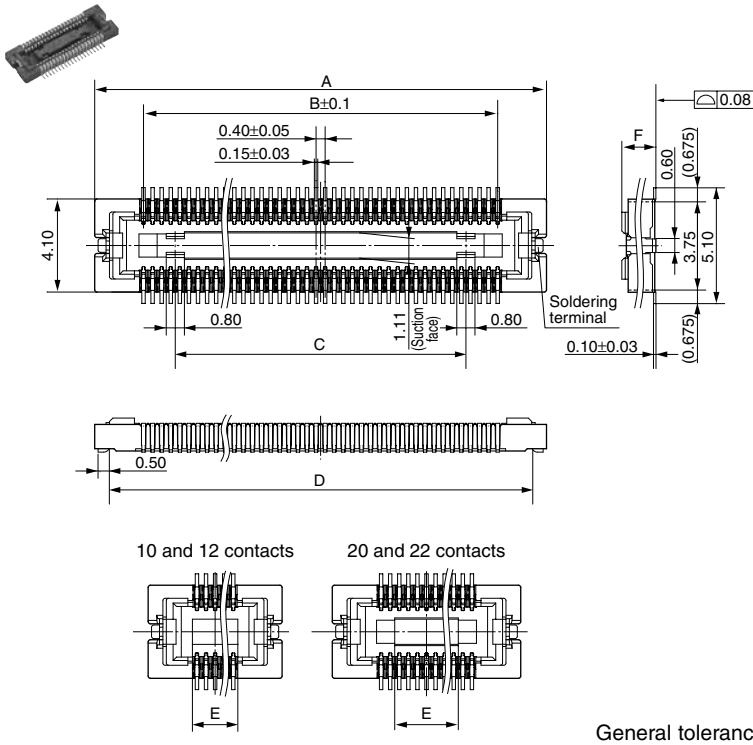

Dimension table (mm)

Number of contacts/ dimension	A	B	C	D	E
10	5.90	1.60	—	4.60	2.00
12	6.30	2.00	—	5.00	2.40
20	7.90	3.60	—	6.60	2.40
22	8.30	4.00	—	7.00	2.80
24	8.70	4.40	1.60	7.40	—
28	9.50	5.20	2.40	8.20	—
30	9.90	5.60	2.80	8.60	—
32	10.30	6.00	3.20	9.00	—
34	10.70	6.40	3.60	9.40	—
36	11.10	6.80	4.00	9.40	—
40	11.90	7.60	4.80	10.60	—
42	12.30	8.00	5.20	11.00	—
44	12.70	8.40	5.60	11.40	—
46	13.10	8.80	6.00	11.80	—
50	13.90	9.60	6.80	12.60	—
60	15.90	11.60	8.80	14.60	—
70	17.90	13.60	10.80	16.60	—
80	19.90	15.60	12.80	18.60	—
90	21.90	17.60	14.80	20.60	—
100	23.90	19.60	16.80	22.60	—

Mated height/dimension	F
1.5mm	1.50
2.0mm	1.92
2.5mm, 3.0mm	2.42
3.5mm	2.92
4.0mm	3.42

Header (Mated height: 1.5mm, 2.0mm, 2.5mm, 3.0mm, 3.5mm and 4.0mm)

CAD Data

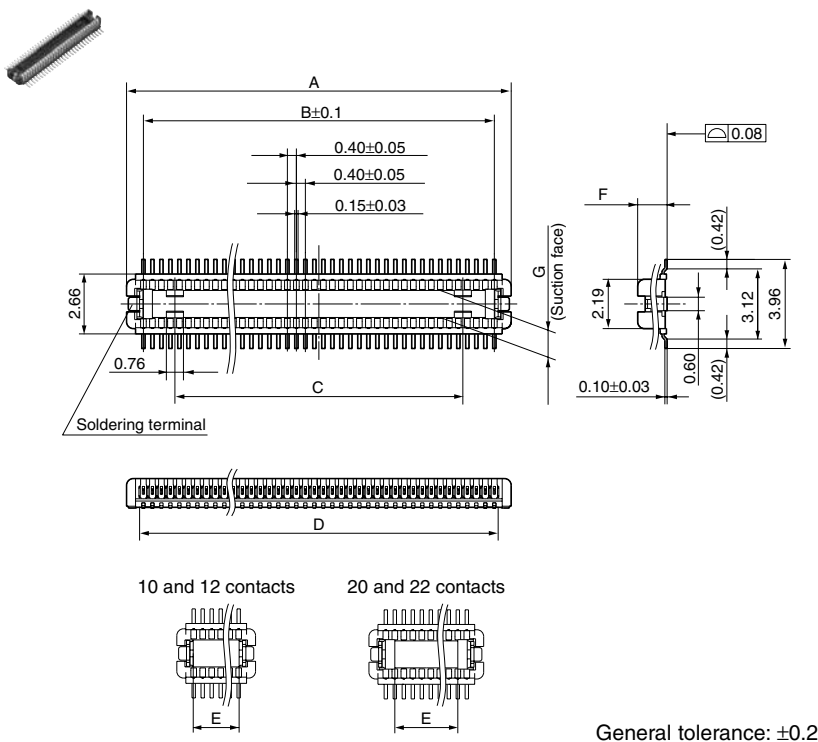

Dimension table (mm)

Number of contacts/ dimension	A	B	C	D	E
10	3.10	1.60	—	1.94	1.64
12	3.50	2.00	—	2.34	2.04
20	5.10	3.60	—	3.94	2.80
22	5.50	4.00	—	4.34	3.20
24	5.90	4.40	1.60	4.74	—
28	6.70	5.20	2.40	5.54	—
30	7.10	5.60	2.80	5.94	—
32	7.50	6.00	3.20	6.34	—
34	7.90	6.40	3.60	6.74	—
36	8.30	6.80	4.00	7.14	—
40	9.10	7.60	4.80	7.94	—
42	9.50	8.00	5.20	8.34	—
44	9.90	8.40	5.60	8.74	—
46	10.30	8.80	6.00	9.14	—
50	11.10	9.60	6.80	9.94	—
60	13.10	11.60	8.80	11.94	—
70	15.10	13.60	10.80	13.94	—
80	17.10	15.60	12.80	15.94	—
90	19.10	17.60	14.80	17.94	—
100	21.10	19.60	16.80	19.94	—

Mated height/dimension	F	G
1.5mm, 2.0mm, 2.5mm	1.31	1.20
3.0mm, 3.5mm, 4.0mm	2.26	1.26

Socket and Header are mated.

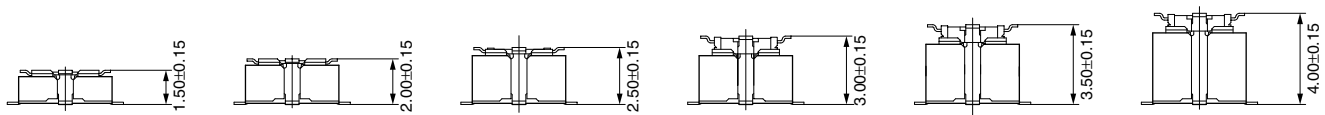

EMBOSSED TAPE DIMENSIONS (unit: mm, Common for respective contact type, socket and header)

• Tape dimensions (Conforming to JIS C 0806-1990.

• Plastic reel dimensions (Conforming to EIAJ ET-7200B)

However, some tapes have mounting hole pitches that do not comply with the standard.)

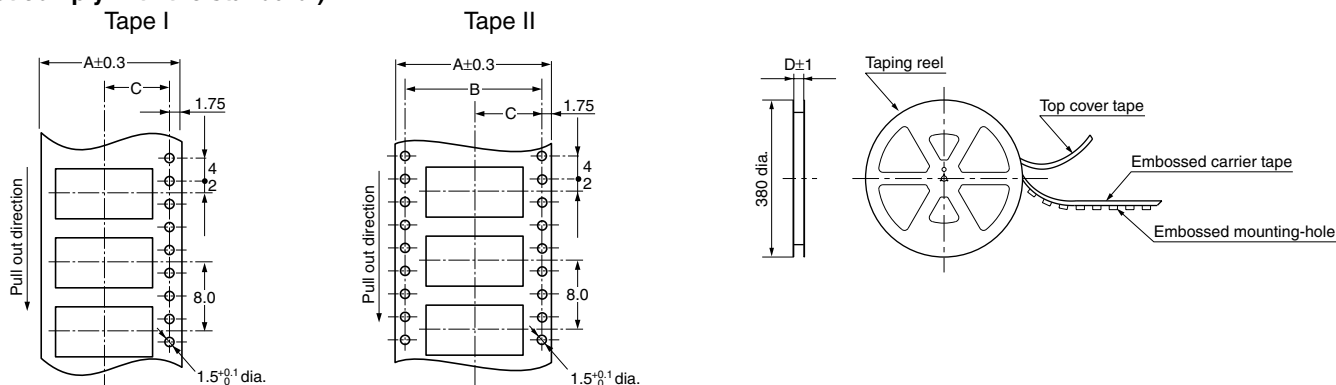

Dimension table (mm)

1. Without Soldering Terminal

Mated height	Number of contacts	Type of taping	A	B	C	D	Quantity per reel
Common for socket and header: 1.5 mm, 2.0 mm and 2.5 mm	Max. 18	Tape I	16.0	—	7.5	17.4	3,000
	20 to 70	Tape I	24.0	—	11.5	25.4	3,000
	80 to 100	Tape II	32.0	28.4	14.2	33.4	3,000

2. With Soldering Terminal

Mated height	Number of contacts		Type of taping	A	B	C	D	Quantity per reel
	Socket	Header						
Common for socket and header: 1.5 mm, 2.0 mm, 2.5 mm, and 3.0 mm Header: 3.5mm and 4.0 mm	Max. 18	Max. 18	Tape I	16.0	—	7.5	17.4	3,000
	20 to 60	20 to 70	Tape I	24.0	—	11.5	25.4	3,000
	70 to 90	80 to 100	Tape II	32.0	28.4	14.2	33.4	3,000
	100	—	Tape II	44.0	40.4	20.2	45.4	3,000
Socket: 3.5mm and 4.0 mm	Max. 18		Tape I	16.0	—	7.5	17.4	2,000
	20 to 60		Tape I	24.0	—	11.5	25.4	2,000
	70 to 90		Tape II	32.0	28.4	14.2	33.4	2,000
	100		Tape II	44.0	40.4	20.2	45.4	2,000

3. Connector orientation with respect to direction of progress of embossed tape

1) Without soldering terminal

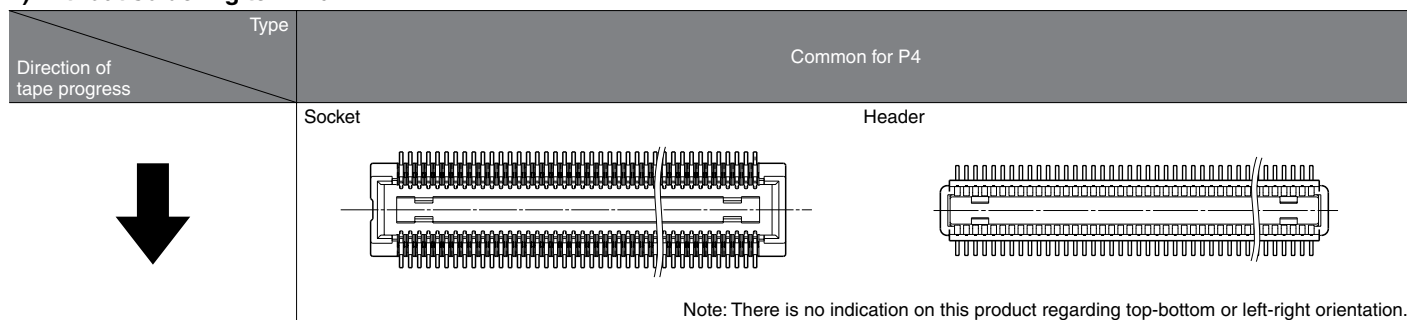

2) With soldering terminal

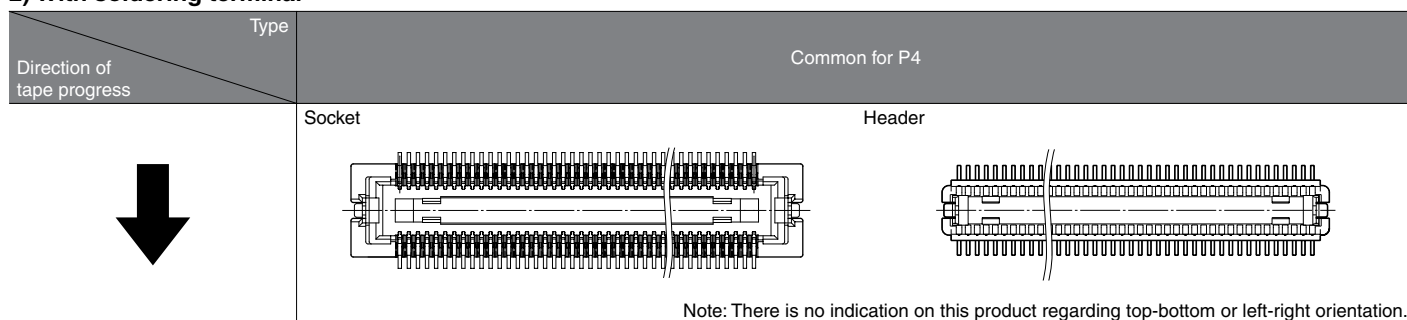



Socket



Header

Compliance with RoHS Directive

TABLE OF PRODUCT TYPES

☆: Available for sale

Product name	P4 for inspection without soldering terminal	P4 for inspection with soldering terminal
10		☆
12		☆
14	☆	
16	☆	
20	☆	☆
22	☆	☆
24	☆	☆
26	☆	
28	☆	☆
30	☆	☆
34	☆	☆
36	☆	
40	☆	☆
42	☆	
44	☆	☆
46		☆
50	☆	☆
54	☆	
60	☆	☆
70	☆	
80	☆	☆
90	☆	☆
100	☆	☆

Number of contacts

Notes:

1. You can use with each mated height in common.
2. Please inquire about numbers of contacts other than those given above.
3. Please inquire with us regarding delivery times.
4. Please keep the minimum unit for ordering no less than 50 pieces per lot.
5. Please inquire for further information.

FEATURES

1. 3,000 insertion and removals (when as recommended)

From the 50 insertion and removals of standard type, up to 3,000 insertion and removals (with recommended insertion and removal) are possible for use in inspection.

Ideal for inspection of module units and inspection during the device assembly process

2. Same external dimensions and foot pattern as standard type.

Since shape is the same as standard type, inspection is possible without interfering with devices in the vicinity of standard connectors.

3. Improved mating

Insertion and removal have become easier due to a reduction in the mating retention force required by the simple locking structure and also in the amount of force needed for insertion and removal. (We cannot warrant anything regarding mating retention.)

PRODUCT TYPES

Specifications			Part No.	Specifications			Part No.
Socket	With soldering terminal	Without positioning bosses	AXK7E**26G	Header	With soldering terminal	Without positioning bosses	AXK8E**26WG
	Without soldering terminal	Without positioning bosses	AXK7E**46G		Without soldering terminal	Without positioning bosses	AXK8E**46WG

Notes: 1. When placing an order, substitute the "*" (asterisk) in the above part number with the number of contacts for the required connector.

2. The above part numbers are for connectors without positioning bosses, which are standard. When ordering connectors with positioning bosses, please contact our sales office.

NOTES

1. As shown below, excess force during insertion may result in damage to the connector or removal of the solder. Please be careful. Also, to prevent connector damage please confirm the correct position before mating connectors.

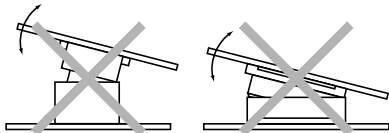

2. Keep the PC board warp no more than 0.03 mm in relation to the overall length of the connector.

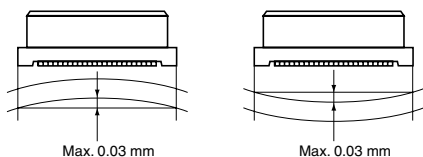

3. PC Boards and Recommended Metal Mask Patterns

Connectors are mounted with high density, with a pitch interval of 0.4 to 0.5 mm.

In order to reduce solder bridge and other issues make sure the proper levels of solder are used.

The figures to the right are recommended metal mask patterns.

Please use them as a reference.

1) Without soldering terminal

Socket

Recommended PC board pattern (TOP VIEW)

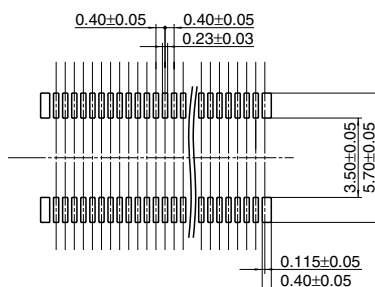

Recommended metal mask pattern

Metal mask thickness: Here, 150 μm
(Opening area ratio: 40 %)

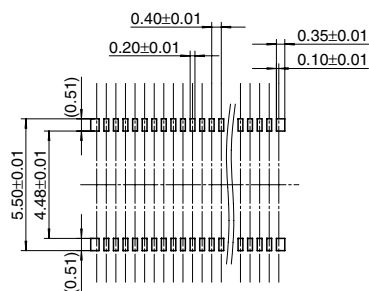

Recommended metal mask pattern

Metal mask thickness: Here, 120 μm
(Opening area ratio: 50 %)

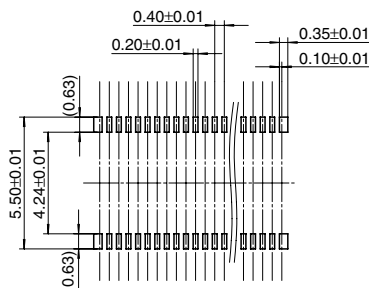

Header

Recommended PC board pattern (TOP VIEW)

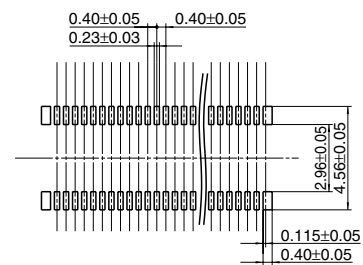

Recommended metal mask pattern

Metal mask thickness: Here, 150 μm
(Opening area ratio: 32 %)

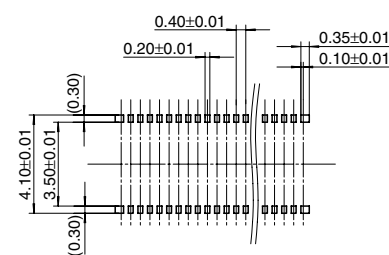

Recommended metal mask pattern

Metal mask thickness: Here, 120 μm
(Opening area ratio: 40 %)

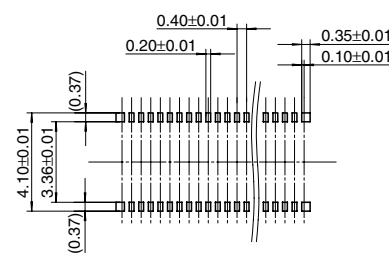

AXK7, 8

2) With soldering terminal

Socket

Recommended PC board pattern (TOP VIEW)

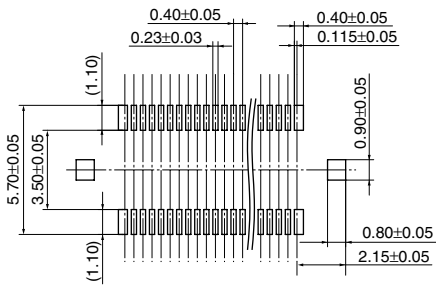

Recommended metal mask pattern

Metal mask thickness: Here, 150 μ m
(Terminal portion opening area ratio: 40 %)
(Metal portion opening area ratio: 65 %)

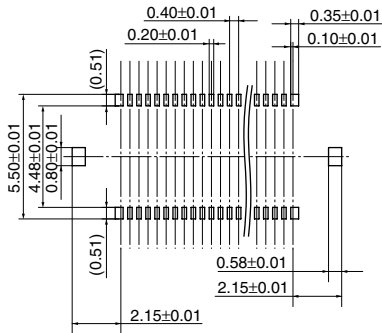

Recommended metal mask pattern

Metal mask thickness: Here, 120 μ m
(Terminal portion opening area ratio: 50 %)
(Metal portion opening area ratio: 80 %)

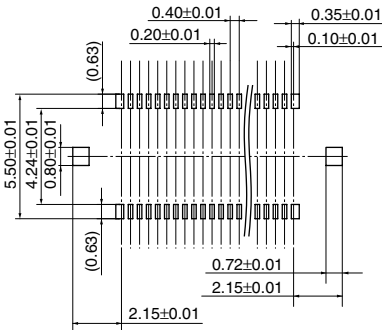

Header

Recommended PC board pattern (TOP VIEW)

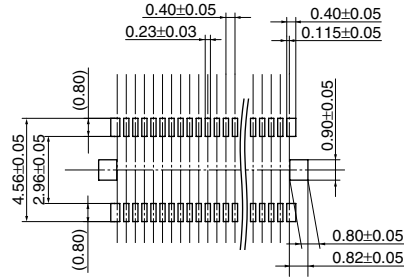

Recommended metal mask pattern

Metal mask thickness: Here, 150 μ m
(Terminal portion opening area ratio: 32 %)
(Metal portion opening area ratio: 65 %)

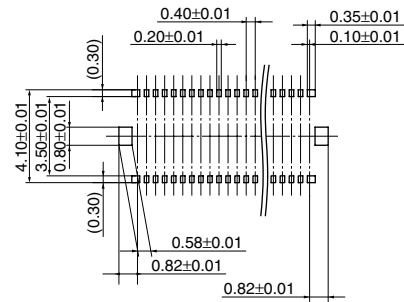

Recommended metal mask pattern

Metal mask thickness: Here, 120 μ m
(Terminal portion opening area ratio: 40 %)
(Metal portion opening area ratio: 80 %)

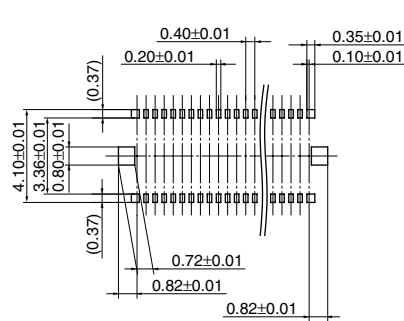

For other details, please verify with the product specification sheets.

Mouser Electronics

Authorized Distributor

Click to View Pricing, Inventory, Delivery & Lifecycle Information:

Panasonic:

[AXK724547G](#) [AXK726247G](#) [AXK730427G](#) [AXK730447G](#) [AXK760247G](#) [AXK830125WG](#) [AXK830225WG](#)
[AXK700127G](#) [AXK710127G](#) [AXK722127G](#) [AXK726137G](#) [AXK726147G](#) [AXK740127G](#) [AXK750327G](#) [AXK760327G](#)
[AXK7E8016G](#) [AXK800125WG](#) [AXK810125WG](#) [AXK820125WG](#) [AXK822125WG](#) [AXK826135WG](#) [AXK826145WG](#)
[AXK840125WG](#) [AXK850225WG](#) [AXK860225WG](#) [AXK8E8016WG](#) [AXK700117G](#) [AXK700137G](#) [AXK700147G](#)
[AXK700237G](#) [AXK700247G](#) [AXK700337G](#) [AXK700347G](#) [AXK710117G](#) [AXK714137G](#) [AXK714147G](#) [AXK714237G](#)
[AXK714247G](#) [AXK714337G](#) [AXK714347G](#) [AXK716137G](#) [AXK716147G](#) [AXK720117G](#) [AXK720137G](#)
[AXK720147G](#) [AXK720237G](#) [AXK720247G](#) [AXK720317G](#) [AXK720337G](#) [AXK720347G](#) [AXK720417G](#) [AXK722117G](#)
[AXK722137G](#) [AXK722147G](#) [AXK724137G](#) [AXK724147G](#) [AXK724217G](#) [AXK724237G](#) [AXK724247G](#)
[AXK724337G](#) [AXK724347G](#) [AXK728117G](#) [AXK728137G](#) [AXK728147G](#) [AXK730117G](#) [AXK730137G](#) [AXK730147G](#)
[AXK730237G](#) [AXK730247G](#) [AXK730337G](#) [AXK730347G](#) [AXK732317G](#) [AXK734117G](#) [AXK734137G](#)
[AXK734147G](#) [AXK734237G](#) [AXK734247G](#) [AXK734517G](#) [AXK734527G](#) [AXK736137G](#) [AXK736147G](#) [AXK740117G](#)
[AXK740137G](#) [AXK740147G](#) [AXK740237G](#) [AXK740247G](#) [AXK740317G](#) [AXK740337G](#) [AXK740347G](#)
[AXK744117G](#) [AXK744137G](#) [AXK744147G](#) [AXK744337G](#) [AXK744347G](#) [AXK746117G](#) [AXK750117G](#) [AXK750137G](#)
[AXK750147G](#) [AXK750237G](#) [AXK750247G](#)