Low Noise 150 mA LDO Regulator

No. EA-258-180621

OUTLINE

The RP112x is a voltage regulator (LDO) with high output voltage accuracy, low-supply current, low On-resistance transistor, low noise output voltage and high ripple rejection. Each IC is composed of the followings: a voltage reference unit, an error amplifier, a resistor-net for output voltage setting, a current limit circuit, and a chip enable circuit.

The RP112x features ultra-low noise and its Ripple Rejection is as low as 80 dB at $f = 1$ kHz, 75 dB at $f = 10$ kHz and 65 dB at $f = 100$ kHz. The Output Noise is also as low as Typ. $10 \mu\text{Vrms}$. It is kept the low level at any Output Voltage. RP112x is suitable for the power source for the portable music player and RF module that demands for higher level of noise reduction. SOT-23-5 and SC-88A packages, a 1-mm square DFN(PLP)1010-4 package are available.

FEATURES

- Supply Current Typ. $75 \mu\text{A}$
- Standby Current Typ. $0.1 \mu\text{A}$
- Dropout Voltage Typ. 0.20 V ($I_{\text{OUT}} = 150 \text{ mA}$, $V_{\text{OUT}} = 2.8 \text{ V}$)
- Ripple Rejection Typ. 80 dB ($f = 1 \text{ kHz}$)
Typ. 75 dB ($f = 10 \text{ kHz}$)
Typ. 65 dB ($f = 100 \text{ kHz}$)
- Output Voltage Accuracy $\pm 1.0\%$
- Output Voltage Temperature Coefficient Typ. $\pm 30 \text{ ppm}/^\circ\text{C}$
- Line Regulation Typ. $0.02\%/V$
- Packages DFN(PLP)1010-4, SC-88A, SOT-23-5
- Input Voltage Range 2.0 V to 5.25 V
- Output Voltage Range 1.2 V to 4.8 V (0.1 V step)
- Short Current Limit Typ. 40 mA
- Built-in Foldback Protection Circuit
- Output Noise Typ. $10 \mu\text{Vrms}$
- Ceramic capacitors are recommended to be used with this IC $1.0 \mu\text{F}$ or more

APPLICATIONS

- Power source for portable communication equipment.
- Power source for electrical appliances such as cameras, VCRs and camcorders.
- Power source for battery-powered equipments.
- Power source for electrical home appliances.
- Power source for the portable music player
- Power source for RF module

RP112x

No. EA-258-180621

SELECTION GUIDE

The output voltage, auto-discharge function⁽¹⁾, package for the ICs can be selected at the user's request.

Selection Guide

Product Name	Package	Quantity per Reel	Pb Free	Halogen Free
RP112Kxx1*-TR	DFN(PLP)1010-4	10,000 pcs	Yes	Yes
RP112Qxx2*-TR-FE	SC-88A	3,000 pcs	Yes	Yes
RP112Nxx1*-TR-FE	SOT-23-5	3,000 pcs	Yes	Yes

xx: Set output voltage (V_{SET}) is selectable from 1.2 V to 4.8 V in 0.1 V step.

The second decimal point of the voltage is described as below.

1.25 V: RP112x12x*5

1.85 V: RP112x18x*5

2.85 V: RP112x28x*5

*: Selections of CE pin polarity and Auto-discharge function are as shown below:

(B) CE pin polarity: "H" active, Auto-discharge function: No

(D) CE pin polarity: "H" active, Auto-discharge function: Yes

BLOCK DIAGRAMS

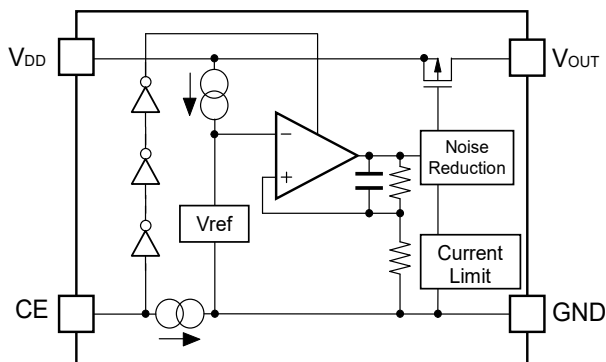

RP112xxxxB Block Diagram

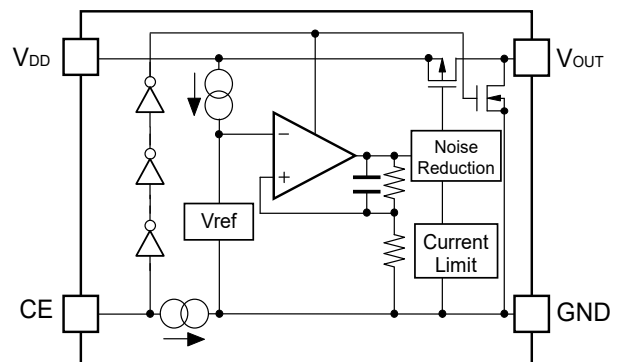

RP112xxxxD Block Diagram

⁽¹⁾ Auto-discharge function quickly lowers the output voltage to 0 V by releasing the electrical charge in the external capacitor when the chip enable signal is switched from the active mode to the standby mode.

PIN DESCRIPTIONS

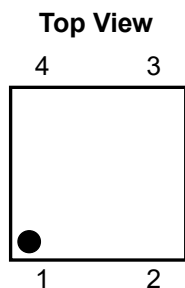

DFN(PLP)1010-4 Pin Configuration

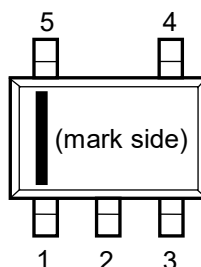
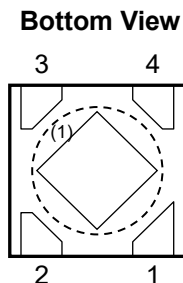

SC-88A Pin Configuration

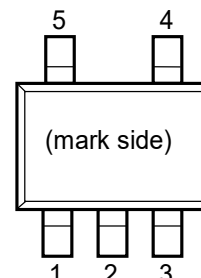

SOT-23-5 Pin Configuration

DFN(PLP)1010-4 Pin Description

Pin No.	Symbol	Description
1	V _{OUT}	Output Pin
2	GND	Ground Pin
3	CE	Chip Enable Pin ("H" Active)
4	V _{DD}	Input Pin

SC-88A Pin Description

Pin No	Symbol	Pin Description
1	V _{DD}	Input Pin
2	GND	Ground Pin
3	CE	Chip Enable Pin ("H" Active)
4	NC	No Connection
5	V _{OUT}	Output Pin

SOT-23-5 Pin Description

Pin No	Symbol	Pin Description
1	V _{DD}	Input Pin
2	GND	Ground Pin
3	CE	Chip Enable Pin ("H" Active)
4	NC	No Connection
5	V _{OUT}	Output Pin

⁽¹⁾ Tab is GND level (They are connected to the reverse side of this IC). The tab is better to be connected to the GND, but leaving it open is also acceptable.

RP112x

No. EA-258-180621

ABSOLUTE MAXIMUM RATINGS

Absolute Maximum Ratings

Symbol	Item		Rating	Unit	
V _{IN}	Input Voltage		6.0	V	
V _{CE}	Input Voltage (CE Pin)		6.0	V	
V _{OUT}	Output Voltage		-0.3 to V _{IN} + 0.3	V	
I _{OUT}	Output Current		180	mA	
P _D	Power Dissipation ⁽¹⁾	(DFN(PLP)1010-4)	JEDEC STD. 51-7 Test Land Pattern	800	mW
		SC-88A	Standard Test Land Pattern	380	
		SOT-23-5	JEDEC STD. 51-7 Test Land Pattern	660	
T _j	Junction Temperature Range		-40 to 125	°C	
T _{stg}	Storage Temperature Range		-55 to 125	°C	

ABSOLUTE MAXIMUM RATINGS

Electronic and mechanical stress momentarily exceeded absolute maximum ratings may cause the permanent damages and may degrade the life time and safety for both device and system using the device in the field. The functional operation at or over these absolute maximum ratings is not assured.

RECOMMENDED OPERATING CONDITIONS

Recommended Operating Conditions

Symbol	Item	Rating	Unit
V _{IN}	Input Voltage	2.0 to 5.25	V
T _a	Operating Temperature	-40 to 85	°C

RECOMMENDED OPERATING CONDITIONS

All of electronic equipment should be designed that the mounted semiconductor devices operate within the recommended operating conditions. The semiconductor devices cannot operate normally over the recommended operating conditions, even if when they are used over such conditions by momentary electronic noise or surge. And the semiconductor devices may receive serious damage when they continue to operate over the recommended operating conditions.

⁽¹⁾ Refer to *POWEWR DISSIPATION* for detailed information.

ELECTRICAL CHARACTERISTICS

Unless otherwise noted, $V_{IN} = 5.25\text{ V}$ ($V_{OUT} \geq 4.1\text{ V}$), $V_{IN} = \text{Set } V_{OUT} + 1.0\text{ V}$ ($1.5\text{ V} < V_{OUT} < 4.1\text{ V}$), $V_{IN} = 2.5\text{ V}$ ($V_{OUT} \leq 1.5\text{ V}$), $I_{OUT} = 1\text{ mA}$, $C_{IN} = C_{OUT} = 1.0\text{ }\mu\text{F}$

The specifications surrounded by are guaranteed by design engineering at $-40^\circ\text{C} \leq T_a \leq 85^\circ\text{C}$.

RP112xxxxB/D Electrical Characteristics

($T_a = 25^\circ\text{C}$)

Symbol	Item	Conditions	Min.	Typ.	Max.	Unit	
V_{OUT}	Output Voltage	$T_a = 25^\circ\text{C}$	$V_{OUT} \geq 2.0\text{ V}$	x0.99		x1.01	V
			$V_{OUT} < 2.0\text{ V}$	-20		+20	mV
		$-40^\circ\text{C} \leq T_a \leq 85^\circ\text{C}$	$V_{OUT} \geq 2.0\text{ V}$	x0.985		x1.015	V
			$V_{OUT} < 2.0\text{ V}$	-30		+30	mV
I_{OUT}	Output Current		150			mA	
$\Delta V_{OUT}/\Delta I_{OUT}$	Load Regulation	$1\text{ mA} \leq I_{OUT} \leq 150\text{ mA}$	-14	0	14	mV	
V_{DIF}	Dropout Voltage	Refer to <i>Product-specific Electrical Characteristics</i>					
I_{SS}	Supply Current	$I_{OUT} = 0\text{ mA}$	$V_{OUT} \geq 4.1\text{ V}$		80	100	μA
			$V_{OUT} < 4.1\text{ V}$		75		
$I_{standby}$	Standby Current	$V_{CE} = 0\text{ V}$		0.1	1.0	μA	
$\Delta V_{OUT}/\Delta V_{IN}$	Line Regulation	$\text{Set } V_{OUT} + 0.3\text{ V} \leq V_{IN} \leq 5.25\text{ V}$	$V_{OUT} \geq 4.1\text{ V}$		0.02	0.10	%V
		$\text{Set } V_{OUT} + 0.5\text{ V} \leq V_{IN} \leq 5.0\text{ V}$	$1.7\text{ V} \leq V_{OUT} < 4.1\text{ V}$				
		$2.2\text{ V} \leq V_{IN} \leq 5.0\text{ V}$	$V_{OUT} < 1.7\text{ V}$				
RR	Ripple Rejection	Ripple 0.2 V _{p-p} , $I_{OUT} = 30\text{ mA}$, $V_{IN} = 5.25\text{ V}$ ($V_{OUT} \geq 4.1\text{ V}$), $V_{IN} = \text{Set } V_{OUT} + 1.0\text{ V}$ ($V_{OUT} < 4.1\text{ V}$)	$f = 1\text{ kHz}$		80		dB
			$f = 10\text{ kHz}$		75		
			$f = 100\text{ kHz}$		65		
V_{IN}	Input Voltage ⁽¹⁾		2.0		5.25	V	
$\Delta V_{OUT}/\Delta T_a$	Output Voltage Temperature Coefficient	$-40^\circ\text{C} \leq T_a \leq 85^\circ\text{C}$		± 30		ppm/ °C	
I_{SC}	Short Current Limit	$V_{OUT} = 0\text{ V}$		40		mA	
I_{PD}	CE Pull-down Current			0.3	0.6	μA	
V_{CEH}	CE Input Voltage "H"		1.0			V	
V_{CEL}	CE Input Voltage "L"				0.4	V	

All test categories were tested on the products under the pulse load condition ($T_j \approx T_a = 25^\circ\text{C}$) except Output Noise, Ripple Rejection, and Output Voltage Temperature Coefficient.

⁽¹⁾ The maximum input voltage (Electrical Characteristics) is 5.25 V. If, for any reason the maximum input voltage exceeds 5.25 V, it has to be no more than 5.5 V with 500 hrs of the total operating time.

RP112x

No. EA-258-180621

ELECTRICAL CHARACTERISTICS (continued)Unless otherwise noted, $V_{IN} = 5.25\text{ V}$ ($V_{OUT} \geq 4.1\text{ V}$), $V_{IN} = \text{Set } V_{OUT} + 1.0\text{ V}$ ($1.5\text{ V} < V_{OUT} < 4.1\text{ V}$), $V_{IN} = 2.5\text{ V}$ ($V_{OUT} \leq 1.5\text{ V}$), $I_{OUT} = 1\text{ mA}$, $C_{IN} = C_{OUT} = 1.0\text{ }\mu\text{F}$ The specifications surrounded by are guaranteed by design engineering at $-40^{\circ}\text{C} \leq T_a \leq 85^{\circ}\text{C}$.**RP112xxxxB/D Electrical Characteristics**

(Ta = 25°C)

Symbol	Item	Conditions	Min.	Typ.	Max.	Unit
en	Output Noise	BW = 10 Hz to 100 kHz, $I_{OUT} = 30\text{ mA}$		10		μVrms
R_{LOW}	Auto-discharge Nch Tr. ON Resistance (RP112xxxxD only)	$V_{IN} = 4.0\text{ V}$, $V_{CE} = 0\text{ V}$		60		Ω

All test categories were tested on the products under the pulse load condition ($T_j \approx T_a = 25^{\circ}\text{C}$) except Output Noise, Ripple Rejection, and Output Voltage Temperature Coefficient.

The specifications surrounded by are guaranteed by design engineering at $-40^{\circ}\text{C} \leq T_a \leq 85^{\circ}\text{C}$.

Product-specific Electrical Characteristics

Product Name	V _{OUT}						V _{DIF}	
	Ta = 25°C			-40°C ≤ Ta ≤ 85°C			Ta = 25°C	
	Min.	Typ.	Max.	Min.	Typ.	Max.	Typ.	Max.
RP112x12xx	1.180	1.20	1.220	1.170	1.20	1.230	0.39	0.80
RP112x12xx5	1.230	1.25	1.270	1.220	1.25	1.280	0.39	0.80
RP112x13xx	1.280	1.30	1.320	1.270	1.30	1.330	0.37	0.70
RP112x14xx	1.380	1.40	1.420	1.370	1.40	1.430	0.34	0.60
RP112x15xx	1.480	1.50	1.520	1.470	1.50	1.530	0.32	0.50
RP112x16xx	1.580	1.60	1.620	1.570	1.60	1.630	0.32	0.50
RP112x17xx	1.680	1.70	1.720	1.670	1.70	1.730	0.29	0.41
RP112x18xx	1.780	1.80	1.820	1.770	1.80	1.830	0.29	0.41
RP112x18xx5	1.830	1.85	1.870	1.820	1.85	1.880	0.29	0.41
RP112x19xx	1.880	1.90	1.920	1.870	1.90	1.930	0.29	0.41
RP112x20xx	1.980	2.00	2.020	1.970	2.00	2.030	0.25	0.36
RP112x21xx	2.079	2.10	2.121	2.069	2.10	2.132	0.25	0.36
RP112x22xx	2.178	2.20	2.222	2.167	2.20	2.233	0.25	0.36
RP112x23xx	2.277	2.30	2.323	2.266	2.30	2.335	0.25	0.36
RP112x24xx	2.376	2.40	2.424	2.364	2.40	2.436	0.25	0.36
RP112x25xx	2.475	2.50	2.525	2.463	2.50	2.538	0.22	0.31
RP112x26xx	2.574	2.60	2.626	2.561	2.60	2.639	0.22	0.31
RP112x27xx	2.673	2.70	2.727	2.660	2.70	2.741	0.22	0.31
RP112x28xx	2.772	2.80	2.828	2.758	2.80	2.842	0.20	0.28
RP112x28xx5	2.822	2.85	2.879	2.807	2.85	2.893	0.20	0.28
RP112x29xx	2.871	2.90	2.929	2.857	2.90	2.944	0.20	0.28
RP112x29xx5	2.921	2.95	2.980	2.906	2.95	2.994	0.20	0.28
RP112x30xx	2.970	3.00	3.030	2.955	3.00	3.045	0.20	0.28
RP112x31xx	3.069	3.10	3.131	3.054	3.10	3.147	0.20	0.28
RP112x31xx5	3.119	3.15	3.182	3.103	3.15	3.197	0.20	0.28
RP112x32xx	3.168	3.20	3.232	3.152	3.20	3.248	0.20	0.28
RP112x33xx	3.267	3.30	3.333	3.251	3.30	3.350	0.20	0.28
RP112x34xx	3.366	3.40	3.434	3.349	3.40	3.451	0.20	0.28
RP112x35xx	3.465	3.50	3.535	3.448	3.50	3.553	0.20	0.28
RP112x36xx	3.564	3.60	3.636	3.546	3.60	3.654	0.20	0.28
RP112x37xx	3.663	3.70	3.737	3.645	3.70	3.756	0.20	0.28
RP112x38xx	3.762	3.80	3.838	3.743	3.80	3.857	0.20	0.28
RP112x39xx	3.861	3.90	3.939	3.842	3.90	3.959	0.20	0.28
RP112x40xx	3.960	4.00	4.040	3.940	4.00	4.060	0.20	0.28
RP112x41xx	4.059	4.10	4.141	4.039	4.10	4.162	0.20	0.28
RP112x42xx	4.158	4.20	4.242	4.137	4.20	4.263	0.20	0.28
RP112x43xx	4.257	4.30	4.343	4.236	4.30	4.365	0.20	0.28
RP112x44xx	4.356	4.40	4.444	4.334	4.40	4.466	0.20	0.28
RP112x45xx	4.455	4.50	4.545	4.433	4.50	4.568	0.20	0.28
RP112x46xx	4.554	4.60	4.646	4.531	4.60	4.669	0.20	0.28
RP112x47xx	4.653	4.70	4.747	4.630	4.70	4.771	0.20	0.28
RP112x48xx	4.752	4.80	4.848	4.728	4.80	4.872	0.20	0.28

RP112x

No. EA-258-180621

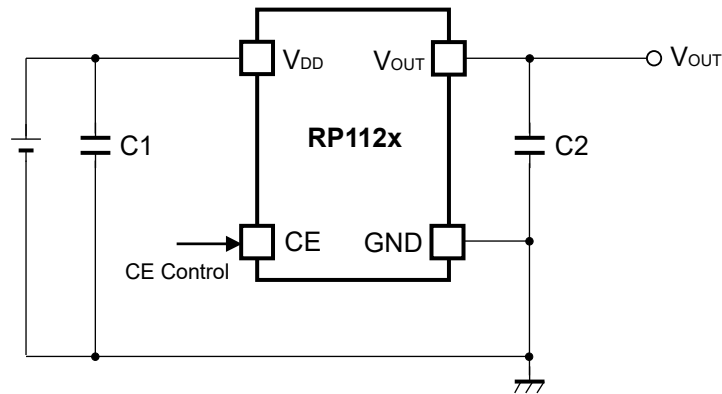
APPLICATION INFORMATION**TYPICAL APPLICATIONS****External Components**

Symbol	Description
C1 (C _{IN})	1.0 μ F, Ceramic Capacitor, GRM155B31A105KE15, MURATA
C2 (C _{OUT})	1.0 μ F, Ceramic Capacitor, GRM155B31A105KE15, MURATA

TECHNICAL NOTES**Phase Compensation**

In these ICs, phase compensation is made for securing stable operation even if the load current is varied. For this purpose, use a 1.0 μ F or more capacitor C2.

In case of using a tantalum capacitor, the output may be unstable due to inappropriate ESR. Therefore, the full range of operating conditions for the capacitor in the application should be considered.

PCB Layout

The high impedances of V_{DD} and GND could be a reason for the noise pickup and unstable operation. Therefore, it is imperative that the impedances of V_{DD} and GND be the lowest possible. Also, place a 1.0 μ F or more capacitor (C1) between V_{DD} pin and GND pin as close as possible to each other.

As for C2 output capacitor that is used for phase compensation, place it between V_{OUT} pin and GND as close as possible to each other (Refer to *TYPICAL APPLICATIONS*).

TYPICAL CHARACTERISTICS

Typical Characteristics are intended to be used as reference data; they are not guaranteed.

1) Output Voltage vs. Output Current (C1 = Ceramic 1.0 μ F, C2 = Ceramic 1.0 μ F, Ta = 25°C)

RP112x12xx

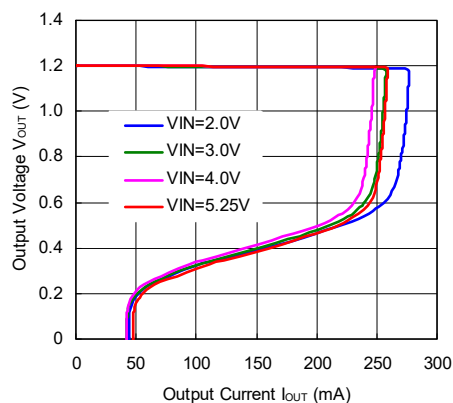

RP112x28xx

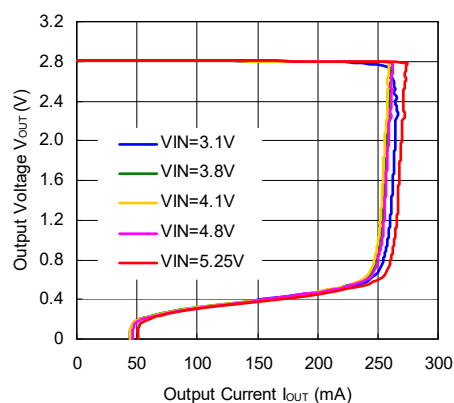

RP112x40xx

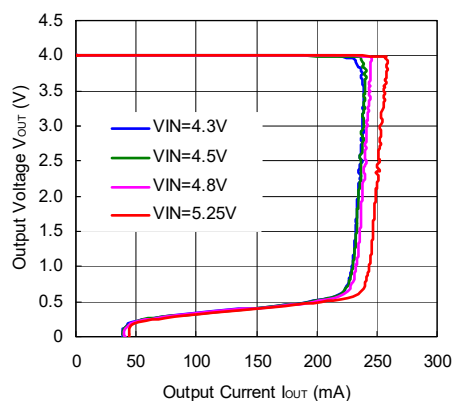

RP112x48xx

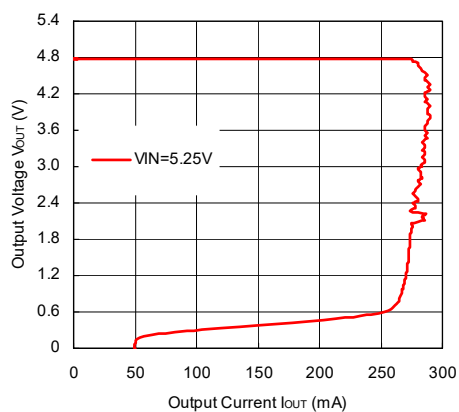

2) Output Voltage vs. Input Voltage (C1 = Ceramic 1.0 μ F, C2 = Ceramic 1.0 μ F, Ta = 25°C)

RP112x12xx

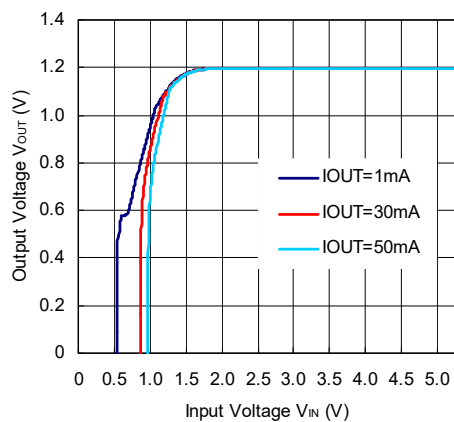

RP112x28xx

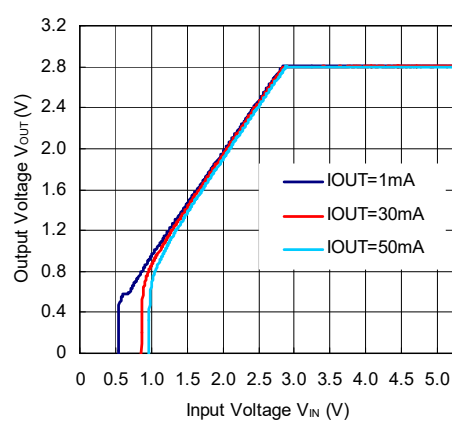

RP112x40xx

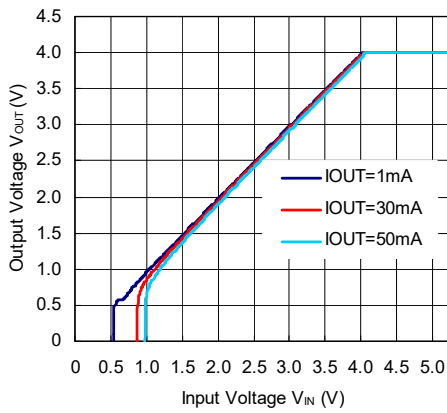

RP112x48xx

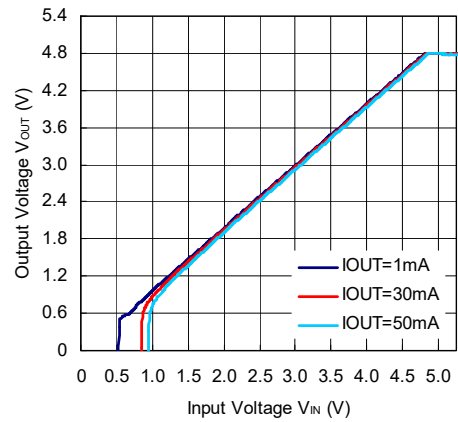

3) Supply Current vs. Input Voltage (C1 = Ceramic 1.0 μ F, C2 = Ceramic 1.0 μ F, Ta = 25°C)

RP112x12xx

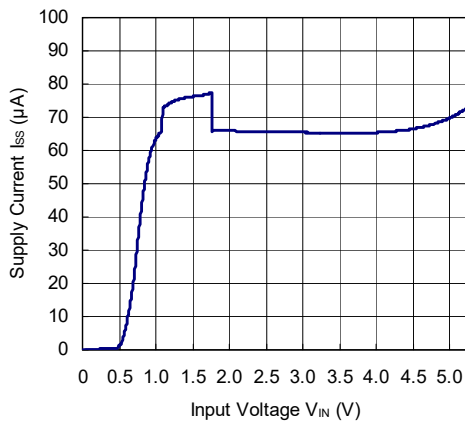

RP112x28xx

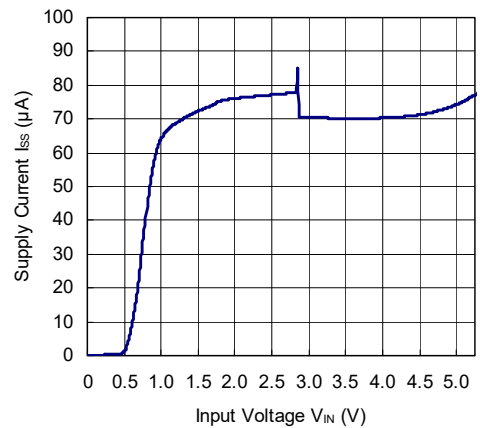

RP112x40xx

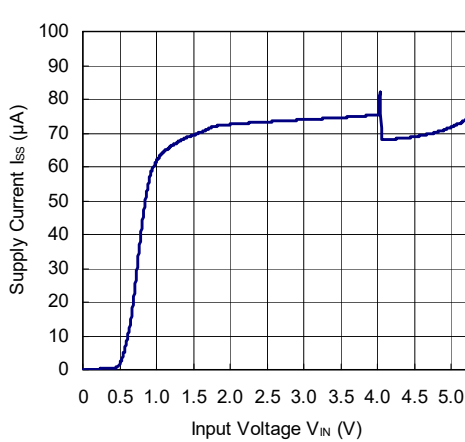

RP112x48xx

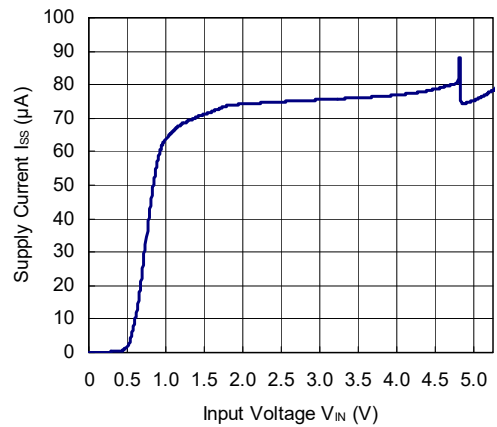

4) Output Voltage vs. Temperature (C1 = Ceramic 1.0 μ F, C2 = Ceramic 1.0 μ F, $I_{OUT} = 1$ mA)

RP112x12xx

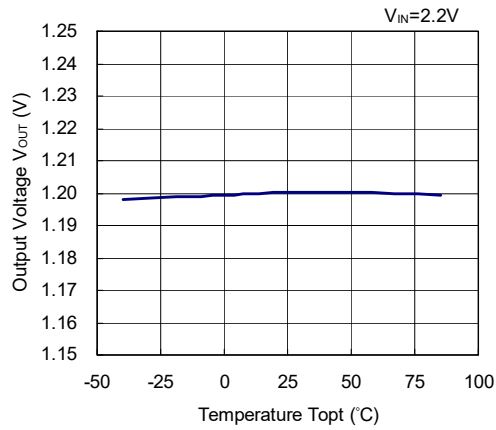

RP112x28xx

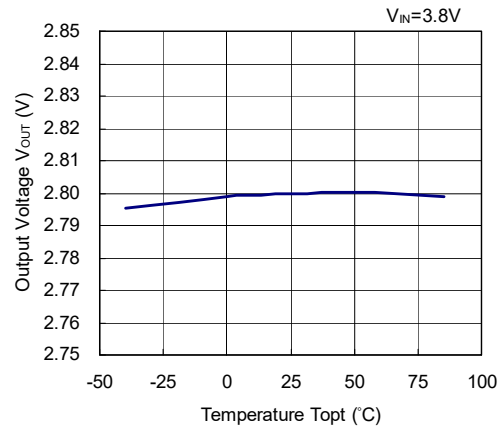

RP112x40xx

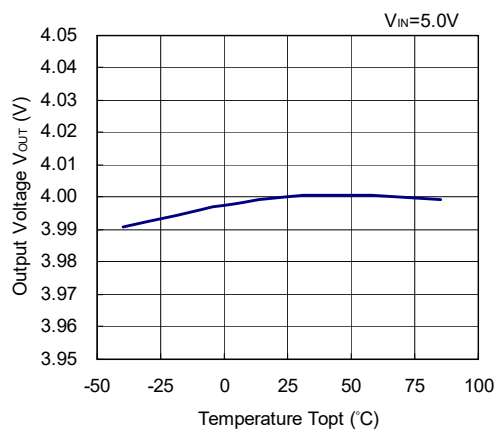

RP112x48xx

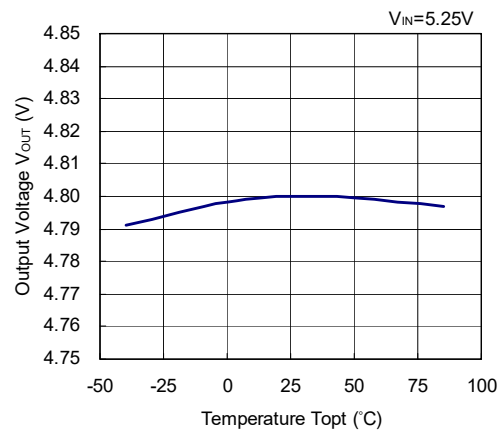

5) Supply Current vs. Temperature (C1 = Ceramic 1.0 μ F, C2 = Ceramic 1.0 μ F, $I_{OUT} = 0$ mA)

RP112x12xx

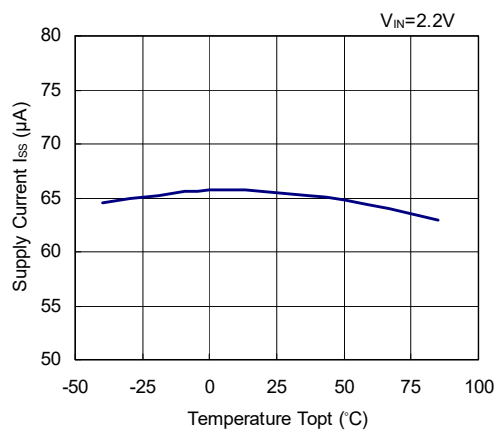

RP112x28xx

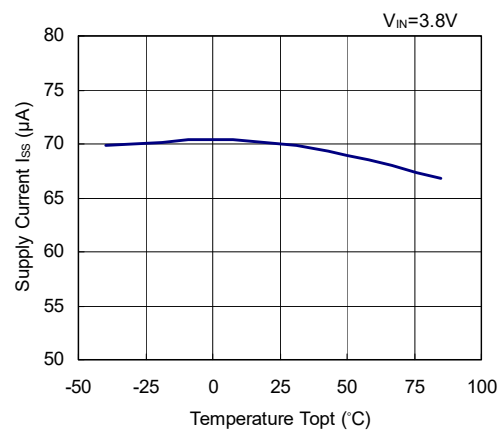

RP112x

No. EA-258-180621

RP112x40xx

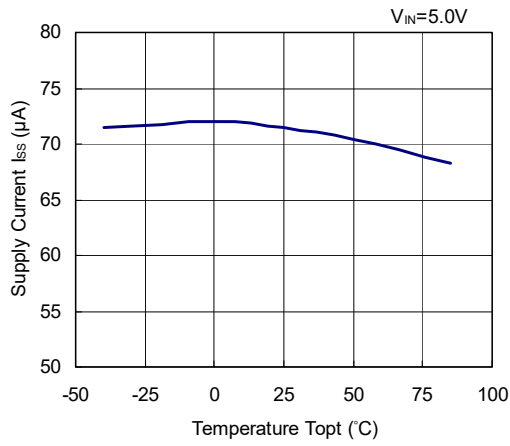

RP112x48xx

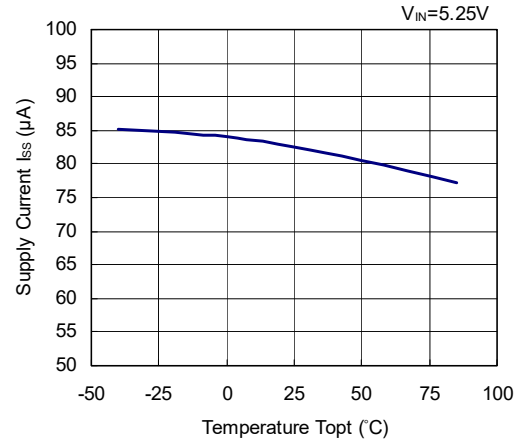

6) Dropout Voltage vs. Output Current (C1 = Ceramic 1.0 μF , C2 = Ceramic 1.0 μF)

RP112x12xx

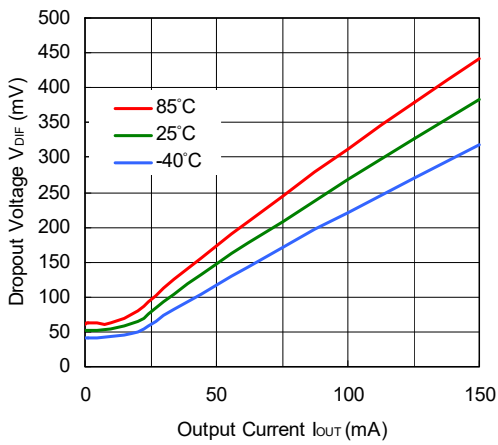

RP112x28xx

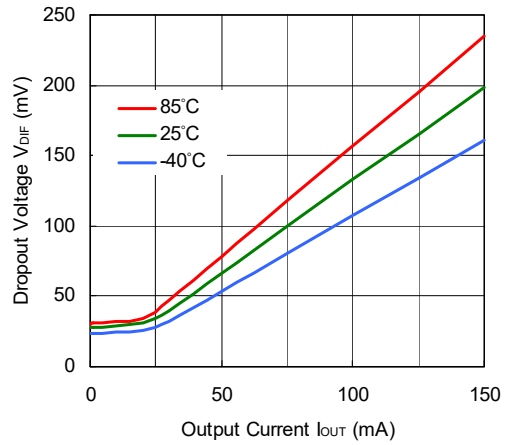

RP112x40xx

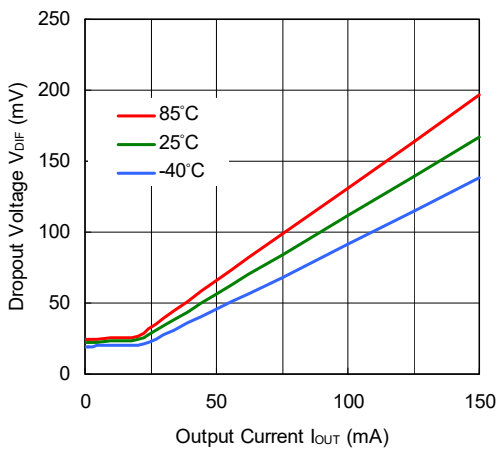

RP112x48xx

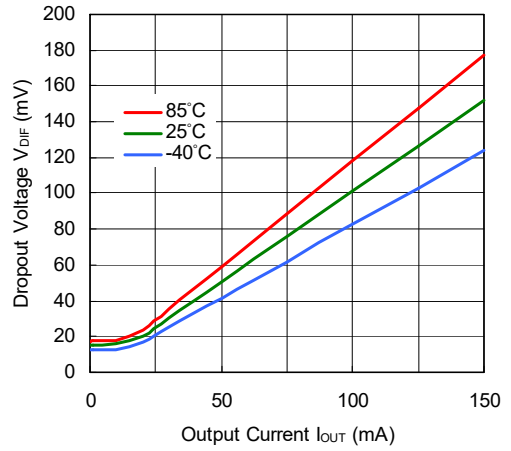

7) Dropout Voltage vs. Set Output Voltage (C1 = Ceramic 1.0 μ F, C2 = Ceramic 1.0 μ F, Ta = 25°C)

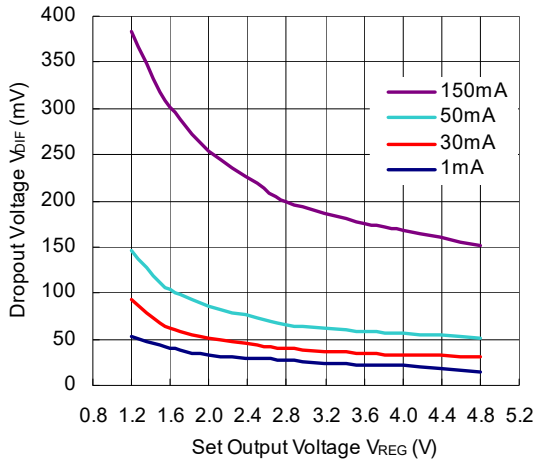

8) Dropout Voltage vs. Temperature (C1 = Ceramic 1.0 μ F, C2 = Ceramic 1.0 μ F)

RP112x12xx

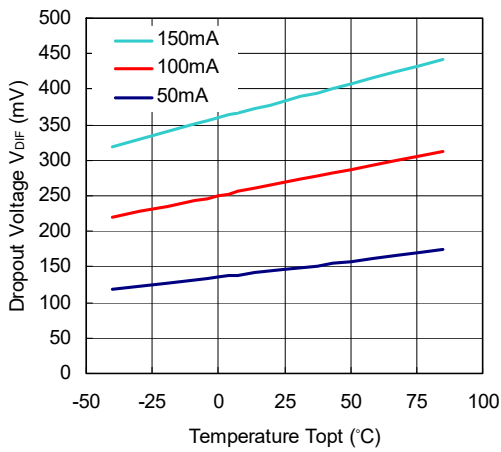

RP112x28xx

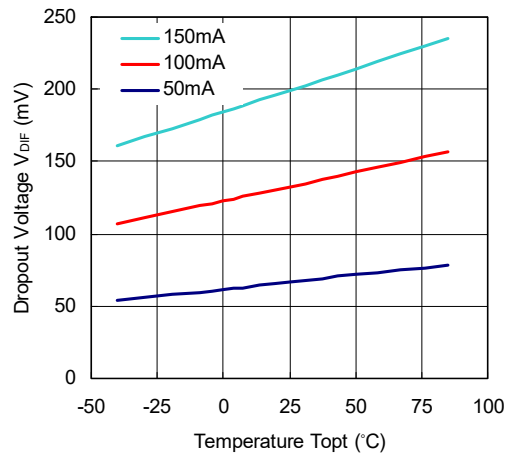

RP112x40xx

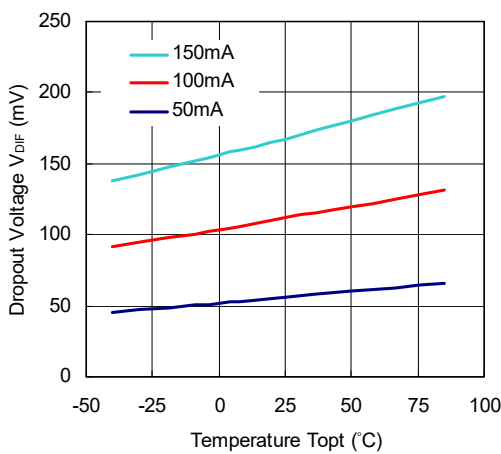

RP112x48xx

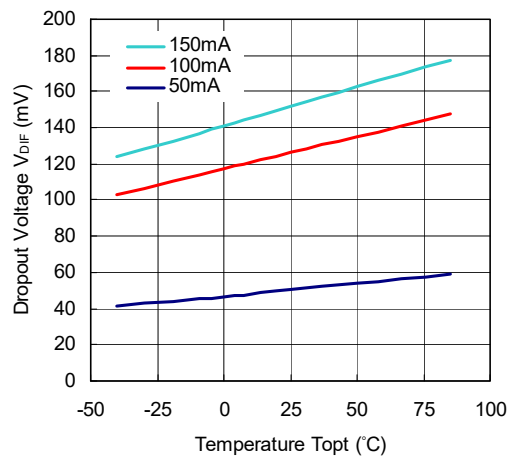

RP112x

No. EA-258-180621

9) Ripple Rejection vs. Input Voltage (C1 = none, C2 = Ceramic 1.0 μ F, Ripple = 0.2 Vp-p, Ta = 25°C)

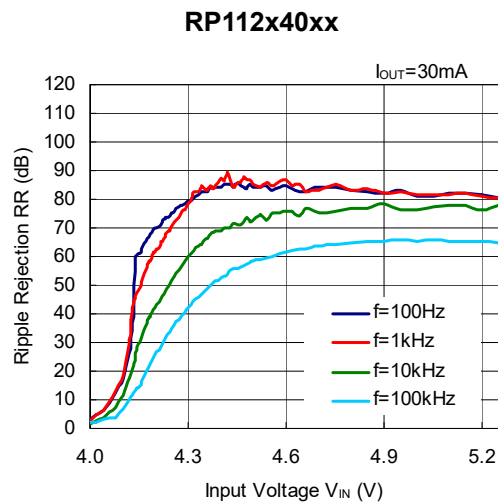
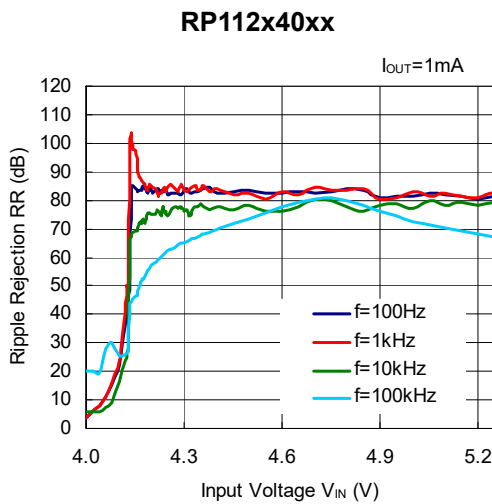
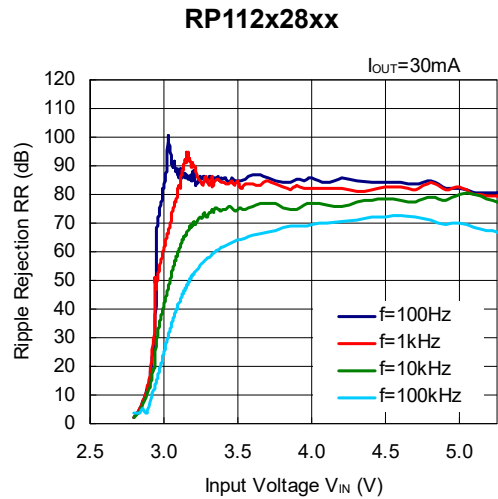
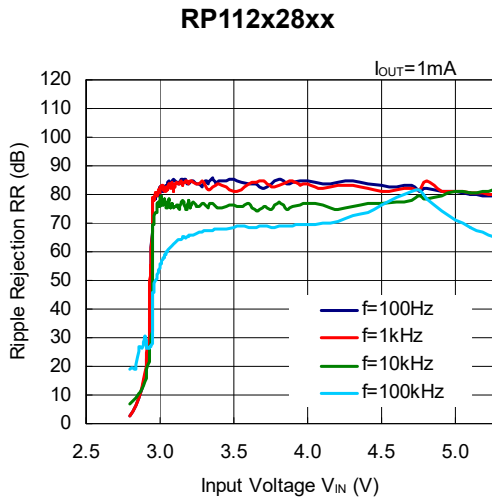
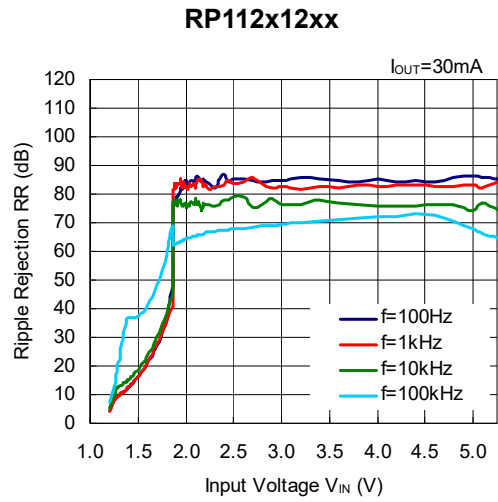
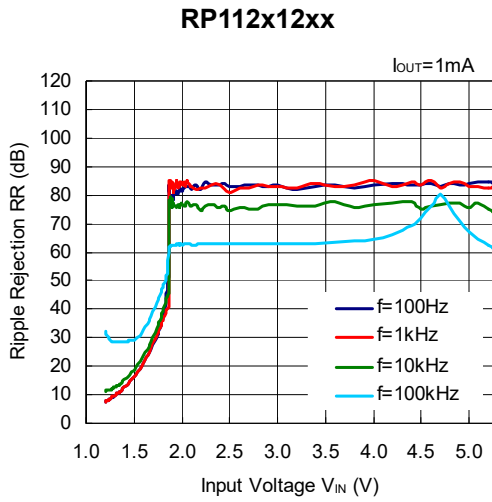

10) Ripple Rejection vs. Output Current (C1 = none, C2 = Ceramic 1.0μF, Ripple = 0.2 Vp-p, Ta = 25°C)

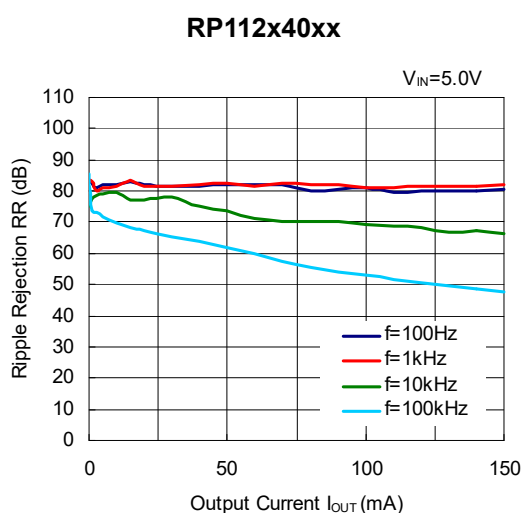
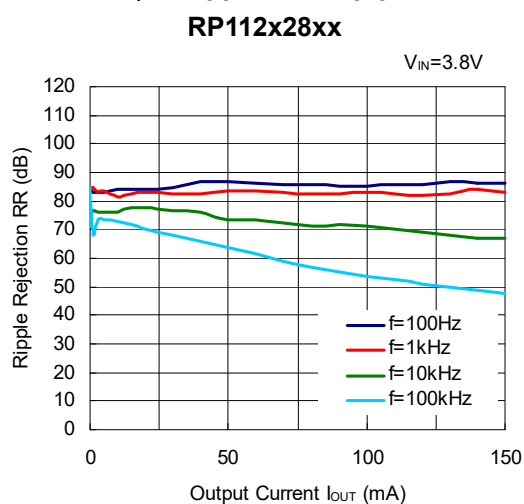
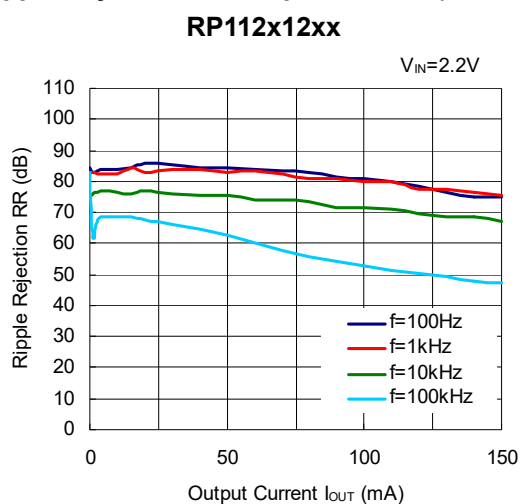

11) Ripple Rejection vs. Frequency (C1 = none, C2 = Ceramic 1.0 μF, Ripple = 0.2 Vp-p, Ta = 25°C)

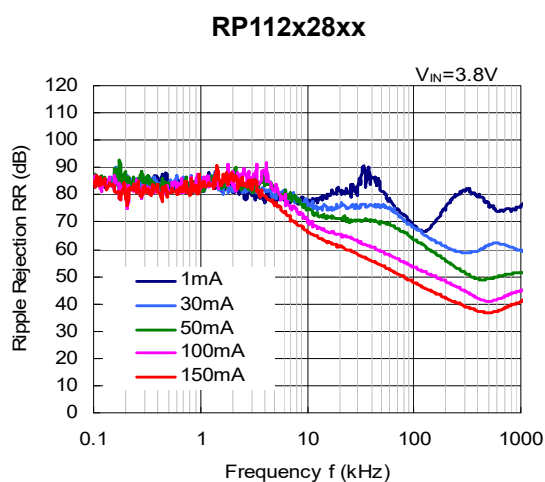
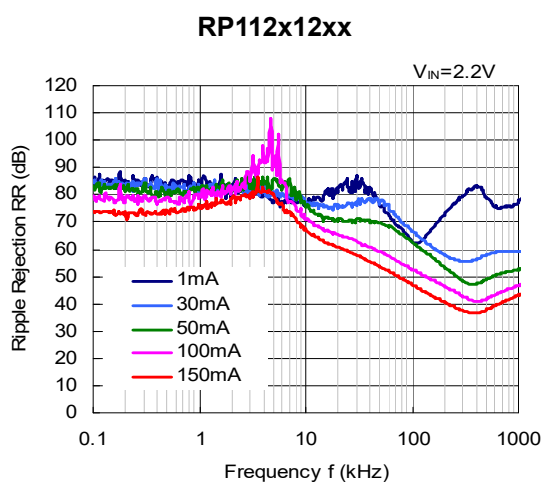

RP112x

No. EA-258-180621

RP112x40xx

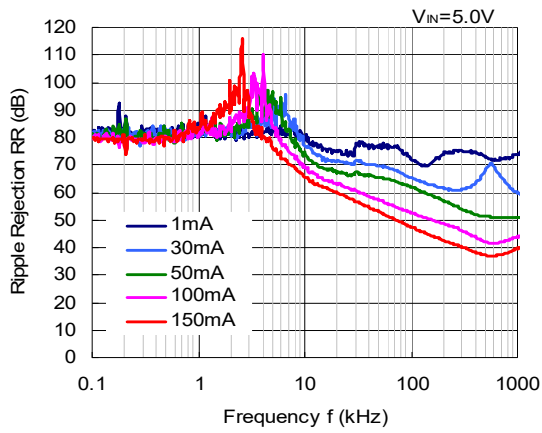

12) Output Spectral Noise Density vs. Frequency (C1 = none, C2 = Ceramic 1.0 μF , Ta = 25°C)

RP112x12xx

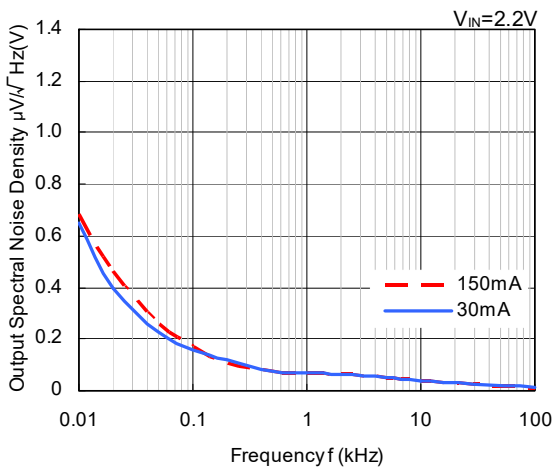

RP112x28xx

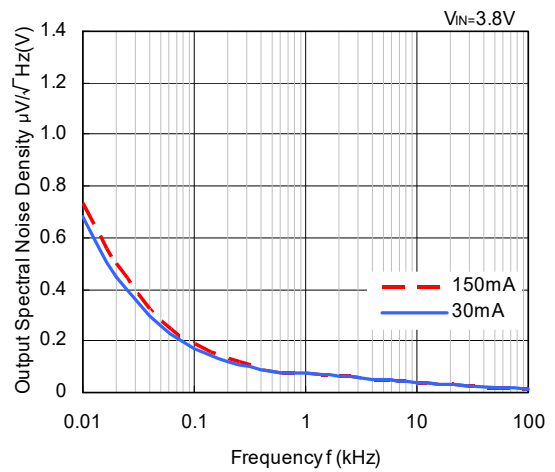

RP112x40xx

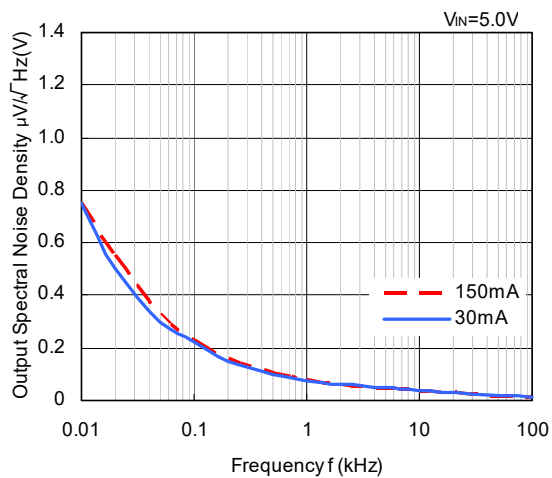

RP112x48xx

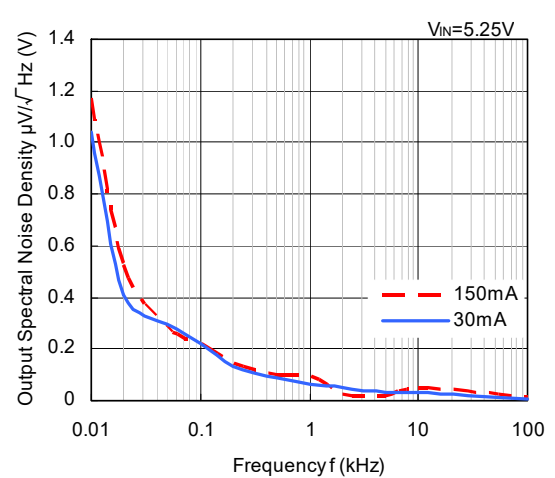

13) Input Transient Response (C1 = none, C2 = Ceramic 1.0 μ F, $I_{OUT} = 30\text{mA}$, $t_r = t_f = 5.0 \mu\text{s}$, $T_a = 25^\circ\text{C}$)

RP112x12xx

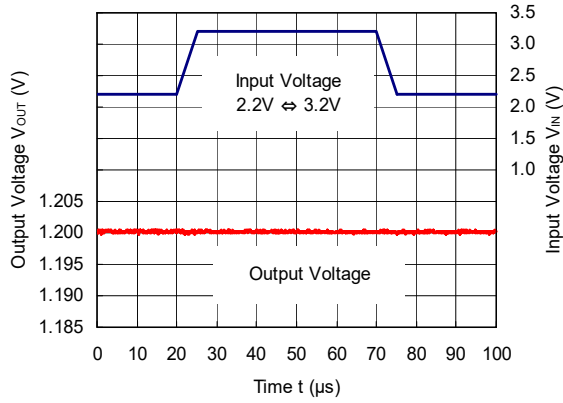

RP112x28xx

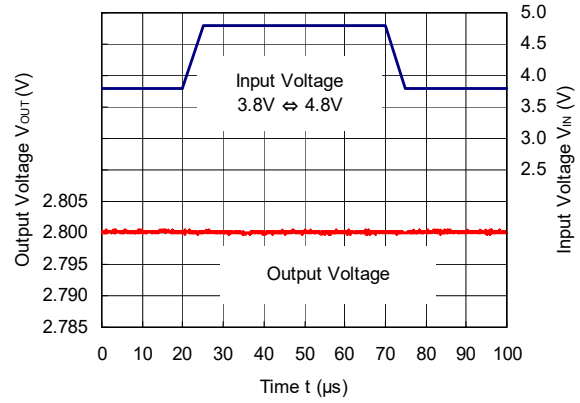

RP112x40xx

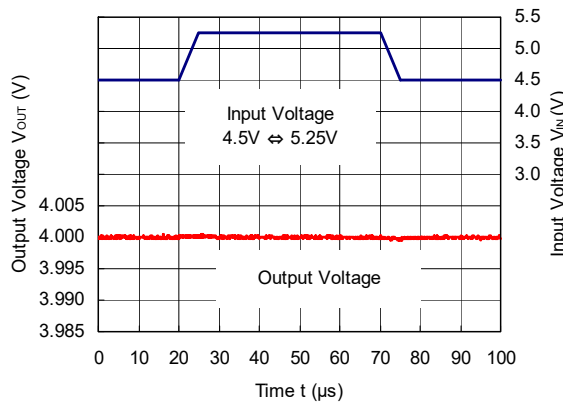

RP112x48xx

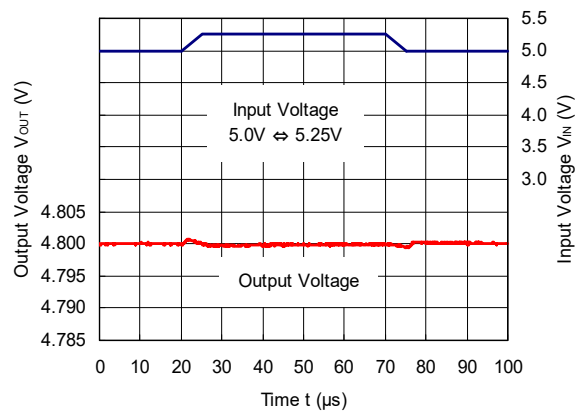

14) Load Transient Response (C1 = Ceramic 1.0 μ F, C2 = Ceramic 1.0 μ F, $t_r = t_f = 0.5 \mu\text{s}$, $T_a = 25^\circ\text{C}$)

RP112x12xx

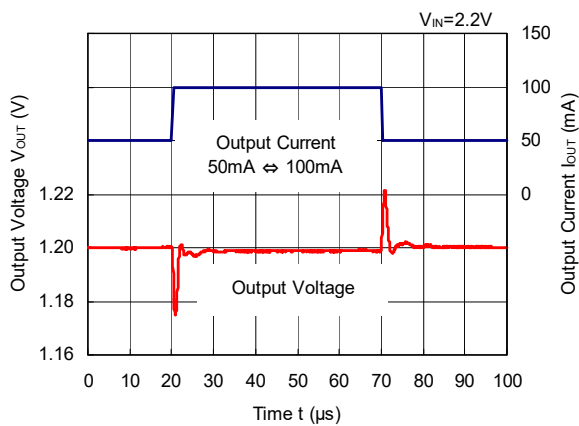

RP112x12xx

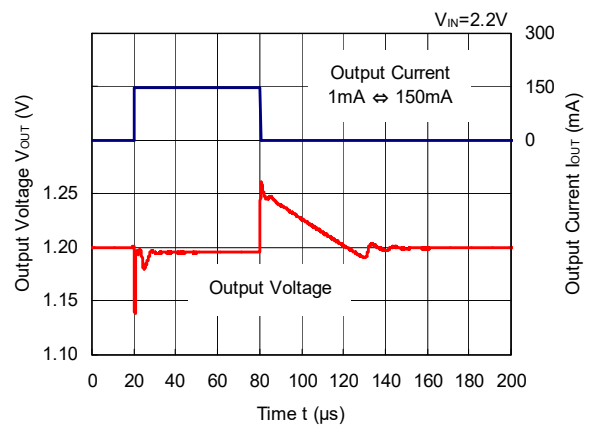

RP112x28xx

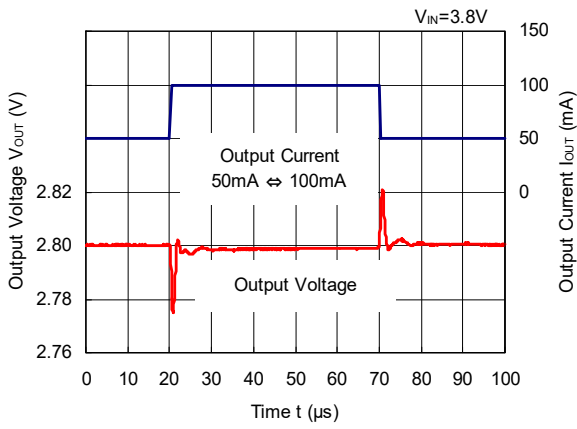

RP112x28xx

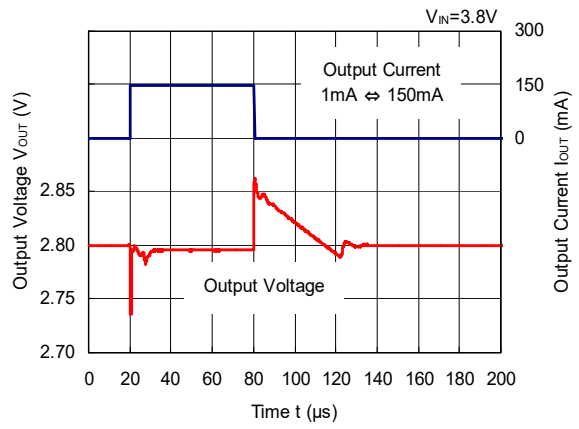

RP112x40xx

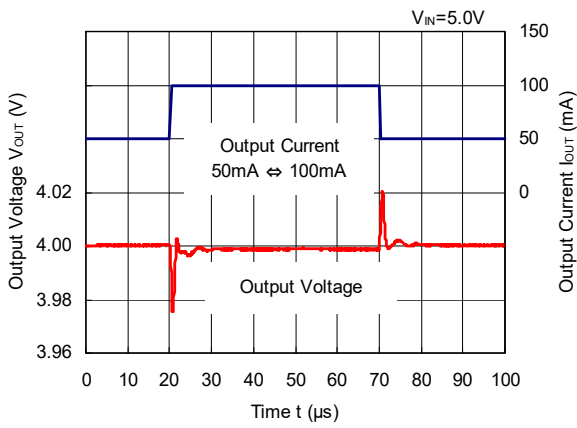

RP112x40xx

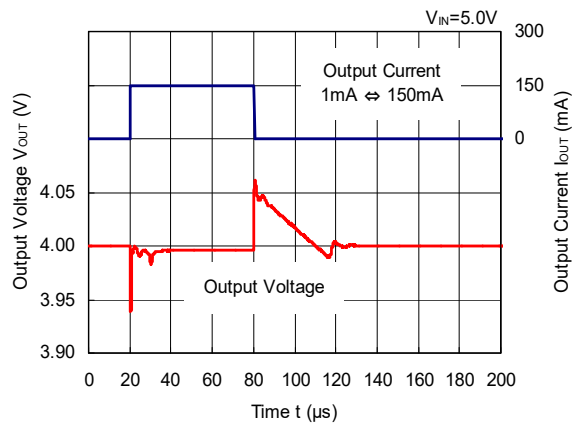

RP112x48xx

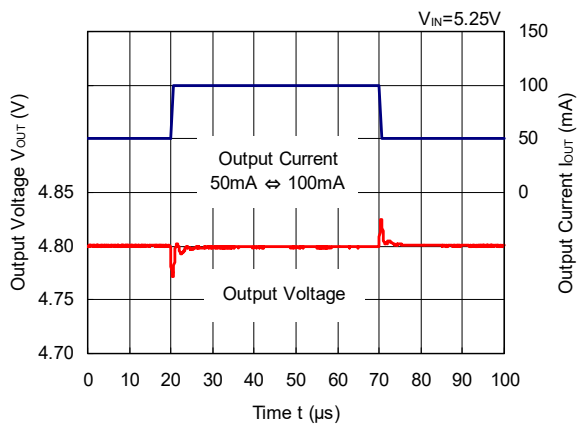

RP112x48xx

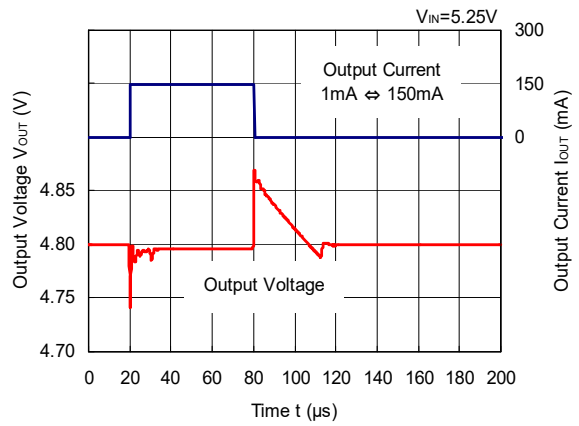

15) Turn on Speed with CE pin (C1 = Ceramic 1.0 μF, C2 = Ceramic 1.0 μF, Ta = 25°C)

RP112x12xx

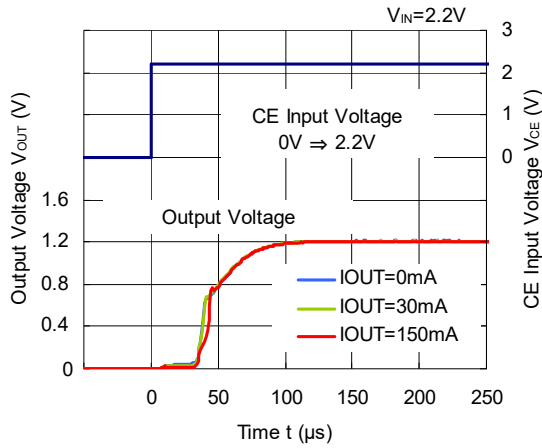

RP112x28xx

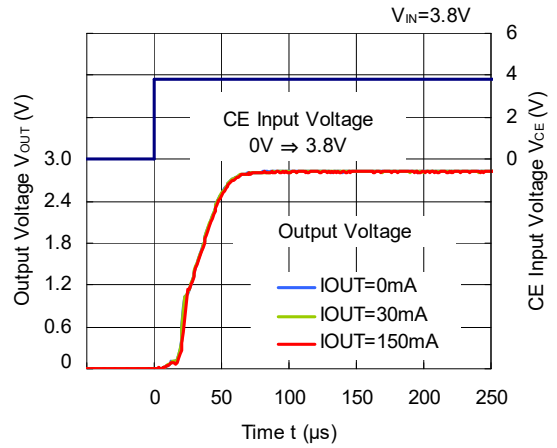

RP112x40xx

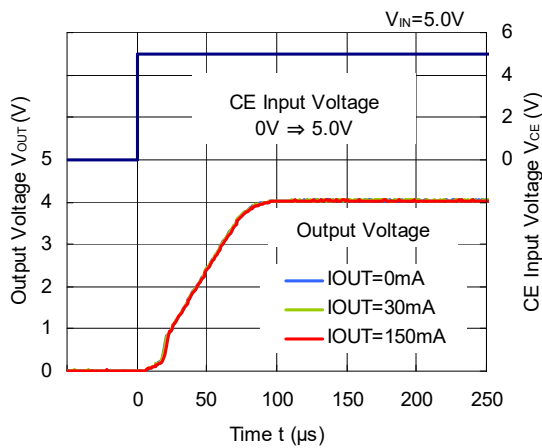

RP112x48xx

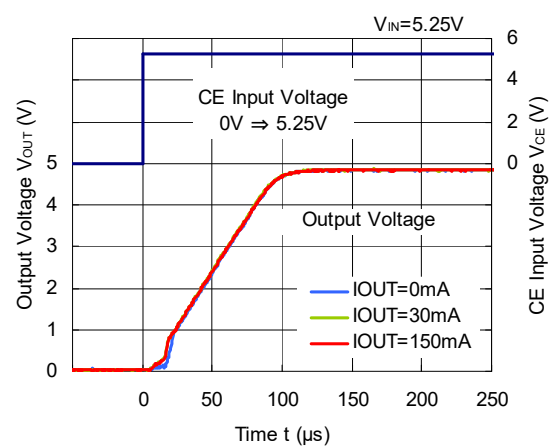

16) Turn off Speed with CE pin (RP112xxxxB) (C1 = Ceramic 1.0 μF, C2 = Ceramic 1.0 μF, Ta = 25°C)

RP112x12xx

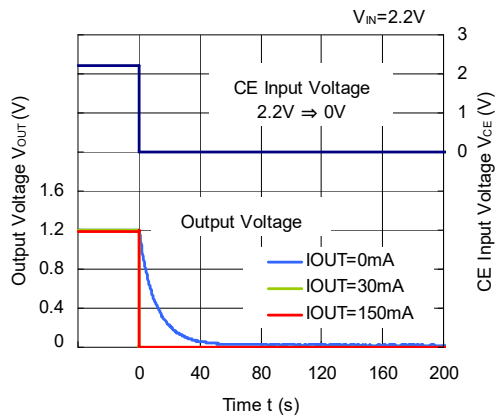

RP112x28xx

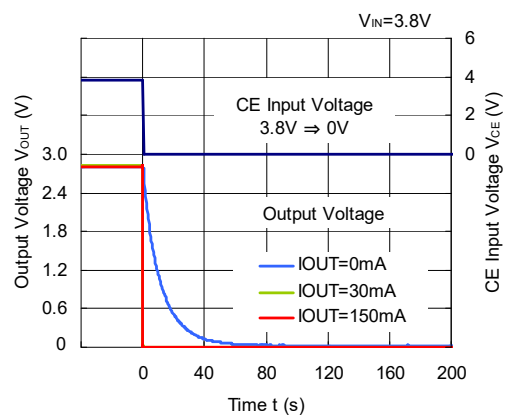

RP112x40xB

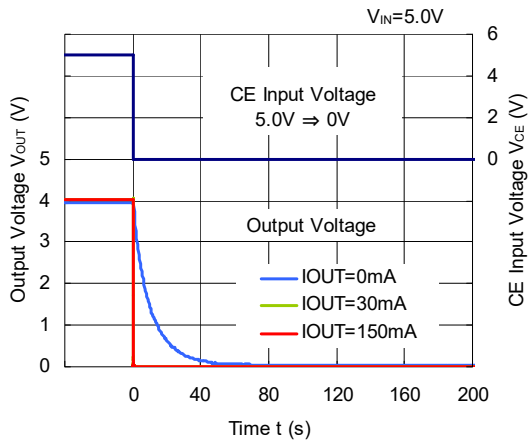

17) Turn off Speed with CE pin (RP112xxxxD) (C1 = Ceramic 1.0 μF , C2 = Ceramic 1.0 μF , $T_a = 25^\circ C$)

RP112x12xD

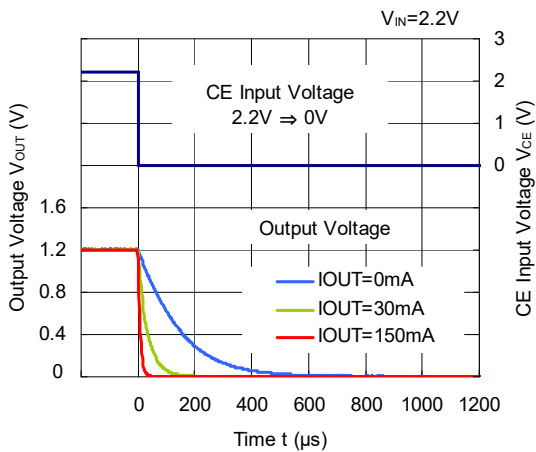

RP112x28xD

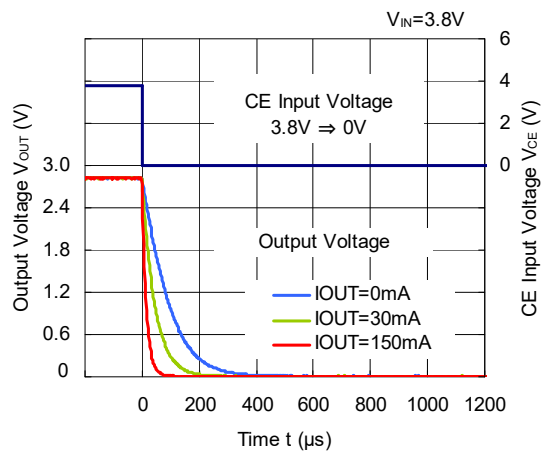

RP112x40xD

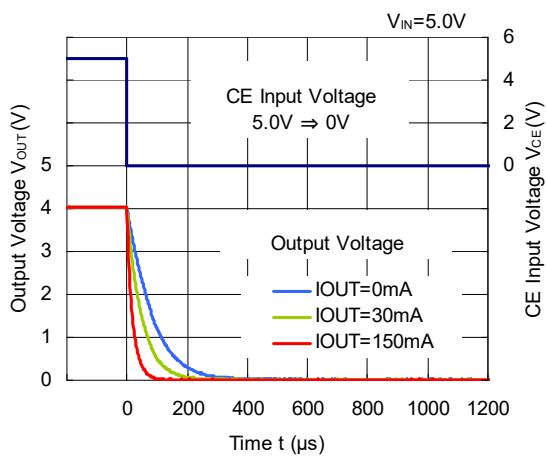

18) Inrush Current (C1 = Ceramic 1.0 μ F, I_{OUT} = 0 mA, Ta = 25°C)

RP112x12xx

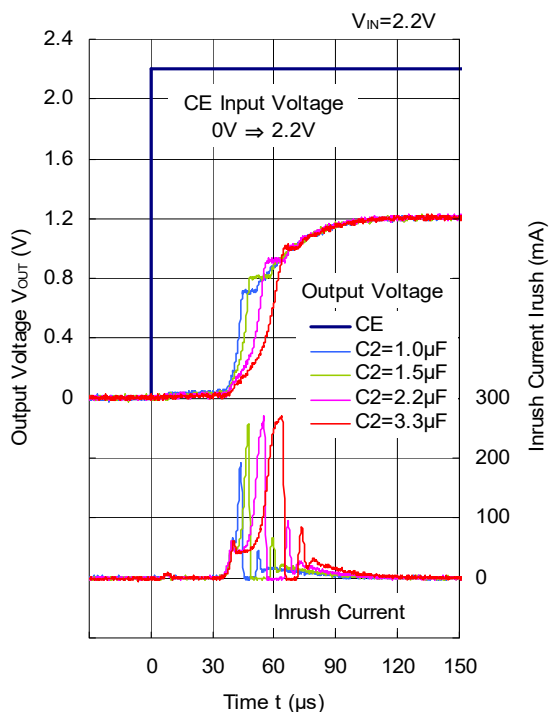

RP112x28xx

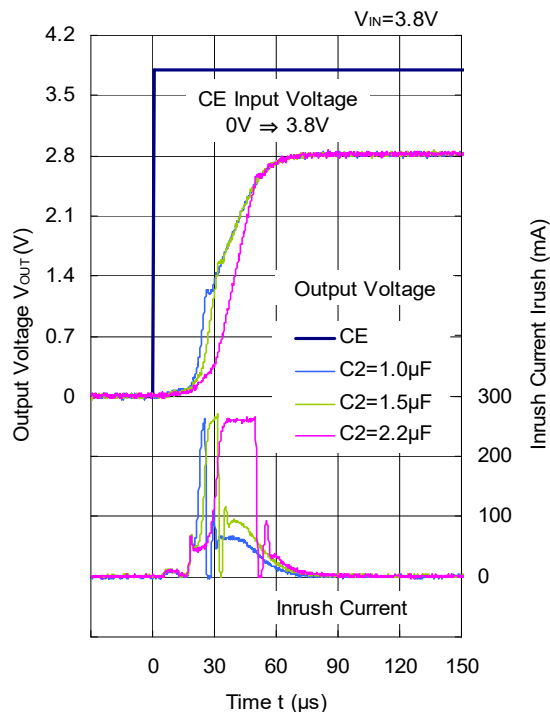

RP112x40xx

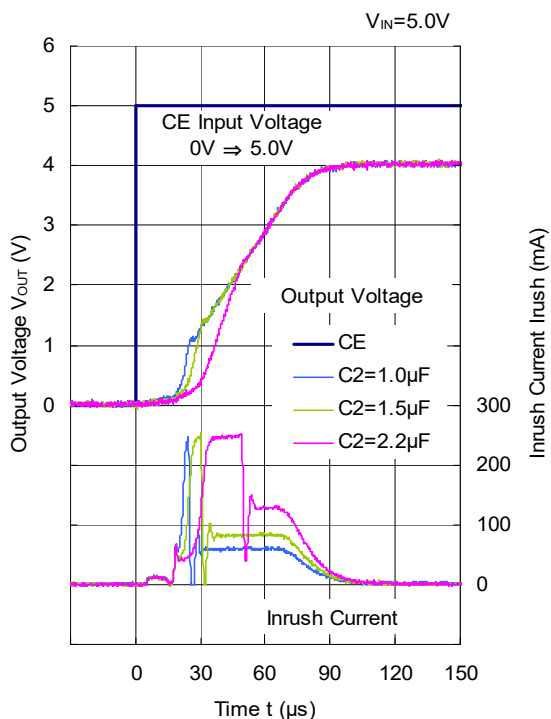

RP112x48xx

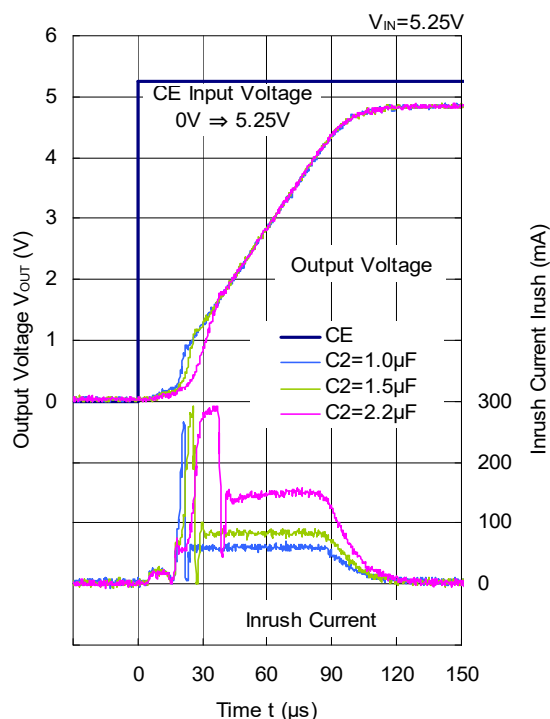

Equivalent Series Resistance vs. Output Current

When using these ICs, consider the following points:

The relations between I_{OUT} (Output Current) and ESR of an output capacitor are shown below.

The conditions when the white noise level is under $40\ \mu\text{V}$ (Avg.) are marked as the hatched area in the graph.

Measurement Conditions

Frequency Band: 10 Hz to 2 MHz

Temperature: -40°C to 85°C

Hatched Area: Noise level is under $40\ \mu\text{V}$ (Avg.)

C1, C2: $1.0\ \mu\text{F}$ or more

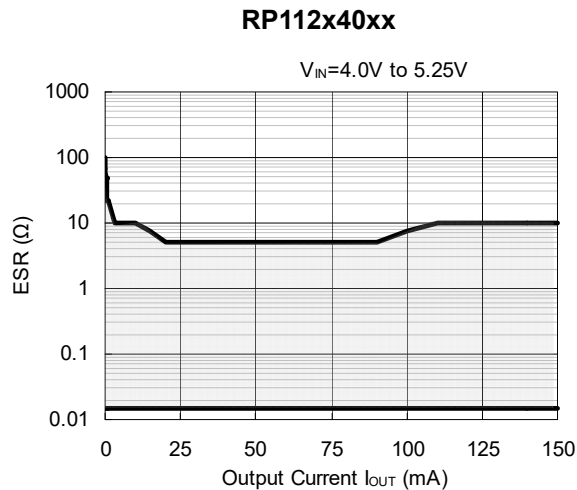
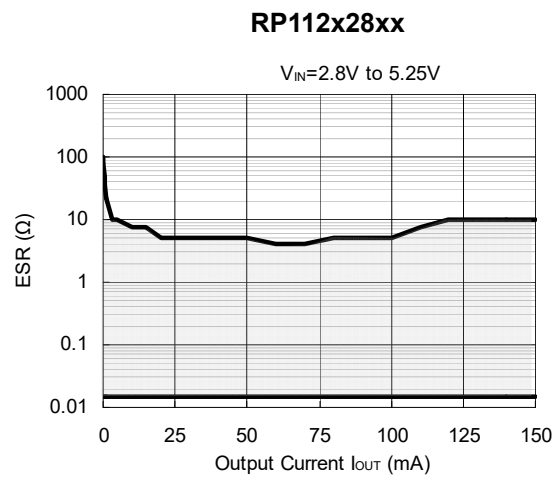
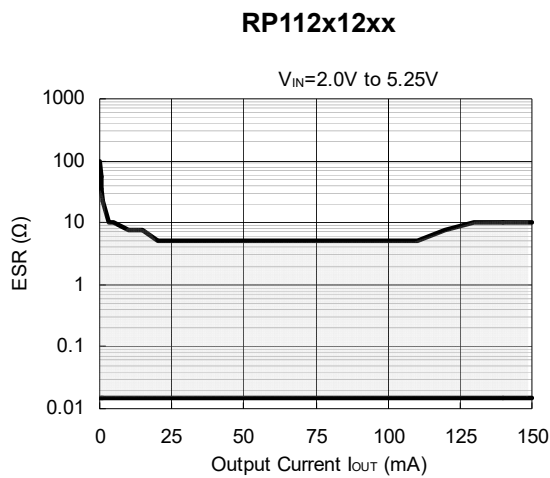

The power dissipation of the package is dependent on PCB material, layout, and environmental conditions. The following measurement conditions are based on JEDEC STD. 51-7.

Measurement Conditions

Item	Measurement Conditions
Environment	Mounting on Board (Wind Velocity = 0 m/s)
Board Material	Glass Cloth Epoxy Plastic (Four-Layer Board)
Board Dimensions	76.2 mm × 114.3 mm × 0.8 mm
Copper Ratio	Outer Layer (First Layer): Less than 95% of 50 mm Square Inner Layers (Second and Third Layers): Approx. 100% of 50 mm Square Outer Layer (Fourth Layer): Approx. 100% of 50 mm Square
Through-holes	φ 0.2 mm × 11 pcs

Measurement Result

(Ta = 25°C, Tjmax = 125°C)

Item	Measurement Result
Power Dissipation	800 mW
Thermal Resistance (θja)	θja = 125°C/W
Thermal Characterization Parameter (ψjt)	ψjt = 58°C/W

θja: Junction-to-Ambient Thermal Resistance

ψjt: Junction-to-Top Thermal Characterization Parameter

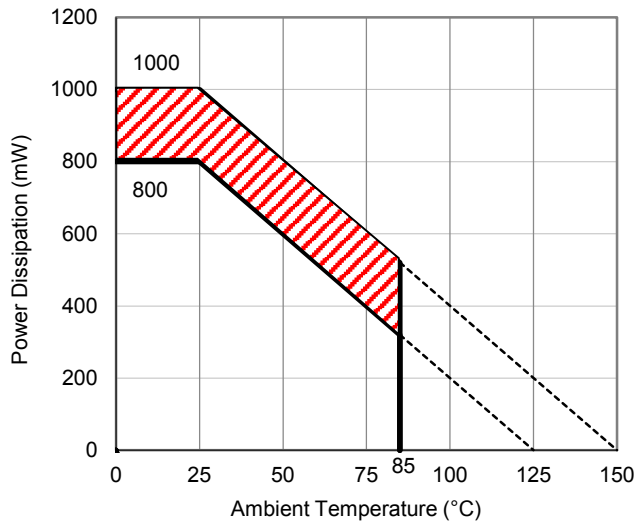

Power Dissipation vs. Ambient Temperature

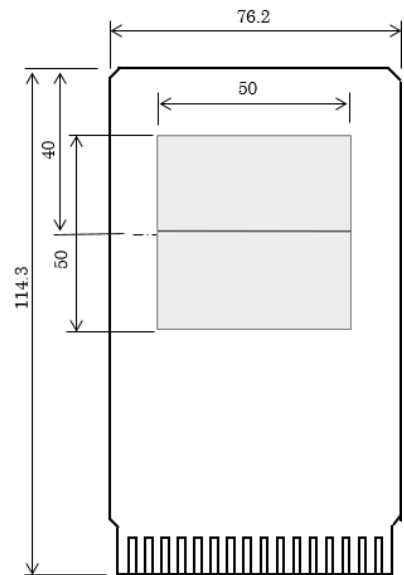

Measurement Board Pattern

The above graph shows the power dissipation of the package at Tjmax = 125°C and Tjmax = 150°C. Operating the device in the hatched range might have a negative influence on its lifetime. The total hours of use and the total years of use must be limited as follows:

Total Hours of Use	Total Years of Use (4 hours/day)
13,000 hours	9 years

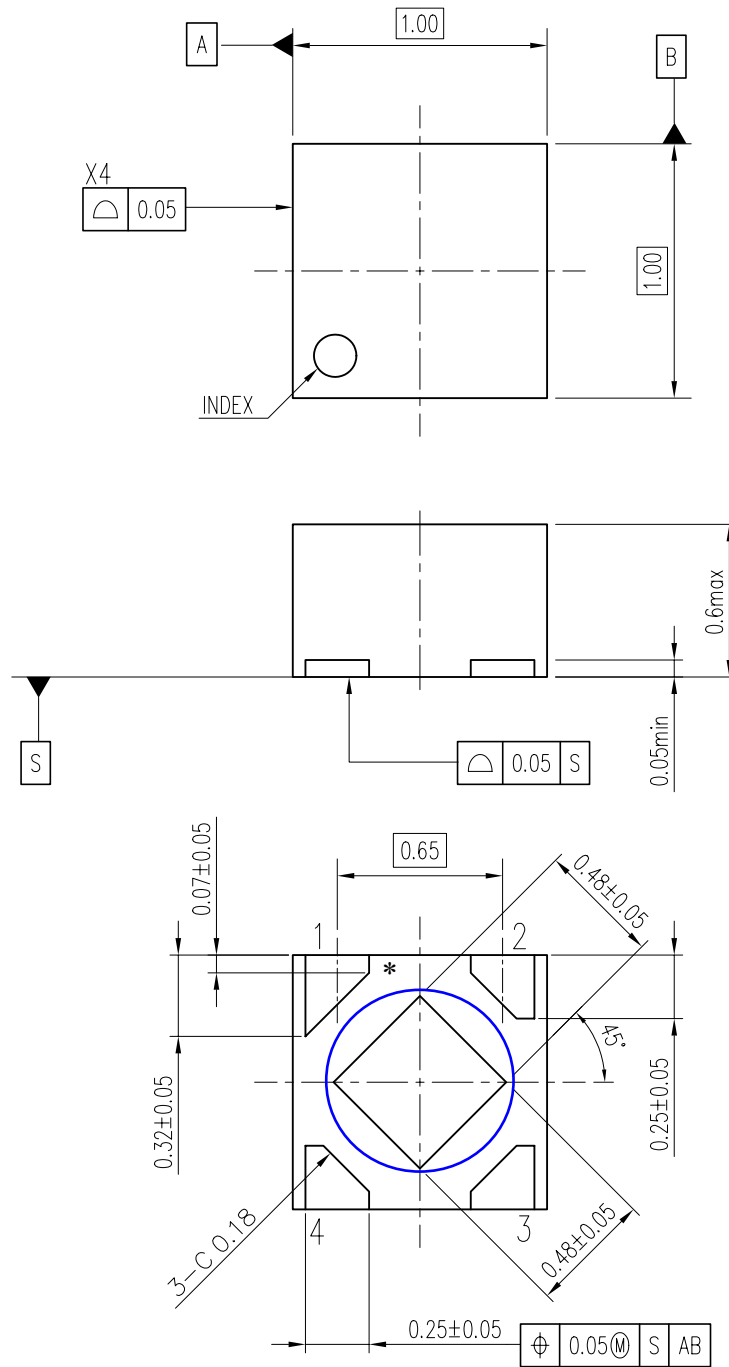

DFN(PLP)1010-4 Package Dimensions (Unit: mm)

* The tab on the bottom of the package shown by blue circle is a substrate potential (GND). It is recommended that this tab be connected to the ground plane on the board but it is possible to leave the tab floating.

The power dissipation of the package is dependent on PCB material, layout, and environmental conditions. The following conditions are used in this measurement.

Measurement Conditions

Item	Standard Test Land Pattern
Environment	Mounting on Board (Wind Velocity = 0 m/s)
Board Material	Glass Cloth Epoxy Plastic (Double-Sided Board)
Board Dimensions	40 mm × 40 mm × 1.6 mm
Copper Ratio	Top Side: Approx. 50% Bottom Side: Approx. 50%
Through-holes	φ 0.5 mm × 44 pcs

Measurement Result

(Ta = 25°C, Tjmax = 125°C)

Item	Standard Test Land Pattern
Power Dissipation	380 mW
Thermal Resistance (θja)	θja = 263°C/W
Thermal Characterization Parameter (ψjt)	ψjt = 75°C/W

θja: Junction-to-Ambient Thermal Resistance

ψjt: Junction-to-Top Thermal Characterization Parameter

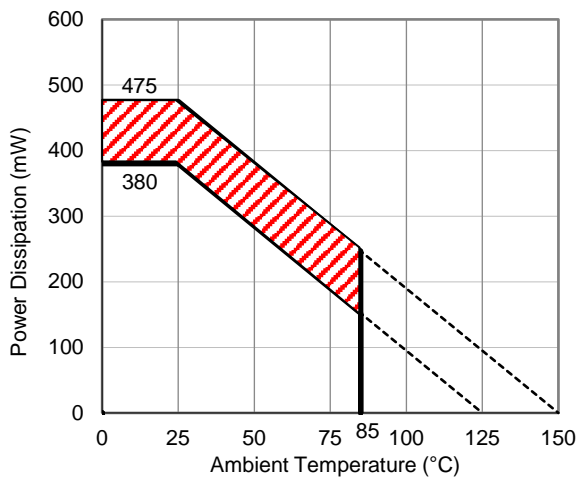

Power Dissipation vs. Ambient Temperature

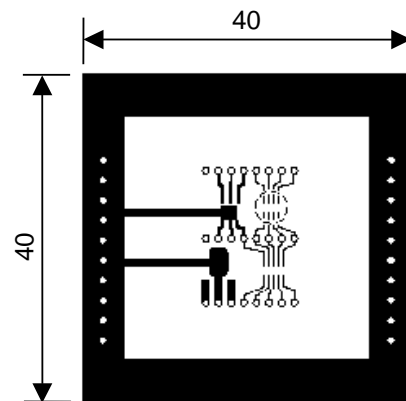

Measurement Board Pattern

The above graph shows the power dissipation of the package at Tjmax = 125°C and Tjmax = 150°C. Operating the device in the hatched range might have a negative influence on its lifetime. The total hours of use and the total years of use must be limited as follows:

Total Hours of Use	Total Years of Use (4 hours/day)
13,000 hours	9 years

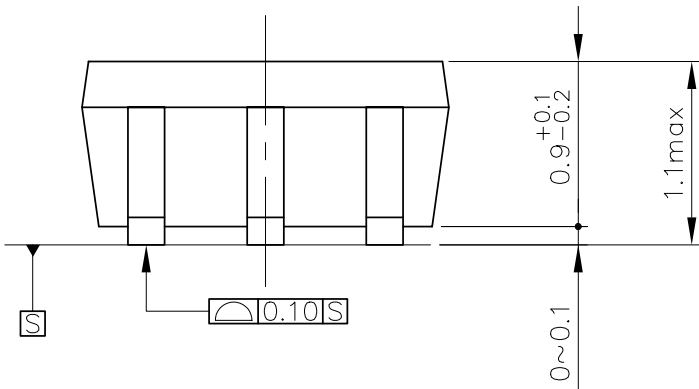
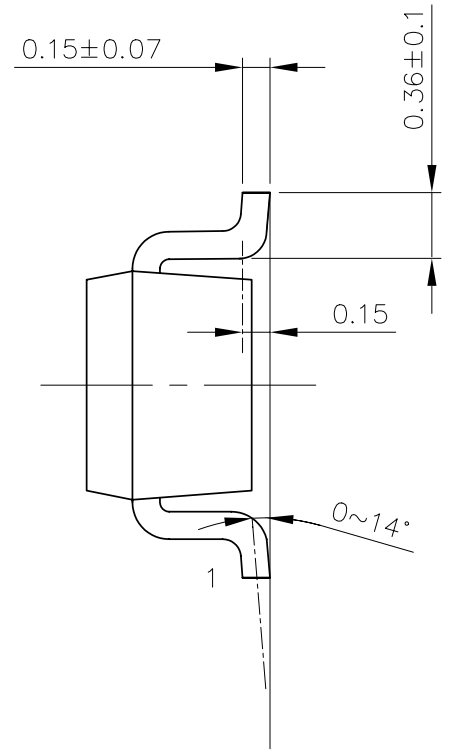
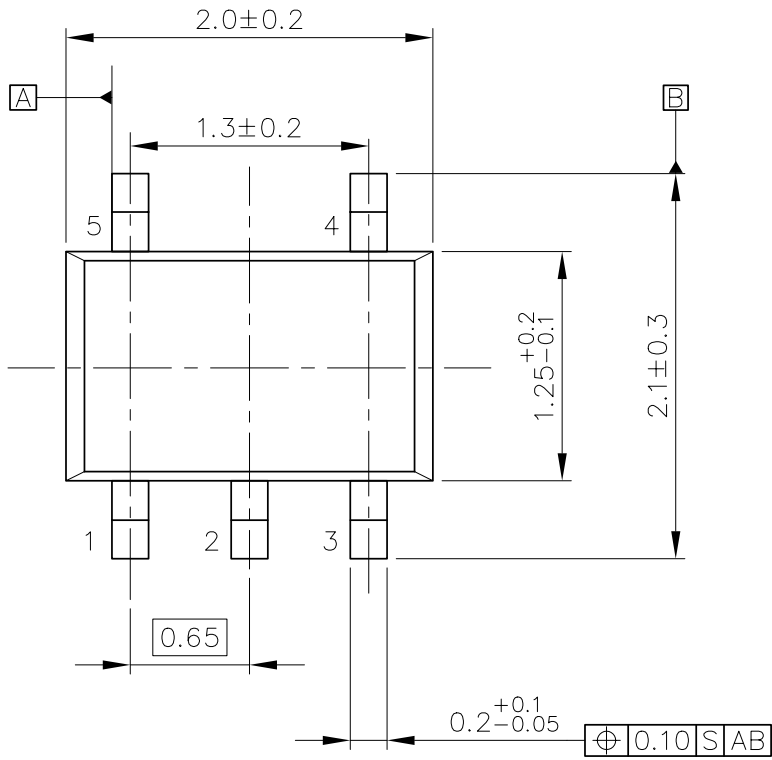

UNIT: mm

SC-88A Package Dimensions

The power dissipation of the package is dependent on PCB material, layout, and environmental conditions. The following measurement conditions are based on JEDEC STD. 51-7.

Measurement Conditions

Item	Measurement Conditions
Environment	Mounting on Board (Wind Velocity = 0 m/s)
Board Material	Glass Cloth Epoxy Plastic (Four-Layer Board)
Board Dimensions	76.2 mm × 114.3 mm × 0.8 mm
Copper Ratio	Outer Layer (First Layer): Less than 95% of 50 mm Square Inner Layers (Second and Third Layers): Approx. 100% of 50 mm Square Outer Layer (Fourth Layer): Approx. 100% of 50 mm Square
Through-holes	φ 0.3 mm × 7 pcs

Measurement Result

(Ta = 25°C, Tjmax = 125°C)

Item	Measurement Result
Power Dissipation	660 mW
Thermal Resistance (θja)	θja = 150°C/W
Thermal Characterization Parameter (ψjt)	ψjt = 51°C/W

θja: Junction-to-Ambient Thermal Resistance

ψjt: Junction-to-Top Thermal Characterization Parameter

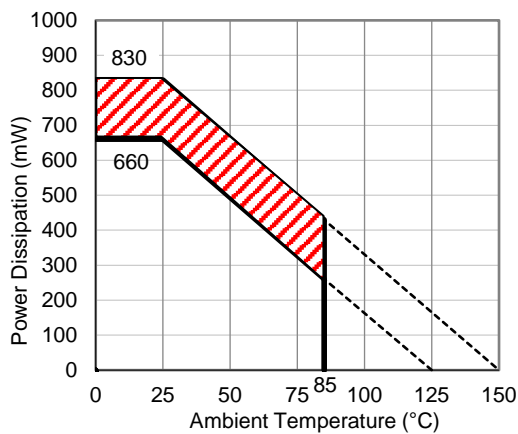

Power Dissipation vs. Ambient Temperature

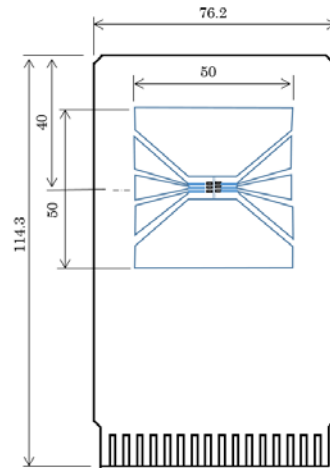

Measurement Board Pattern

The above graph shows the power dissipation of the package at Tjmax = 125°C and Tjmax = 150°C. Operating the device in the hatched range might have a negative influence on its lifetime. The total hours of use and the total years of use must be limited as follows:

Total Hours of Use	Total Years of Use (4 hours/day)
13,000 hours	9 years

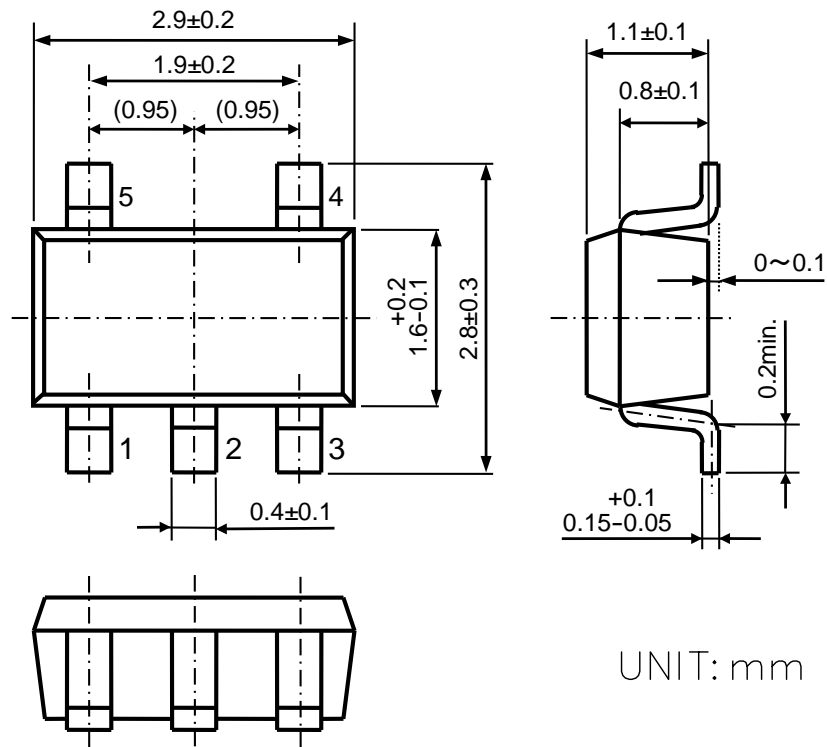

UNIT: mm

SOT-23-5 Package Dimensions



1. The products and the product specifications described in this document are subject to change or discontinuation of production without notice for reasons such as improvement. Therefore, before deciding to use the products, please refer to Ricoh sales representatives for the latest information thereon.
2. The materials in this document may not be copied or otherwise reproduced in whole or in part without prior written consent of Ricoh.
3. Please be sure to take any necessary formalities under relevant laws or regulations before exporting or otherwise taking out of your country the products or the technical information described herein.
4. The technical information described in this document shows typical characteristics of and example application circuits for the products. The release of such information is not to be construed as a warranty of or a grant of license under Ricoh's or any third party's intellectual property rights or any other rights.
5. The products listed in this document are intended and designed for use as general electronic components in standard applications (office equipment, telecommunication equipment, measuring instruments, consumer electronic products, amusement equipment etc.). Those customers intending to use a product in an application requiring extreme quality and reliability, for example, in a highly specific application where the failure or misoperation of the product could result in human injury or death (aircraft, spacevehicle, nuclear reactor control system, traffic control system, automotive and transportation equipment, combustion equipment, safety devices, life support system etc.) should first contact us.
6. We are making our continuous effort to improve the quality and reliability of our products, but semiconductor products are likely to fail with certain probability. In order to prevent any injury to persons or damages to property resulting from such failure, customers should be careful enough to incorporate safety measures in their design, such as redundancy feature, fire containment feature and fail-safe feature. We do not assume any liability or responsibility for any loss or damage arising from misuse or inappropriate use of the products.
7. Anti-radiation design is not implemented in the products described in this document.
8. The X-ray exposure can influence functions and characteristics of the products. Confirm the product functions and characteristics in the evaluation stage.
9. WLCSP products should be used in light shielded environments. The light exposure can influence functions and characteristics of the products under operation or storage.
10. There can be variation in the marking when different AOI (Automated Optical Inspection) equipment is used. In the case of recognizing the marking characteristic with AOI, please contact Ricoh sales or our distributor before attempting to use AOI.
11. Please contact Ricoh sales representatives should you have any questions or comments concerning the products or the technical information.



Ricoh is committed to reducing the environmental loading materials in electrical devices with a view to contributing to the protection of human health and the environment.

Ricoh has been providing RoHS compliant products since April 1, 2006 and Halogen-free products since April 1, 2012.

RICOH RICOH ELECTRONIC DEVICES CO., LTD.

<https://www.e-devices.ricoh.co.jp/en/>

Sales & Support Offices

Ricoh Electronic Devices Co., Ltd.

Shin-Yokohama Office (International Sales)

2-3, Shin-Yokohama 3-chome, Kohoku-ku, Yokohama-shi, Kanagawa, 222-8530, Japan
Phone: +81-50-3814-7687 Fax: +81-45-474-0074

Ricoh Americas Holdings, Inc.

675 Campbell Technology Parkway, Suite 200 Campbell, CA 95008, U.S.A.
Phone: +1-408-610-3105

Ricoh Europe (Netherlands) B.V.

Semiconductor Support Centre

Prof. W.H. Keesomlaan 1, 1183 DJ Amstelveen, The Netherlands
Phone: +31-20-5474-309

Ricoh International B.V. - German Branch

Semiconductor Sales and Support Centre

Oberrather Strasse 6, 40472 Düsseldorf, Germany
Phone: +49-211-6546-0

Ricoh Electronic Devices Korea Co., Ltd.

3F, Haesung Bldg, 504, Teheran-ro, Gangnam-gu, Seoul, 135-725, Korea
Phone: +82-2-2135-5700 Fax: +82-2-2051-5713

Ricoh Electronic Devices Shanghai Co., Ltd.

Room 403, No.2 Building, No.690 Bibo Road, Pu Dong New District, Shanghai 201203,
People's Republic of China
Phone: +86-21-5027-3200 Fax: +86-21-5027-3299

Ricoh Electronic Devices Shanghai Co., Ltd.

Shenzhen Branch

1205, Block D (Jinlong Building), Kingkey 100, Hongbao Road, Luohu District,
Shenzhen, China
Phone: +86-755-8348-7600 Ext 225

Ricoh Electronic Devices Co., Ltd.

Taipei office

Room 109, 10F-1, No.51, Hengyang Rd., Taipei City, Taiwan
Phone: +886-2-2313-1621/1622 Fax: +886-2-2313-1623

Mouser Electronics

Authorized Distributor

Click to View Pricing, Inventory, Delivery & Lifecycle Information:

Ricoh Electronics:

[RP112Q122D-TR-FE](#) [RP112K451D-TR](#) [RP112Q182D-TR-FE](#) [RP112Q332D-TR-FE](#) [RP112N121D-TR-FE](#)
[RP112Q252D-TR-FE](#) [RP112Q152D-TR-FE](#) [RP112Q302D-TR-FE](#) [RP112Q352D-TR-FE](#) [RP112Q342D-TR-FE](#)
[RP112K181D-TR](#) [RP112N151D-TR-FE](#) [RP112K331D-TR](#) [RP112Q282D-TR-FE](#) [RP112N331D-TR-FE](#) [RP112N451D-TR-FE](#)
[RP112N181D-TR-FE](#) [RP112N301D-TR-FE](#) [RP112N251D-TR-FE](#) [RP112K301D-TR](#) [RP112N281D-TR-FE](#)
[RP112K281D-TR](#) [RP112K261D-TR](#) [RP112K131D-TR](#) [RP112N351D-TR-FE](#) [RP112N131D-TR-FE](#) [RP112N241D-TR-FE](#)
[RP112N451B-TR-FE](#) [RP112N231D-TR-FE](#) [RP112K231D-TR](#) [RP112K291D-TR](#) [RP112K351D-TR](#) [RP112K271D-TR](#)
[RP112N381D-TR-FE](#) [RP112K301B-TR](#) [RP112K121B-TR](#) [RP112K121D-TR](#) [RP112K151B-TR](#) [RP112K151D-TR](#)
[RP112K181B-TR](#) [RP112K251B-TR](#) [RP112Q452D-TR-FE](#) [RP112Q302B-TR-FE](#) [RP112Q312B-TR-FE](#)
[RP112Q312D-TR-FE](#) [RP112Q332B-TR-FE](#) [RP112Q402B-TR-FE](#) [RP112Q402D-TR-FE](#) [RP112Q132D-TR-FE](#)
[RP112Q152B-TR-FE](#) [RP112Q172D-TR-FE](#) [RP112Q182B-TR-FE](#) [RP112Q252B-TR-FE](#) [RP112Q282B-TR-FE](#)
[RP112N311D-TR-FE](#) [RP112N331B-TR-FE](#) [RP112N401B-TR-FE](#) [RP112N401D-TR-FE](#) [RP112N481D-TR-FE](#)
[RP112Q122B-TR-FE](#) [RP112N181B-TR-FE](#) [RP112N201D-TR-FE](#) [RP112N251B-TR-FE](#) [RP112N281B-TR-FE](#)
[RP112N301B-TR-FE](#) [RP112N311B-TR-FE](#) [RP112K421D-TR](#) [RP112K441D-TR](#) [RP112K481D-TR](#) [RP112N121B-TR-FE](#)
[RP112N151B-TR-FE](#) [RP112N171D-TR-FE](#) [RP112K331B-TR](#) [RP112K341D-TR](#) [RP112K361D-TR](#) [RP112K401B-TR](#)
[RP112K401D-TR](#) [RP112K411D-TR](#) [RP112K251D-TR](#) [RP112K271B-TR](#) [RP112K281B-TR](#) [RP112K291B-TR](#)
[RP112K311B-TR](#) [RP112K311D-TR](#) [RP112K221D-TR](#)