

TOSHIBA BiCD Integrated Circuit Silicon Monolithic

TB6588FG

3-Phase Full-Wave PWM Driver for Sensorless DC Motors

The TB6588FG is a three-phase full-wave PWM driver for sensorless brushless DC (BLDC) motors. It controls rotation speed by changing the PWM duty cycle, based on the voltage of an analog control input.

Features

- Sensorless drive in three-phase full-wave mode
- PWM chopper control
- Controls the PWM duty cycle, based on an analog input (7-bit ADC)
- Output current: $I_{OUT} = 1.5 \text{ A typ. (2.5 A max)}$
- Power supply: $V_M = 7 \text{ to } 42 \text{ V (50 V max)}$
- Overcurrent protection
- Forward and reverse rotation
- Lead angle control ($0^\circ, 7.5^\circ, 15^\circ, 30^\circ$)
- Overlapping commutation
- Rotation speed detecting signal
- DC excitation mode to improve starting characteristics
- Adjustable DC excitation time and forced commutation time for a startup operation
- Forced commutation frequency control: $f_{osc}/(6 \times 2^{16}), f_{osc}/(6 \times 2^{17}), f_{osc}/(6 \times 2^{18}), f_{osc}/(6 \times 2^{19})$

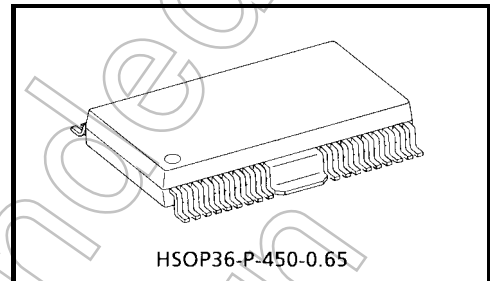

Weight: 0.79 g (typ.)

Not Recommended for New Design

Pin Assignment

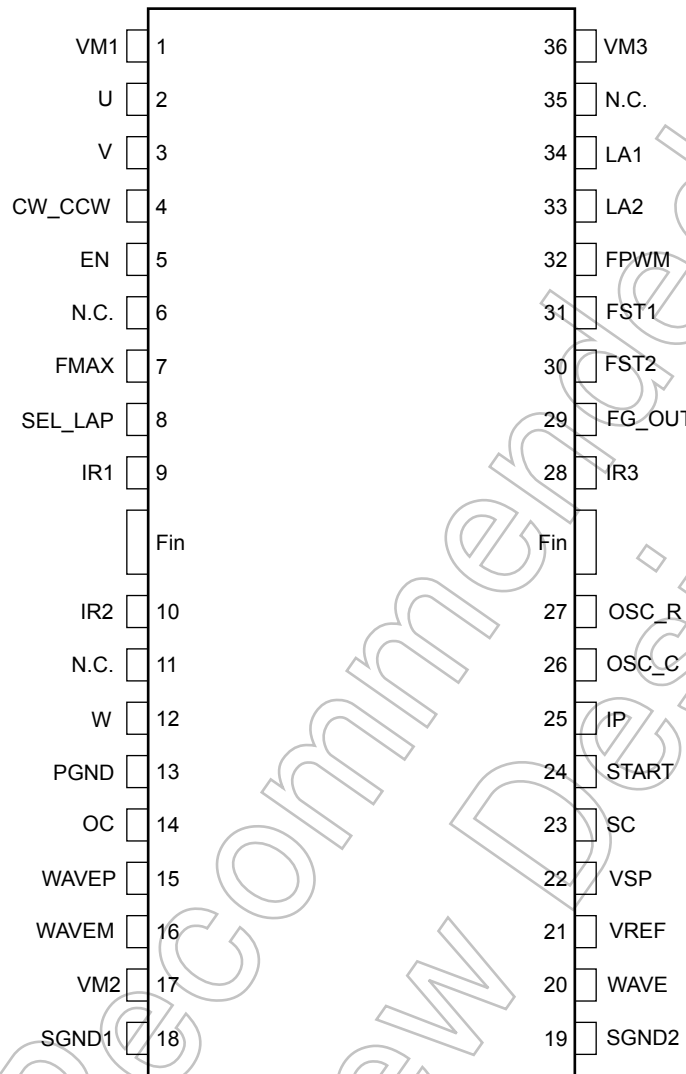

Not Recommended for New Design

Pin Description

Pin No.	Symbol	I/O	Description
1	VM1	—	Motor power supply pin (VM = 7 to 42 V). VM1, VM2 and VM3 are connected together inside the IC.
2	U	O	U-phase output
3	V	O	V-phase output
4	CW_CCW	I	Rotation direction select input (This pin has a pull-up resistor.) H or open: Clockwise (U → V → W) L: Counterclockwise (U → W → V)
5	EN	I	Protection enable input (This pin has a pull-up resistor.) This input determines whether or not to enable the protection functionality when either of the following conditions is true: a) the maximum commutation frequency is exceeded. b) the rotation speed falls below the forced commutation frequency. H or open: Protection functionality enabled L: Protection functionality disabled
6	N.C.	—	No-connect
7	FMAX	I	Selects the upper limit of the maximum commutation frequency. (This pin has a pull-up resistor.) Maximum commutation frequency (f _{MAX}): cycles per second equivalent to an electrical degree H or open: f _{MAX} ≈ f _{osc} /3 × 2 ¹¹ Example: f _{MAX} ≈ 0.8 kHz @ f _{osc} = 5 MHz L: f _{MAX} ≈ f _{osc} /3 × 2 ¹² Example: f _{MAX} ≈ 0.4 kHz @ f _{osc} = 5 MHz
8	SEL_LAP	I	Overlapping commutation select pin (This pin has a pull-up resistor.) H or open: 120° commutation L: Overlapping commutation
9	IR1	O	Connection pins for an output shunt resistor (IR1 and IR2 are connected together inside the IC. However, IR3 is not connected to IR1 or IR2 inside the IC; these three pins must be connected together externally.)
10	IR2		
11	N.C.	—	No connect
12	W	O	W-phase output
13	PGND	—	Power ground pin
14	OC	I	Overcurrent detection input (This pin has a pull-down resistor.) All PWM output signals are stopped when OC ≥ 0.5 V (typ.).
15	WAVEP	I	Positive (+) position signal input
16	WAVEM	I	Negative (-) position signal input
17	VM2	—	Motor power supply pin (VM = 7 to 42 V). VM1, VM2 and VM3 are connected together inside the IC.
18	SGND1	—	Signal ground pin (SGND1 and SGND2 are connected together inside the IC.)
19	SGND2		
20	WAVE	O	Position signal output Provides a majority of the voltages of the three phase signals.
21	VREF	O	Reference voltage output; V _{REF} = 5 V (typ.)
22	VSP	I	Duty cycle/motor speed control input (This pin has a pull-down resistor.) 0 ≤ V _{SP} < V _{AD} (L): Duty = 0% V _{AD} (L) ≤ V _{SP} ≤ V _{AD} (H): Sets the PWM duty cycle, based on the analog input. V _{AD} (H) < V _{SP} ≤ V _{REF} : ≈100 % duty cycle (127/128)
23	SC	I	Connection pin for a capacitor to set the startup commutation time and the ramp-up time for the on state.
24	START	O	DC excitation time setting pins When V _{SP} ≥ 1 V (typ.), START is driven low, starting DC excitation. When the IP voltage has reached V _{REF} /2, the TB6588FG switches to forced commutation mode.
25	IP	I	
26	OSC_C	—	OSC_C: Connection pins for the oscillator capacitor OSC_R: Connection pins for the oscillator resistor Example: Internal oscillating frequency (f _{osc}) ≈ 5.25 MHz (typ.) when OSC_C = 100 pF and OSC_R = 20 kΩ
27	OSC_R		
28	IR3	O	Connection pin for an output shunt resistor (IR1 and IR2 are connected together inside the IC. However, IR3 is not connected to IR1 or IR2 inside the IC; these three pins must be connected together externally.)

Pin No.	Symbol	I/O	Description
29	FG_OUT	O	Rotation speed output pin (open-drain) This output is held low at startup and when an abnormality is detected. In sensorless mode, pulses are generated at 3 ppr according to the back-EMF. Note: 3 ppr ;3 pulses per electrical degree (With a four-pole motor, six pulses are generated per revolution.)
30	FST2	I	Forced commutation frequency select inputs (These pins have a pull-down resistor.) Forced commutation frequency: cycles per second equivalent to an electrical degree FST2: FST1 = H: H: $f_{ST} \approx f_{osc}/(6 \times 2^{16}) \rightarrow 12.7 \text{ Hz @ } f_{osc} = 5 \text{ MHz}$ FST2: FST1 = H: L or Open: $f_{ST} \approx f_{osc}/(6 \times 2^{17}) \rightarrow 6.4 \text{ Hz @ } f_{osc} = 5 \text{ MHz}$ FST2: FST1 = L or Open: H: $f_{ST} \approx f_{osc}/(6 \times 2^{18}) \rightarrow 3.2 \text{ Hz @ } f_{osc} = 5 \text{ MHz}$ FST2: FST1 = L or Open: L or Open: $f_{ST} \approx f_{osc}/(6 \times 2^{19}) \rightarrow 1.6 \text{ Hz @ } f_{osc} = 5 \text{ MHz}$
31	FST1		
32	FPWM	I	PWM frequency (f_{PWM}) select input (This pin has a pull-down resistor.) H: $f_{PWM} \approx f_{osc}/128 \rightarrow f_{PWM} \approx 39 \text{ kHz @ } f_{osc} = 5 \text{ MHz}$ L or Open: $f_{PWM} \approx f_{osc}/256 \rightarrow f_{PWM} \approx 19.5 \text{ kHz @ } f_{osc} = 5 \text{ MHz}$
33	LA2	I	Lead angle select input (These pins have a pull-up resistor.) LA2: LA1 = H or Open : H or Open : 30° lead angle LA2: LA1 = H or Open : L : 15° lead angle LA2: LA1 = L : H or Open : 7.5° lead angle LA2: LA1 = L : L : 0° lead angle
34	LA1		
35	N.C.	—	No connect
36	VM3	—	Motor power supply pin (VM = 7 to 42 V). VM1, VM2 and VM3 are connected together inside the IC.
Fin	Fin	—	Fin This pin provides for thermal dissipation. Board traces should be designed, considering thermal dissipation from the IC. (Since the fin and the package bottom are electrically connected, the Fin pin should be connected to insulation or ground.)

Not Recommended for New Design

Functional Description

1. Sensorless Drive Mode

Based on the analog voltage input for a startup operation, the rotor is aligned to a known position in DC excitation mode. Then the forced commutation signal is generated to start the motor rotation. As the motor rotates, the back-EMF occurs in each phase of the coil.

When a signal indicating the polarity of three phase voltage of the motor, including the back-EMF, is detected at the position signal inputs (WAVEP, WAVEM), the motor driving signal is automatically switched from the forced commutation PWM signal to the normal commutation PWM signal that is based on the position signal input (back-EMF). Then, a BLDC motor starts running in sensorless commutation mode.

2. Startup Operation

At startup, no induced voltage is generated due to the stationary motor, and the rotor position cannot be detected in sensorless mode. Therefore, the TB6588FG rotor is first aligned to a known position in DC excitation mode for an appropriate period of time, and then the motor is started in forced commutation mode. The DC excitation and forced commutation times are determined by external capacitors. These time settings vary depending on the motor type and load, so that they should be adjusted experimentally.

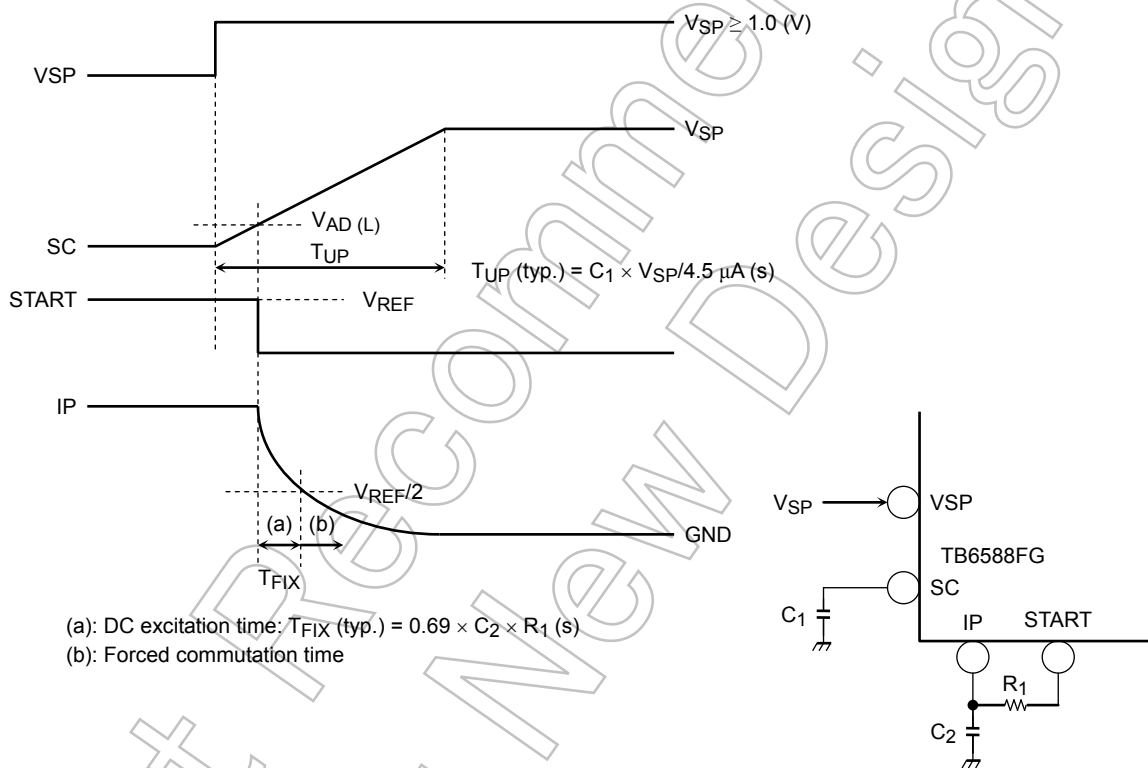

The rotor is aligned to a known position specified in DC excitation mode for the period of (a), during which the IP pin voltage decreases from VREF to VREF/2. The time constant for the period is determined by C2 and R1. Then, operation mode is switched to forced commutation mode for the period of (b) as shown above. The duty cycles for DC excitation and forced commutation modes are determined according to the SC pin voltage. When the motor rotation frequency exceeds the forced commutation frequency specified by FST1 and FST2, the operation mode is switched to the sensorless mode. The duty cycle for sensorless mode is determined by VSP.

3. SC Signal Delay in Rotational Speed Control (V_{SP} follow-up property of SC)

The rotational speed and the starting and stopping of the motor are controlled based on an analog voltage at the V_{SP} input. However, the actual operation of the IC is determined by the voltage applied to the SC pin. The voltage at the SC pin equals the charging voltage of the capacitor C_1 , which is determined by the charging/discharging time of C_1 . This causes a delay in the SC voltage level relative to the V_{SP} input. When the voltage at the V_{SP} pin rises from 1 to 4 V, the SC signal delay occurs as shown below.

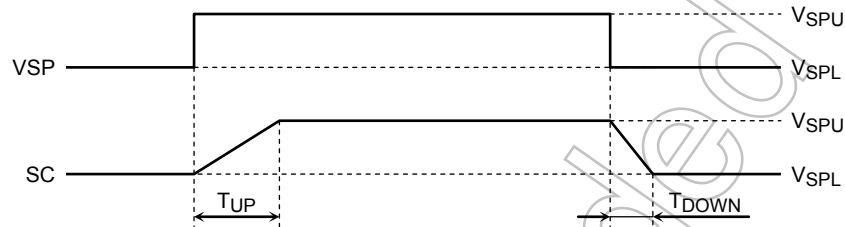

- Charging time of C_1 (when accelerating): $T_{UP} (typ.) = C_1 \times (V_{SPU} - V_{SPL}) / 4.5 \mu A (s)$
- Discharging time of C_1 (when decelerating): $T_{DOWN} (typ.) = C_1 \times (V_{SPU} - V_{SPL}) / 37 \mu A (s)$

Note: When the motor is stopped ($V_{SP} < 1 V$), the capacitor C_1 at the SC pin is instantly discharged. (The C_1 is discharged through $2 k\Omega$ (typ.) to GND.)

4. Forced Commutation Frequency

The forced commutation frequency at startup is determined as follows.

Since the optimal frequency varies depending on the motor type and load, it must be adjusted experimentally.

The forced commutation frequency is determined by the value of external capacitor and resistor, and the logic level of the FST1 and FST2 pins (These pins have a pull-down resistor).

FST2: FST1 = High	: High	: Forced commutation frequency $f_{ST} \approx f_{osc} / (6 \times 2^{16})$
FST2: FST1 = High	: Low or Open	: Forced commutation frequency $f_{ST} \approx f_{osc} / (6 \times 2^{17})$
FST2: FST1 = Low or Open	: High	: Forced commutation frequency $f_{ST} \approx f_{osc} / (6 \times 2^{18})$
FST2: FST1 = Low or Open	: Low or Open	: Forced commutation frequency $f_{ST} \approx f_{osc} / (6 \times 2^{19})$

5. PWM Frequency

The PWM frequency is determined by the value of the external capacitor and resistor, and the logic level of the FPWM pin (which has a pull-down resistor).

FPWM: High	: $f_{PWM} = f_{osc} / 128$
FPWM: Low or Open	: $f_{PWM} = f_{osc} / 256$

The PWM frequency must be sufficiently high relative to the electrical frequency of the motor and within the range permitted by the driver circuit.

The PWM turn the high-side output transistors off.

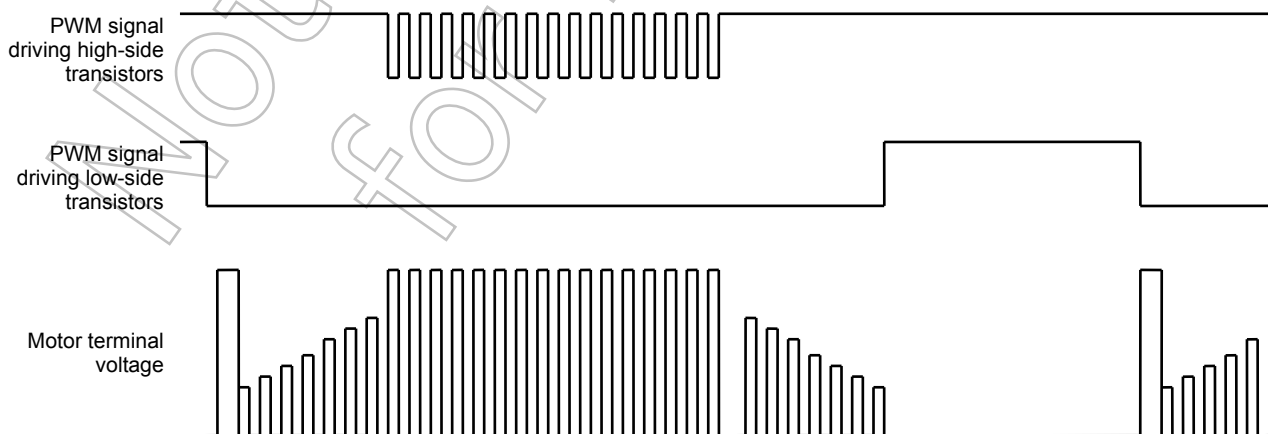

6. Motor Speed Control Pin (VSP)

An analog voltage applied to the VSP pin is converted by a 7-bit AD converter and used to control the duty cycle of the PWM.

$0 \leq V_{SP} < V_{AD(L)} \rightarrow$ Duty cycle = 0 %

$V_{AD(L)} \leq V_{SP} \leq V_{AD(H)} \rightarrow$ Figure on the right (1/128 to 127/128)

$V_{AD(H)} < V_{SP} \leq V_{REF} \rightarrow$ Duty cycle \approx 100 % (127/128)

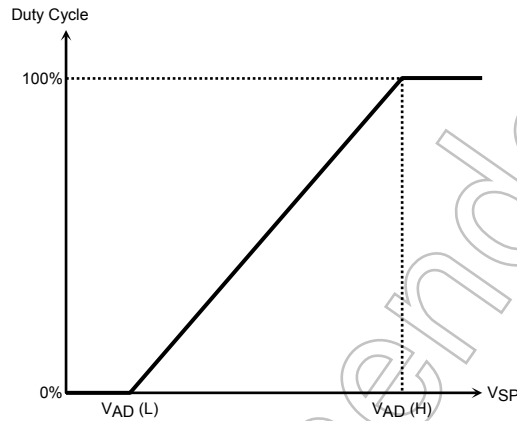

7. Fault Protection Operation

The logic level of the EN pin determines whether to enable the protection functionality. (The EN pin has a pull-up resistor.)

H or Open : Protection functionality enabled

L : Protection functionality disabled

When a behavior as shown below is detected via the WAVEP and WAVEM pins, as the motor is deemed to be in an abnormal state and the output transistors are turned off. About one second later, the motor is restarted. The device begins cycling into and out of the protection mode if the abnormality persists.

- The maximum commutation frequency is exceeded.
- The rotation speed falls below the forced commutation frequency.

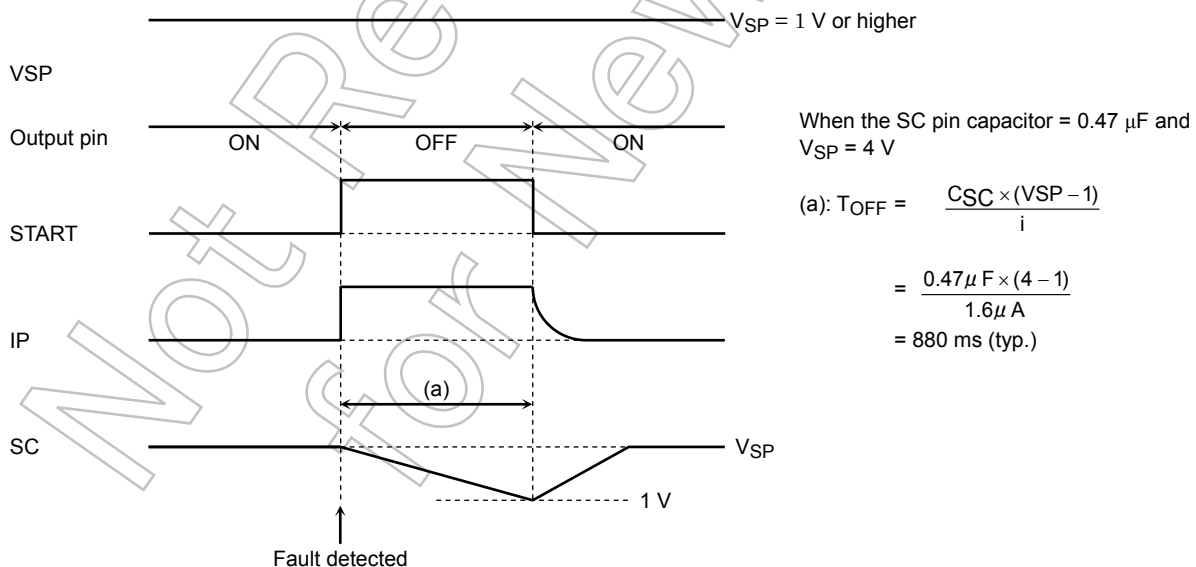

8. Motor Position Detection Error

The position detection is performed synchronizing with the PWM signal generated in the IC. Thus, a position detection error related to the PWM signal frequency is induced. Care should be taken when the TB6588FG is used in high-speed motor applications.

The detection is performed on the falling edge of the PWM signal. An error is recognized when the terminal voltage exceeds the reference voltage.

$$\text{Detection lag} < 1/f_p \quad f_p: \text{PWM frequency} = f_{osc}/256, f_{osc}/128 \quad f_{osc}: \text{Internal oscillating frequency}$$

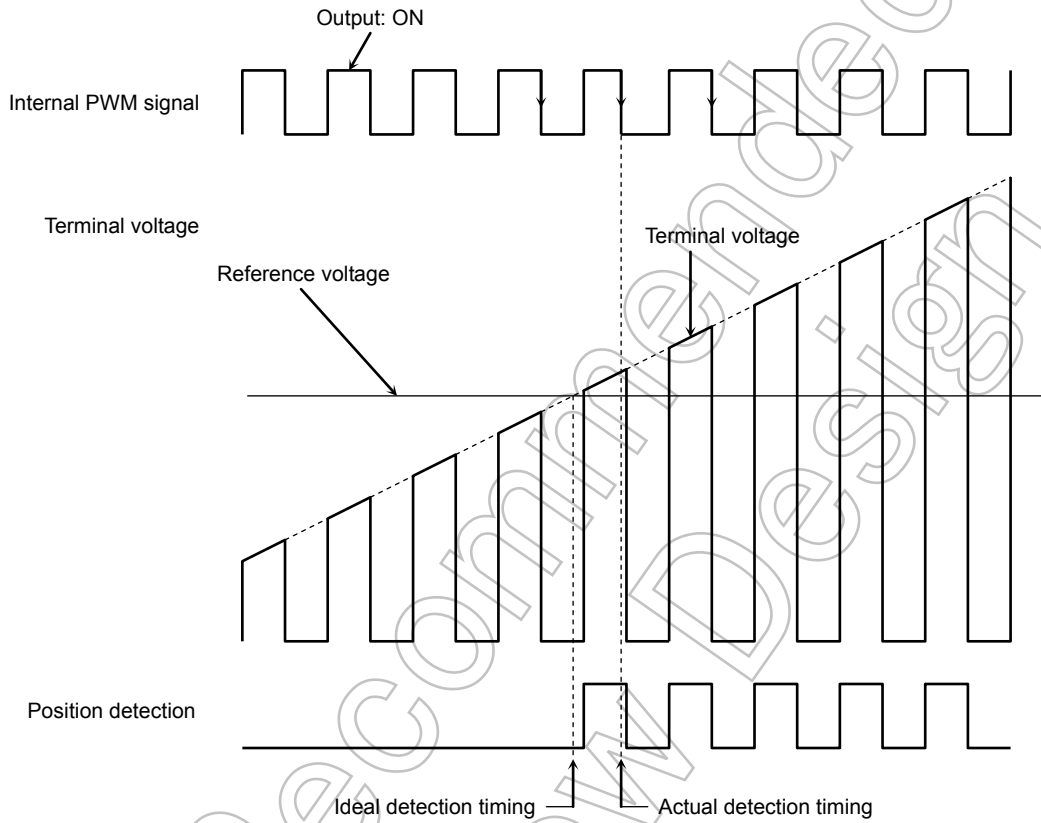

9. Lead Angle Control

The TB6588FG runs in forced commutation mode with a lead angle of 0° at startup. After switching to normal commutation mode, the lead angle is automatically changed to the value set by the LA1 and LA2 pins.

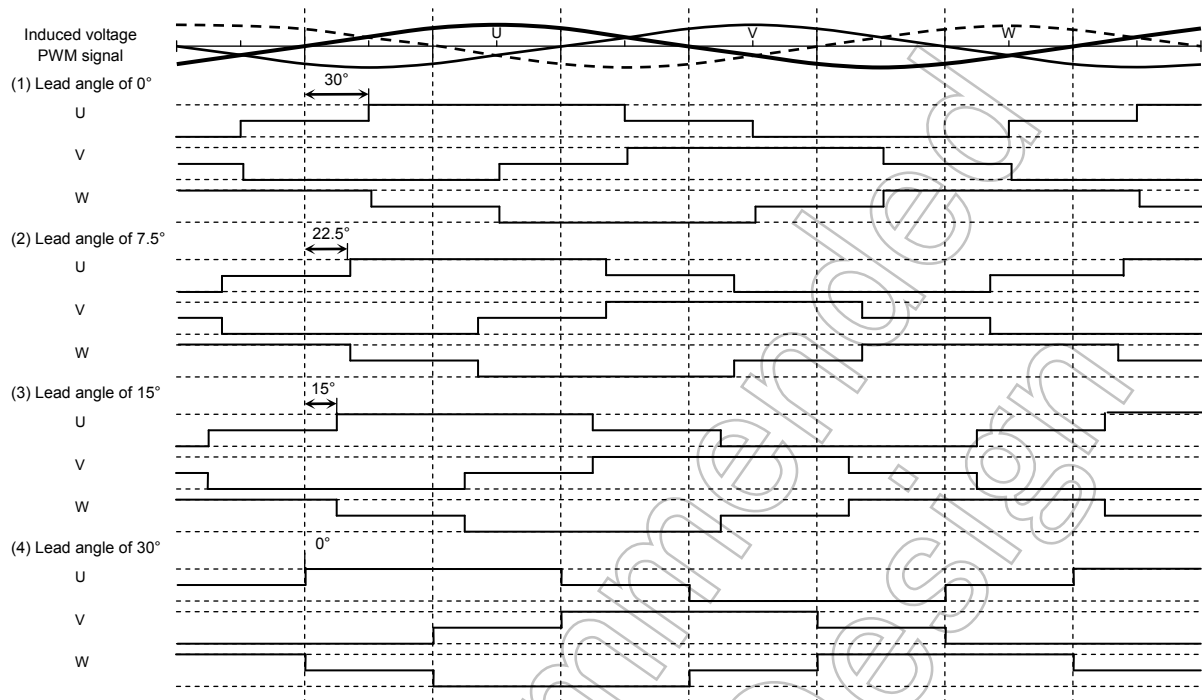

10. Overlapping Commutation Control

When SEL_LAP = High, the TB6588FG runs in 120° commutation mode. When SEL_LAP = Low, it runs in overlapping commutation mode. In overlapping commutation mode, there occurs an overlapping period due to the lengthened commutation time between the zero cross point and the 120° commutation timing upon PWM signal switching as shown in the shaded areas. These periods vary depending on the lead angle setting.

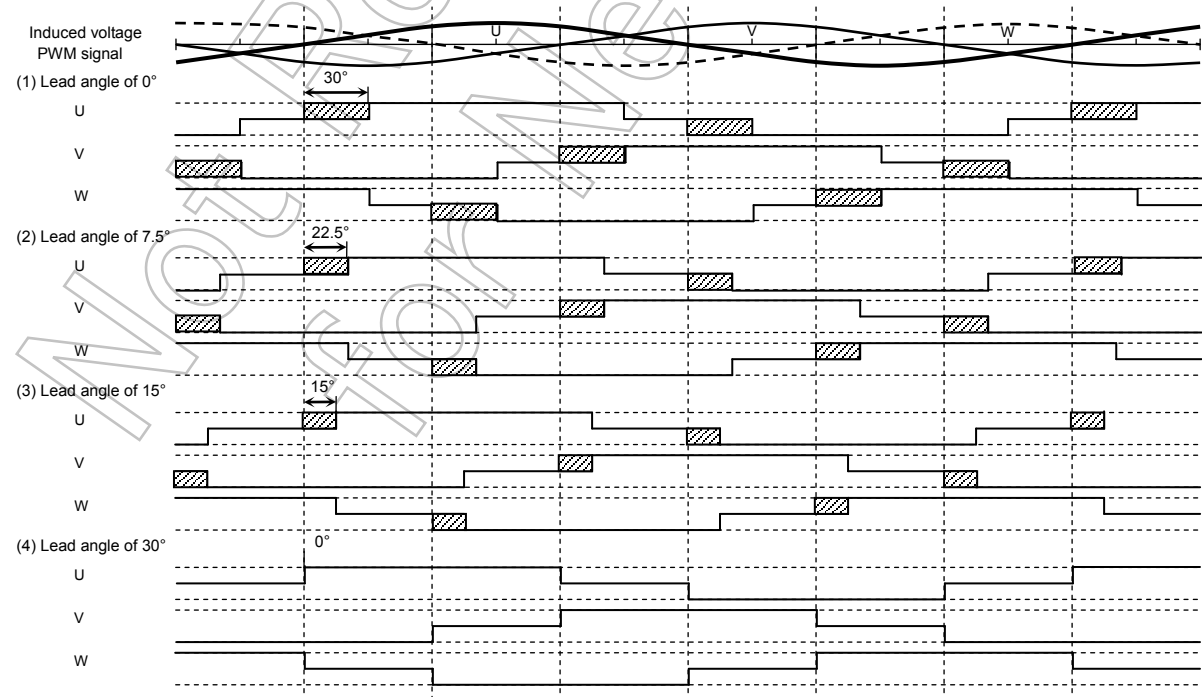

11. Thermal Shutdown (TSD) Circuit (Note)

When the die temperature exceeds the rated TSD temperature, the TSD circuit detects it as the abnormal state of the motor and the output transistors are turned off.

At the same time, START and SC are set High and Low respectively.

After the TSD circuit is disabled, the TB6588FG restarts its operation following the startup sequence.

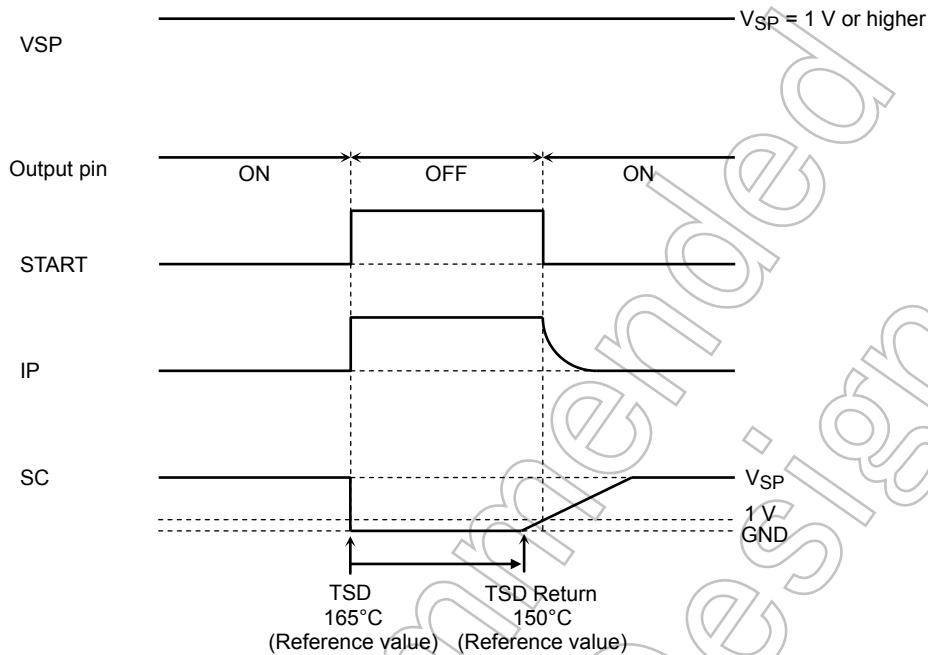

Note: The TSD circuit is not intended to provide protection against all abnormal conditions. Therefore, the TB6588FG should exit the abnormal state immediately after the TSD circuit is enabled.

If the device is used beyond the absolute maximum ratings, the TSD circuit may not operate properly, or the device may break down before the protection circuit is activated.

Also, if the motor keeps running due to inertia after the TSD circuit is activated, the startup sequence may lose synchronization with the motor rotation, which may prevent the motor from restarting after the TSD circuit is disabled.

Thus, for a restart operation after the TSD circuit operation, it should be ensured that the motor be stopped once before being restarted.

12. Overcurrent Protection Circuit (Note)

The overcurrent protection circuit limits the current by turning the high-side output transistors off. The output current is monitored as a voltage across R₁. If it exceeds the rated V_{OC} voltage (0.5 V (typ.)), the protection functionality is enabled.

The current value that trips the overcurrent protection circuit is calculated as:

$$I_{OUT} = \text{Overcurrent detection voltage } V_{OC} / \text{Resistor value } R_1$$

R₂ and C₂ used as an RC filter should be adjusted properly to prevent the malfunction of the overcurrent protection circuit due to the PWM switching noise.

Example: When R₁ = 0.33 [Ω], I_{OUT} (typ.) = 0.5 [V] (typ.)/0.33 [Ω] ≈ 1.5 [A]

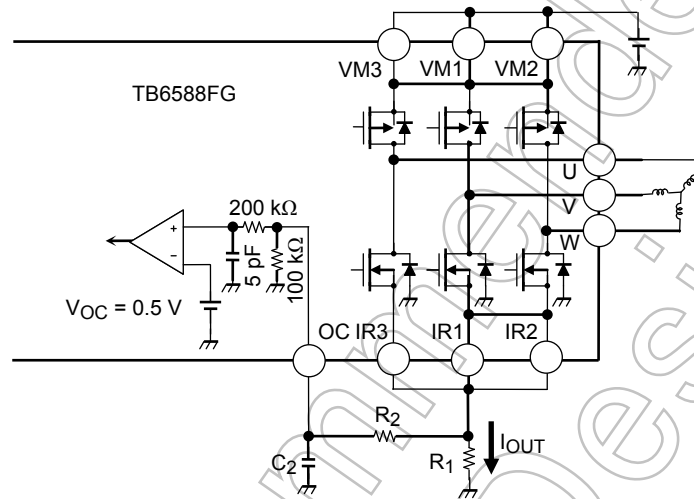

Note: The overcurrent protection circuit (normally a current limiter) is not intended to provide protection against all abnormal conditions. Therefore, the TB6588FG should exit the abnormal state immediately after the overcurrent protection circuit is enabled.

If the device is used beyond the absolute maximum ratings, the overcurrent protection circuit may not operate properly, or the device may break down before the protection circuit is activated.

Also, if the overcurrent still persists after the protection circuit is activated, the device may be destroyed due to overheating.

If the overcurrent protection circuit remains active, the timing of the position detection that is performed synchronously with the PWM signal changes. Thus, the motor may lose synchronization. Therefore, the overcurrent protection circuit must be configured not to operate under normal operation.

Input Equivalent Circuits

Some parts are omitted from the equivalent circuit diagrams or simplified for the sake of simplicity.

1. VSP

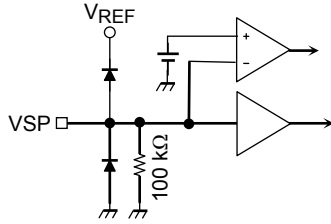

2. SC

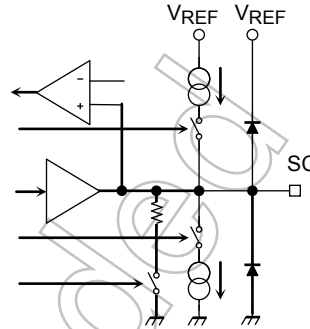

3. FPWM, FST1, FST2

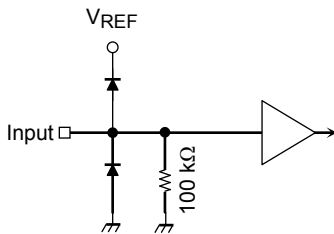

4. CW_CCW, LA1, LA2, FMAX, SEL_LAP, EN

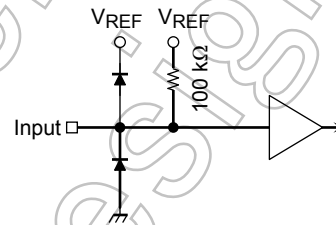

5. WAVE, WAVEM, WAVEP

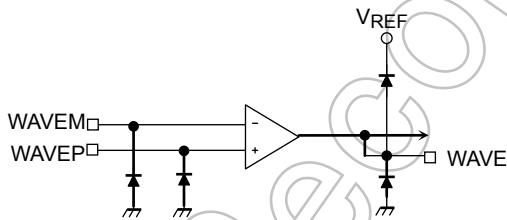

6. OC

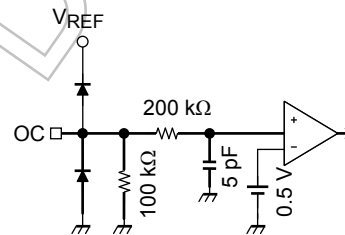

7. FG_OUT

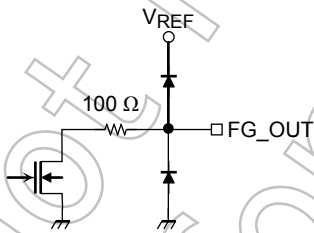

8. U, V, W

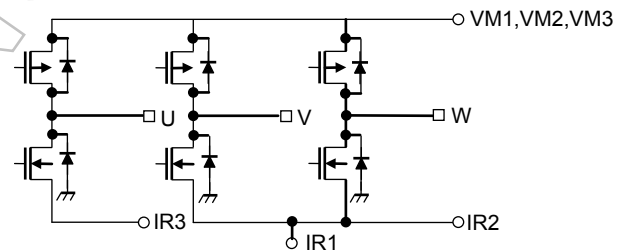

9. IP

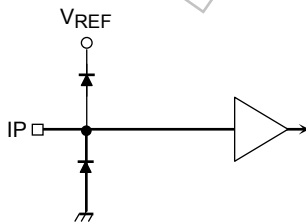

10. START

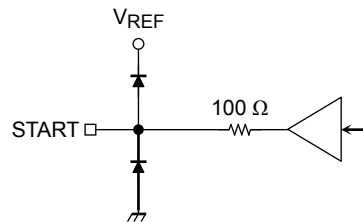

11. OSC_R, OSC_C

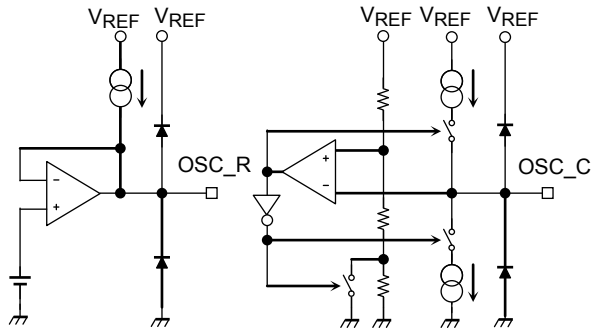

12. VREF

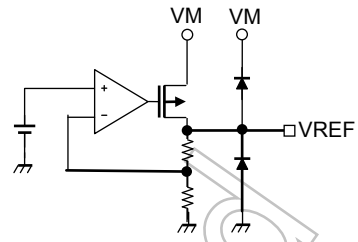

Not Recommended for New Design

Absolute Maximum Ratings (Ta = 25°C)

Characteristics	Symbol	Rating	Unit
Power supply voltage	VM	50	V
Input voltage	V _{IN1} (Note 1)	-0.3 to V _{REF} + 0.3	V
	V _{IN2} (Note 2)	-0.3 to 30	
PWM signal output current	I _{OUT}	2.5 (Note 3)	A
Power dissipation	P _D	1.3 (Note 4)	W
		3.2 (Note 5)	
Operating temperature	T _{opr}	-30 to 105	°C
Storage temperature	T _{stg}	-55 to 150	°C

Note 1: V_{IN1} is applicable to the voltage at the following pins: FPWN, FMAX, VSP, CW_CCW, LA1, LA2, OC, SEL_LAP, FST1, FST2 and EN

Note 2: V_{IN2} is applicable to the voltage at the following pins: WAVEP, WAVEM

Note 3: Output current may be limited by the ambient temperature or a heatsink. The maximum junction temperature should not exceed T_{jmax} = 150°C.

Note 4: Measured for the IC only. (Ta = 25°C)

Note 5: Measured when mounted on the board. (140 mm × 70 mm × 1.6 mm, Cu 50 %, R_{th(j-a)}: 39°C/W)

Operating Ranges (Ta = -30 to 105°C)

Characteristics	Symbol	Min	Typ.	Max	Unit
Power supply voltage	VM	7	24	42	V
Input voltage	V _{IN1} (Note 1)	GND	—	V _{REF}	V

Package Power Dissipation

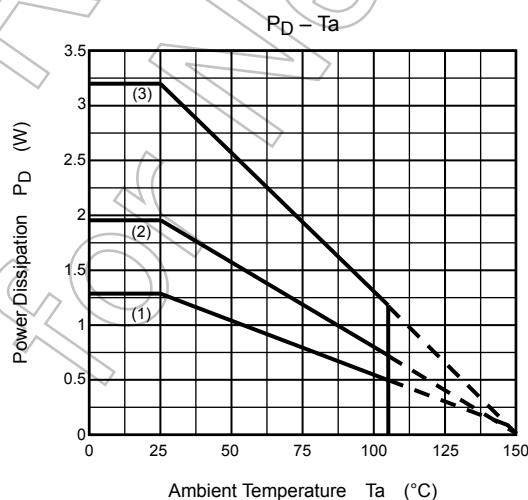

- (1) R_{th(j-a)} only (96°C/W)
- (2) When mounted on the board (114 mm × 75 mm × 1.6 mm, Cu 20%, R_{th(j-a)}: 65°C/W)
- (3) When mounted on the board (140 mm × 70 mm × 1.6 mm, Cu 50%, R_{th(j-a)}: 39°C/W)

Electrical Characteristics (Ta = 25 °C, VM = 24 V, unless otherwise specified)

Characteristics	Symbol	Test Conditions	Min	Typ.	Max	Unit
Static power supply current at VM	IM	VSP = 0 V, OSC_C = 0 V	—	3.5	6	mA
Dynamic power supply current at VM	IM (opr)	VSP = 2.5 V, Output: Open (OSC_C = 100 pF, OSC_R = 20 kΩ)	—	4.5	8	mA
Input current	IIN-1 (H)	VIN = VREF, SEL_LAP, FMAX CW_CCW, LA1, LA2, EN	—	0	1	μA
	IIN-1 (L)	VIN = 0 V, SEL_LAP, FMAX CW_CCW, LA1, LA2, EN	-75	-50	—	
	IIN-2 (H)	VIN = VREF, OC, FST1, FST2, FPWM	—	50	75	
	IIN-2 (L)	VIN = 0 V, OC, FST1, FST2, FPWM	-1	0	—	
	IIN-3 (H)	VIN = VREF, VSP	—	90	150	
	IIN-3 (L)	VIN = 0 V, VSP	-1	0	—	
	IIN-4 (H)	WAVEM; WAVEM = VM/2, WAVEP = 0 V WAVEP; WAVEM = VM/2, WAVEP = VM	—	0	0.25	
IIN-4 (L)	WAVEM; WAVEM = VM/2, WAVEP = VM WAVEP; WAVEM = VM/2, WAVEP = 0 V	-0.25	-0.1	—		
Input offset voltage	VINO	WAVE; WAVEP - WAVEM	-6	4	14	mV
Input voltage	VIN-1 (H)	SEL_LAP, CW_CCW, LA1, LA2, FMAX, FST1, FST2, EN, FPWM	3.5	—	VREF	V
	VIN-1 (L)	SEL_LAP, CW_CCW, LA1, LA2, FMAX, FST1, FST2, EN, FPWM	GND	—	1.5	
Input voltage hysteresis	VH	IP	—	0.45	—	V
Low-level FG_OUT output voltage	VFG_OUT	I _{FG_OUT} = 1 mA	GND	—	0.5	V
FG_OUT leakage current	ILFG_OUT	VFG_OUT = 5.5 V	—	0	10	μA
Output ON-resistance	RON (H)	I _{OUT} = 1.5 A U, V, W	—	0.3	0.35	Ω
	RON (L)	I _{OUT} = -1.5 A U, V, W	—	0.3	0.35	
Output leakage current	IL (H)	V _{OUT} = 0 V U, V, W	—	0	1	μA
	IL (L)	V _{OUT} = 50 V U, V, W	—	0	1	
PWM input voltage	VAD (L)	VSP FPWM = L (OSC_C = 100 pF, OSC_R = 20 kΩ)	1.0	1.2	1.4	V
	VAD (H)		3.9	4.1	4.3	
C _{SC} charge current	ISC	SC VSP = 2.5 V	3.0	4.5	6.5	μA
Fault recovery time	T _{OFF}	VSP = 4 V, SC pin = 0.47 μF	—	880	—	ms
Overcurrent detection voltage	VOC	OC	0.46	0.5	0.54	V
PWM frequency	Fc H	FPWM = H (OSC_C = 100 pF, OSC_R = 20 kΩ)	36	40	44	kHz
	Fc-L	FPWM = L (OSC_C = 100 pF, OSC_R = 20 kΩ)	18	20	22	
Thermal shutdown	TSD	Thermal shutdown temperature (Design target only.)	150	165	180	°C
	TSDhys	Thermal shutdown hysteresis (Design target only.)	—	15	—	
VREF output voltage	VREF	I _{VREF} = -1 mA	4.5	5	5.5	V

Application Circuit Example

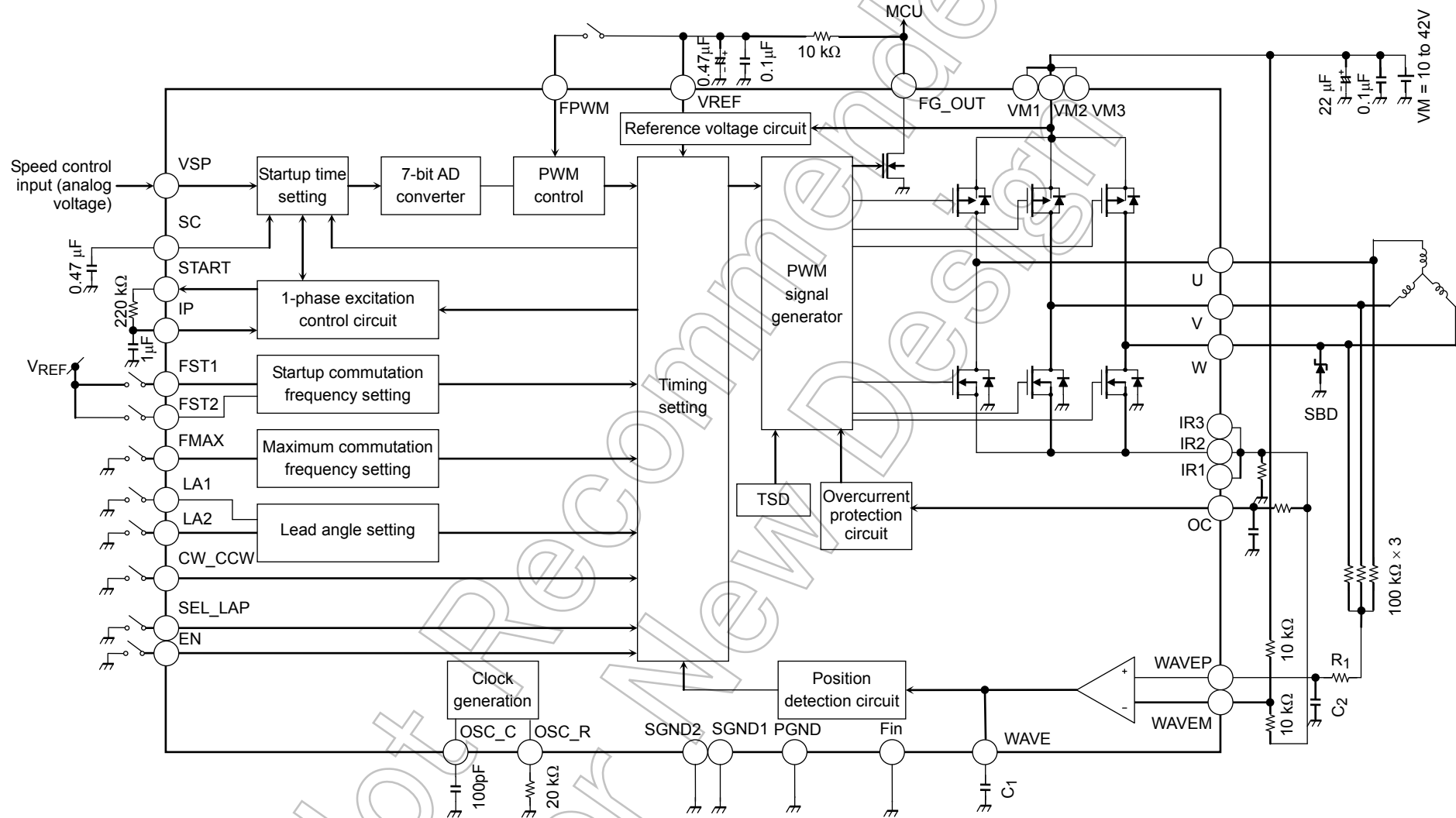

Note 1: Utmost care is necessary in the design of the output, VM, and GND lines since the IC may be destroyed in case of a short-circuit across outputs, a short-circuit to power supply, or a short-circuit to ground.

Note 2: The above application circuit including constant values is provided only as a guide. Since each value may vary depending on the motor type, the optimal values must be determined experimentally.

Note 3: C₁, C₂ and R₁ should be connected, if necessary, to prevent malfunction due to noise.

Note 4: A Schottky barrier diode (SBD; Toshiba Electronic Devices & Storage CMS15) must be connected externally between W and GND to ensure smooth current recovery upon output switching.

Package Dimensions

HSOP36-P-450-0.65

Unit: mm

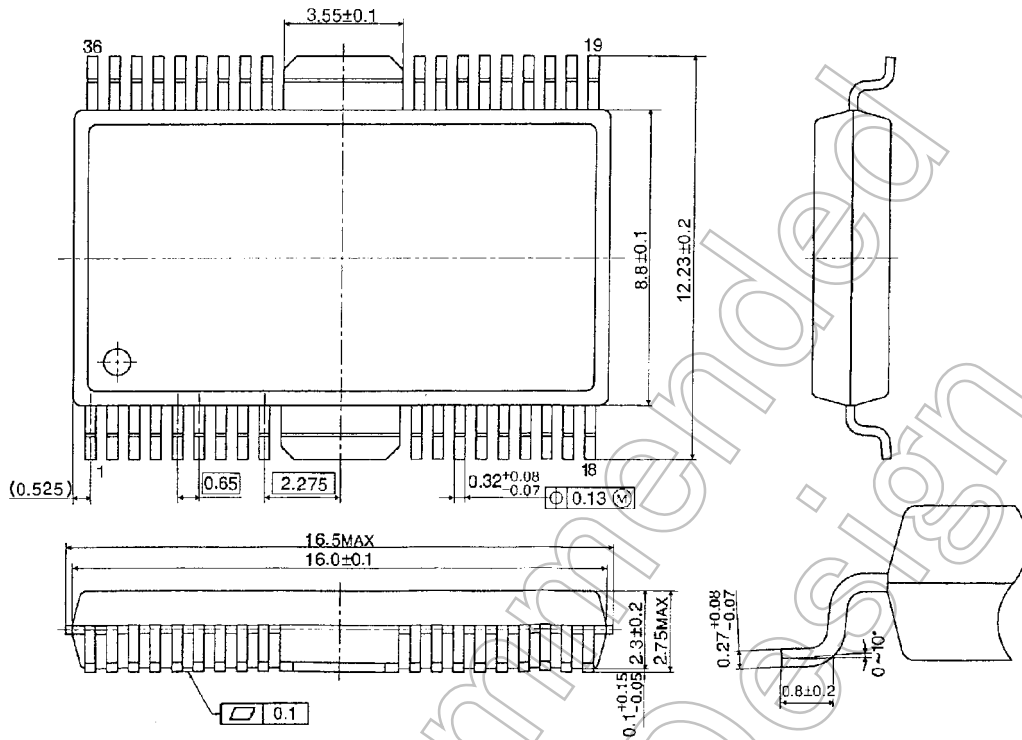

Weight: 0.79 g (typ.)

Not Recommended for New Design

Notes on Contents

1. Block Diagrams

Some of the functional blocks, circuits, or constants in the block diagram may be omitted or simplified for explanatory purposes.

2. Equivalent Circuits

The equivalent circuit diagrams may be simplified or some parts of them may be omitted for explanatory purposes.

3. Timing Charts

Timing charts may be simplified for explanatory purposes.

4. Application Circuits

The application circuits shown in this document are provided for reference purposes only. Thorough evaluation is required, especially at the mass production design stage.

Providing these application circuit examples does not grant a license for industrial property rights.

5. Test Circuits

Components in the test circuits are used only to obtain and confirm the device characteristics. These components and circuits are not guaranteed to prevent malfunction or failure from occurring in the application equipment.

IC Usage Considerations

Notes on handling of ICs

- (1) The absolute maximum ratings of a semiconductor device are a set of ratings that must not be exceeded, even for a moment. Do not exceed any of these ratings.
Exceeding the rating(s) may cause the device breakdown, damage or deterioration, and may result injury by explosion or combustion.
- (2) Use an appropriate power supply fuse to ensure that a large current does not continuously flow in case of over current and/or IC failure. The IC will fully break down when used under conditions that exceed its absolute maximum ratings, when the wiring is routed improperly or when an abnormal pulse noise occurs from the wiring or load, causing a large current to continuously flow and the breakdown can lead smoke or ignition. To minimize the effects of the flow of a large current in case of breakdown, appropriate settings, such as fuse capacity, fusing time and insertion circuit location, are required.
- (3) If your design includes an inductive load such as a motor coil, incorporate a protection circuit into the design to prevent device malfunction or breakdown caused by the current resulting from the inrush current at power ON or the negative current resulting from the back electromotive force at power OFF. IC breakdown may cause injury, smoke or ignition.
Use a stable power supply with ICs with built-in protection functions. If the power supply is unstable, the protection function may not operate, causing IC breakdown. IC breakdown may cause injury, smoke or ignition.
- (4) Do not insert devices in the wrong orientation or incorrectly.
Make sure that the positive and negative terminals of power supplies are connected properly. Otherwise, the current or power consumption may exceed the absolute maximum rating, and exceeding the rating(s) may cause the device breakdown, damage or deterioration, and may result injury by explosion or combustion.
In addition, do not use any device that is applied the current with inserting in the wrong orientation or incorrectly even just one time.

Points to Remember on Handling of ICs

- (1) **Over current protection circuit**

Over current protection circuits (referred to as current limiter circuits) do not necessarily protect ICs under all circumstances. If the Over current protection circuits operate against the over current, clear the over current status immediately.

Depending on the method of use and usage conditions, such as exceeding absolute maximum ratings can cause the over current protection circuit to not operate properly or IC breakdown before operation. In addition, depending on the method of use and usage conditions, if over current continues to flow for a long time after operation, the IC may generate heat resulting in breakdown.
- (2) **Thermal shutdown circuit**

Thermal shutdown circuits do not necessarily protect ICs under all circumstances. If the thermal shutdown circuits operate against the over temperature, clear the heat generation status immediately. Depending on the method of use and usage conditions, such as exceeding absolute maximum ratings can cause the thermal shutdown circuit to not operate properly or IC breakdown before operation.
- (3) **Heat radiation design**

In using an IC with large current flow such as power amp, regulator or driver, please design the device so that heat is appropriately radiated, not to exceed the specified junction temperature (T_J) at any time and condition. These ICs generate heat even during normal use. An inadequate IC heat radiation design can lead to decrease in IC life, deterioration of IC characteristics or IC breakdown. In addition, please design the device taking into consideration the effect of IC heat radiation with peripheral components.
- (4) **Back-EMF**

When a motor rotates in the reverse direction, stops or slows down abruptly, a current flow back to the motor's power supply due to the effect of back-EMF. If the current sink capability of the power supply is small, the device's motor power supply and output pins might be exposed to conditions beyond absolute maximum ratings. To avoid this problem, take the effect of back-EMF into consideration in system design.
- (5) **Damage due to Short-Circuits Between Neighboring Pin**

Short-circuits between pins 1 and 2, pins 3 and 4 and pins 12 and 13 cause permanent damage to the TB6588FG. As a result, a large current continuously flow into the device, leading to smoke and possibly fire. To avoid this, the device application should be designed and adjusted properly, including the external fail-safe mechanism, such as power supply fuses and overcurrent protection circuitry for power supply. To minimize the effect of such a current flow in case of damage, ensure that the fuse capacity, fusing time and overcurrent protection circuitry are properly adjusted.

RESTRICTIONS ON PRODUCT USE

Toshiba Corporation and its subsidiaries and affiliates are collectively referred to as "TOSHIBA". Hardware, software and systems described in this document are collectively referred to as "Product".

- TOSHIBA reserves the right to make changes to the information in this document and related Product without notice.
- This document and any information herein may not be reproduced without prior written permission from TOSHIBA. Even with TOSHIBA's written permission, reproduction is permissible only if reproduction is without alteration/omission.
- Though TOSHIBA works continually to improve Product's quality and reliability, Product can malfunction or fail. Customers are responsible for complying with safety standards and for providing adequate designs and safeguards for their hardware, software and systems which minimize risk and avoid situations in which a malfunction or failure of Product could cause loss of human life, bodily injury or damage to property, including data loss or corruption. Before customers use the Product, create designs including the Product, or incorporate the Product into their own applications, customers must also refer to and comply with (a) the latest versions of all relevant TOSHIBA information, including without limitation, this document, the specifications, the data sheets and application notes for Product and the precautions and conditions set forth in the "TOSHIBA Semiconductor Reliability Handbook" and (b) the instructions for the application with which the Product will be used with or for. Customers are solely responsible for all aspects of their own product design or applications, including but not limited to (a) determining the appropriateness of the use of this Product in such design or applications; (b) evaluating and determining the applicability of any information contained in this document, or in charts, diagrams, programs, algorithms, sample application circuits, or any other referenced documents; and (c) validating all operating parameters for such designs and applications. **TOSHIBA ASSUMES NO LIABILITY FOR CUSTOMERS' PRODUCT DESIGN OR APPLICATIONS.**
- **PRODUCT IS NEITHER INTENDED NOR WARRANTED FOR USE IN EQUIPMENTS OR SYSTEMS THAT REQUIRE EXTRAORDINARILY HIGH LEVELS OF QUALITY AND/OR RELIABILITY, AND/OR A MALFUNCTION OR FAILURE OF WHICH MAY CAUSE LOSS OF HUMAN LIFE, BODILY INJURY, SERIOUS PROPERTY DAMAGE AND/OR SERIOUS PUBLIC IMPACT ("UNINTENDED USE").** Except for specific applications as expressly stated in this document, Unintended Use includes, without limitation, equipment used in nuclear facilities, equipment used in the aerospace industry, medical equipment, equipment used for automobiles, trains, ships and other transportation, traffic signaling equipment, equipment used to control combustions or explosions, safety devices, elevators and escalators, devices related to electric power, and equipment used in finance-related fields. **IF YOU USE PRODUCT FOR UNINTENDED USE, TOSHIBA ASSUMES NO LIABILITY FOR PRODUCT.** For details, please contact your TOSHIBA sales representative.
- Do not disassemble, analyze, reverse-engineer, alter, modify, translate or copy Product, whether in whole or in part.
- Product shall not be used for or incorporated into any products or systems whose manufacture, use, or sale is prohibited under any applicable laws or regulations.
- The information contained herein is presented only as guidance for Product use. No responsibility is assumed by TOSHIBA for any infringement of patents or any other intellectual property rights of third parties that may result from the use of Product. No license to any intellectual property right is granted by this document, whether express or implied, by estoppel or otherwise.
- **ABSENT A WRITTEN SIGNED AGREEMENT, EXCEPT AS PROVIDED IN THE RELEVANT TERMS AND CONDITIONS OF SALE FOR PRODUCT, AND TO THE MAXIMUM EXTENT ALLOWABLE BY LAW, TOSHIBA (1) ASSUMES NO LIABILITY WHATSOEVER, INCLUDING WITHOUT LIMITATION, INDIRECT, CONSEQUENTIAL, SPECIAL, OR INCIDENTAL DAMAGES OR LOSS, INCLUDING WITHOUT LIMITATION, LOSS OF PROFITS, LOSS OF OPPORTUNITIES, BUSINESS INTERRUPTION AND LOSS OF DATA, AND (2) DISCLAIMS ANY AND ALL EXPRESS OR IMPLIED WARRANTIES AND CONDITIONS RELATED TO SALE, USE OF PRODUCT, OR INFORMATION, INCLUDING WARRANTIES OR CONDITIONS OF MERCHANTABILITY, FITNESS FOR A PARTICULAR PURPOSE, ACCURACY OF INFORMATION, OR NONINFRINGEMENT.**
- Do not use or otherwise make available Product or related software or technology for any military purposes, including without limitation, for the design, development, use, stockpiling or manufacturing of nuclear, chemical, or biological weapons or missile technology products (mass destruction weapons). Product and related software and technology may be controlled under the applicable export laws and regulations including, without limitation, the Japanese Foreign Exchange and Foreign Trade Law and the U.S. Export Administration Regulations. Export and re-export of Product or related software or technology are strictly prohibited except in compliance with all applicable export laws and regulations.
- Please contact your TOSHIBA sales representative for details as to environmental matters such as the RoHS compatibility of Product. Please use Product in compliance with all applicable laws and regulations that regulate the inclusion or use of controlled substances, including without limitation, the EU RoHS Directive. **TOSHIBA ASSUMES NO LIABILITY FOR DAMAGES OR LOSSES OCCURRING AS A RESULT OF NONCOMPLIANCE WITH APPLICABLE LAWS AND REGULATIONS.**

Mouser Electronics

Authorized Distributor

Click to View Pricing, Inventory, Delivery & Lifecycle Information:

Toshiba:

[TB6588FG\(O,EL,JU\)](#) [TB6588FG,8,EL,JU](#)