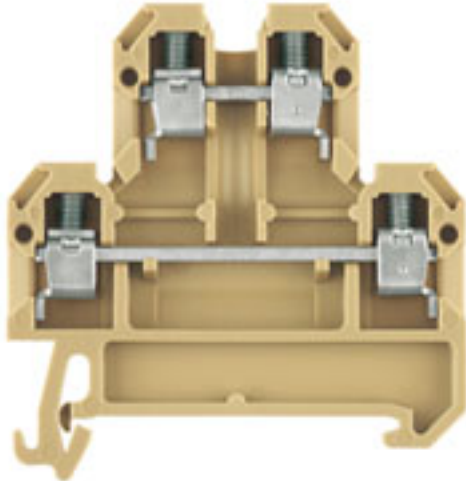

**SAK Series
DK 4/35**

Weidmüller Interface GmbH & Co. KG
Klingenbergstraße 16
D-32758 Detmold
Germany
Fon: +49 5231 1429-0
Fax: +49 5231 14292083
www.weidmueller.com

**Klippon® Connect with clamping yoke Technology**

The high reliability and variety of designs of the terminal blocks with clamping yoke connections make planning easier and optimises operational safety. Klippon® Connect provides a proven response to a range of different requirements.

General ordering data

Type	DK 4/35
Order No.	0527660000
Version	SAK Series, Feed-through terminal, Double-tier terminal, Rated cross-section: 4 mm ² , Screw connection
GTIN (EAN)	4008190082130
Qty.	100 pc(s).

**SAK Series
DK 4/35**

Weidmüller Interface GmbH & Co. KG
 Klingenbergstraße 16
 D-32758 Detmold
 Germany
 Fon: +49 5231 1429-0
 Fax: +49 5231 14292083
 www.weidmueller.com

Technical data**Dimensions and weights**

Width	6 mm	Width (inches)	0.236 inch
Height	50 mm	Height (inches)	1.969 inch
Depth	60.5 mm	Depth (inches)	2.382 inch
Net weight	11.77 g		

Temperatures

Continuous operating temp., min.	-50 °C	Continuous operating temp., max.	100 °C
----------------------------------	--------	----------------------------------	--------

Material data

Material	PA 66	Colour	beige / yellow
UL 94 flammability rating	V-2		

System specifications

Version	Screw connection, for screwable cross- connection, One end without connector	End cover plate required	Yes
Number of potentials	2	Number of levels	2
No. of clamping points per level	2	Number of potentials per tier	1
Levels cross-connected internally	No	PE connection	No
Mounting rail	TS 35	N-function	No
PE function	No	PEN function	No

Additional technical data

Explosion-tested version	No	Number of similar terminals	1
Open sides	right	Type of mounting	Snap-on

CSA rating data

Certificate No. (CSA)	12400-130	Current size C (CSA)	25 A
Voltage size C (CSA)	300 V	Wire cross section max. (CSA)	12 AWG
Wire cross section min. (CSA)	26 AWG		

Conductors for clamping (additional connection)

Conductor cross-section, flexible plus plastic collar DIN 46228/1, further connection, max.	2.5 mm ²
---	---------------------

**SAK Series
DK 4/35**

Weidmüller Interface GmbH & Co. KG
 Klingenbergstraße 16
 D-32758 Detmold
 Germany
 Fon: +49 5231 1429-0
 Fax: +49 5231 14292083
 www.weidmueller.com

Technical data**Conductors for clamping (rated connection)**

Blade size	0.6 x 3.5 mm	Clamping range, rated connection, max.	6 mm ²
Clamping range, rated connection, min.	0.13 mm ²	Clamping screw	M 3
Connection direction		Cross-section for connected conductor, finely stranded with wire-end ferrules and plastic collars DIN 46228/4, rated connection, min.	0.5 mm ²
	on side	Number of connections	4
Gauge to IEC 60947-1	A3	Tightening torque, max.	0.8 Nm
Stripping length	8 mm	Torque level with DMS electric screwdriver	2
Tightening torque, min.	0.5 Nm	Twin wire-end ferrules, min.	0.5 mm ²
Twin wire-end ferrules, max.	1.5 mm ²	Wire connection cross section AWG, max.	AWG 12
Type of connection	Screw connection	Wire connection cross section, finely stranded with wire-end ferrules DIN 46228/1, rated connection, max.	2.5 mm ²
Wire connection cross section AWG, min.	AWG 26	Wire connection cross section, finely stranded, max.	4 mm ²
Wire connection cross section, finely stranded with wire-end ferrules DIN 46228/1, rated connection, min.	0.5 mm ²	Wire connection cross section, solid core, min. rated connection	0.5 mm ²
Wire connection cross section, solid core max. rated connection	6 mm ²	Wire connection cross section, stranded, rated connection, min.	0.5 mm ²
Wire connection cross section, stranded, rated connection, max.	4 mm ²	Wire connection cross-section, finely stranded, min.	0.5 mm ²
Wire connection cross-section, finely stranded with wire-end ferrules and plastic collars DIN 46228/4, rated connection, max.	2.5 mm ²		

Rating data

Rated cross-section	4 mm ²	Rated voltage	500 V
Rated current	32 A	Current at maximum wires	41 A
Standards	IEC 60947-7-1	Volume resistance according to IEC 60947-7-x	1 mΩ
Rated impulse withstand voltage	6 kV	Pollution severity	3

UL rating data

Certificate No. (UR)	E60693	Conductor size Factory wiring max. (UR)	12 AWG
Conductor size Factory wiring min. (UR)	26 AWG	Conductor size Field wiring max. (UR)	12 AWG
Conductor size Field wiring min. (UR)	22 AWG	Current size C (UR)	27 A
Voltage size C (UR)	300 V		

Classifications

ETIM 3.0	EC000897	ETIM 4.0	EC000897
ETIM 5.0	EC000897	ETIM 6.0	EC000897
UNSPSC	30-21-18-11	eClass 5.1	27-14-11-20
eClass 6.2	27-14-11-20	eClass 7.1	27-14-11-27
eClass 8.1	27-14-11-20	eClass 9.0	27-14-11-20
eClass 9.1	27-14-11-20		

Product information

Descriptive text technical data With twin wire-end ferrules ZH 0.5 to ZH 2.5, the rated voltage is 690 V.

Data sheet**SAK Series**
DK 4/35**Weidmüller Interface GmbH & Co. KG**
Klingenbergstraße 16
D-32758 Detmold
Germany
Fon: +49 5231 1429-0
Fax: +49 5231 14292083
www.weidmueller.com**Technical data****Approvals**

Approvals



ROHS

Conform

Downloads

Engineering data

[EPLAN_WSCAD](#)

Declaration of Conformity

[DE_PT1301_20160418_088_ISSUE01.pdf](#)

SAK Series DK 4/35

Weidmüller Interface GmbH & Co. KG
 Klingenbergstraße 16
 D-32758 Detmold
 Germany
 Fon: +49 5231 1429-0
 Fax: +49 5231 14292083
 www.weidmueller.com

Accessories

Plus



The Dekafix (DEK) marker is the universal marker for all conductor and plug-in connectors as well as for electronic sub-assemblies. The system is ideal for short number sequences and covers a wide range of ready-printed markers.

Strips for fast installation in only one work step. The printing is easy to read, rich in contrast and available in various widths.

- Large range of ready-to-use markers
- Strips for fast installation
- Terminal markers, suitable for all Weidmüller cable connectors
- Available as blank MultiCard or with standard printing

General ordering data

Type	Order No.	Version	GTIN (EAN)	Qty.
DEK 5/6 PLUS	1011320000	Dekafix, Terminal marker,	4032248717644	1,000 pc(s).
MC NE WS		5 x 6 mm, Pitch in mm (P): 6.00 Weidmueller, White		

Blank



The Dekafix (DEK) marker is the universal marker for all conductor and plug-in connectors as well as for electronic sub-assemblies. The system is ideal for short number sequences and covers a wide range of ready-printed markers.

Strips for fast installation in only one work step. The printing is easy to read, rich in contrast and available in various widths.

- Large range of ready-to-use markers
- Strips for fast installation
- Terminal markers, suitable for all Weidmüller cable connectors
- Available as blank MultiCard or with standard printing

General ordering data

Type	Order No.	Version	GTIN (EAN)	Qty.
DEK 5/6 MC NE BR	1454900000	Dekafix, Terminal marker, 5 x 6 mm, Pitch in mm (P): 6.00 Weidmueller, Brown	4050118323313	1,000 pc(s).
DEK 5/6 MC NE GN	1238310000	Dekafix, Terminal marker, 5 x 6 mm, Pitch in mm (P): 6.00 Weidmueller, Green	4050118271812	1,000 pc(s).
DEK 5/6 MC NE BL	1238290000	Dekafix, Terminal marker, 5 x 6 mm, Pitch in mm (P): 6.00 Weidmueller, Blue	4050118267327	1,000 pc(s).
2014-12-31TODERBYG-OR	1912090000	Dekafix, Terminal marker, 5 x 6 mm, Pitch in mm (P): 6.00 Weidmueller, Orange	4032248540525	1,000 pc(s).

**SAK Series
DK 4/35**

Weidmüller Interface GmbH & Co. KG
Klingenbergstraße 16
D-32758 Detmold
Germany
Fon: +49 5231 1429-0
Fax: +49 5231 14292083
www.weidmueller.com

Accessories

DEK 5/6 MC 1238280000 NE GE	Dekafix, Terminal marker, 5 x 6 mm, Pitch in mm (P): 6.00 Weidmueller, Yellow	4050118038750 1,000 pc(s).
DEK 5/6 MC 1609820000 NE WS	Dekafix, Terminal marker, 5 x 6 mm, Pitch in mm (P): 6.00 Weidmueller, White	4008190203436 1,000 pc(s).
DEK 5/6 MC 1238330000 NE GR	Dekafix, Terminal marker, 5 x 6 mm, Pitch in mm (P): 6.00 Weidmueller, Grey	4050118323306 1,000 pc(s).

QB

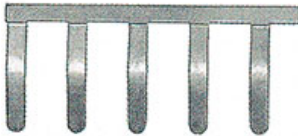

Klippon® Connect with clamping yoke Technology

The high reliability and variety of designs of the terminal blocks with clamping yoke connections make planning easier and optimises operational safety. Klippon® Connect provides a proven response to a range of different requirements.

General ordering data

Type	Order No.	Version	GTIN (EAN)	Qty.
QB 75/6.2/9/ WI	0526400000	SAK Series, Cross- connector, for cross- connection link, No. of poles: 75	4008190099923	10 pc(s).
QB 75/6.2/15	0535200000	SAK Series, Cross- connector, for cross- connection link, No. of poles: 75	4008190179168	10 pc(s).

Custom printing



The Dekafix (DEK) marker is the universal marker for all conductor and plug-in connectors as well as for electronic sub-assemblies. The system is ideal for short number sequences and covers a wide range of ready-printed markers.

Strips for fast installation in only one work step. The printing is easy to read, rich in contrast and available in various widths.

- Large range of ready-to-use markers
- Strips for fast installation
- Terminal markers, suitable for all Weidmüller cable connectors
- Available as blank MultiCard or with standard printing

General ordering data

Type	Order No.	Version	GTIN (EAN)	Qty.
DEK 5/6 MC SDR	1609830000	Dekafix, Terminal marker, 5 x 6 mm, Pitch in mm	4008190456603	200 pc(s).

**SAK Series
DK 4/35**

Weidmüller Interface GmbH & Co. KG
Klingenbergstraße 16
D-32758 Detmold
Germany
Fon: +49 5231 1429-0
Fax: +49 5231 14292083
www.weidmueller.com

Accessories

	(P): 6.00 Weidmueller, To customer specification
DEK 5/6 PLUS 1038650000	Dekafix, Terminal marker, 4032248767908 200 pc(s).
MC SDR	5 x 6 mm, Pitch in mm (P): 6.00 Weidmueller, To customer specification

Connection sleeves



VH 12/4.9/3.3 024900

Klippon® Connect with clamping yoke Technology

The high reliability and variety of designs of the terminal blocks with clamping yoke connections make planning easier and optimises operational safety. Klippon® Connect provides a proven response to a range of different requirements.

General ordering data

Type	Order No.	Version	GTIN (EAN)	Qty.
VH 10/4/2.8 AKZ4	0446600000	SAK Series, Connecting sleeve, for cross-connection link, No. of poles: 1	4008190176211	50 pc(s).

Test plug

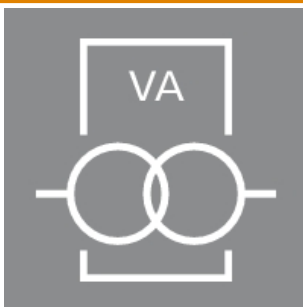

Current and voltage transformer wiring

Our test disconnect terminal blocks featuring spring and screw connection technology allow you to create all the important converter circuits for measuring current, voltage and power in a safe and sophisticated way.

General ordering data

Type	Order No.	Version	GTIN (EAN)	Qty.
PS 2.3 RT	0180400000	Accessories, Test plug	4008190060121	20 pc(s).

**SAK Series
DK 4/35**

Weidmüller Interface GmbH & Co. KG
 Klingenbergstraße 16
 D-32758 Detmold
 Germany
 Fon: +49 5231 1429-0
 Fax: +49 5231 14292083
 www.weidmueller.com

Accessories
DEK 5/6

WS/ DEK

MultiMark DEK/WS connector markers use an innovative composite material made from two components. The hard base contour of the marker snaps securely into the connector. The elastic surface finish makes the marker easy to mount. This specially punched material enables the strips to be stretched to accommodate the slight variations in spacing that tend to add up, especially with long terminal blocks. Another advantage: the excellent printability of the surface material guarantees durable and wear-resistant labelling. A print resolution of 300 dpi also produces a very legible script.

Your benefits with MultiMark

- Compatible with W, Z, P and SAK series terminal blocks
- Firm hold and durable printing
- Continuous strips save installation time
- Easy mounting thanks to an innovative composite material
- Space for multi-line printing

General ordering data

Type	Order No.	Version	GTIN (EAN)	Qty.
DEK 5/6 MM WS	2007120000	Dekafix, Terminal marker, 5 x 6 mm, Weidmueller, White	4050118392104	600 pc(s).

Locking tabs

Klippon® Connect with clamping yoke Technology

The high reliability and variety of designs of the terminal blocks with clamping yoke connections make planning easier and optimises operational safety. Klippon® Connect provides a proven response to a range of different requirements.

General ordering data

Type	Order No.	Version	GTIN (EAN)	Qty.
VL 2 SAK4	0197000000	SAK Series, Cross-connection lug, for cross-connection link, No. of poles: 2	4008190000271	50 pc(s).
VL 2 AKZ4/ DK4	0446700000	SAK Series, Cross-connection lug, for cross-connection link, No. of poles: 2	4008190055486	50 pc(s).

**SAK Series
DK 4/35**

Weidmüller Interface GmbH & Co. KG
Klingenbergstraße 16
D-32758 Detmold
Germany
Fon: +49 5231 1429-0
Fax: +49 5231 14292083
www.weidmueller.com

Accessories

Small partition



Klippon® Connect with clamping yoke Technology
The high reliability and variety of designs of the terminal blocks with clamping yoke connections make planning easier and optimises operational safety. Klippon® Connect provides a proven response to a range of different requirements.

General ordering data

Delivery status	Available until	Type	Order No.	Version	GTIN (EAN)	Qty.
This article will no longer be available in the future.	2017-11-30T00:00:00+01:00	TSCH 6 DKI S4	0190260000	SAK Series, Small partition, Beige, 5 mm	4008190051075	100 pc(s).
TSCH 4 AKZ4 0363360000		SAK Series, Small partition, 4008190136680 100 pc(s). Beige, 6 mm				

End bracket



Klippon® Connect with clamping yoke Technology
The high reliability and variety of designs of the terminal blocks with clamping yoke connections make planning easier and optimises operational safety. Klippon® Connect provides a proven response to a range of different requirements.

General ordering data

Type	Order No.	Version	GTIN (EAN)	Qty.
EW 35	0383560000	Accessories, End bracket	4008190181314	50 pc(s).
EWK 1	0206160000	Accessories, End bracket	4008190080020	50 pc(s).

**SAK Series
DK 4/35**

Weidmüller Interface GmbH & Co. KG
Klingenbergstraße 16
D-32758 Detmold
Germany
Fon: +49 5231 1429-0
Fax: +49 5231 14292083
www.weidmueller.com

Accessories

Partition plates



Klippon® Connect with clamping yoke Technology

The high reliability and variety of designs of the terminal blocks with clamping yoke connections make planning easier and optimises operational safety. Klippon® Connect provides a proven response to a range of different requirements.

General ordering data

Type	Order No.	Version	GTIN (EAN)	Qty.
WTW EN	1058800000	W-Series, Separation plate	4008190140175	20 pc(s).

Insulation profiles



Klippon® Connect with clamping yoke Technology

The high reliability and variety of designs of the terminal blocks with clamping yoke connections make planning easier and optimises operational safety. Klippon® Connect provides a proven response to a range of different requirements.

General ordering data

Type	Order No.	Version	GTIN (EAN)	Qty.
ISPF QB75 BL	0526780000	Accessories, Insulation profile	4008190093105	10 pc(s).
ISPF QB75 RT	0526760000	Accessories, Insulation profile	4008190157821	10 pc(s).
ISPF QB75 SW	0526700000	Accessories, Insulation profile	4008190093723	10 pc(s).

**SAK Series
DK 4/35**

Weidmüller Interface GmbH & Co. KG
 Klingenbergstraße 16
 D-32758 Detmold
 Germany
 Fon: +49 5231 1429-0
 Fax: +49 5231 14292083
 www.weidmueller.com

Accessories
End plates

Klippon® Connect with clamping yoke Technology

The high reliability and variety of designs of the terminal blocks with clamping yoke connections make planning easier and optimises operational safety. Klippon® Connect provides a proven response to a range of different requirements.

General ordering data

Type	Order No.	Version	GTIN (EAN)	Qty.
AP DK4	0359260000	SAK Series, End plate, 1.5 mm, Beige, Direct mounting	4008190012991	20 pc(s).
AP DK4/380 Q	0438560000	SAK Series, End plate, 1.5 mm, Beige, Direct mounting	4008190133351	20 pc(s).
AP DK4S	0631360000	SAK Series, End plate, 1.5 mm, Beige, Direct mounting	4008190101329	20 pc(s).
AP DK4Q	1397160000	SAK Series, End plate, 1.5 mm, Beige, Direct mounting	4008190125899	20 pc(s).
AP DK4Q BL	1397180000	SAK Series, End plate, 1.5 mm, Blue, Direct mounting	4008190171728	20 pc(s).
AP DK4 BL	0359280000	SAK Series, End plate, 1.5 mm, Blue, Direct mounting	4008190031213	20 pc(s).

Non-insulated sockets

Klippon® Connect with clamping yoke Technology

The high reliability and variety of designs of the terminal blocks with clamping yoke connections make planning easier and optimises operational safety. Klippon® Connect provides a proven response to a range of different requirements.

General ordering data

Type	Order No.	Version	GTIN (EAN)	Qty.
STB 8.5/5/2.3/ M3 SAK2.5	0280600000	Accessories, Socket	4008190023188	50 pc(s).
STB 8.5/ D4/2.3/M2.5 AKZ	0215700000	Accessories, Socket	4008190184872	50 pc(s).
STB 8.5/ D4.5/2/M3 SAKT4	0244600000	SAK Series, Socket	4008190103828	50 pc(s).

**SAK Series
DK 4/35**

Weidmüller Interface GmbH & Co. KG
Klingenbergstraße 16
D-32758 Detmold
Germany
Fon: +49 5231 1429-0
Fax: +49 5231 14292083
www.weidmueller.com

Accessories

Partition plates

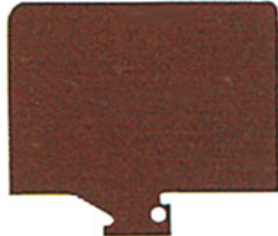

Klippon® Connect with clamping yoke Technology

The high reliability and variety of designs of the terminal blocks with clamping yoke connections make planning easier and optimises operational safety. Klippon® Connect provides a proven response to a range of different requirements.

General ordering data

Type	Order No.	Version	GTIN (EAN)	Qty.
TW SAKS2 HP/DBR/2	0607000000	SAK Series, Separation plate, 2 mm, Dark brown, Used between terminals	4008190002732	20 pc(s).

End plates



Klippon® Connect with clamping yoke Technology

The high reliability and variety of designs of the terminal blocks with clamping yoke connections make planning easier and optimises operational safety. Klippon® Connect provides a proven response to a range of different requirements.

General ordering data

Type	Order No.	Version	GTIN (EAN)	Qty.
WAP WDK2.5	1059100000	W-Series, End plate	4008190101954	20 pc(s).

Q / AKZ



Klippon® Connect with clamping yoke Technology

The high reliability and variety of designs of the terminal blocks with clamping yoke connections make planning easier and optimises operational safety. Klippon® Connect provides a proven response to a range of different requirements.

General ordering data

Type	Order No.	Version	GTIN (EAN)	Qty.
Q 2 AKZ1.5	0368200000	SAK Series, Cross- connector, for cross- connection link, No. of poles: 2	4008190149987	50 pc(s).

SAK Series DK 4/35

Weidmüller Interface GmbH & Co. KG
 Klingenbergstraße 16
 D-32758 Detmold
 Germany
 Fon: +49 5231 1429-0
 Fax: +49 5231 14292083
 www.weidmueller.com

Accessories

Q 3 AKZ4	0336500000	SAK Series, Cross-connector, for cross-connection link, No. of poles: 3	4008190121730 50 pc(s).
Q 4 AKZ4	0336600000	SAK Series, Cross-connector, for cross-connection link, No. of poles: 4	4008190096656 50 pc(s).
Q 10 AKZ4	0368600000	SAK Series, Cross-connector, for cross-connection link, No. of poles: 10	4008190056766 20 pc(s).
Q 10 AKZ1.5	0368500000	SAK Series, Cross-connector, for cross-connection link, No. of poles: 10	4008190159481 20 pc(s).
Q 10 AKZ4SS	0369300000	SAK Series, Cross-connector, for cross-connection link, No. of poles: 10	4008190065744 20 pc(s).
Q 4 AKZ1.5	0368400000	SAK Series, Cross-connector, for cross-connection link, No. of poles: 4	4008190153892 50 pc(s).
Q 2 AKZ4SS	0369000000	SAK Series, Cross-connector, No. of poles: 2	4008190143589 50 pc(s).
Q 2 AKZ4	0336400000	SAK Series, Cross-connector, for cross-connection link, No. of poles: 2	4008190037680 50 pc(s).
Q 3 AKZ1.5	0368300000	SAK Series, Cross-connector, for cross-connection link, No. of poles: 3	4008190074913 50 pc(s).

Covers



Klippon® Connect with clamping yoke Technology

The high reliability and variety of designs of the terminal blocks with clamping yoke connections make planning easier and optimises operational safety. Klippon® Connect provides a proven response to a range of different requirements.

General ordering data

Type	Order No.	Version	GTIN (EAN)	Qty.
AD 4 AKZ4	0303400000	SAK Series, cover plate, Yellow, 20 mm	4008190068158 50 pc(s).	

**SAK Series
DK 4/35**

Weidmüller Interface GmbH & Co. KG
Klingenbergstraße 16
D-32758 Detmold
Germany
Fon: +49 5231 1429-0
Fax: +49 5231 14292083
www.weidmueller.com

Accessories

AD 3 SAK2.5 [0297900000](#) SAK Series, cover plate, 4008190038229 50 pc(s).
Yellow, 18 mm

Insulation sleeve



Klippon® Connect with clamping yoke Technology
The high reliability and variety of designs of the terminal blocks with clamping yoke connections make planning easier and optimises operational safety. Klippon® Connect provides a proven response to a range of different requirements.

General ordering data

Type	Order No.	Version	GTIN (EAN)	Qty.
IH 2.8 DB	0386060000	W-Series, Insulating sleeve	4008190043414	100 pc(s).
IH 6.3 WEM GE	0386260000	W-Series, Insulating sleeve	4008190164256	100 pc(s).

QB RA



Klippon® Connect with clamping yoke Technology
The high reliability and variety of designs of the terminal blocks with clamping yoke connections make planning easier and optimises operational safety. Klippon® Connect provides a proven response to a range of different requirements.

General ordering data

Type	Order No.	Version	GTIN (EAN)	Qty.
QB 2 WI RA6 IS	0482700000	SAK Series, Cross-connector, for cross-connection link, No. of poles: 2	4008190166021	50 pc(s).
QB 3 WI RA6 IS	0482800000	SAK Series, Cross-connector, for cross-connection link, No. of poles: 3	4008190145217	50 pc(s).
QB 4 WI RA6 IS	0482900000	SAK Series, Cross-connector, for cross-connection link, No. of poles: 4	4008190086169	50 pc(s).

Addresses worldwide

Let's connect.

- AE United Arab Emirates**
Weidmüller Middle East FZE
Warehouse Q3-79
SAIF-Zone
P.O. BOX 8591
Sharjah
Telephone number +971 65572723
Fax number +971 65572724
wme.info@weidmueller.com
- AF Afghanistan**
Representative Office

AF 11050 Beograd
Telephone number +381 11 2885 274
Fax number +381 11 2885 274
zoran.rabrenovic@weidmueller.com
- AO Angola**
Please contact
Phambili Interface
South Africa
- AR Argentina**
CPI SA
Bauness 2660
C1431DOF Buenos Aires
Telephone number +54 11 4523 8008
Fax number +54 11 4522 0546
info@cpi.com.ar
www.cpi.com.ar
- AT Austria**
Weidmüller GmbH
IZ NOE Süd, Str. 2b, Obj M59,
2355 Wiener Neudorf
Telephone number +43 2236 67080
Fax number +43 2236 6708-899
office.at@weidmueller.com
www.weidmueller.com
- AU Australia**
Weidmüller Pty. Ltd.
PO BOX 6944
Huntingwood 2148
Huntingwood Drive 43
Huntingwood NSW 2148
Telephone number +61 2 9671 9999
Fax number +61 2 9671 9911
info@weidmuller.com.au
www.weidmuller.com.au
- AZ Azerbaijan**
Representative Office
Weidmüller Interface
Demirchi Tower, 4th floor
37, Khojali ave.
AZ 1025 Baku
Telephone number +994 12 488 80 36
Fax number +994 12 488 80 37
aliyar.hashimli@weidmueller.com
- BA Bosnia and Herzegovina**
Please contact
our Representative Office
Weidmüller Interface GmbH
& Co. KG
Serbia

or
BH ES Elektrosistem d.o.o.
Palih boraca 104
78000 Banja Luka
Telephone number +387 51 420 340
Fax number
elsist@inecco.net
www.elektrosistem.ba
BIG electric d.o.o
Mladena Stojanovića 117A
78000 Banja Luka
Telephone number +387 51926277
Fax number +387 51926277
bigelectric@blic.net
www.bigelectric.ba
- BE Belgium**
Weidmüller Benelux B. V.
Mechelsesteenweg 519 bus
6 en 7
1930 Nossegem
Telephone number +32 2 752 40 70
Fax number +32 2 751 36 06
info@weidmueller.be
www.weidmueller.be
- BG Bulgaria**
Weid-Bul EOOD
Bul. „Kliment Ohridski“ 13
1756 Sofia
Telephone number +359 2 963 2560
Fax number +359 2 963 1098
sofia@weidbul.com
www.weidbul.com
- BH Bahrain**
Khayber Trading Company
P.O.Box 1976
Manama
Telephone number +973 720747
Fax number +973 720331
khayber@batelco.com.bh
- BR Brazil**
Weidmüller Conexel do Brasil
Conexões Elétricas Ltda.
Av. Presidente Juscelino, 642
-Piraporinha
Diadema, São Paulo
09950-370
Telephone number +55 (11) 4366-9600
Fax number +55 (11) 4362-1677
vendas@weidmueller.com.br
www.weidmueller.com.br
- BW Botswana**
Please contact
Phambili Interface
South Africa
- BY Belarus**
TECHNIKON Ltd.
Nezavisimosti pr. 177-9
220125 Minsk
Telephone number +375 17 393-11-77
Fax number +375 17 3930080
wm@technikon.by
- CA Canada**
W Interconnections Canada
Inc.
10 Spy Court
Markham Ontario L3R 5H6
Telephone number +1 (905) 475-1507 Ext. 9836
Fax number +1 (905) 475-2798
support@weidmuller.ca
www.weidmuller.ca
- CG Congo**
Please contact
Phambili Interface
South Africa
- CH Switzerland**
Weidmüller Schweiz AG
Rundbuckstraße 2
8212 Neuhausen am
Rheinfall SH
Telephone number +41 52 674 07 07
Fax number +41 52 674 07 08
info@weidmueller.ch
www.weidmueller.ch
- CL Chile**
CPI CHILE LTDA
Av. Presidente Frei Montalva
6001, 47 complejo el cortijo
Santiago - Conchalí
Telephone number +562 963 8440
Fax number +562 963 8440
cpi@cpichile.cl
www.cpichile.cl
- CN China**
Weidmüller Interface
(Shanghai) Co. Ltd.
100 Yutong Road
25 F. BM Intercontinental
Business Center
200070 Shanghai
Telephone number +86 21-22195008
Fax number +86 21-22195009
customer.hotline@weidmueller.com.cn
www.weidmueller.com.cn
- CO Colombia**
Automatización Avanzada
S. A.
Carrera 97 No., 24 c - 23
Bodega 4
110911 Bogotá-D.C.
Telephone number +57 (1) 547-8510
Fax number +57 (1) 422-3044
comercial@automatizacionavanzada.com
www.automatizacionavanzada.com
- CR Costa Rica**
ELVATRON S. A.
la Uruca 400 Norte Banco
Costa Rica
San Jose Costa Rica
Telephone number +506 2961-060
Fax number +506 5200-609
dirk.haase@elvatron.com
www.elvatron.com
- CZ Czech Republic**
Weidmüller s.r.o.
Lomnického 5/1705
140 00 Praha 4
Telephone number +420 244 001 400
Fax number +420 244 001 499
office@weidmueller.cz
www.weidmueller.cz
- DE Germany**
Weidmüller GmbH & Co. KG
Ohmstraße 9
32758 Detmold
Postfach 30 54
32720 Detmold
Telephone number +49 5231 1428-0
Fax number +49 5231 14-292083
weidmueller@weidmueller.de
www.weidmueller.de
- DK Denmark**
Weidmüller Danmark
Vallensbækvej 18A
2605 Brøndby
Telephone number +45 27747800
kundeservice@weidmuller.dk
www.weidmuller.dk
- DZ Algeria**
SARL INTER ELECTRIC
1a Angles des Rues Okba Ibn
Nafaa et Hassi Beida
2300 Annaba
Telephone number
Fax number
contact@inter-electric.com
- EC Ecuador**
Elsystec S. A., Electricidad
Sistemas y Tecnología
Vasco de Contreras N35-251
y Mañosa
Quito - Pichincha
Telephone number +593 22456510
Fax number +593 22456755
Elsystec@uio.satnet.net
- EE Estonia**
Please contact
our Representative Office
Weidmüller Interface GmbH
& Co. KG
Latvia

or
SLO Eesti AS

11415 Tallinn
Telephone number +372 6 272 200
Fax number
info@slo.ee

SLO Eesti AS

12618 Tallinn
Telephone number +372 622.9119
Fax number
elit@elit.ee

Soots Interface OÜ
Pärnu mnt 142
11317 Tallinn
Telephone number +372 609 6933
Fax number
info@sootsinterface.ee
www.sootsinterface.ee
- EG Egypt**
Standard Electric (OMEGA)
1, Abdelhamid Badawy Street
Heliopolis
Cairo
Telephone number +202 21805 111
Fax number +202 21805600
stdelec@rite.com
- ES Spain**
Weidmüller, S. A.
Narcis Monturiol 11-13, Pol.
Ind. Sudoeste
8960 Sant Just
Desvern - Barcelona
Telephone number +34 934 803 386
Fax number +34 933 718 055
weidmuller@weidmuller.es
www.weidmuller.es
- FI Finland**
Weidmüller Suomi,
Weidmüller Aktiebolagetin
sivuliike
Koy Plaza Vivace
Äyritie 8C
FI 15100 Vantaa
Telephone number +358 20 7351300
Fax number +358 800 114 667
asiakaspalvelu@weidmuller.fi
www.weidmuller.fi
- FR France**
Weidmüller E. U. R. L.
2 Boulevard de l'Oise
CS 31100 CERGY
95095 CERGY PONTOISE
Cedex
Telephone number +33 1 34 24 55 00
Fax number +33 1 34 24 55 01
mail@weidmuller.fr
- GB Great Britain**
Weidmüller Ltd.
Klippon House
Centurion Court Office Park,
Meridian East, Meridian
Business Park
Leicester
LE19 1TP
Telephone number +44 116 282 3470
Fax number +44 116 289 3582
marketing@weidmuller.co.uk
www.weidmuller.co.uk
- GE Georgia**
Please contact
our Representative Office
Weidmüller Interface
Azerbaijan.
- GH Ghana**
Please contact
our Representative Office
Weidmüller Interface GmbH
& Co. KG
South Africa.
- GR Greece**
G.A. Solutions
Ippokratous 11 Metamorfsi
144 52 Athen
Telephone number +30 210 2823233
Fax number +30 210 2823233
info@weidmuller.gr
www.weidmuller.gr
- GT Guatemala**
Prestelectro, Prestegard
Electro, S.A.
Avenida Petapa 44-22,
Zona 12
Guatemala City
Telephone number +502 2442-3346
Fax number +502 2476-8945
ventas@prestelectro.com
- HK Hong Kong**
Weidmüller (Hong Kong)
Limited Co. Ltd.
Unit 1617, Metropolis Tower
No. 10 Metropolis Drive,
Hungghom, Kowloon
Telephone number +852 3154 8088
Fax number +852 31548099
Info-hk@weidmueller.com.hk
- HR Croatia**
ElektroPARTNER d.o.o.
Slavonska avenija 24/6
HR-10000 Zagreb
Telephone number +385 (1) 6184 793
Fax number +385 (1) 6184 795
elektropartner@zg.t-com.hr
www.elektropartner.hr
- HU Hungary**
Weidmüller Kereskedelmi Kft.
Budapest
Gubacsi út 6.
1097
Telephone number +36 1 382 7700
Fax number +36 1 382 7701
info@weidmueller.hu
www.weidmueller.hu
- ID Indonesia**
PT. Nego Electrindo
Ruko Mega Grosir Cempaka
Mas Blok I No. 20 - 22
Jakarta 10640
Telephone number +62 21 42882266
Fax number +62 21 42882266
sales@negoelectrindo.co.id
- IE Ireland**
Please contact
Weidmüller Ltd.
Great Britain
- IL Israel**
A. U. Shay Ltd.
23/25, Embar Street
49222 Petach-Tikva
P.O. Box 1 00 49
49222 Petach-Tikva
Telephone number +972 3-923-3601
Fax number +972 3-923-4601
shay@uriel-shay.com
www.uriel-shay.com
ATEKA Ltd.
4, Ha Tavor lane Industrial
area Segula
49691 Petach-Tikva
P.O. Box 4710
Petach-Tikva
Telephone number +972 73-200-1311
Fax number +972 3-924 4245
marketing@ateka.co.il
www.ateka.co.il



You can find all Weidmüller addresses and your local contact on the internet at: www.weidmuller.com/countries

Sales company 

Representation abroad 

without representation abroad 

Let's connect.

- IN India**
Representative Office
Weidmüller Electronics India
Pvt. Ltd.
No. 9, Union Street, Off.
Infantry Road
BANGALORE
560 001
Telephone number +91-80-
22860028
wmi@weidmuller.in
www.weidmuller.com
- IR Iran**
Representative Office
Tamin Ehtajat Fanni Tehran
(TAF Co.)
No. 36, West 4th St., Ettehad
Ave. Damavand Rd.
Tehran - 1658674583, Iran
Telephone number +9821
77120809
info@taf-co.com
http://www.taf-co.com
- IS Iceland**
Samey Automation Center
Lyngas 13
210 Garoabaer
Telephone number +354
510 5200
Fax number +354 5 10 5201
Samey@samey.is
www.samey.is
- IT Italy**
Weidmüller S. r.l.
Via Albert Einstein 4
20092 Cinisello
Balsamo Milano
Telephone number +39 02
660681
Fax number +39 02
6124945
weidmuller@weidmuller.it
www.weidmuller.it
- JM Jamaica**
Please contact
W Interconnections Inc.
United States
- JO Jordan**
Billeh Electricals Mat. Co.
PO Box 4343
Amman
Telephone number +962 6
4656 987
Fax number +962 6 4649
216
- JP Japan**
Nihon Weidmüller Co. Ltd.
Sphere Tower Tennoz 2-2-8
Higashi-Shinagawa,
Shinagawa-ku
Tokyo
140-0002
Telephone number +81 3
6711 5300
Fax number +81 3 6711
5333
info@weidmuller.co.jp
www.weidmuller.co.jp
- KE Kenya**
Please contact
our Representative Office
Weidmüller Interface GmbH
& Co. KG
South Africa.
- KG Kyrgyzstan**
Please contact
our Representative Office
Weidmüller Interface
Azerbaijan.
- KR Korea**
Weidmüller Korea Co. Ltd.
9th floor
429, Teheran-ro, Gangnam-Gu
Seoul 135-721
Telephone number +82
2-516-0003
Fax number +82 2-516-0090
info@weidmuller.co.kr
www.weidmuller.co.kr
- KW Kuwait**
Kana Controls General Trading
& Contracting Co. W. L. L.
Al Rai Industrial Area, Plot
28-30, St. 31
13016 Safat
B.P. 25593
Telephone number +965
4741373
Fax number +965 4741537
info@kanacontrols.com
- Petroleum Services Co. W.L.L.
Kuwait Trade Free Zone Area
P.O. Box 4098 Safat 13041
- Telephone
number +96524610801/2/3
ext. 208 II
Fax number +96524613754
psc-systems@petserv.net
- KZ Kazakhstan**
Please contact
Weidmüller Group
Russia
- LB Lebanon**
Progress Engineering &
Trading Enterprises
Al Nahr Street
Beirut 11-1111
Telephone number +961 1
444 664
Fax number +961 1 561 880
progress@inco.com.lb
- LT Lithuania**
Please contact
our Representative Office
Weidmüller Interface GmbH
& Co. KG
Latvia
- or
- ELEKTROS IRANGA
Tinklu g. 29 a
LT-5319 Panevezys
Telephone number +370 (45)
582 828
Fax number +370 (45)
582 727
info@eliranga.lt
- UAB „SLO Lithuania“
Vilkpėdės g. 4
LT-LT-03151 Vilnius
Telephone number +370 5
215 00 70
Fax number +370 5 215
00 71
biuras@slo.lt
- LU Luxembourg**
Please contact
Weidmüller Benelux B. V.
Netherlands
- LV Latvia**
SIA Abi4
Daugavgrivas 49 k3
Riga, LV-1007
Telephone number +371 674
70999
Fax number
abi_4@tvnet.lv
- Representative Office
Weidmüller Interface GmbH
& Co. KG
Udens str. 12-118
Riga, LV-1007
Telephone number +371
29254766
Fax number
lgonis.rudaks@weidmuller.
com
www.weidmuller.com
- MA Morocco**
Sofimed
137, Bd Moulay Ismail Roches
Noires
20290 Casablanca
Telephone number
Fax number
contact@sofimedmaroc.com
- MD Moldova**
Inoxpa Solutions SRL
20, Igor Vieru street
MD-2075 Chisinau
Moldova
Telephone number +373 (22)
866665
Fax number +373 (22)
866663
atiuleanu@gmp-moldova.com
www.gmp-moldova.com
- ME Montenegro**
Please contact
our Representative Office
Weidmüller Interface GmbH
& Co. KG
Serbia.
- MG Madagascar**
Please contact
Phambili Interface
South Africa
- MK Macedonia**
Please contact
our Representative Office
Weidmüller Interface GmbH
& Co. KG
Serbia
- or
- ELEKTRO - SMK dooel
UL. III Makedonska brigada
b.b.
1000 Skopje
Telephone number +389
22460295
Fax number
Elektro-smk@telekabel.net.mk
- MN Mongolia**
Please contact
our Representative Office
Weidmüller Interface
Azerbaijan.
- MT Malta**
E. S. S., Electrical Supplies &
Services Ltd.
San Gwakklin Road
Mriehel
Telephone number +356
21255777
Fax number +356 21255999
robert.agius@ess.com.mt
- MU Mauritius**
Mubelo Electrical Ltd.
Office 26, Gateway building,
St Jean Road
Quatre Bornes
Mauritius
Telephone number +230
4670989
Fax number +230 4654051
richard.mubelo@orange.mu
- MW Malawi**
Please contact
our Representative Office
Weidmüller Interface GmbH
& Co. KG
South Africa.
- MX Mexico**
W Interconnections S. A.
DE C. V.
Blvd. Hermanos Serdán 698,
Col. San Rafael Oriente
72029 Puebla
Telephone number +52 (222)
268 6227
Fax number +52 (222) 286
6242
clientes@weidmuller.com.mx
- MY Malaysia**
Connect Plus Technology
Sdn Bhd
No. 43, Jalan PJS 11/22,
Bandar Sunway
46150 Petaling Jaya
Selangor Darul Ehsan
Telephone number +60 3
5633 7363
Fax number +60 3 5633
6562
paul@cptech.com.my
www.cptech.com.my
- MZ Mozambique**
Please contact
Phambili Interface
South Africa
- NA Namibia**
Please contact
Phambili Interface
South Africa
- NG Nigeria**
Please contact
Weidmüller Interface GmbH
& Co. KG
South Africa
- NL Netherlands**
Weidmüller Benelux B. V.
Franciscusweg 221
1216 SE Hilversum
P.O. Box 1505
1200 BM Hilversum
Telephone number +31 35
626 12 61
Fax number +31 35 623
20 44
info@weidmuller.nl
www.weidmuller.nl
- NO Norway**
Sivilingeniør J.F. Knudtzen AS
Billingstadsetta 97
1396 Billingstad
PO Box 160
1378 Nesbru
Telephone number +47 66
98 33 50
Fax number +47 66 98 09 55
firmapost@jfknudtzen.no
www.jfknudtzen.no
- NZ New Zealand**
Cuthbert S. Steward Ltd.
27 Te Puni Street
Petone
PO Box 38496
Wellington Mail Centre 5054
Telephone number (04) 568
6156
Fax number (09) 489 1752
csi@cuthbertstewart.co.nz
- Cuthbert S. Steward Ltd
4 Fred Thomas Drive
Aon Building, Ground Floor,
South Entry
Takapuna
PO Box 100 338
North Shore City 745
Telephone number (09) 489
1751
Fax number (04) 568 6056
csiak@cuthbertstewart.co.nz
- OM Oman**
DAN INTERNATIONAL LLC.
Ghala St. 111
BP 2901
Seeb
Telephone number +968
5036 77
Fax number +968 5037 55
yedu@danintl.com
- PE Peru**
IMPEXINCA S.A.C.
Calle Ortiz de Zevallos No.
105, Urb. San Antonio
18
Lima, Miraflores
Telephone number +51 1
447 5608
info@impexinca.pe
www.impexinca.pe
J & W CIA. S. A.
Calle 6 Mz. D Lte. 23, Urb.
Ind. Grimanesa
01
Callao
Telephone number +51 1
572 2539
Fax number +51 1 572 0152
contacto@jwcia.com
www.jwcia.com
- PH Philippines**
Enclosure Systems Specialists
Inc.
2276 Don Chino Roces
Avenue Extension
Room 103/105 Narra Building
1231 Makati City
Telephone number +63 2
813 8580
Fax number +63 2 813 8596
sales_encsys@pltdsl.net
www.enclosuresystemsph.
com
- PK Pakistan**
Automation Controls (Pak)
Apartment No. 33 C III,
Chensab Block, Allama Iqbal
Town
Lahore
Telephone number +92 42
37809948
Fax number +92 42
37809950
nadeem@acpak.com.pk
www.acpak.com.pk
- PL Poland**
Weidmüller Sp. z o. o.
ul. Ogrodowa 58
00-876 Warszawa
Telephone number +48 22
510 09 40
Fax number +48 22 510
09 41
biuro@weidmuller.com.pl
www.weidmuller.pl
- PR Puerto Rico**
Please contact
W Interconnections Inc.
United States
- PT Portugal**
Weidmüller Sistemas de
Interface S. A.
Estrada Outeiro Polima, R.
Augusto Dias da Silva, Lote
B - Esc. 2
São Domingos de Rana
2785-515 Abóboda
Telephone number +351 214
459 191
Fax number +351 214
455 871
weidmuller@weidmuller.pt
www.weidmuller.pt
- PY Paraguay**
Please contact
CPI SA
Argentina
- QA Qatar**
Doha Motors
PO Box 145
Telephone number +974
4651441
Fax number +974 4654579
dmtctech@qatar.net.qa
http://www.dohamotorsgroup.
com/td.html
- RO Romania**
Representative Office
Weidmüller Interface GmbH
& Co. KG
Inescu Crum Street, No.
1, 1st Tower, 1st Floor,
Office 4
500446 Brasov - Brasov
Business Park
Telephone number +40 (268)
446 222
Fax number +40 (268)
446 224
claudiu.totea@weidmuller.
com
www.weidmuller.ro
- RS Serbia**
Representative Office
Weidmüller Interface GmbH
& Co. KG
Ustanička 189, III sprat
lokal 7a
11050 Beograd
Telephone number +381
112885274
Fax number +381
112885274
zoran.rabrenovic@
weidmuller.com
- TeLa Elektrik d.o.o.
Ul. Dr. Drage Ljočić 6
Beograd
Telephone number +381 11
2772 415
Fax number +381 11 2772
850
office@tela.rs
www.tela.rs

Addresses worldwide

Let's connect.

RU Russia
Weidmüller Group
7/10 Khlebozavodskiy
Passage,
Moskau
115230
Telephone number +7 495
280 72 71
Fax number +7 495 280
72 71
Info@weidmueller.ru
www.weidmueller.ru

SA Saudi Arabia
Al Abdulkarim Holding Co.
P.O. Box 4
Dammam 31411
Telephone number +966 3
8337 110
Fax number +966 3
8829547
E-mail salehsk@akh.com.sa
www.weidmueller.ae

Saudi Electric Supply
Company (SESCO)
P.O. Box 32 98
Al Khobar 31952
Telephone number +966 3
8829546 Ext. 3030
Fax number
E-mail Safdar.Malik@sescogex.com
www.sescogex.com

SE Sweden
Weidmüller AB
Axel Danielssons väg 271
BOX 31025
SE-200 49 Malmö
Telephone number +46 77-
143 00 44
Fax number +46 40-37 48 60
info@weidmuller.se
www.weidmuller.se

SG Singapore
Weidmüller Pte. Ltd.
70 Bendemeer Road
04-03 Luzerne Building
Singapore 339940
Telephone number +65 6841
53 11
Fax number +65 6841 5377
info@weidmuller.com.sg
www.weidmuller.com.sg

SI Slovenia
Elektrospoji d. o. o.
Stegne 27
SI- 1000 Ljubljana
Osrednjeslovenska
Telephone number +386 1
511 3810
Fax number +386 1 511
1604
info@elektrospoji.si
www.elektrospoji.si

SK Slovakia
ELEKTRIS s.r.o.
Elektrárenská 1
831 04 Bratislava
Telephone number +421
2/4920 0113
Fax number +421 2/4920
0119
bratislava@elektris.sk

SV El Salvador
Prestegard Electro
11 Avenida Norte No. 240
Edificio Salazar No. 2
San Salvador
Telephone number +503
2271 1690
Fax number +503 2221
3851
prestegard@navegante.com.sv

SY Syria
Please contact
Weidmuller Middle East FZE
United Arab Emirates

SZ Swaziland
Please contact
Phambili Interface
South Africa

TH Thailand
Pisanu Engineering Co. Ltd.
Kwang Dingaeng, Khet
Dingaeng
800/2 Soi Trakulsuk, Asoke-
dindaeng Road
Dindaeng, Bangkok
10400
Telephone number +66 2
248 2896
Fax number +662 105 6301
ecsales@pisanu.co.th
www.pisanu.co.th

Representative Office
Weidmüller Pte. Ltd.
37/F, Sathorn Square Building
98 North Sathorn Road
Bangkok, Silom Bangrak
10500
Telephone number +66 2
105 6300
Fax number +66 2 642 9220
info@weidmuller.com.sg

TJ Tajikistan
Please contact
our Representative Office
Weidmüller Interface
Azerbaijan.

TM Turkmenistan
Please contact
our Representative Office
Weidmüller Interface
Azerbaijan.

TN Tunisia
Please contact
Weidmüller E. U. R. L.
France

TR Turkey
Weidmüller Elektronik Ticaret
Ltd. Sirketi
Kavacik Mah. Orhan Veli Kanik
Caddesi 9/1
34810 Beykoz / Istanbul
Telephone number +90 (216)
537 10 70
Fax number +90 (216) 537
10 77
info@weidmuller.com.tr
www.weidmuller.com.tr

TW Taiwan
Please contact
Weidmuller (Hong Kong)
Limited Co. Ltd.
Hong Kong

TZ Tanzania
Please contact
our Representative Office
Weidmüller Interface GmbH
& Co. KG
South Africa.

UA Ukraine
LLC WM UKRAINE
Levanevskogo str. 6
Kiev
3058
Telephone number +38 044
490 32 48
Fax number
info@wm-ua.com.ua
wm-ua.com.ua/

Representative Office
Weidmüller Interface GmbH
& Co. KG
Z. office 303
7-D, Zdolbunivska str.
Kiev, 2081
Telephone number
(mobile) +38 050 440 25 24
info.ua@weidmueller.com

US United States
W Interconnections Inc.
821 Southlake Boulevard
Richmond Virginia 23236
Telephone number +1 (804)
794-2877
Fax number +1 (804) 379-
2593
info@weidmuller.com
www.weidmuller.com

UY Uruguay
REWO Uruguay S. A.
AV. Bolivia 2001Esq
Rocafuerte
11300 Carrasco Montevideo
Telephone number +598
2604 8439
Fax number +598 2604
8439
rewo@rewo Uruguay.com.uy

UZ Republic of Uzbekistan
Please contact
our Representative Office
Weidmüller Interface
Azerbaijan.

VE Venezuela
Somerinca C. A.
Corazon de Jesus - 3ra
Transversal con calle el
Carmen- Los Dos Caminos
Caracas 1070-A
Telephone number +58
2122352748
Fax number +58
2122399341
klocmoeller@cantv.net
www.somerinca.com

VN Vietnam
AUMI Industrial Equipment &
Automation Company Limited
E1, La Thanh Hotel
218 Doi Can Street
Lieu Giai Ward, Ba Dinh
District
Hanoi City
Telephone number +84 4
37 628601
Fax number +84 4
62661391
aumi@aumi.com.vn
www.aumi.com.vn

Representative Office
Weidmüller Pte. Ltd.
Level 16 Saigon Tower
Building
29 Le Duan Street
District 1
Ho Chi Minh
Telephone number +848
3520 7717
Fax number +848 3520
7604
info@weidmuller.com.sg

ZA South Africa
Phambili Interface
PO Box 193
1609 Johannesburg, Edenvale
5 Bundo Road, Sebenza
1610 Johannesburg
Telephone number +27 (11)
4521930
Fax number
info@weidmuller.co.za
www.weidmuller.co.za

Representative Office
Weidmüller Interface GmbH
& Co. KG
210 Amarand
Avenue, Pegasus Building
181 Pretoria, waterkloof Glen
ext 2 -
Telephone number +27 12
003 2906
Fax number +27 (11)
4526455
Jacques.Vosloo@weidmueller.
com
www.weidmueller.com

ZM Zambia
Please contact
Phambili Interface
South Africa

ZW Zimbabwe
Please contact
Phambili Interface
South Africa